



US00D871251S

(12) **United States Design Patent** (10) **Patent No.:** **US D871,251 S**
Jimenez et al. (45) **Date of Patent:** **** Dec. 31, 2019**

(54) **FOOTBALL CROSS**
(71) Applicant: **All in Faith Jewelry, LLC**, Austin, TX (US)
(72) Inventors: **Adam Jimenez**, Waco, TX (US);
Robert Jimenez, Waco, TX (US)
(73) Assignee: **All in Faith LLC**, Austin, TX (US)
(**) Term: **15 Years**

D608,689 S 1/2010 Cerullo et al.
D656,429 S * 3/2012 Cadigan D11/96
D664,887 S * 8/2012 Courtney D11/96
D666,120 S 8/2012 Austin
D688,591 S * 8/2013 Merrell D11/149
D716,687 S * 11/2014 Spencer D11/96
D752,474 S 3/2016 Warner
D786,122 S 5/2017 Jimenez et al.
D795,733 S 8/2017 Small
D843,260 S * 3/2019 Jimenez D11/96
2002/0095952 A1 7/2002 Kelly
(Continued)

(21) Appl. No.: **29/641,765**
(22) Filed: **Mar. 23, 2018**
(51) **LOC (12) Cl.** **11-03**
(52) **U.S. Cl.**
USPC **D11/96**
(58) **Field of Classification Search**
USPC D11/95-100, 105, 106, 108, 110, 116,
D11/132, 222, 226, 228, 233; D14/485,
D14/486; D2/828, 829; D8/387;
D99/27, 34
CPC A44C 7/00; A44C 7/002; H01H 13/70;
Y10S 273/30; A44B 1/14; A44B 1/02;
A44B 1/20; A44B 1/00
See application file for complete search history.

OTHER PUBLICATIONS

All in Faith Pigskin Football Cross Pendant [Jun. 21, 2019] found online [Jun. 21, 2019]—https://www.allinfaith.com/collections/mens-football-jewelry-1/products/mf1-pigskin-football-cross-pendant.*

(Continued)

Primary Examiner — Lakiya G Rogers
Assistant Examiner — John A Voytek
(74) *Attorney, Agent, or Firm* — RM Reed Law PLLC

(57) **CLAIM**

The ornamental design for a football cross, as shown and described.

DESCRIPTION

FIG. 1 depicts a front perspective view of a football cross according to the present disclosure; FIG. 2 depicts a front view of the football cross of FIG. 1; FIG. 3 depicts a rear view of the football cross of FIG. 1; FIG. 4 depicts a left side view of the football cross of FIG. 1; FIG. 5 depicts a right side view of the football cross of FIG. 1; FIG. 6 depicts a top view of the football cross of FIG. 1; and, FIG. 7 depicts a bottom view of the football cross of FIG. 1.

1 Claim, 6 Drawing Sheets

(56) **References Cited**
U.S. PATENT DOCUMENTS

D153,601 S 5/1949 Gresh
D339,916 S 10/1993 Behbahani
D465,432 S 11/2002 Henmi
D487,232 S * 3/2004 Pachachi D11/96
D508,580 S 8/2005 Norris et al.
D511,711 S * 11/2005 Steshik D11/96
D518,754 S 4/2006 Dias
D525,163 S * 7/2006 Balch D11/86
D557,163 S 12/2007 Cerullo et al.
D564,931 S * 3/2008 Tamir D11/7

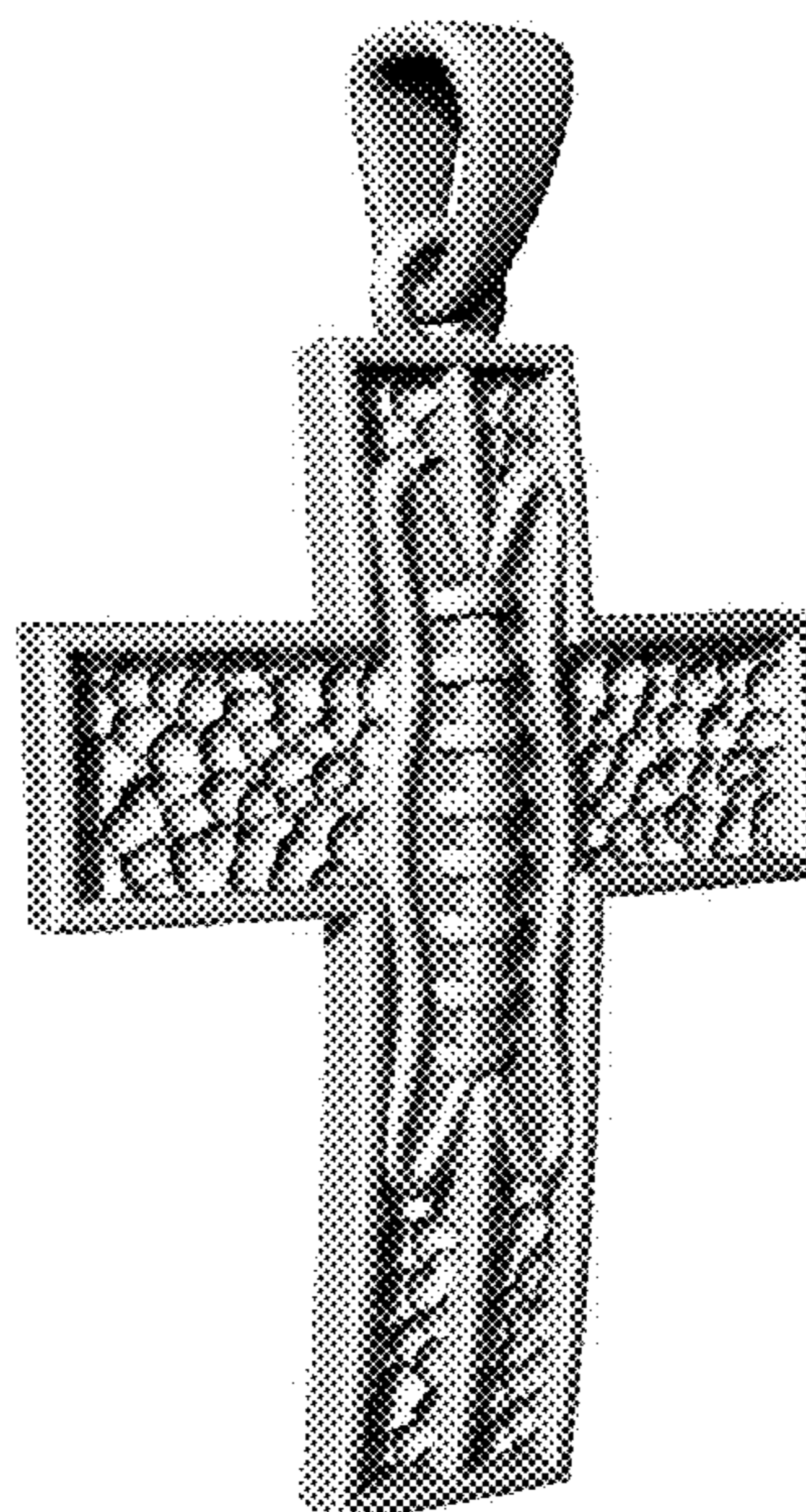

(56)

References Cited

U.S. PATENT DOCUMENTS

2007/0261441 A1 11/2007 Fouzailov
2011/0121971 A1* 5/2011 Ross A47G 33/02
340/541

OTHER PUBLICATIONS

Jimenez, U.S. Appl. No. 29/590,134, filed Jan. 6, 2017.
Jimenez, U.S. Appl. No. 29/627,617, filed Nov. 28, 2017.

* cited by examiner

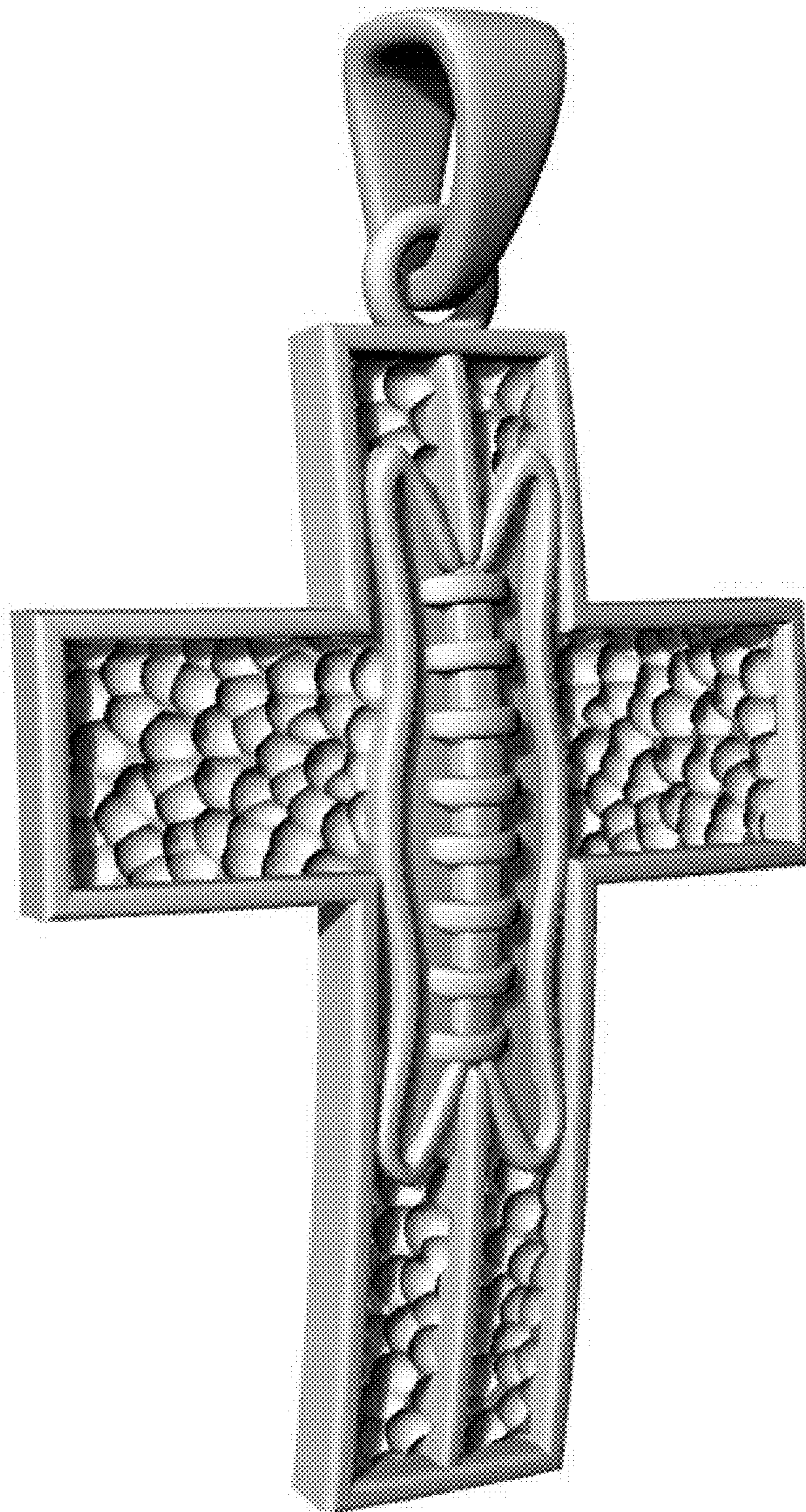

FIG. 1

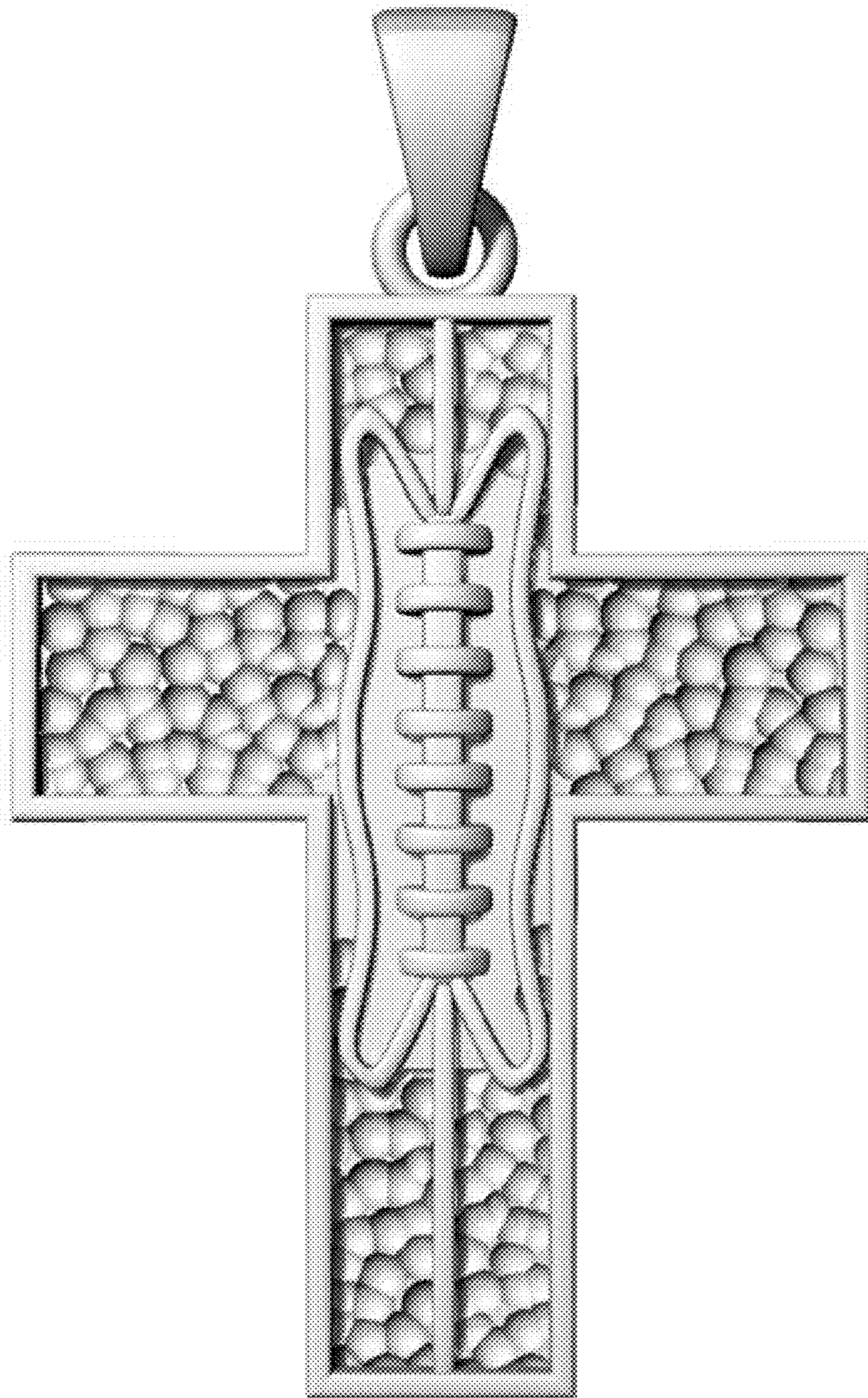

FIG. 2

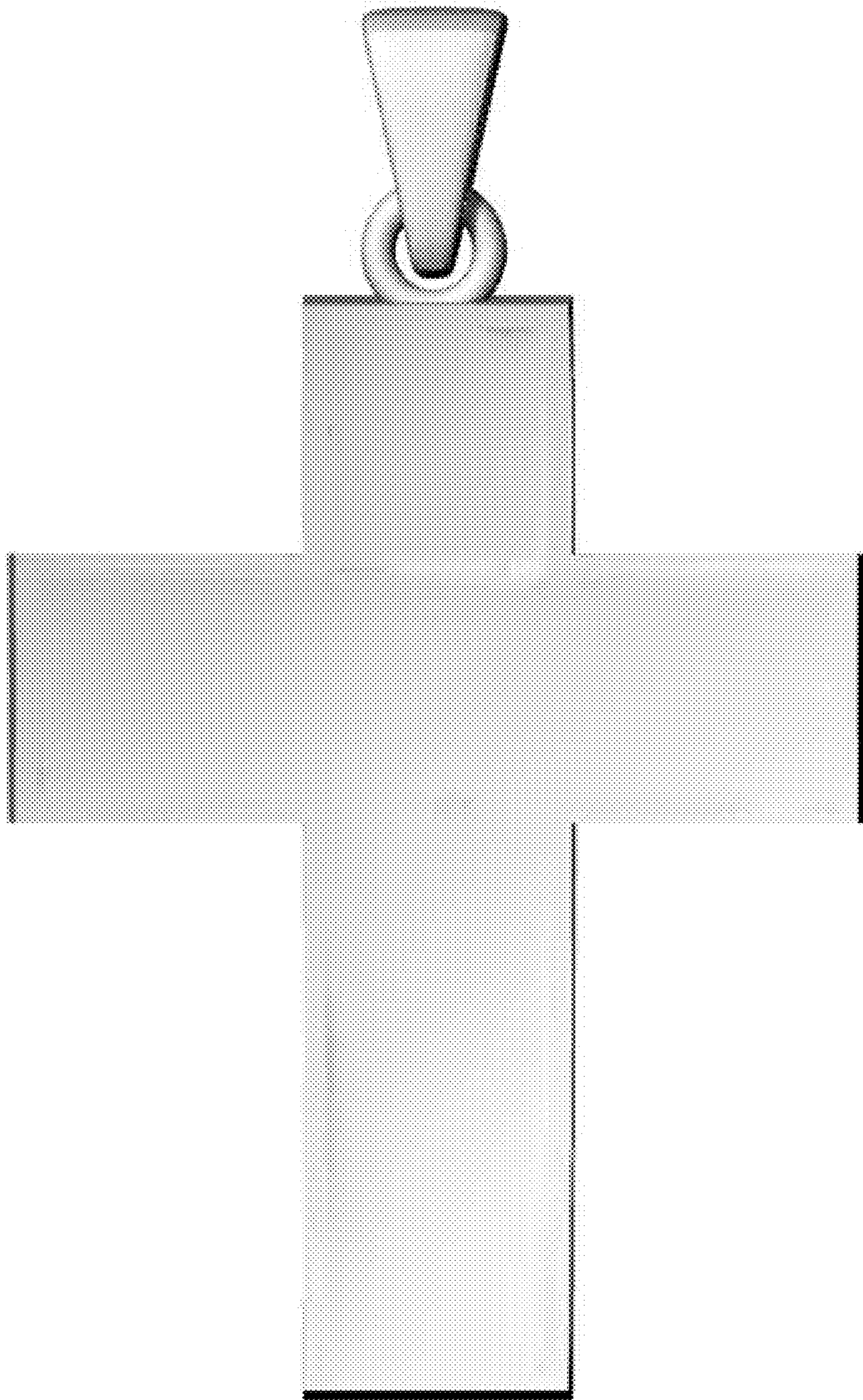

FIG. 3

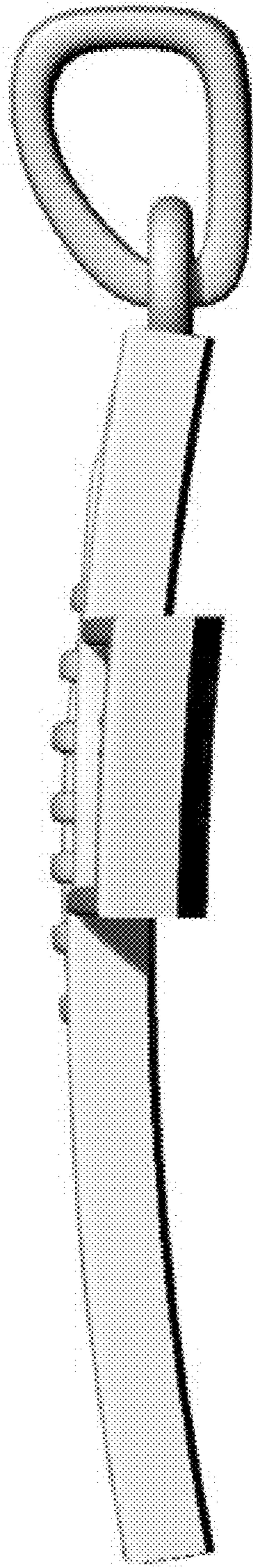

FIG. 4

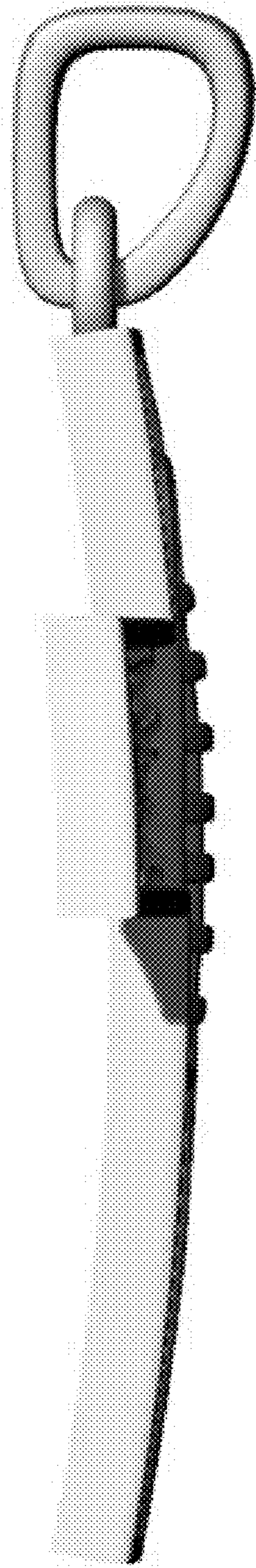

FIG. 5

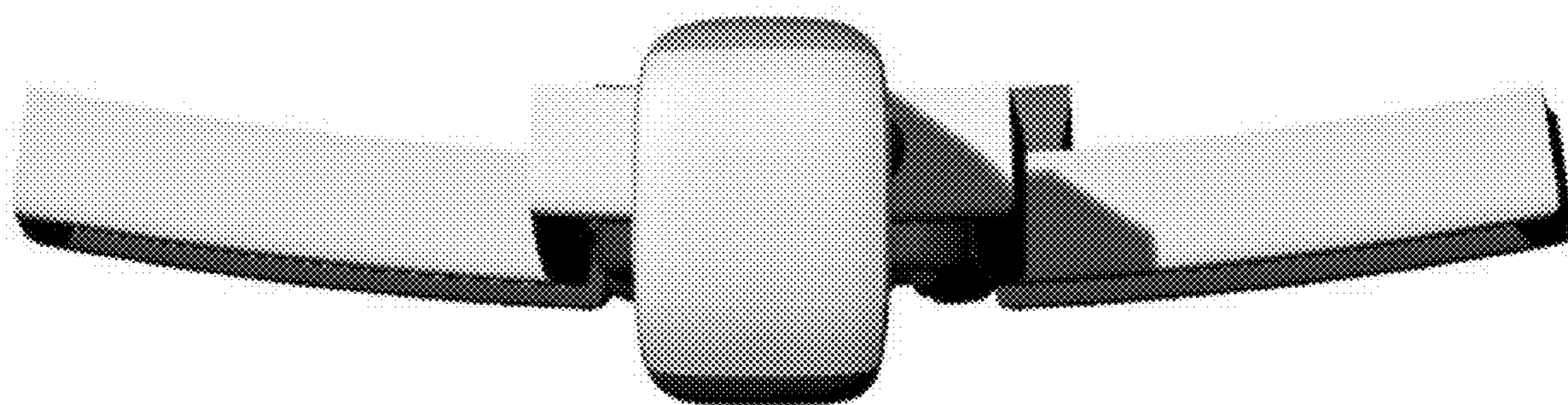

FIG. 6

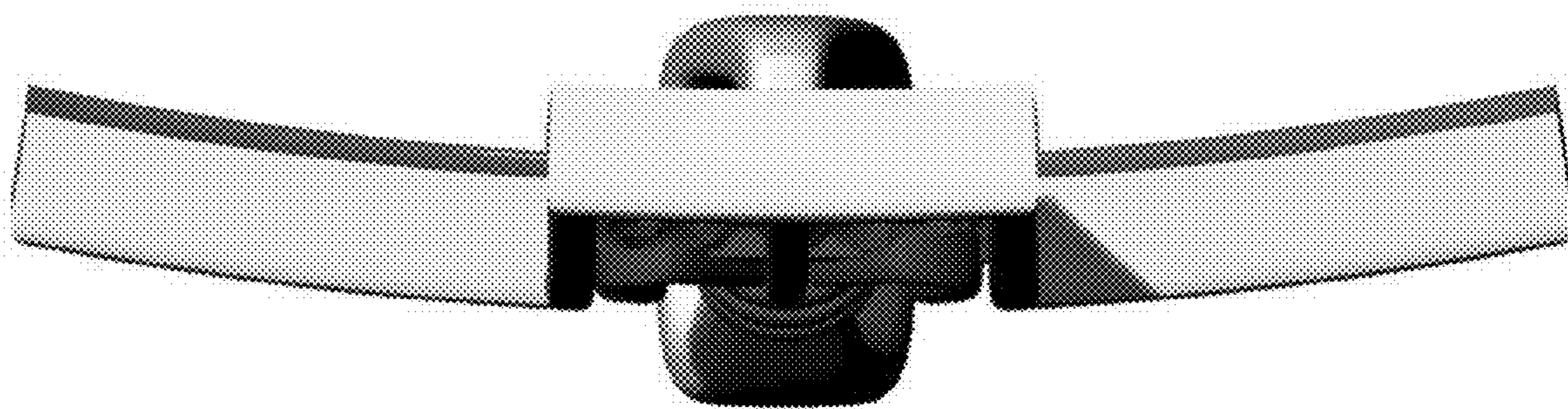

FIG. 7