



US00D871203S

(12) **United States Design Patent**
Koepfel et al.

(10) **Patent No.:** **US D871,203 S**

(45) **Date of Patent:** **** Dec. 31, 2019**

(54) **TRANSACTION CARD PRESENTATION BOX**

(74) *Attorney, Agent, or Firm* — Harrity & Harrity, LLP

(71) Applicant: **Capital One Services, LLC**, McLean, VA (US)

(57) **CLAIM**

The ornamental design of a transaction card presentation box, as shown and described.

(72) Inventors: **Adam Koepfel**, Washington, DC (US);
Molly Johnson, Alexandria, VA (US);
Natasha Jensen, San Francisco, CA (US);
Daniel Clifton, San Francisco, CA (US)

DESCRIPTION

(73) Assignee: **Capital One Services, LLC**, McLean, VA (US)

FIG. 1 is a front, top, left perspective view of a transaction card presentation box in a closed position, showing our new design;

(**) Term: **15 Years**

FIG. 2 is a top view thereof;

(21) Appl. No.: **29/619,378**

FIG. 3 is a bottom view thereof;

(22) Filed: **Sep. 28, 2017**

FIG. 4 is a left side view thereof;

(51) **LOC (12) Cl.** **09-03**

FIG. 5 is a right side view thereof;

(52) **U.S. Cl.**

FIG. 6 is a front side view thereof; and

USPC **D9/414**

FIG. 7 is a back side view thereof.

(58) **Field of Classification Search**

USPC D9/414-420, 432, 423, 426, 440;
D3/203.1, 294; D24/227; D7/624.2

FIG. 8 is a front, top, left perspective view of the transaction card presentation box in a partially open position, and FIG. 9 is a top, right, back perspective view thereof.

(Continued)

FIG. 10 is a front, top, left exploded perspective view of the transaction card presentation box in a partially open position;

(56) **References Cited**

U.S. PATENT DOCUMENTS

D126,124 S * 3/1941 Clemens D9/423
RE24,495 E * 7/1958 Pace B65D 5/46056
229/117.25

FIG. 11 is a top view of FIG. 8;

FIG. 12 is a top view of FIG. 10;

FIG. 13 is a bottom view of FIGS. 8 and 10;

FIG. 14 is a left side view of FIGS. 8 and 10;

FIG. 15 is a right side view of FIGS. 8 and 10;

FIG. 16 is a front side view of FIGS. 8 and 10; and

FIG. 17 is a back side view of FIGS. 8 and 10.

(Continued)

FIG. 18 is a front, top, left perspective view of the transaction card presentation box in fully open position;

FIG. 19 is a front, top, left exploded perspective view thereof;

FIG. 20 is a top view of FIG. 18;

FIG. 21 is a top view without the insert;

FIG. 22 is a bottom view of FIGS. 18 and 19;

FIG. 23 is a left side view of FIGS. 18 and 19;

FIG. 24 is a right side view of FIGS. 18 and 19;

FIG. 25 is a front side view of FIGS. 18 and 19; and,

FIG. 26 is a back side view of the third embodiment shown in FIGS. 18 and 19.

OTHER PUBLICATIONS

Julian Mark Kheel, "Unboxing the Citi Prestige Card (Video)," <http://thepointsguy.com/2017/08/citi-prestige-unboxing-video/>, Aug. 11, 2017, 9 pages.

(Continued)

Primary Examiner — Rhea Shields

(Continued)

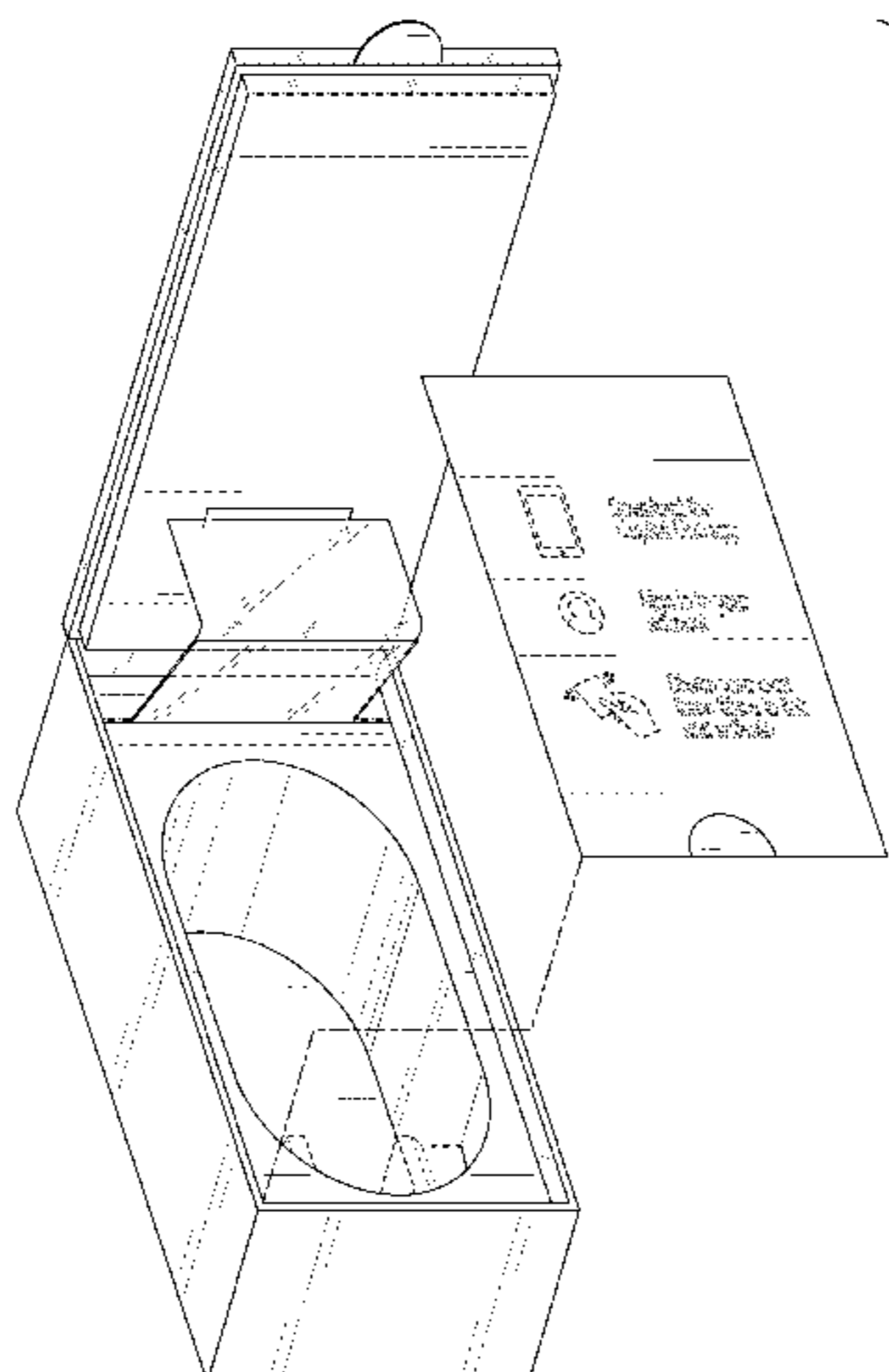

The broken lines are included for the purpose of illustrating portions of the transaction card presentation box and form no part of the claimed design.

1 Claim, 26 Drawing Sheets

(58) Field of Classification Search

CPC B65D 43/16; B65D 5/029; B65D 5/46056;
A45C 11/182

See application file for complete search history.

(56) References Cited

U.S. PATENT DOCUMENTS

D319,785 S *	9/1991	Kilmartin, III	D9/423
6,155,480 A *	12/2000	Botsford	B65D 5/029 221/305
D436,859 S *	1/2001	Botsford	D9/416
D527,255 S *	8/2006	Liebe	D9/440
D531,800 S *	11/2006	Sakaguchi	D3/294
D620,795 S *	8/2010	Andre	D9/432
D623,512 S *	9/2010	Stewart	D9/423

D645,737 S *	9/2011	Oakes	D9/420
D646,158 S *	10/2011	Siqueiros	D9/423
D682,689 S *	5/2013	Kalberer	D9/416
D704,550 S *	5/2014	Mattila	D9/432
D733,314 S *	6/2015	Lui	D24/227
D742,220 S *	11/2015	Eyerman	D9/426
D803,681 S *	11/2017	Yang	D9/432
D805,895 S *	12/2017	Smalley	D9/432
D806,532 S *	1/2018	Richmond	D9/420
D819,439 S *	6/2018	Young	D9/420
9,988,193 B1 *	6/2018	Koeppel	A45C 11/182
D830,789 S *	10/2018	Brooks	D7/624.2
D832,696 S *	11/2018	Balanevsky	D9/423
D834,937 S *	12/2018	McKenzie	D9/432
D841,311 S *	2/2019	Young	D3/203.1
D842,689 S *	3/2019	Sanfilippo	D9/416
2019/0092541 A1 *	3/2019	Koeppel	B65D 43/16

OTHER PUBLICATIONS

AVTProjects, "J.P. Morgan Chase Palladium Credit Card Unboxing Review (Palladium and White Gold not Centurion)," <https://www.youtube.com/watch?v=duasEVnoYmE>, Mar. 29, 2012, 3 pages.

* cited by examiner

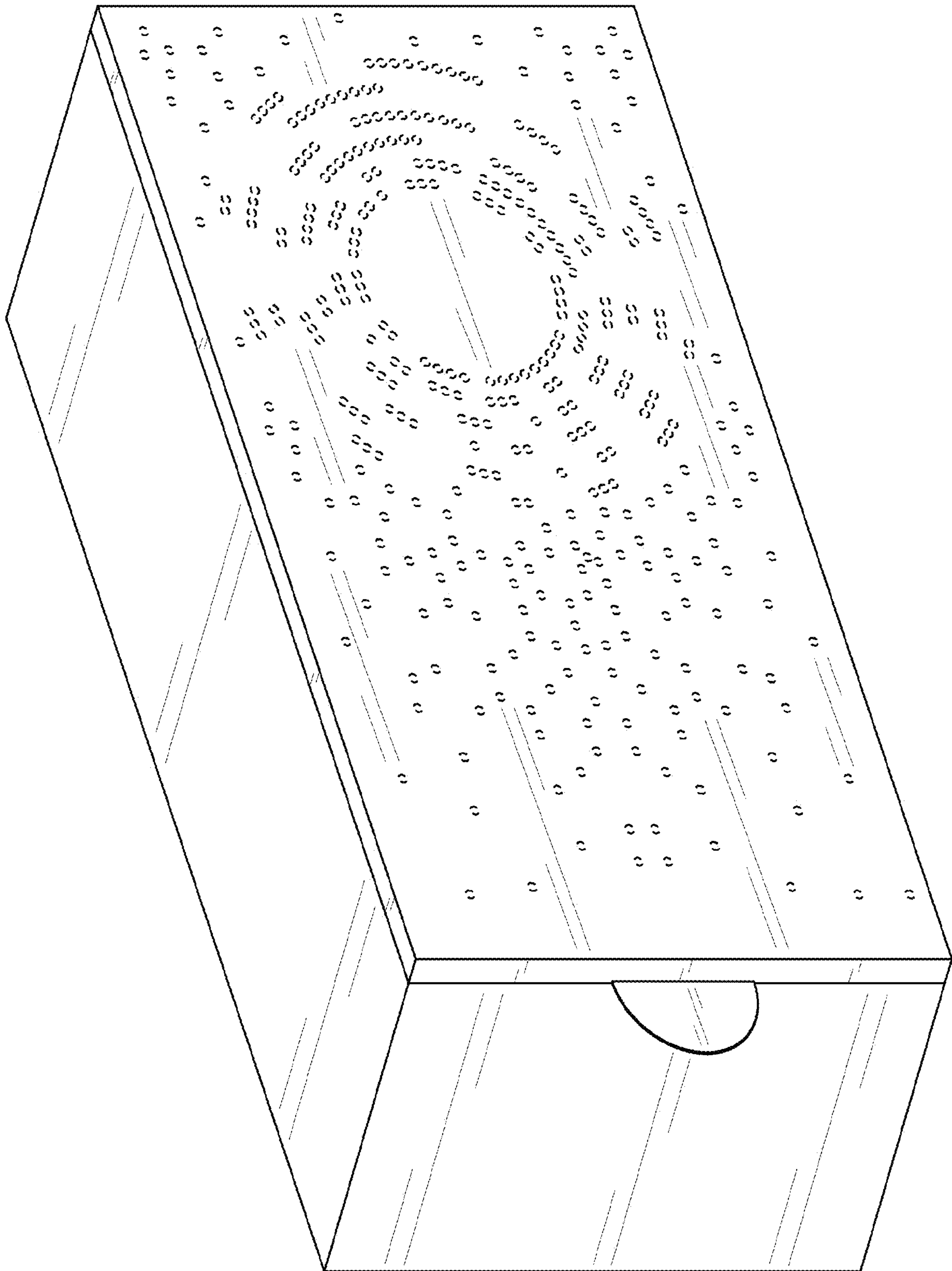

FIG. 1

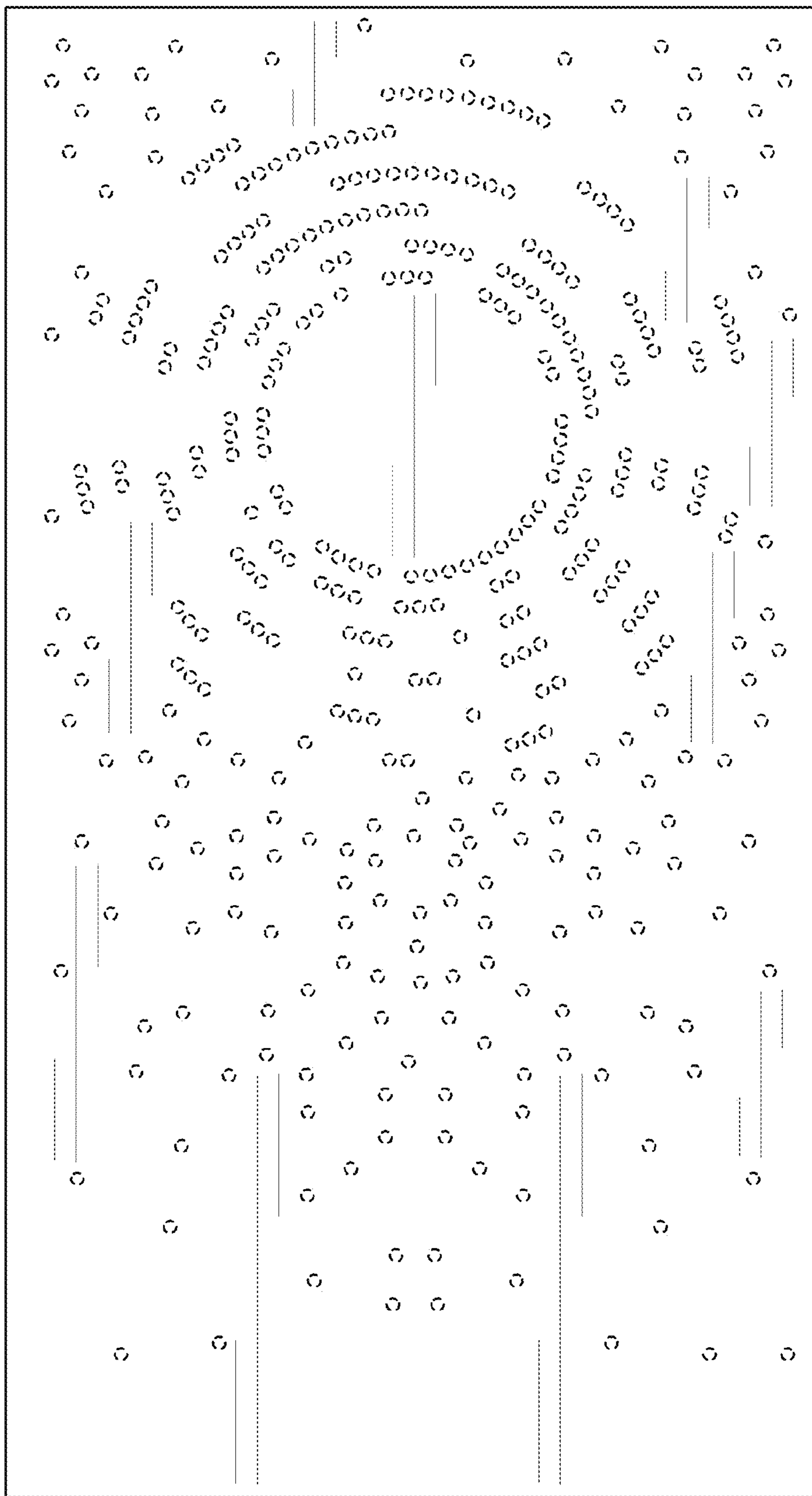

FIG. 2

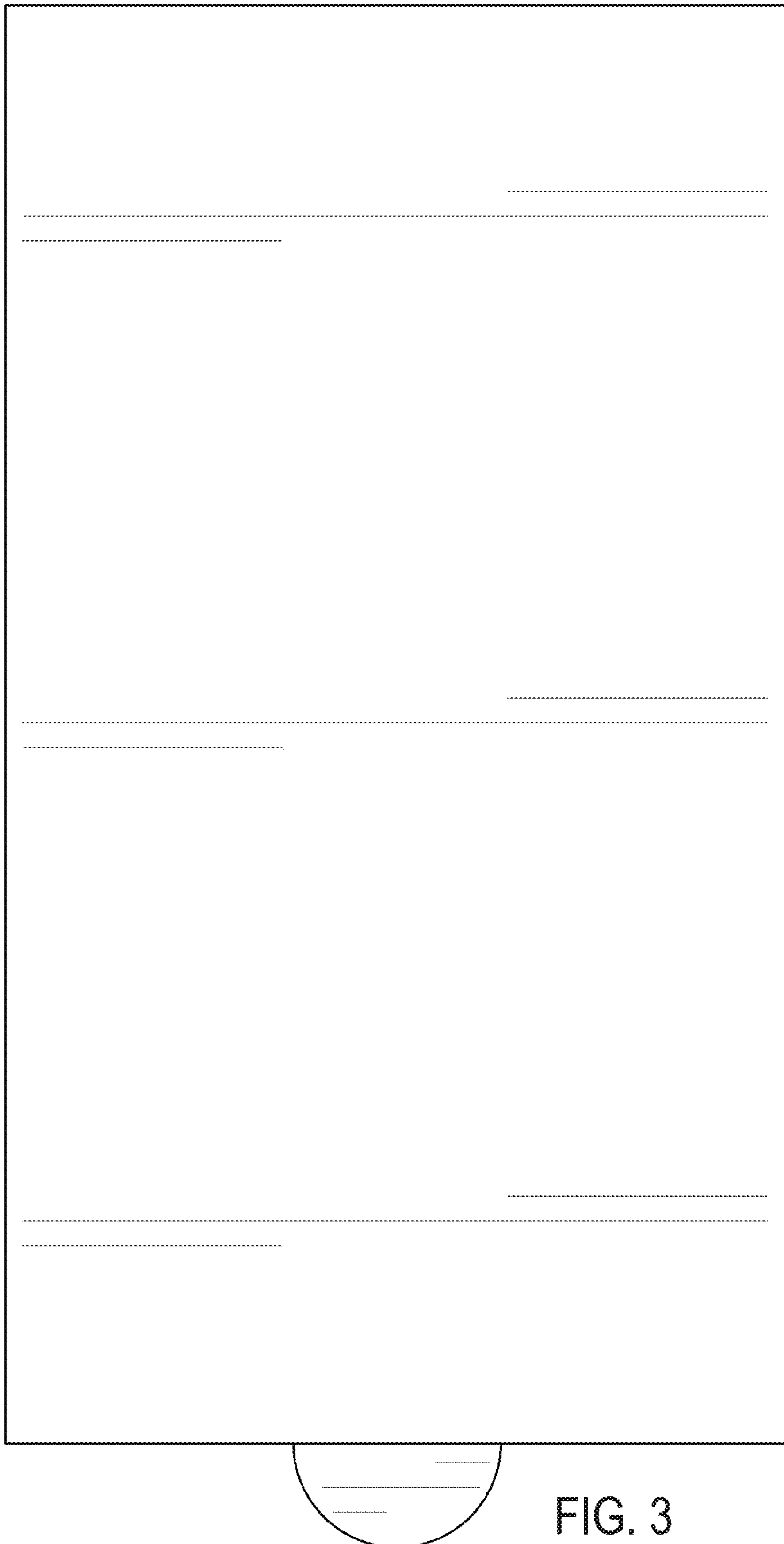

FIG. 3

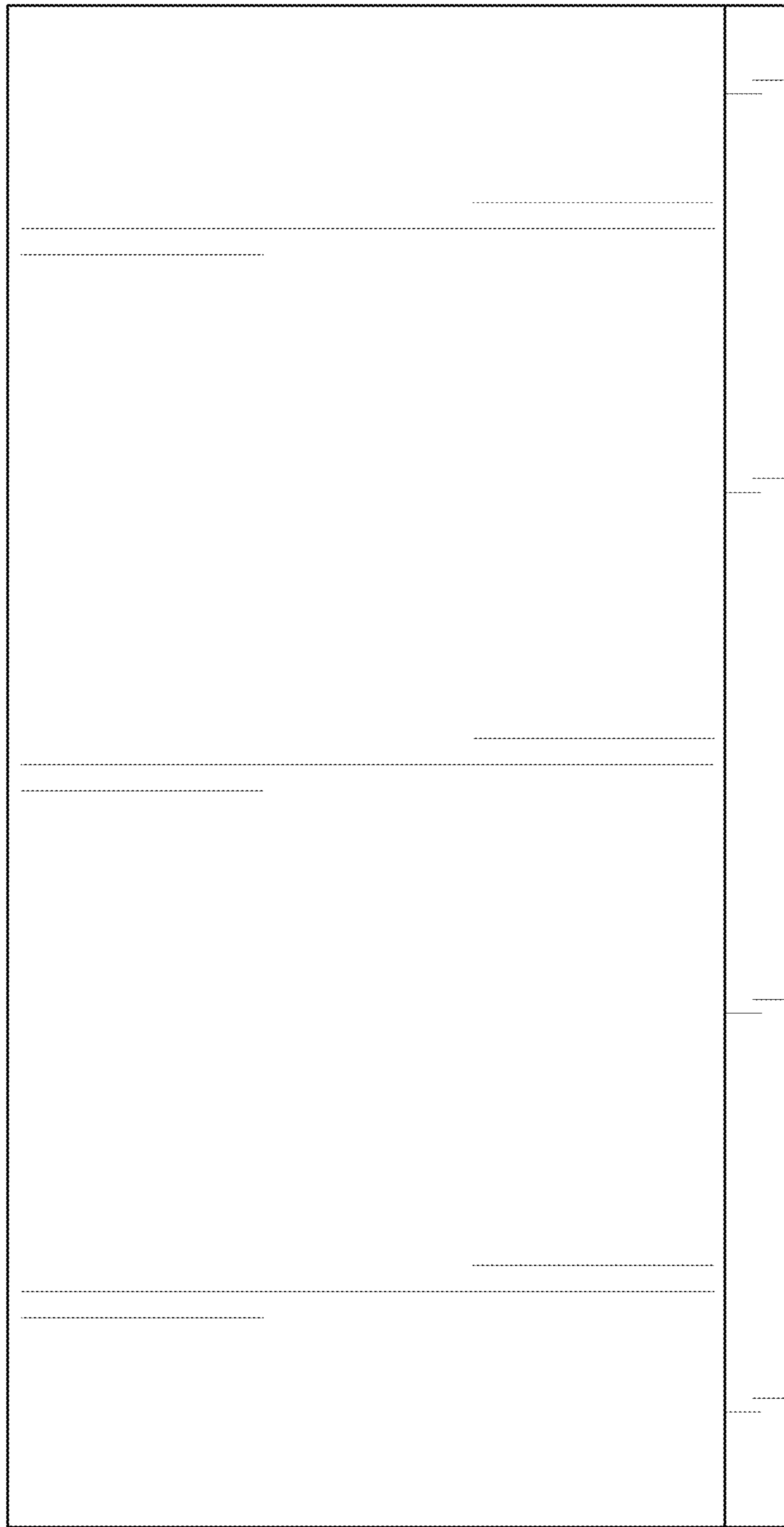

FIG. 4

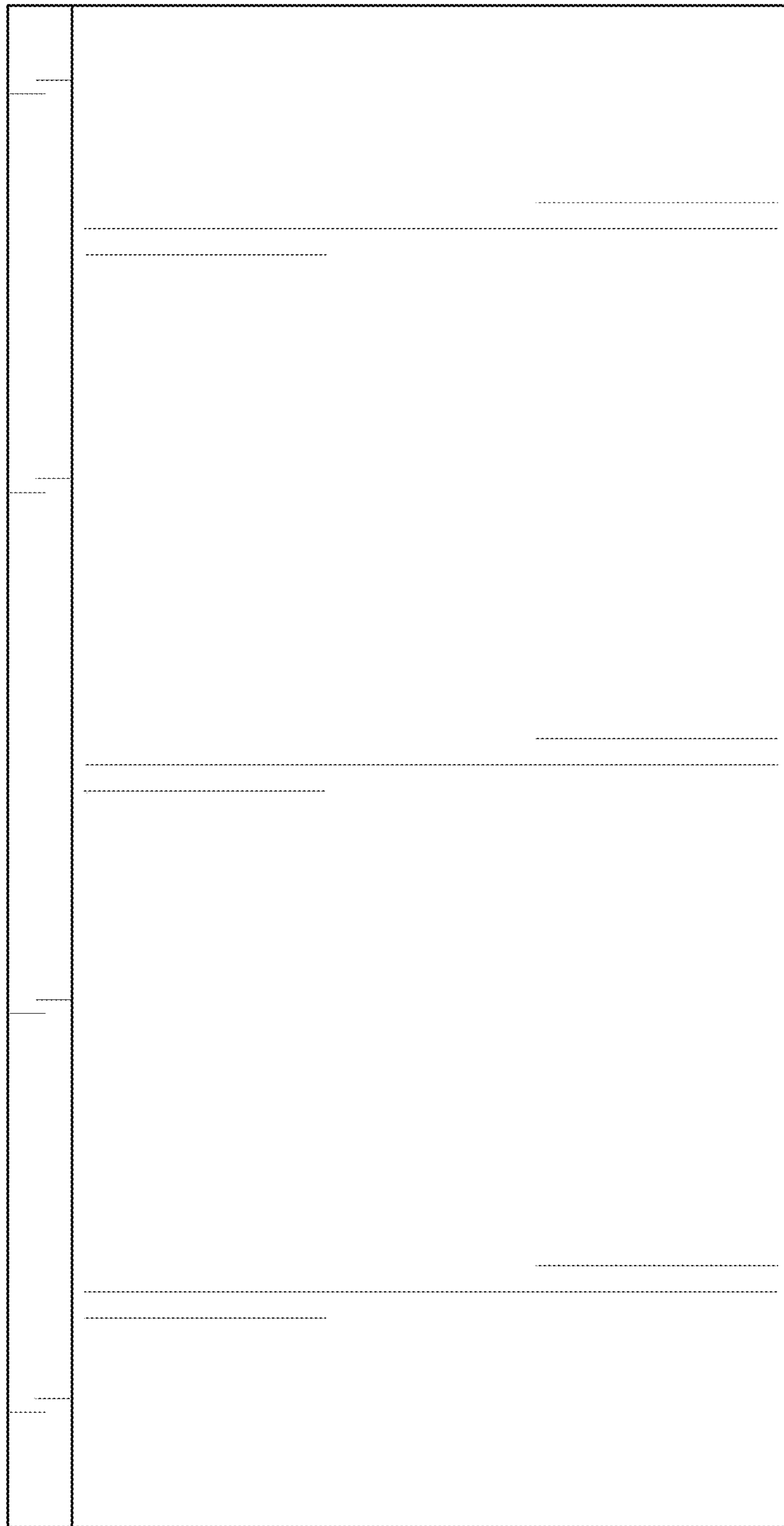

FIG. 5

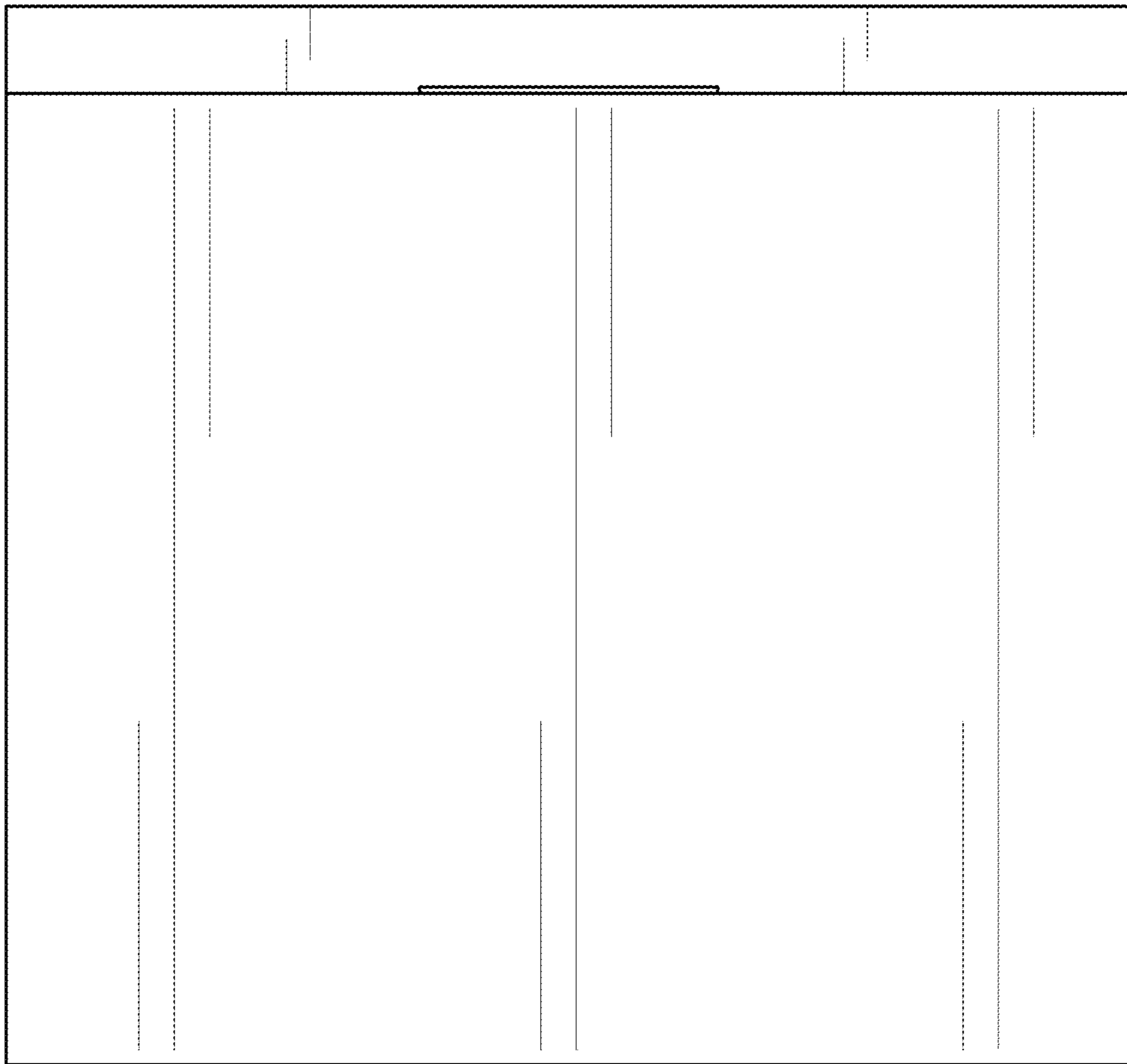

FIG. 6

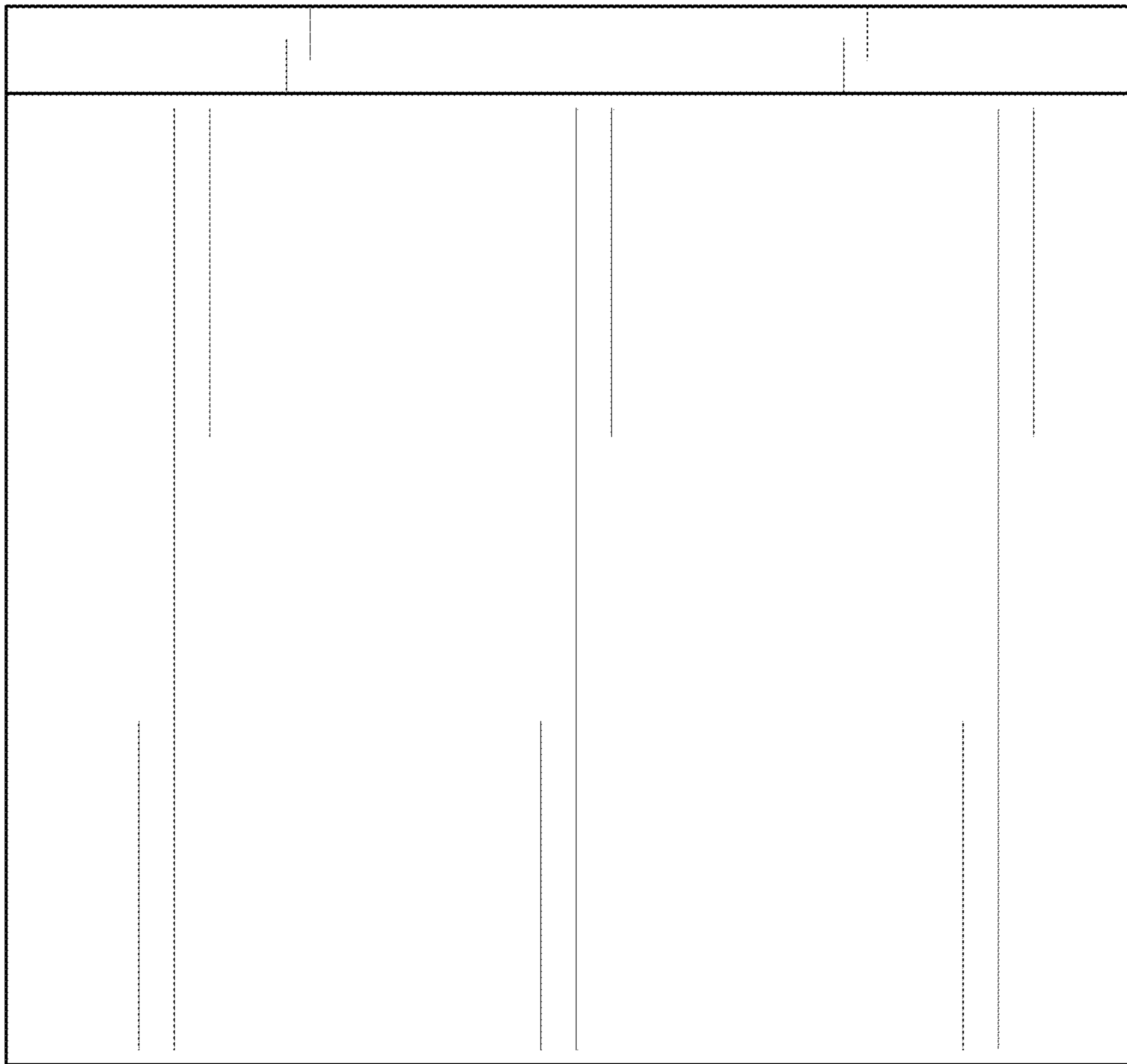

FIG. 7

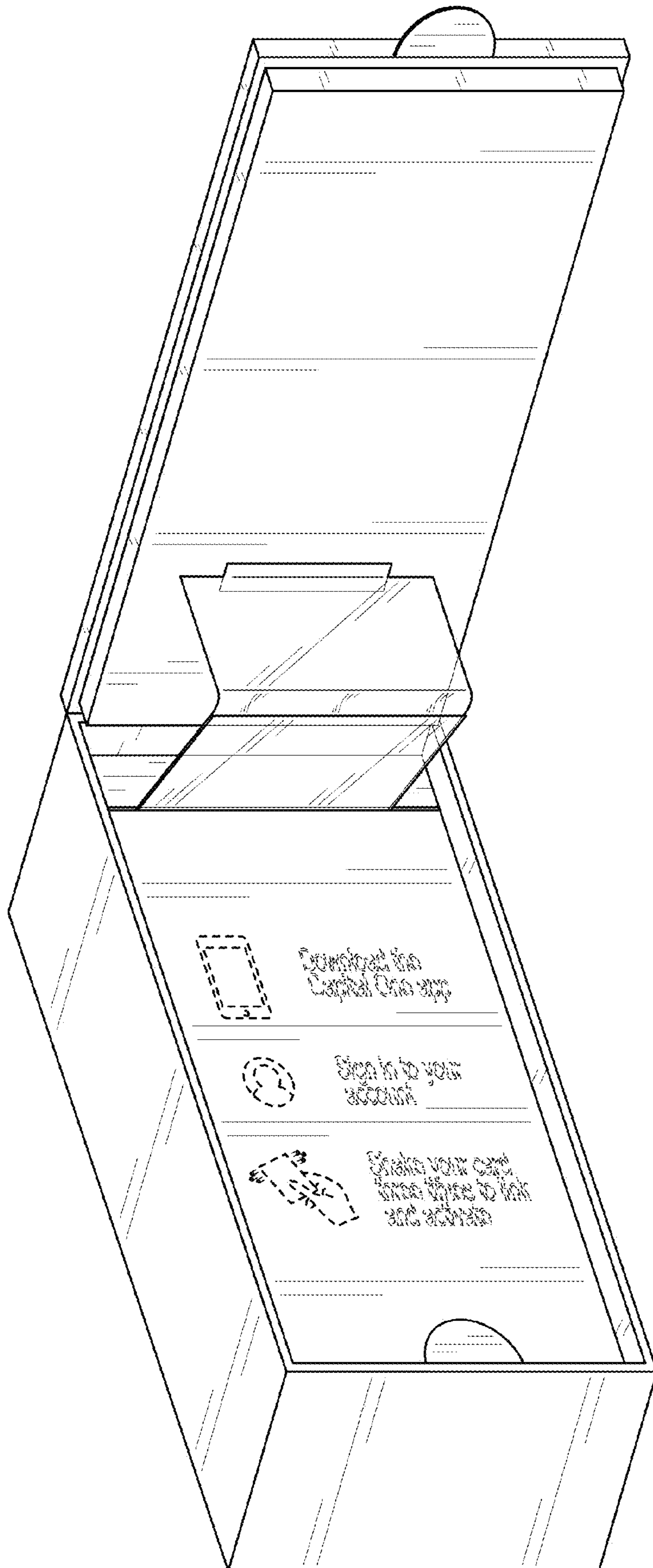

FIG. 8

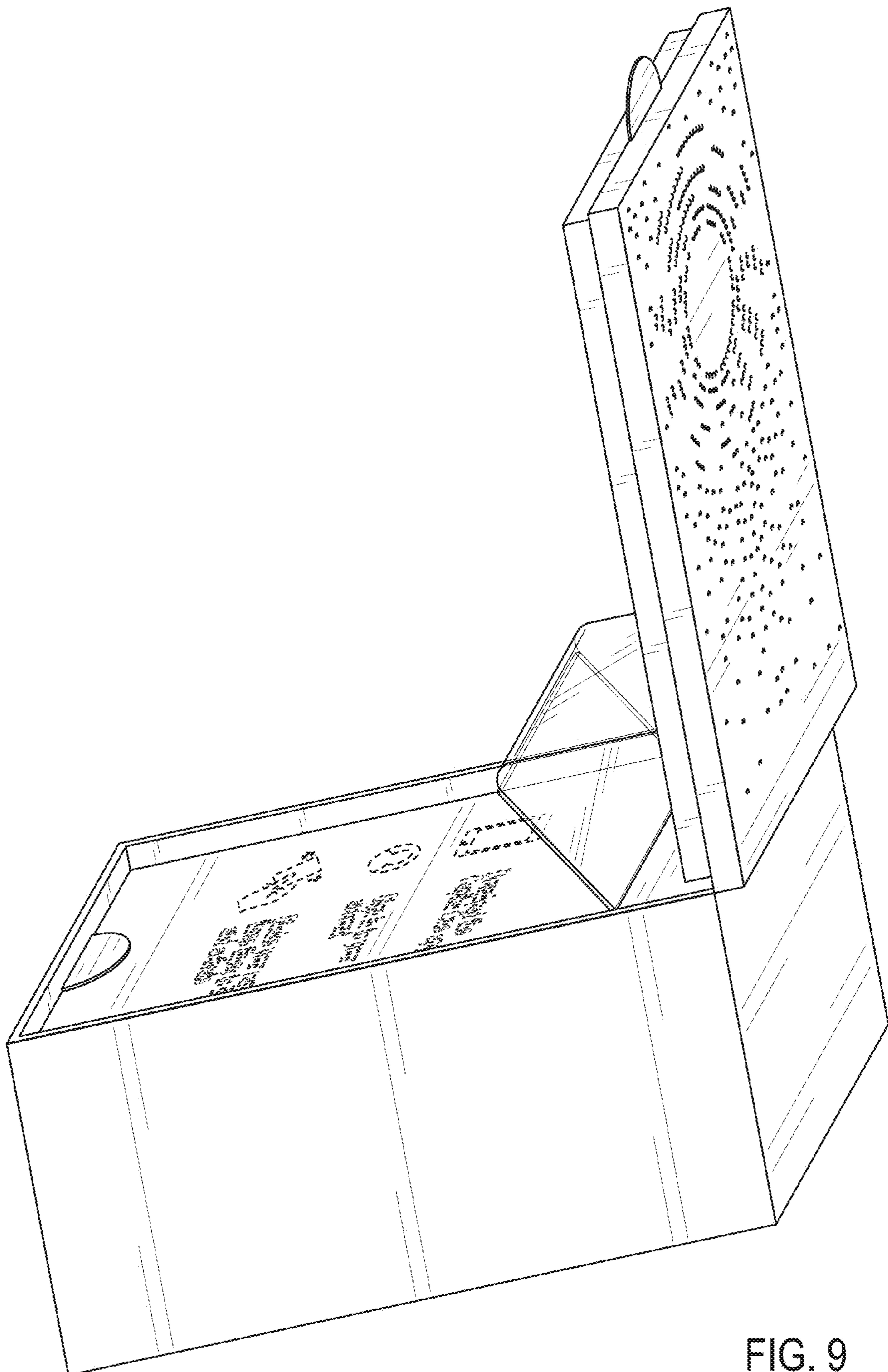

FIG. 9

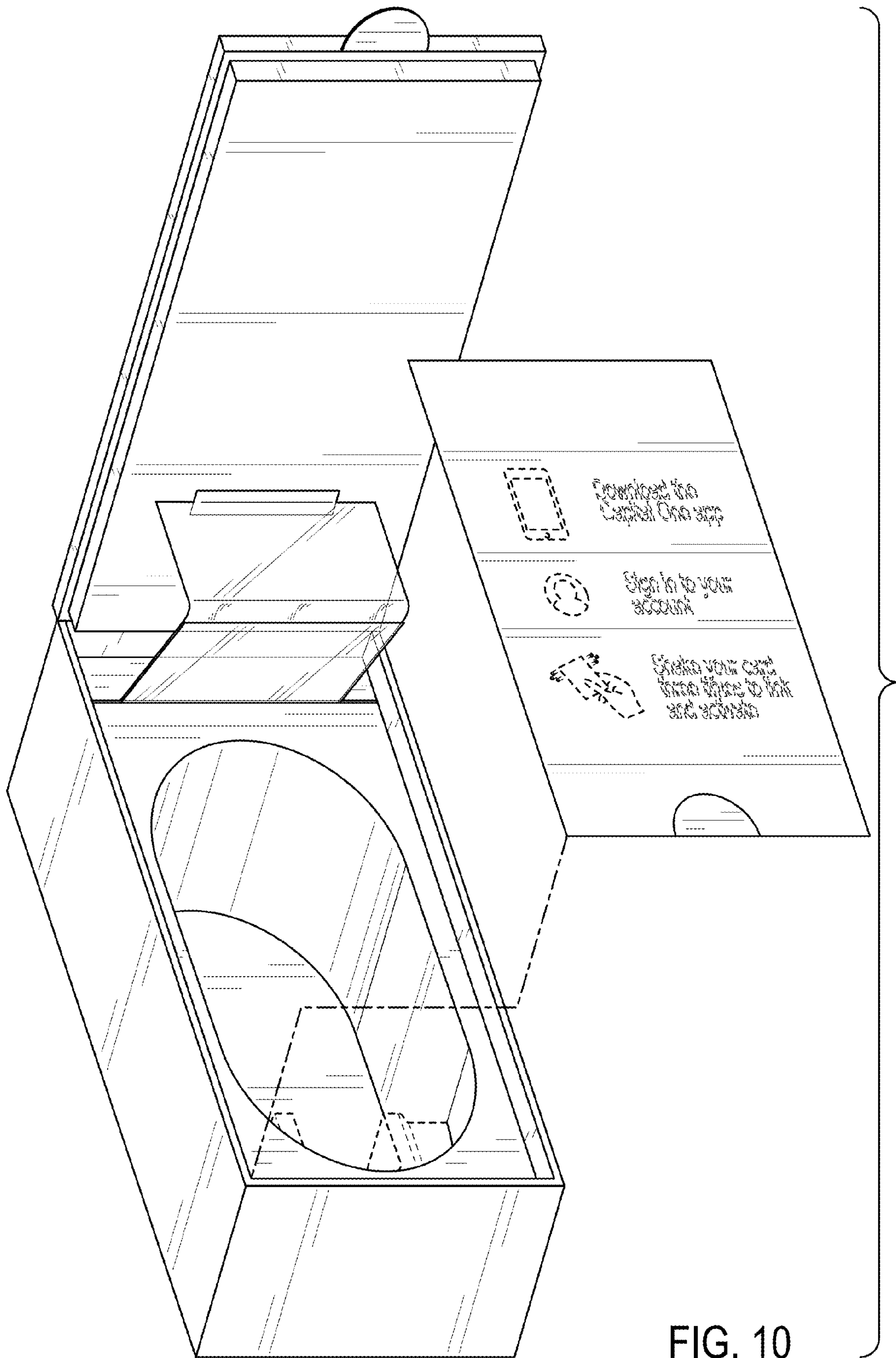

FIG. 10

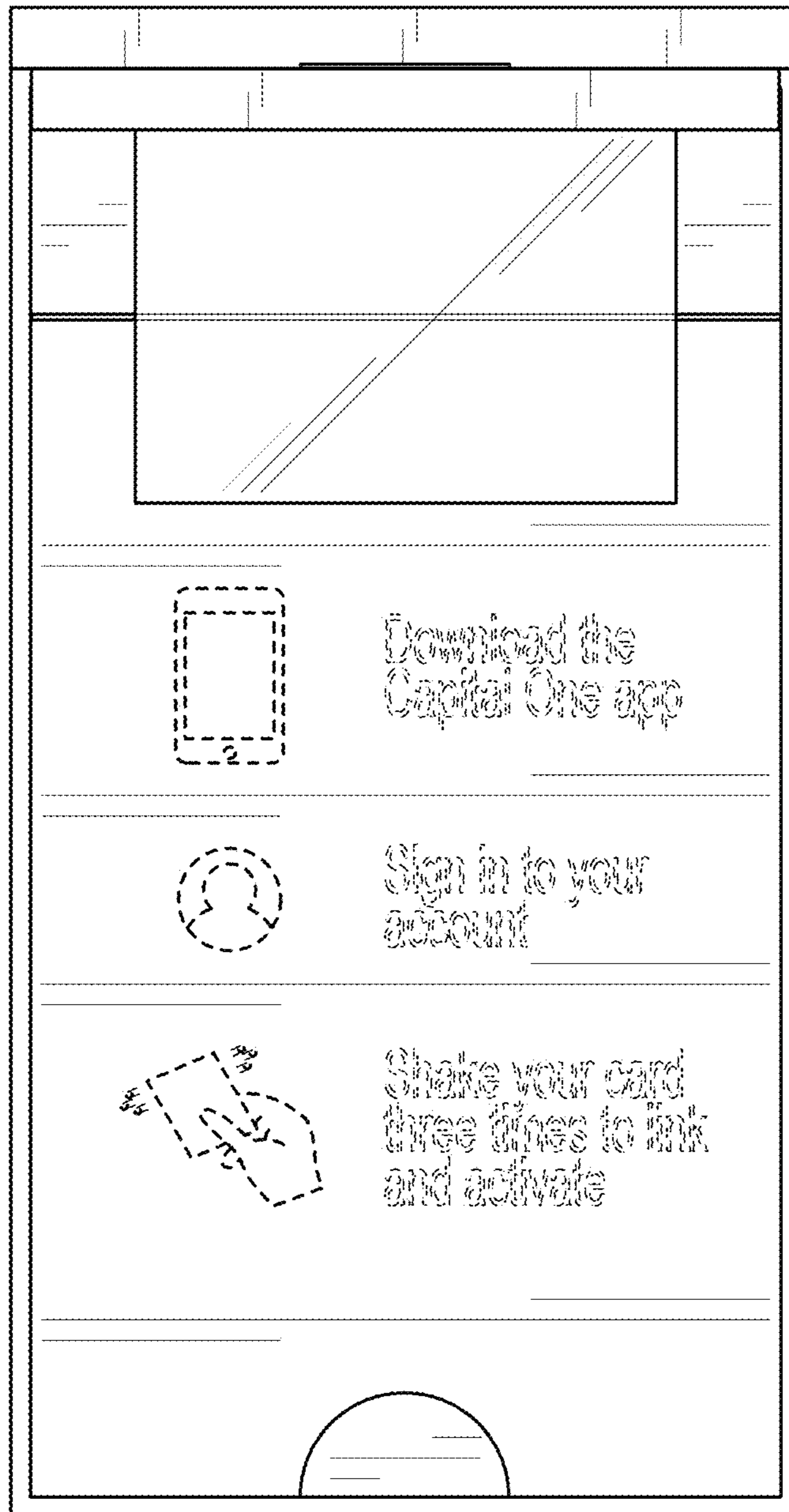

FIG. 11

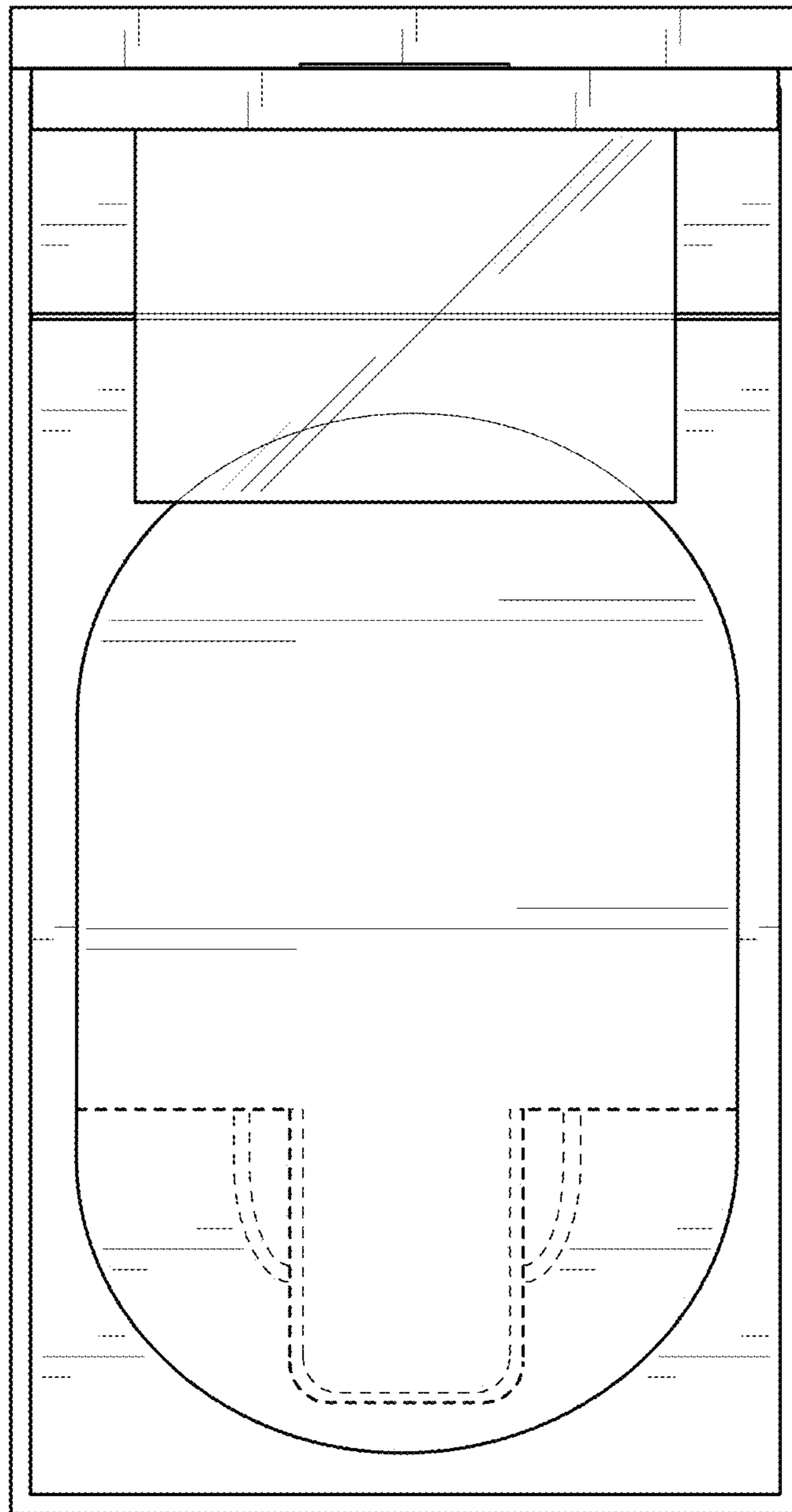

FIG. 12

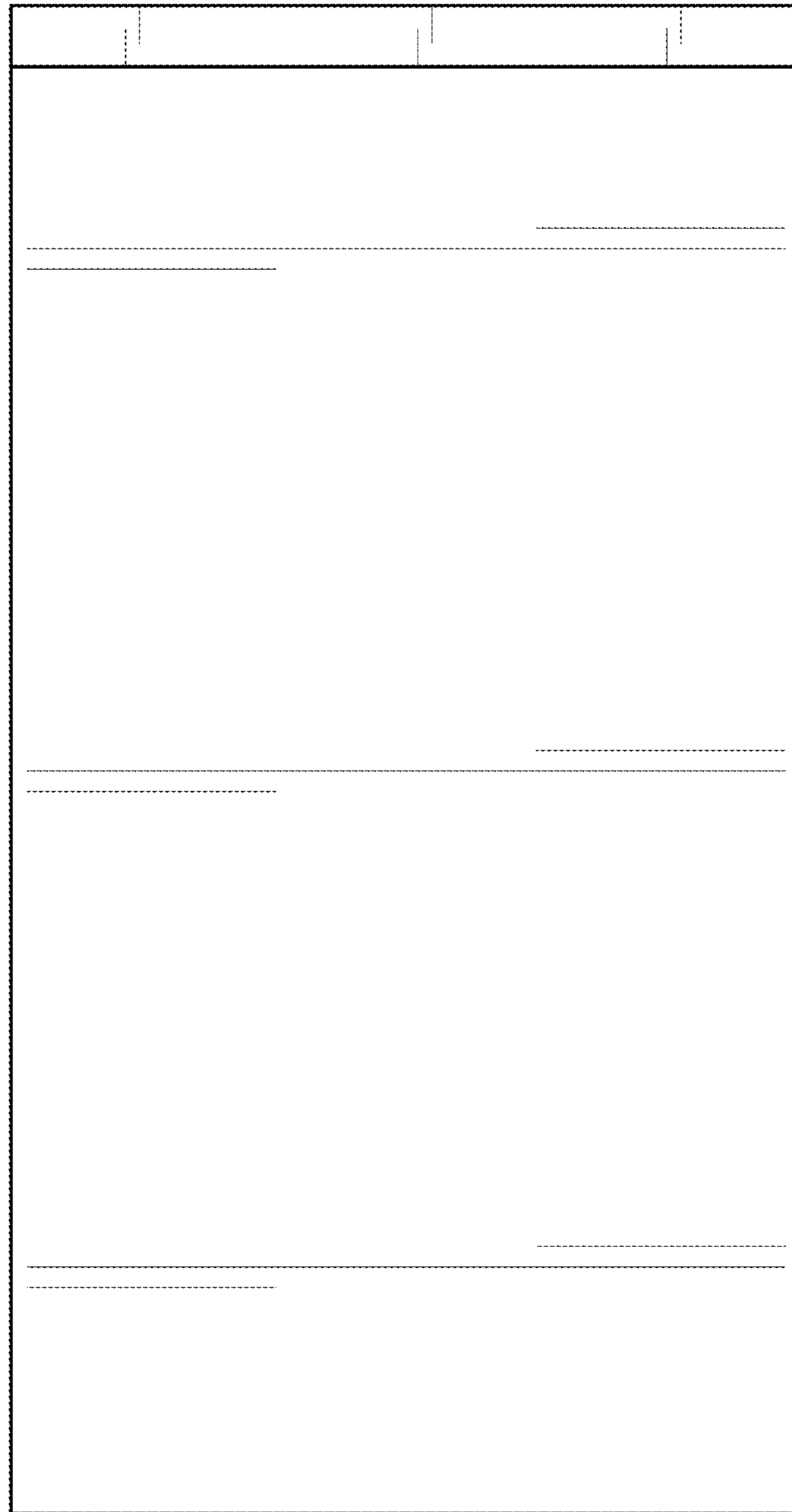

FIG. 13

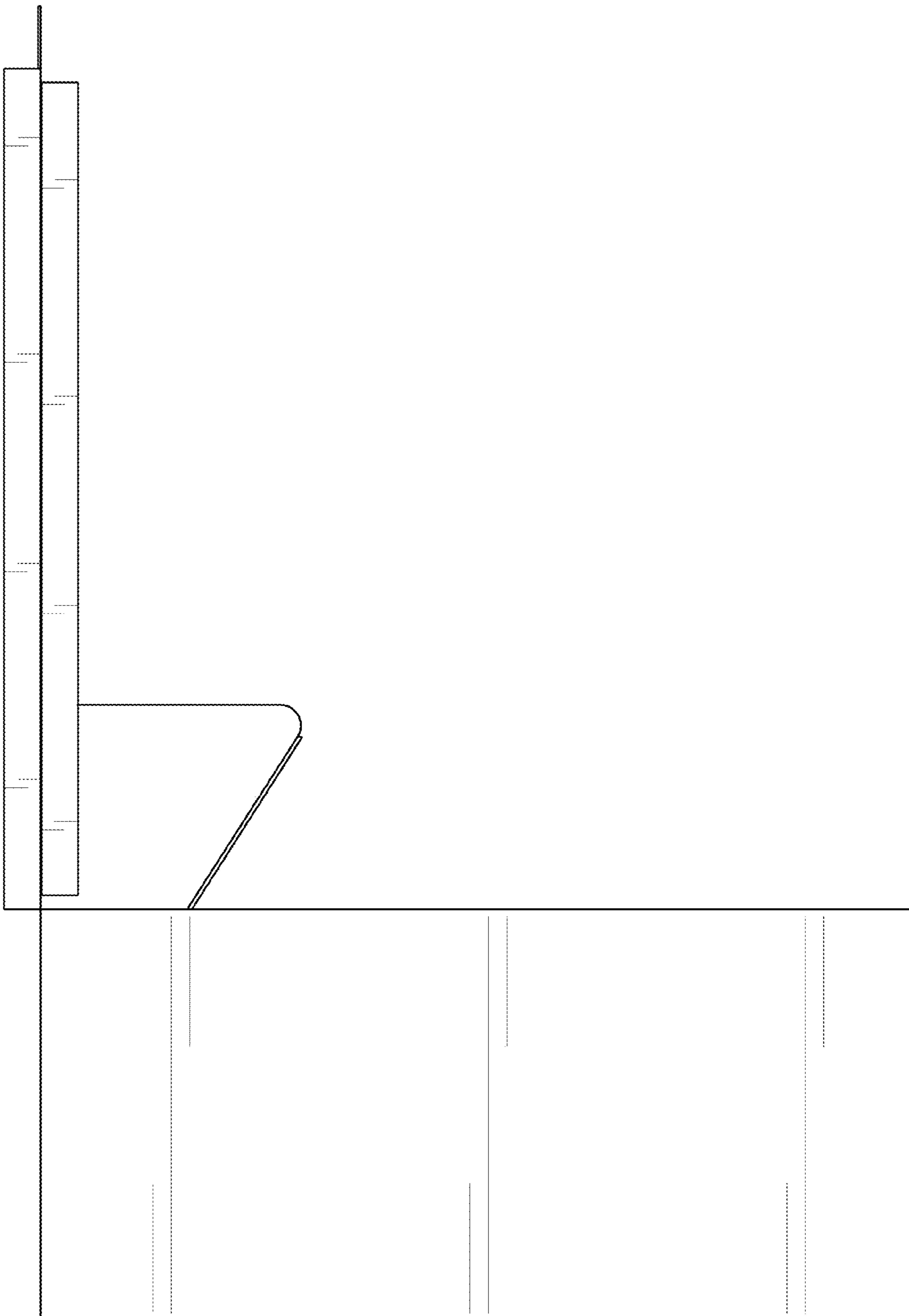

FIG. 14

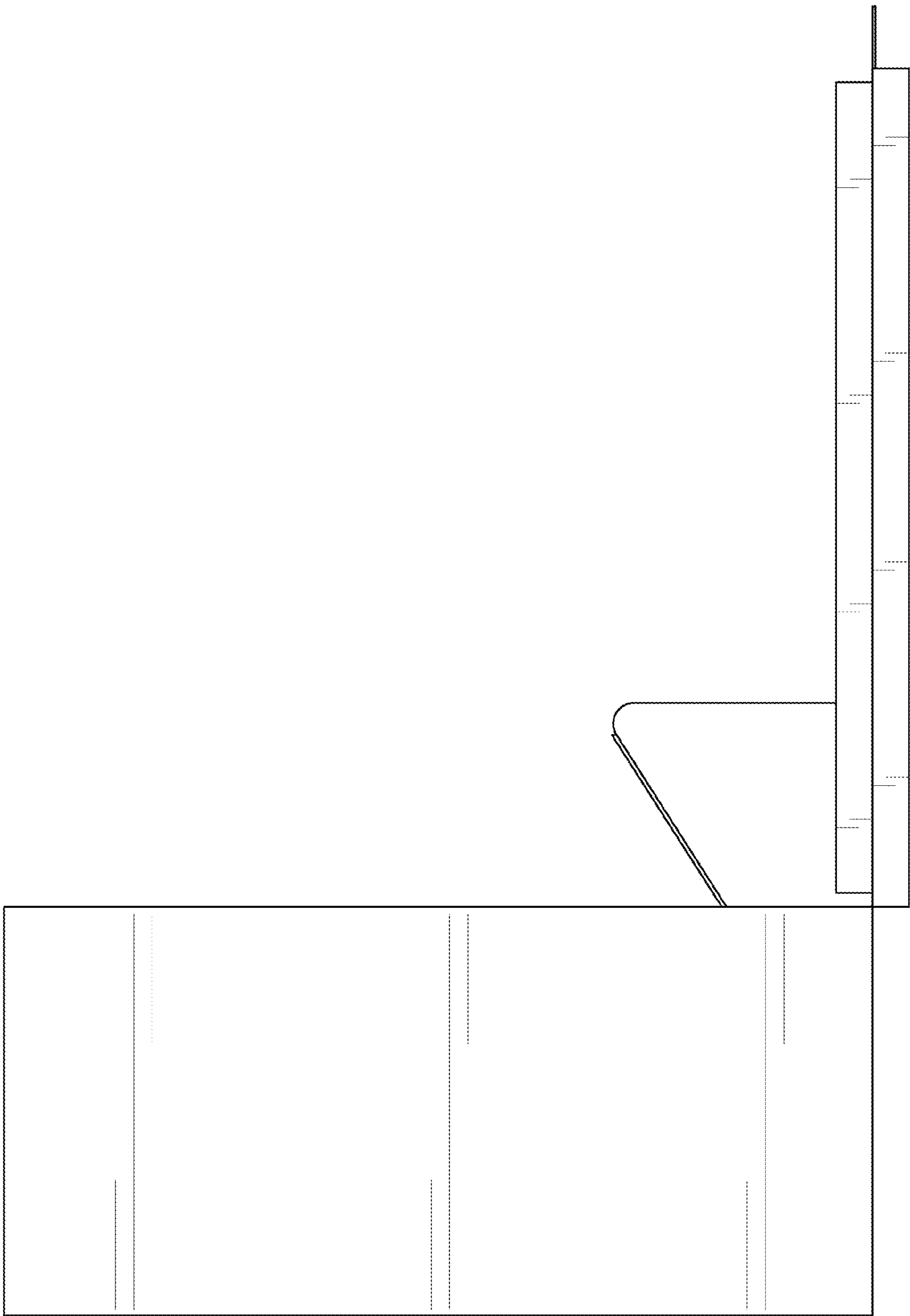

FIG. 15

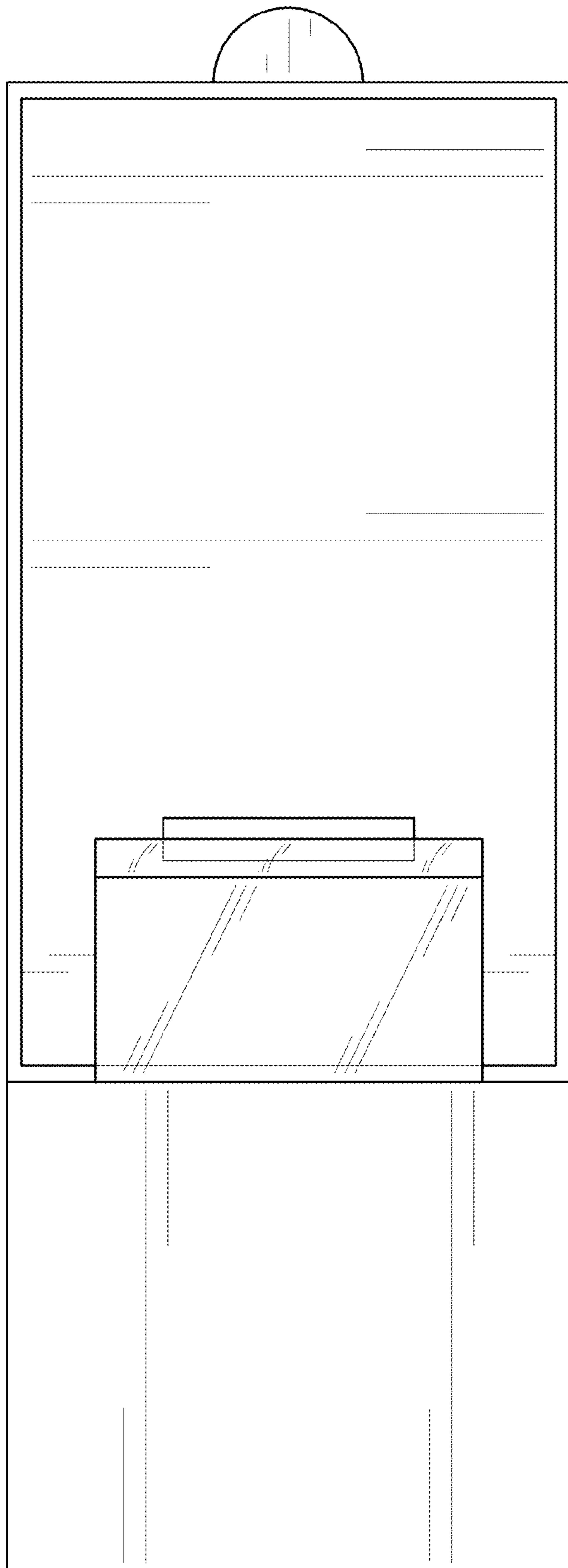

FIG. 16

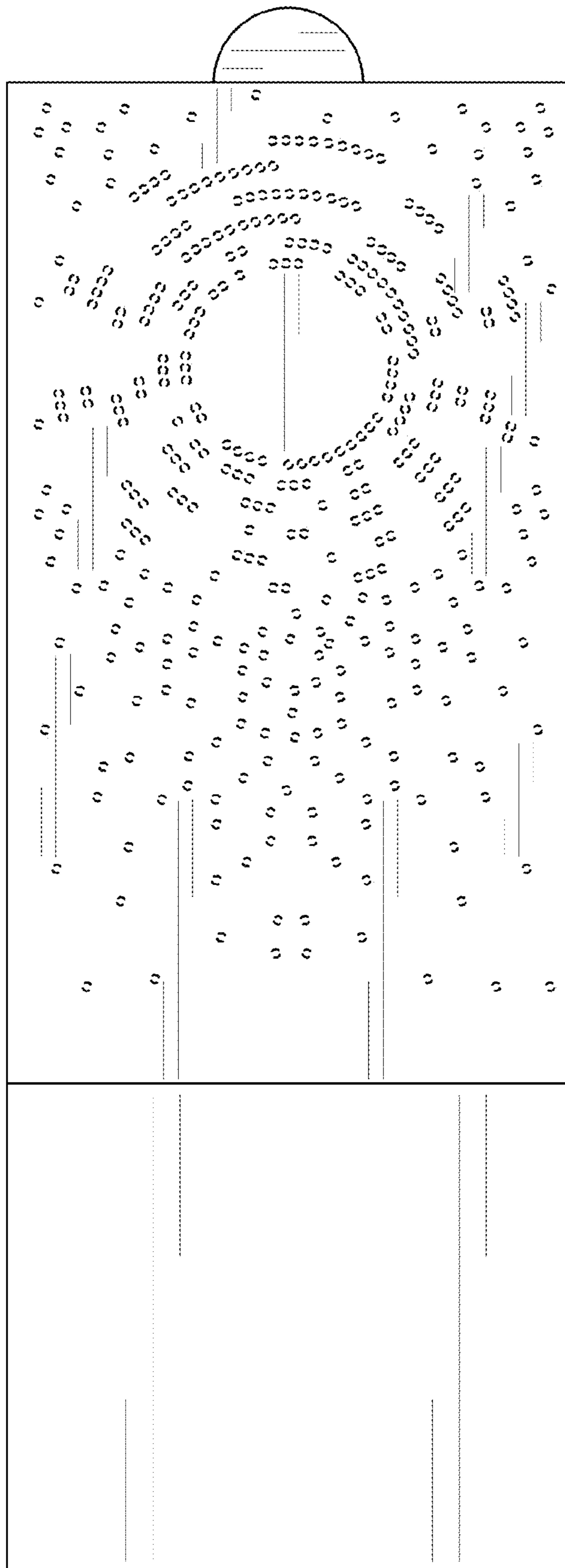

FIG. 17

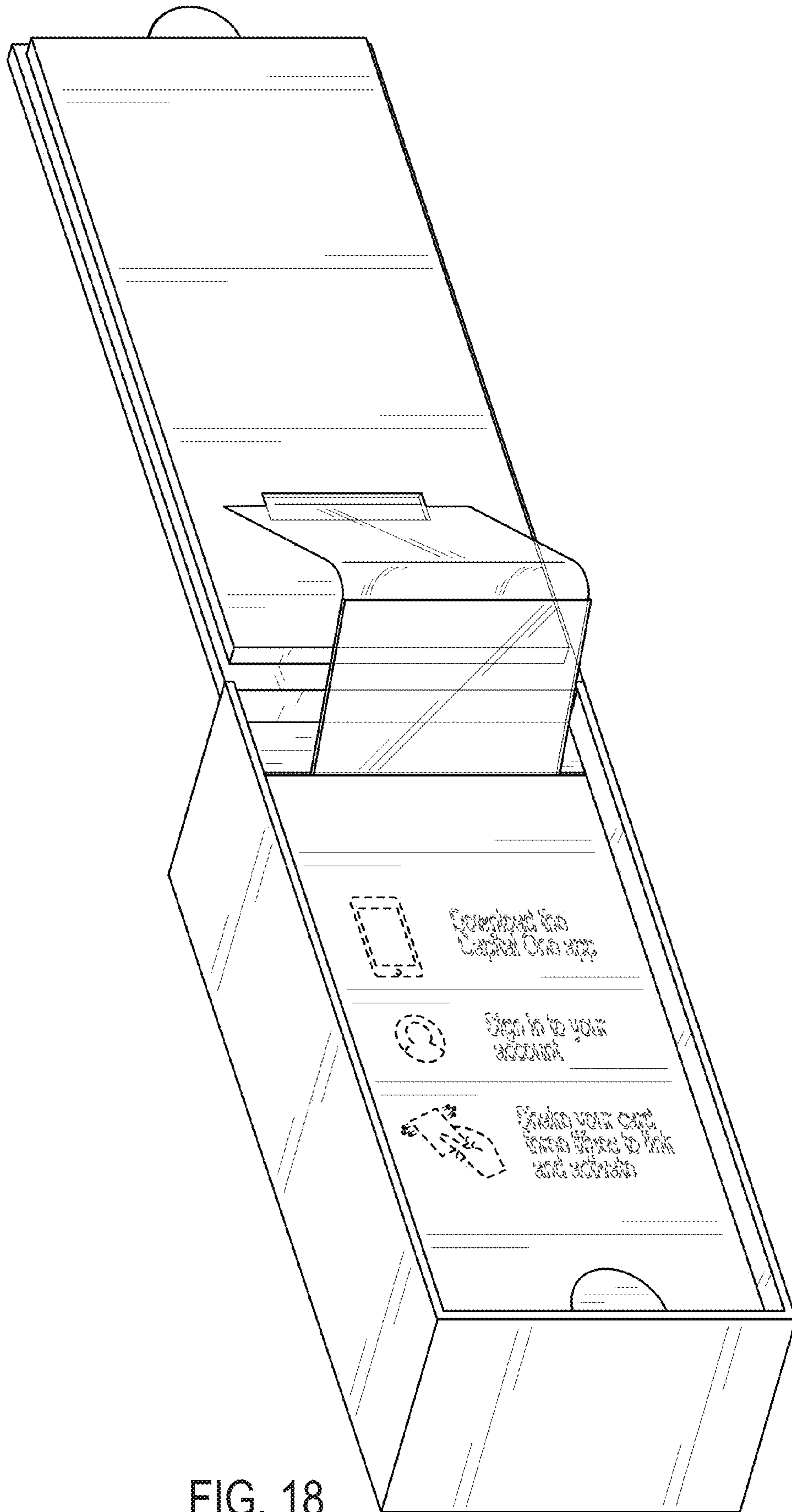

FIG. 18

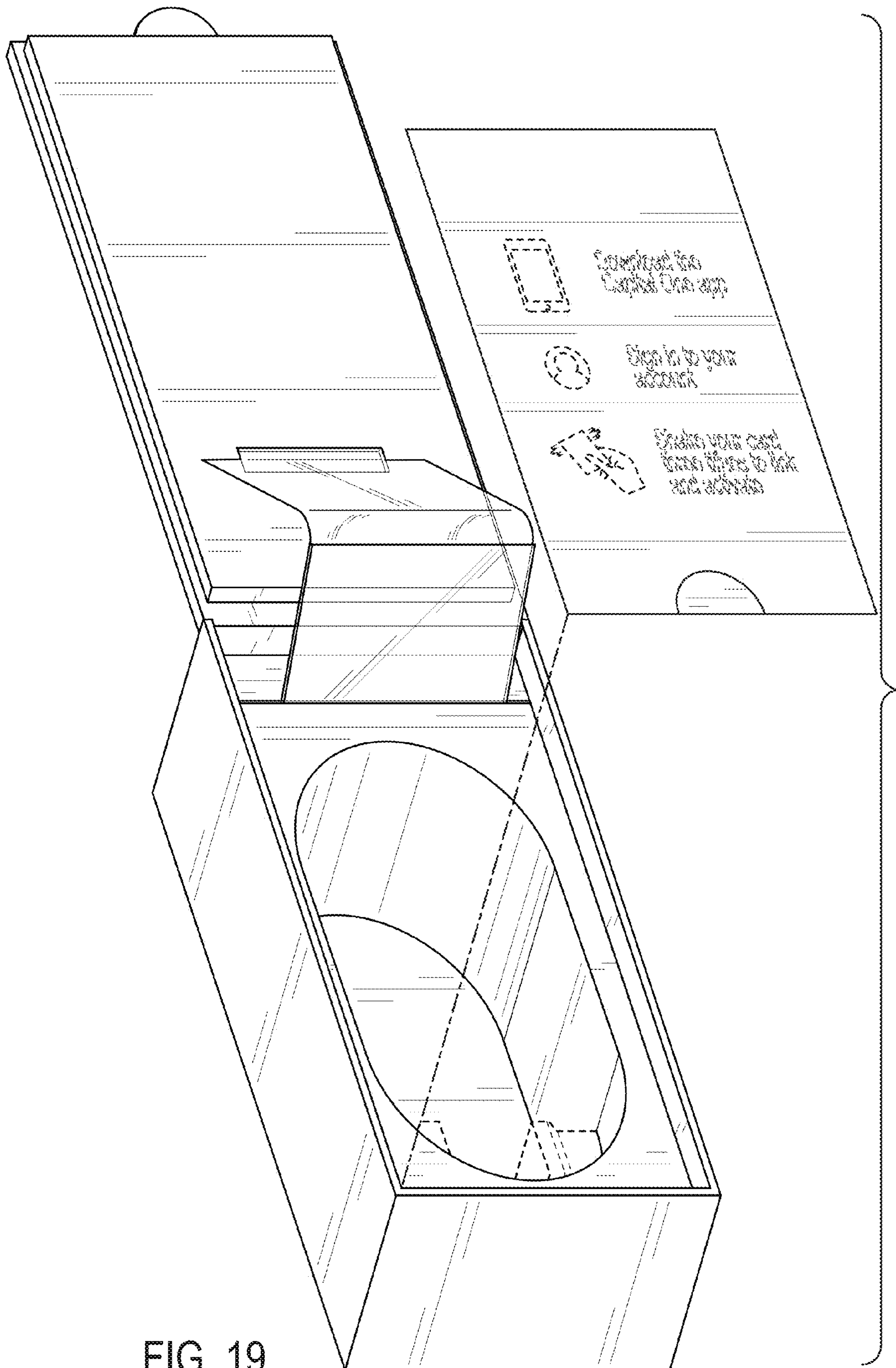

FIG. 19

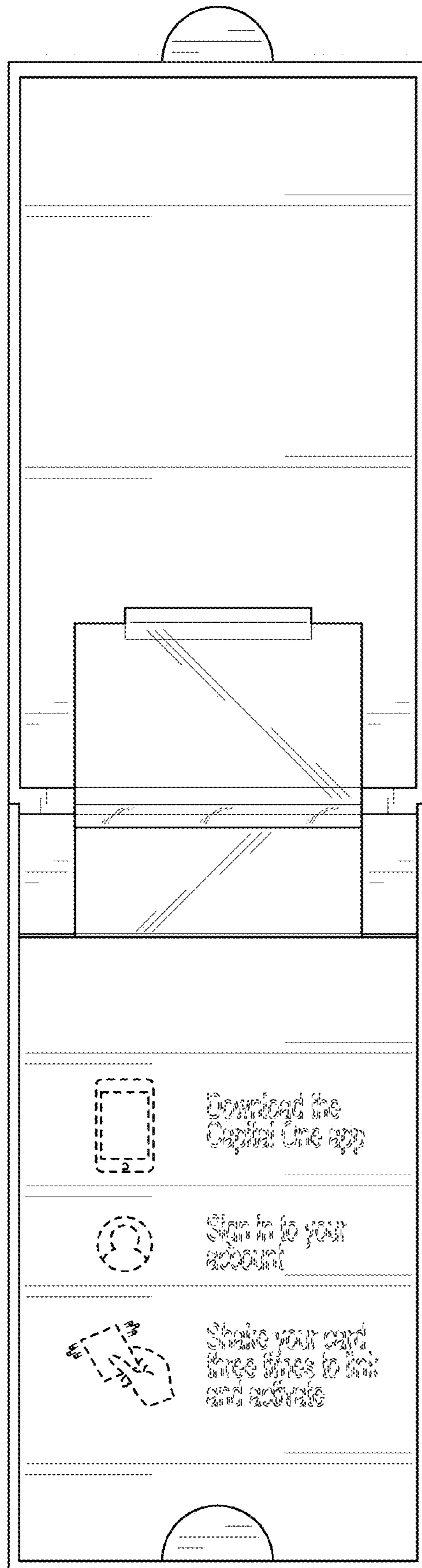

FIG. 20

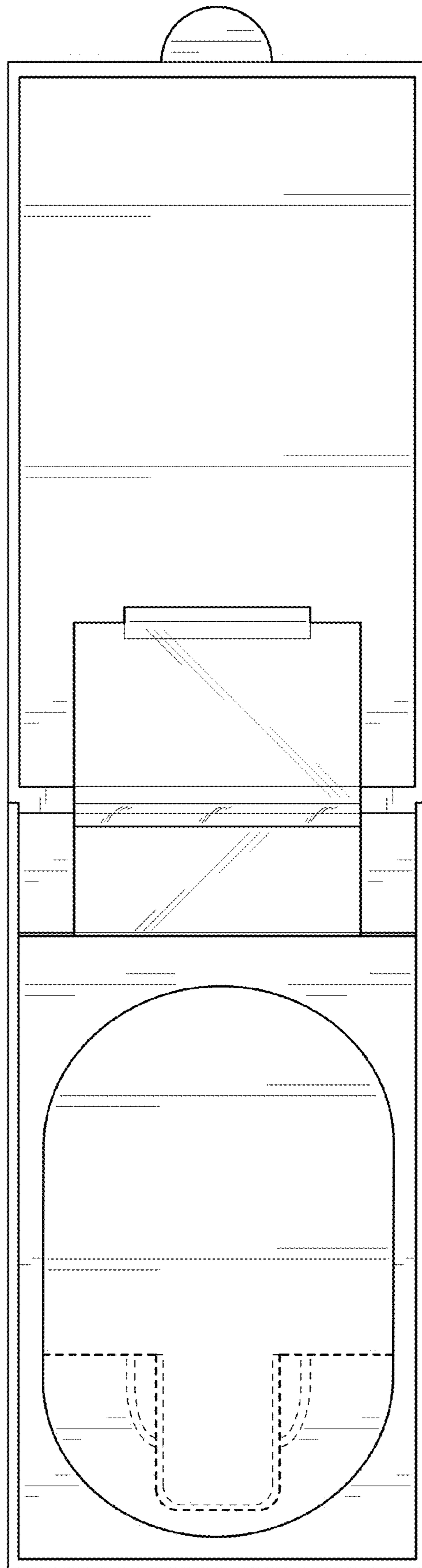

FIG. 21

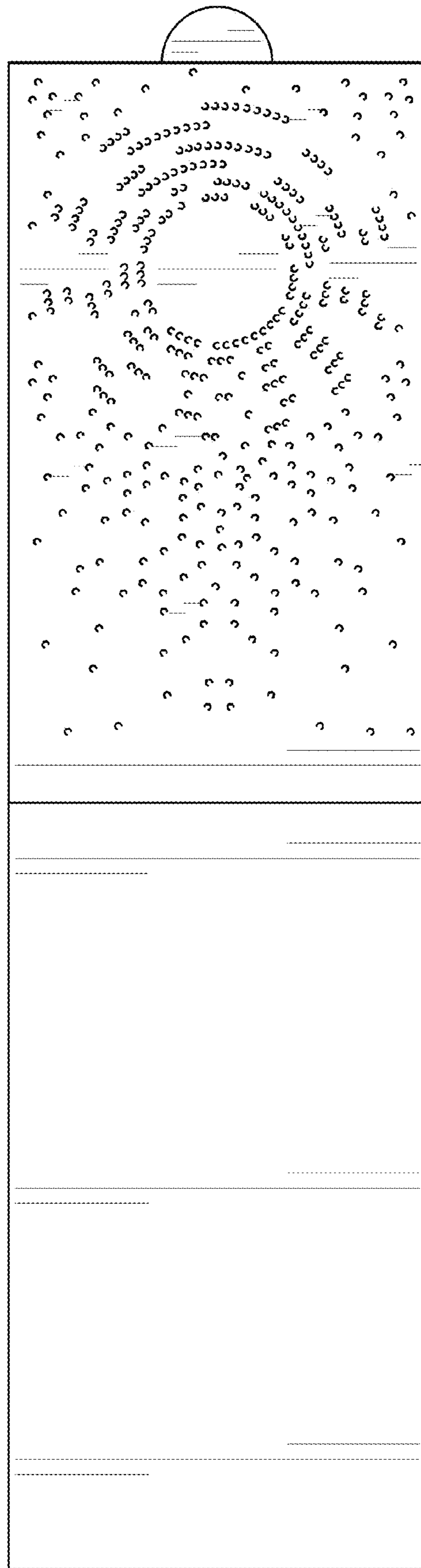

FIG. 22

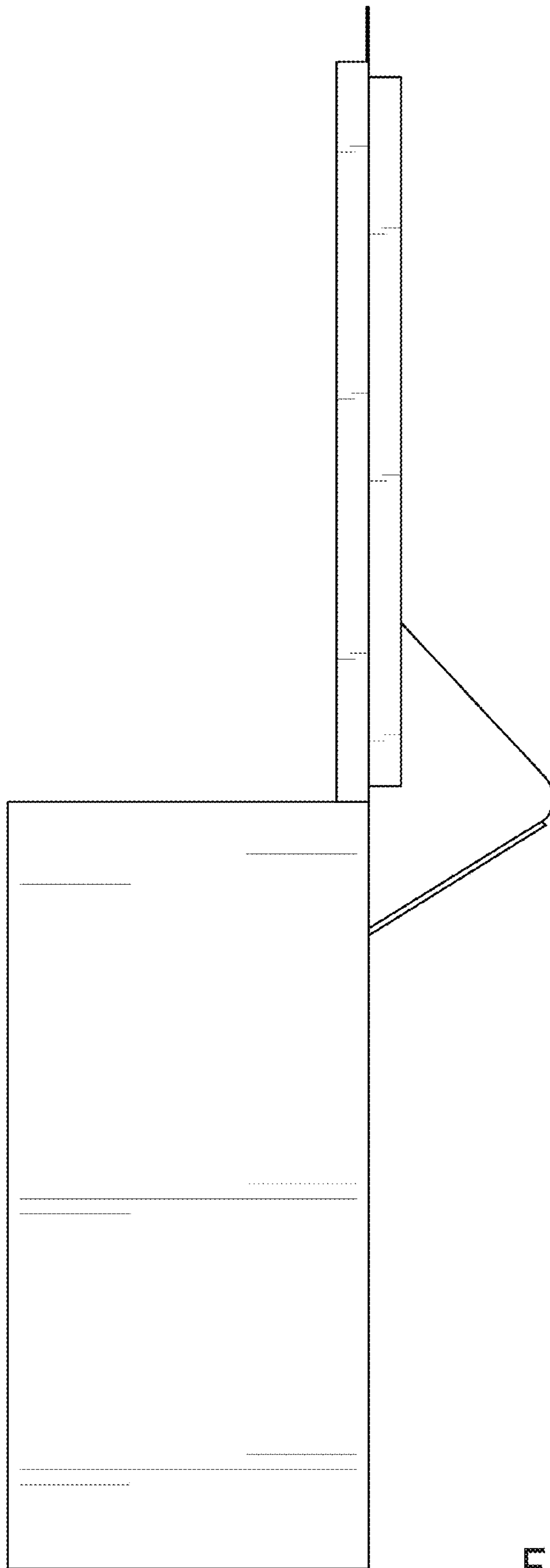

FIG. 23

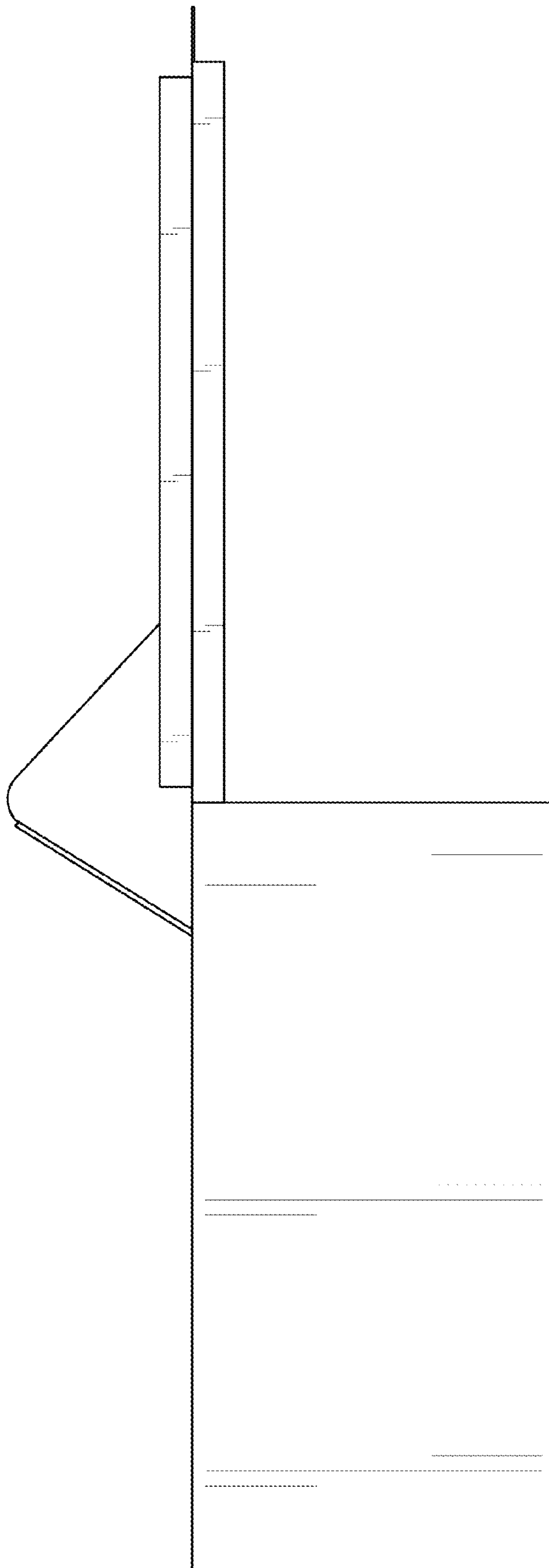

FIG. 24

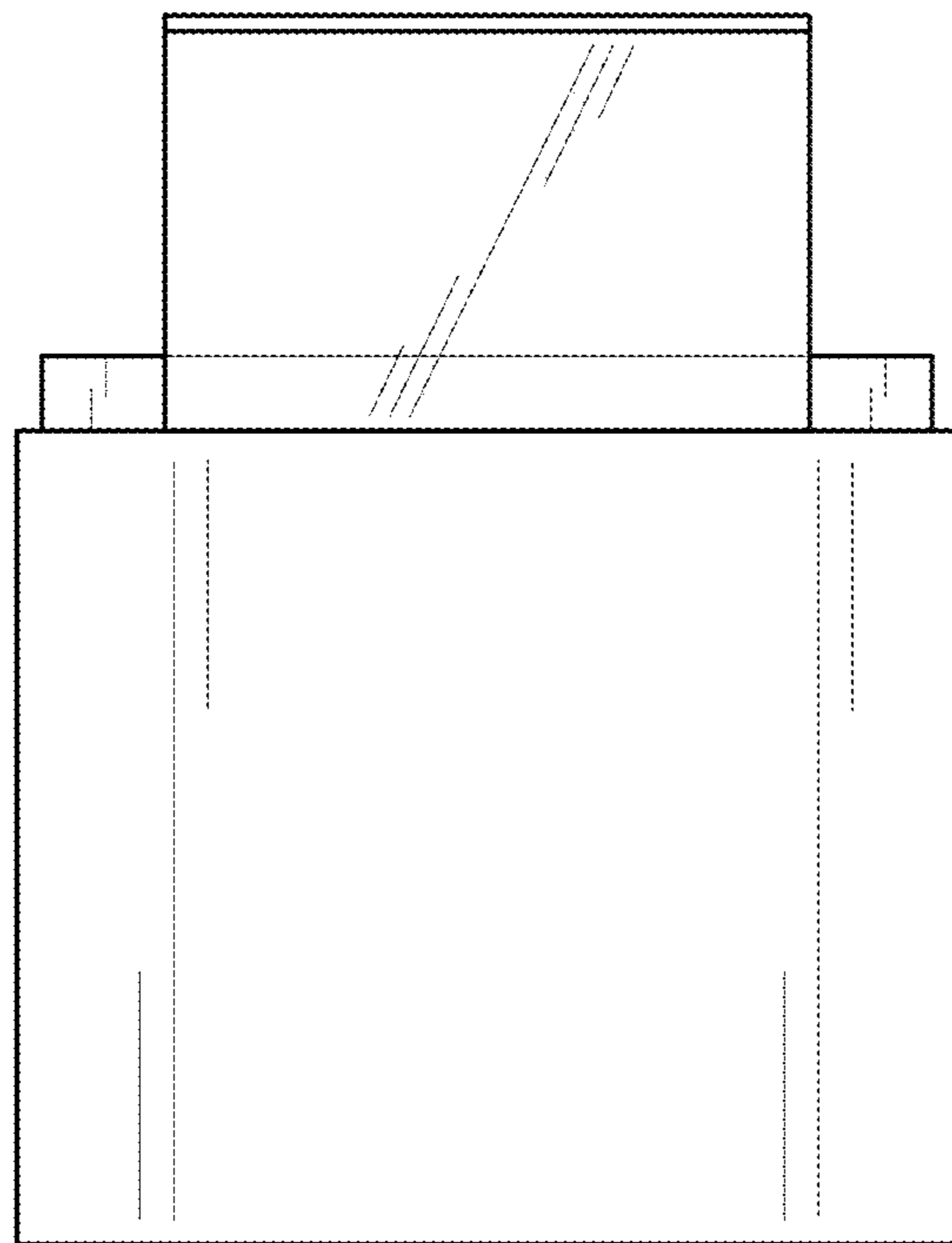

FIG. 25

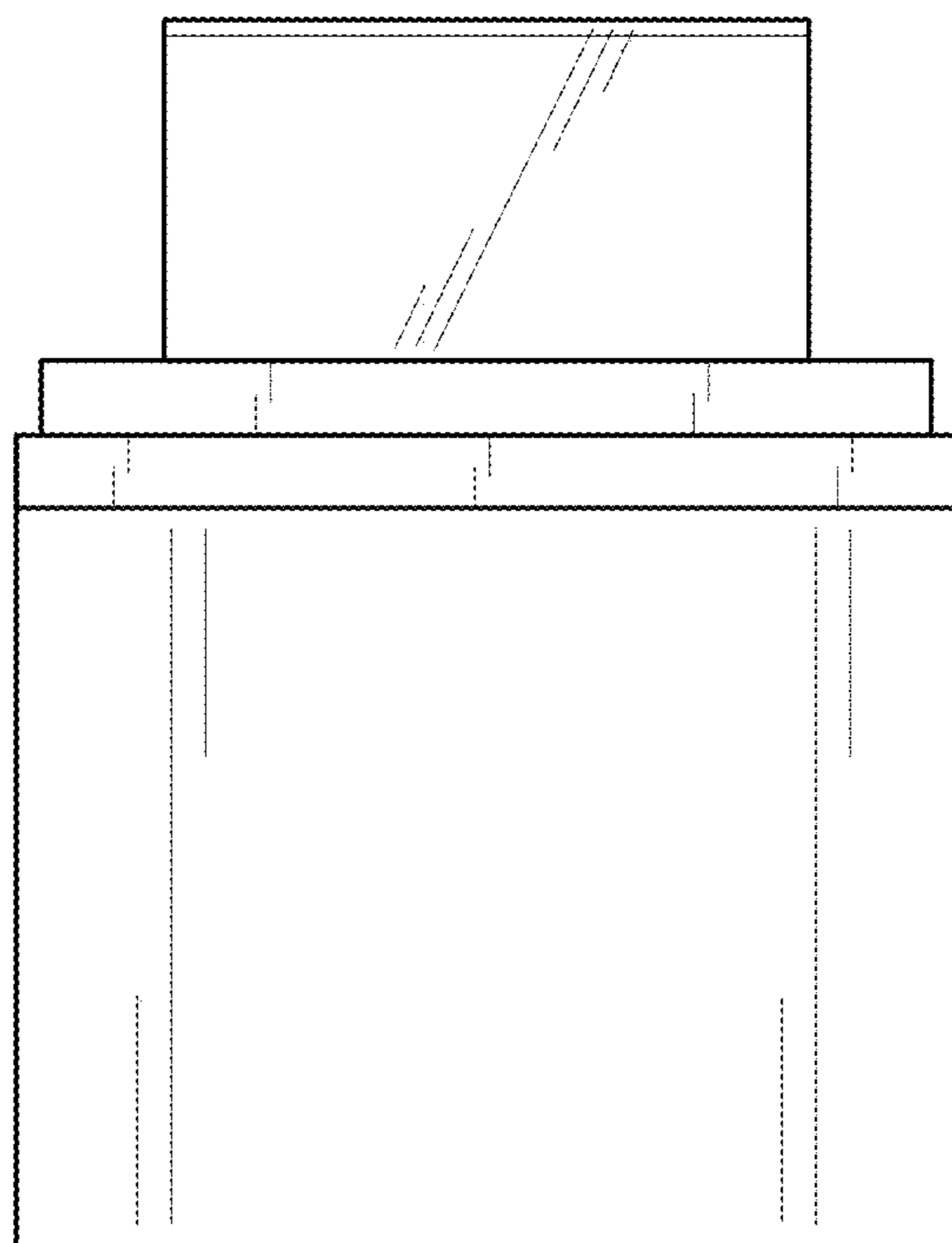

FIG. 26