



US00D871127S

(12) **United States Design Patent**
Lv

(10) **Patent No.:** **US D871,127 S**

(45) **Date of Patent:** **** Dec. 31, 2019**

(54) **CAKE MOLD**

37/00; A47J 37/04; B65D 1/22; B65D
1/24; B65D 1/34; B65D 1/36; B65D
81/343; B65D 85/36

(71) Applicant: **ZHEJIANG MARISSA INDUSTRY
& TRADE CO., LTD**, Changshan
(CN)

See application file for complete search history.

(72) Inventor: **Yibin Lv**, Changshan (CN)

(56) **References Cited**

(73) Assignee: **ZHEJIANG MARISSA & TRADE
CO., LTD**, Changshan (CN)

U.S. PATENT DOCUMENTS

(**) Term: **15 Years**

D261,285 S * 10/1981 Clark D21/406
D526,838 S * 8/2006 Park D7/359
D530,563 S * 10/2006 Henry D7/359
D578,339 S * 10/2008 Courington D7/359
D604,569 S * 11/2009 Frank D7/689

(21) Appl. No.: **29/665,040**

* cited by examiner

(22) Filed: **Sep. 29, 2018**

Primary Examiner — Ricky Pham

(30) **Foreign Application Priority Data**

(74) *Attorney, Agent, or Firm* — Gokalp Bayramoglu

Aug. 14, 2018 (CN) 2018 3 0447218

(51) **LOC (12) Cl.** **07-02**

(52) **U.S. Cl.**

USPC **D7/359**; D7/354; D7/357

(58) **Field of Classification Search**

USPC D1/115; D7/323, 354–361, 392.1, 543,
D7/545, 549, 550.1, 553.1–553.8,
D7/554.1–554.4, 555, 584, 586, 675, 689;
D9/430–433, 455–456, 737, 756–762;
D21/406

CPC A21B 3/00; A21B 3/13; A21B 3/15; A21B
3/134; A21B 5/00; A21B 5/02; A47J
36/022; A47J 36/025; A47J 36/027; A47J

(57) **CLAIM**

The ornamental design for cake mold, as shown and described.

DESCRIPTION

FIG. 1 is a perspective top view of cake mold showing the new design;

FIG. 2 is a front view thereof;

FIG. 3 is a left side view thereof;

FIG. 4 is a rear view thereof;

FIG. 5 is a right side view thereof;

FIG. 6 is a top view thereof;

FIG. 7 is a bottom view thereof; and,

FIG. 8 is a perspective bottom view thereof.

1 Claim, 8 Drawing Sheets

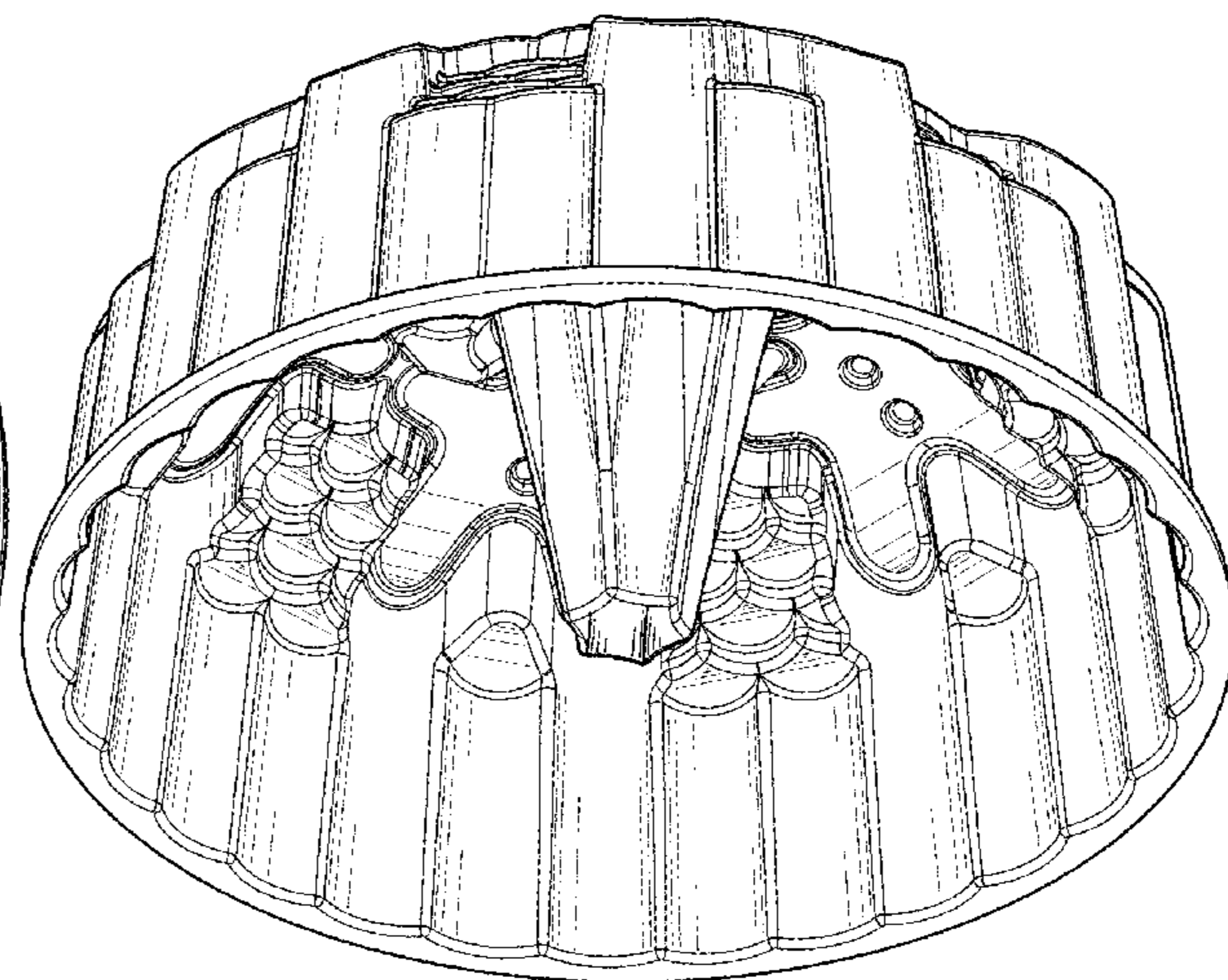
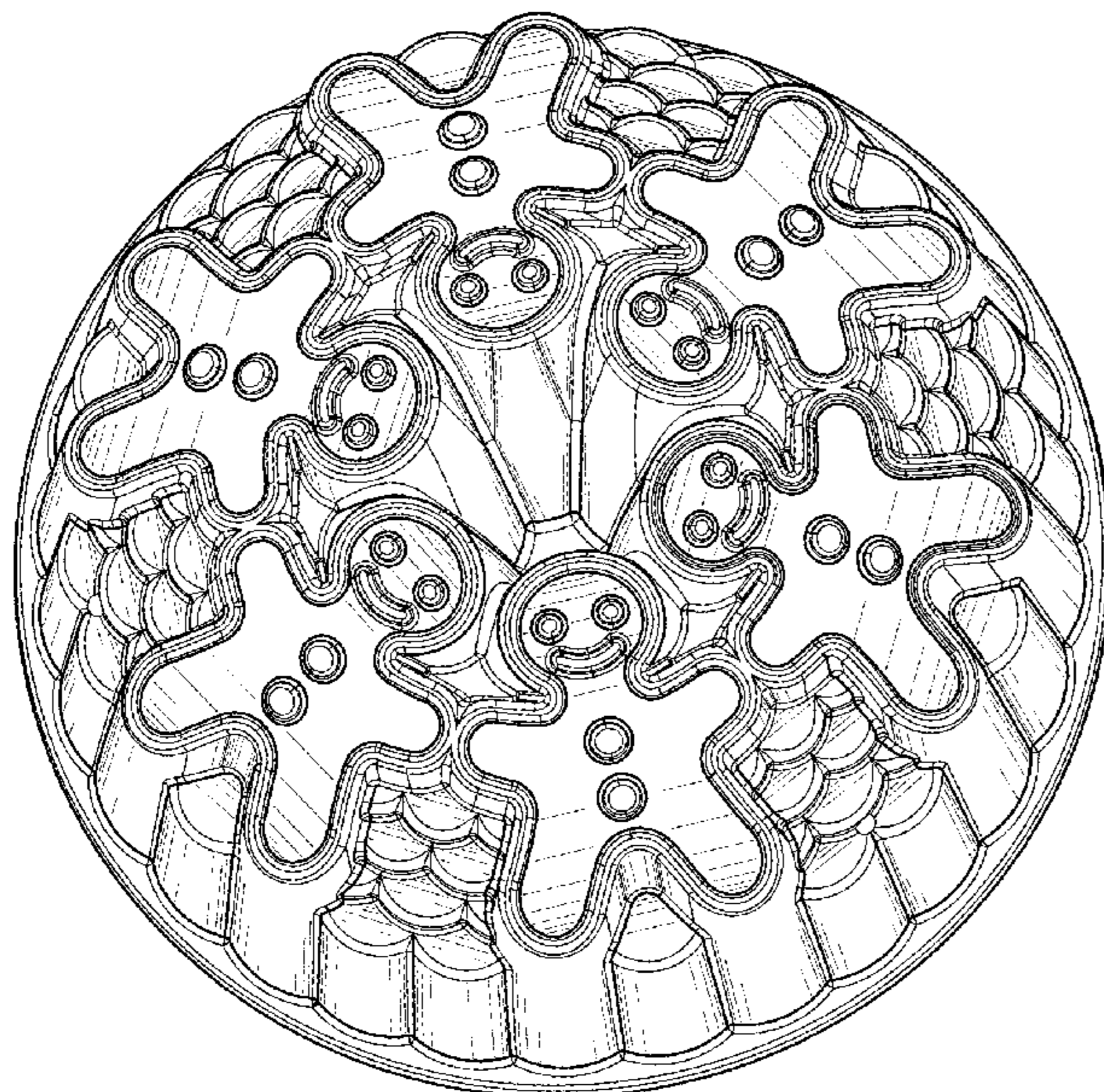

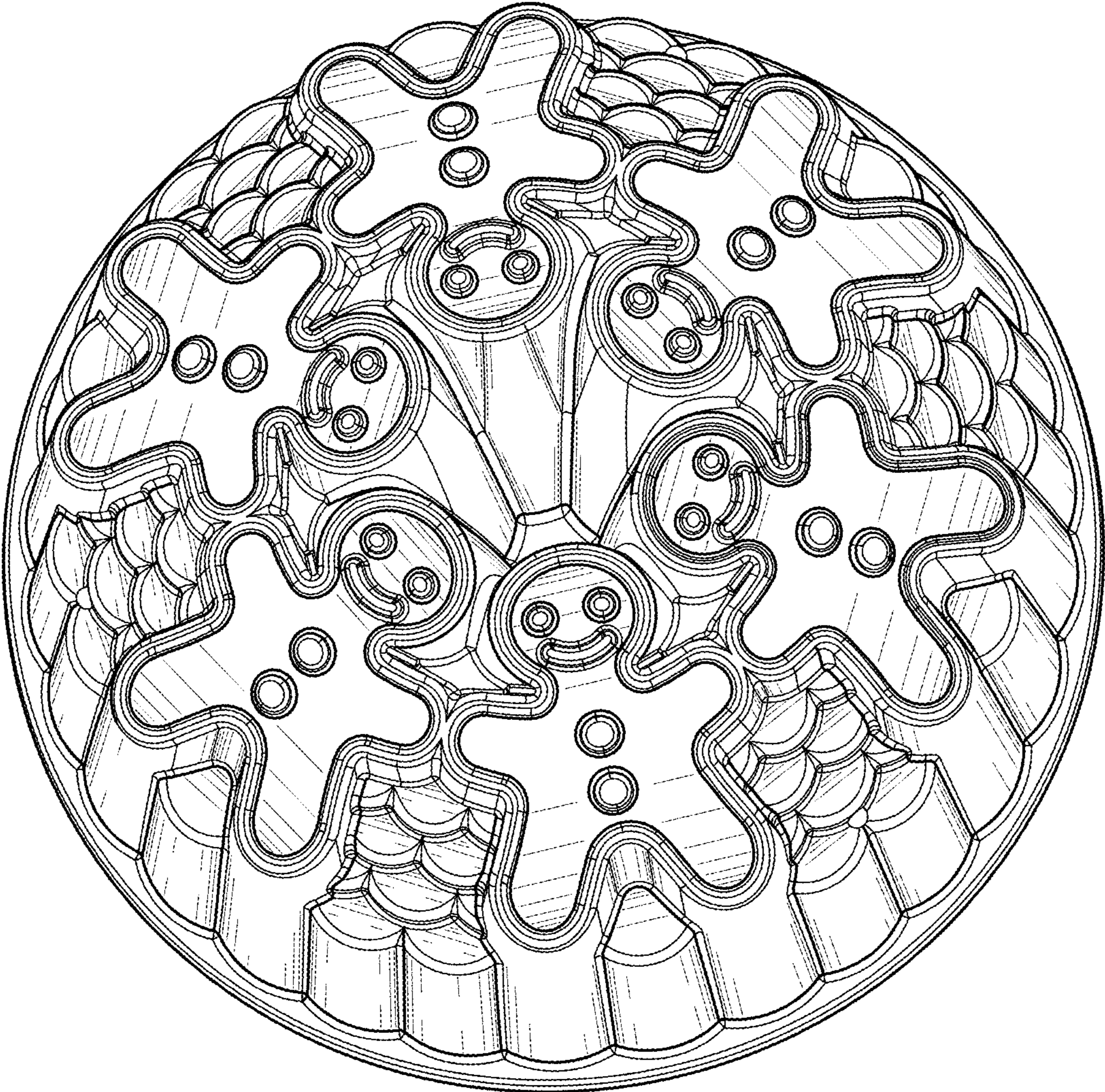

Fig. 1

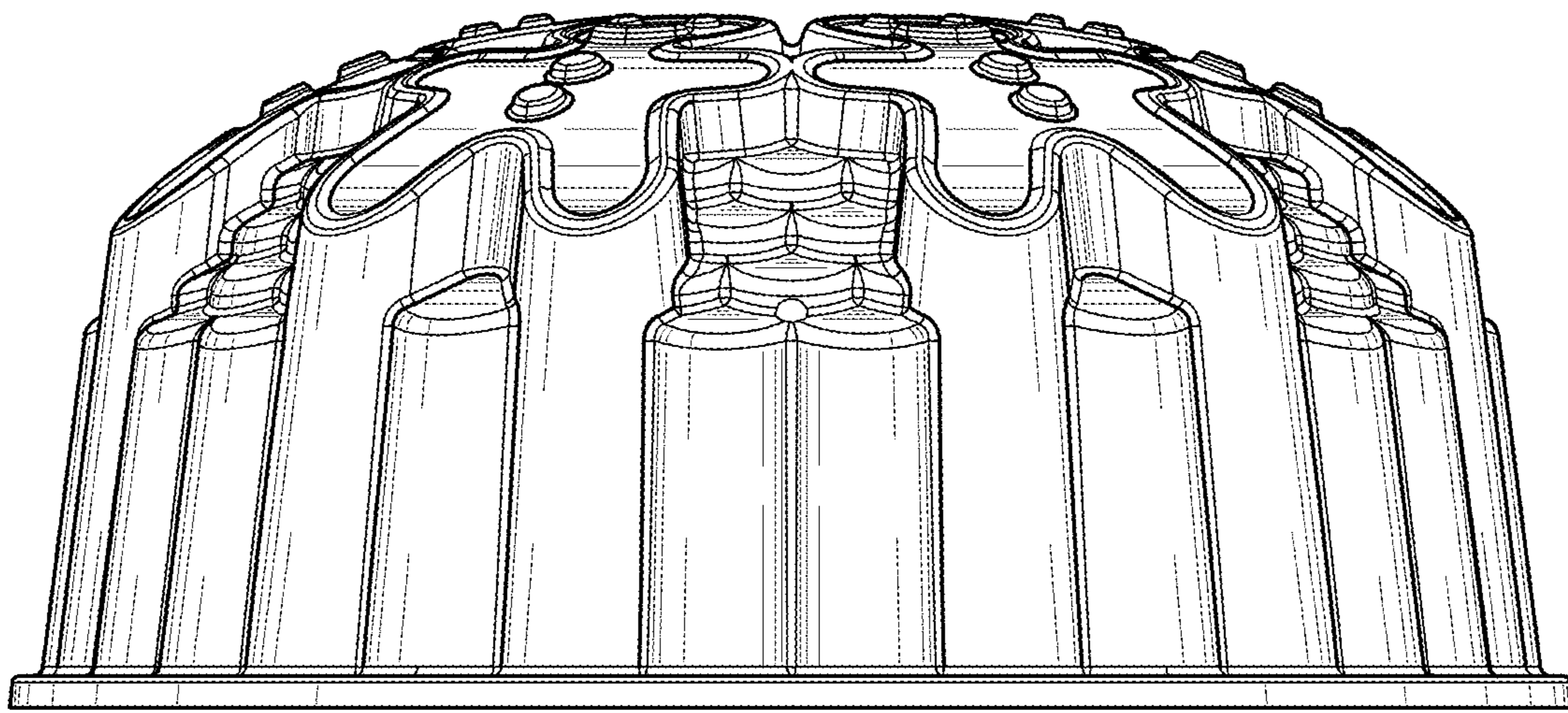

Fig. 2

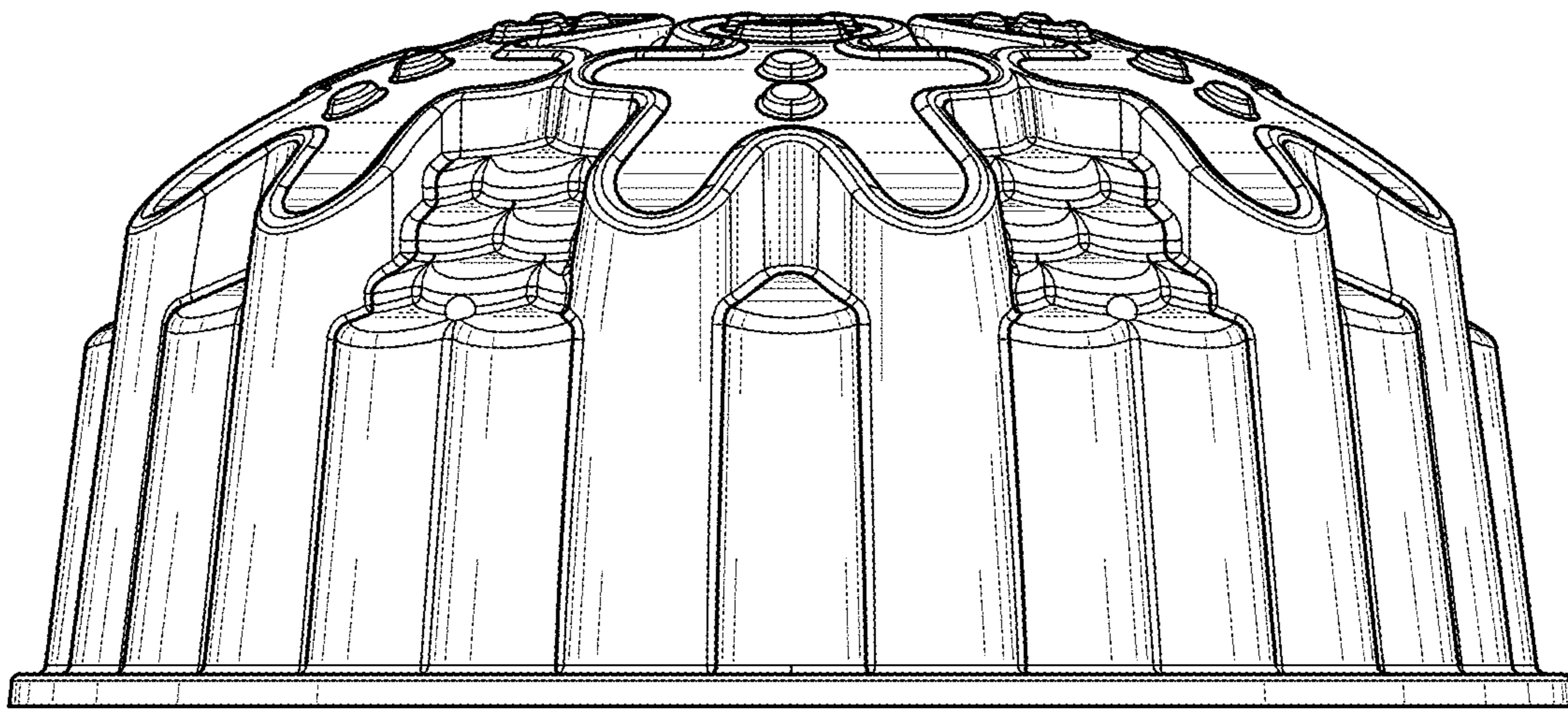

Fig. 3

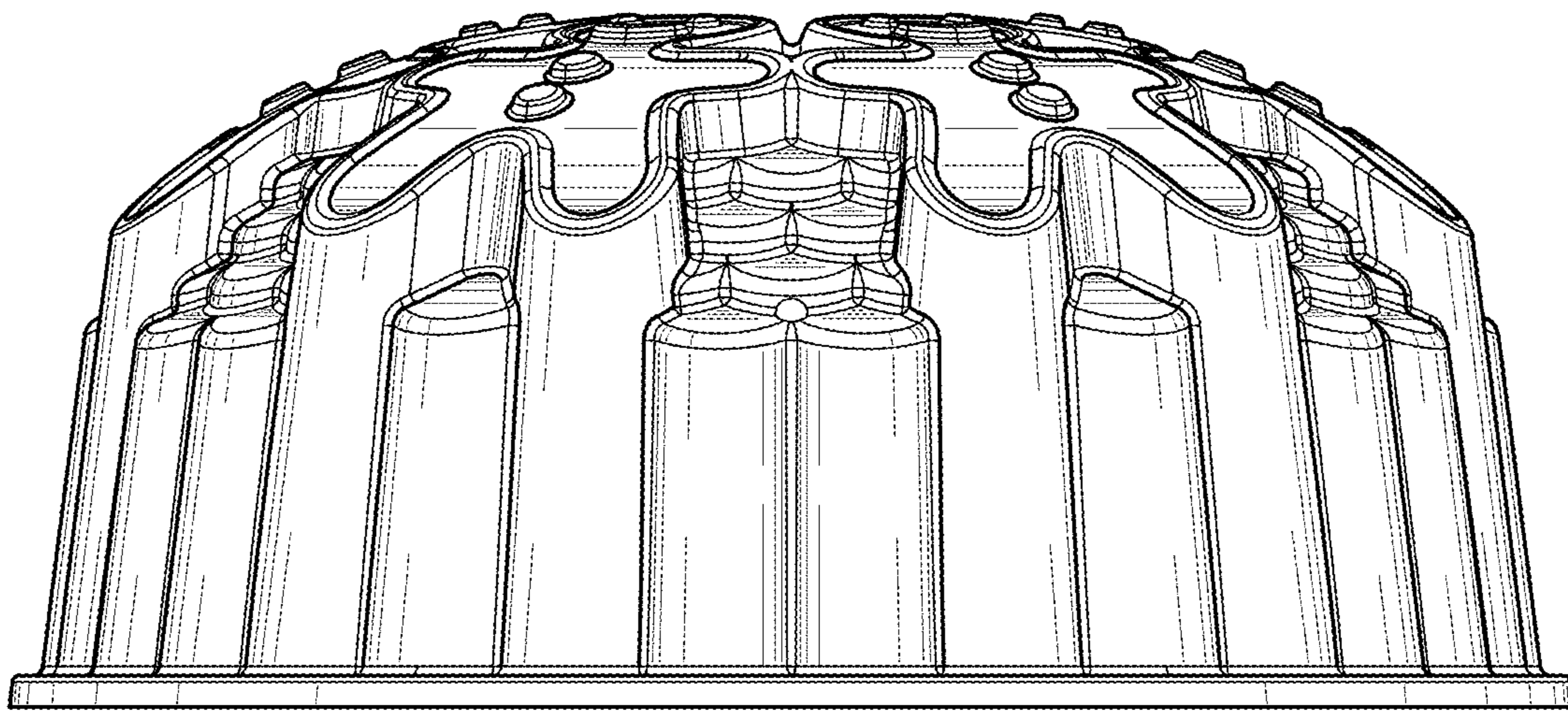

Fig. 4

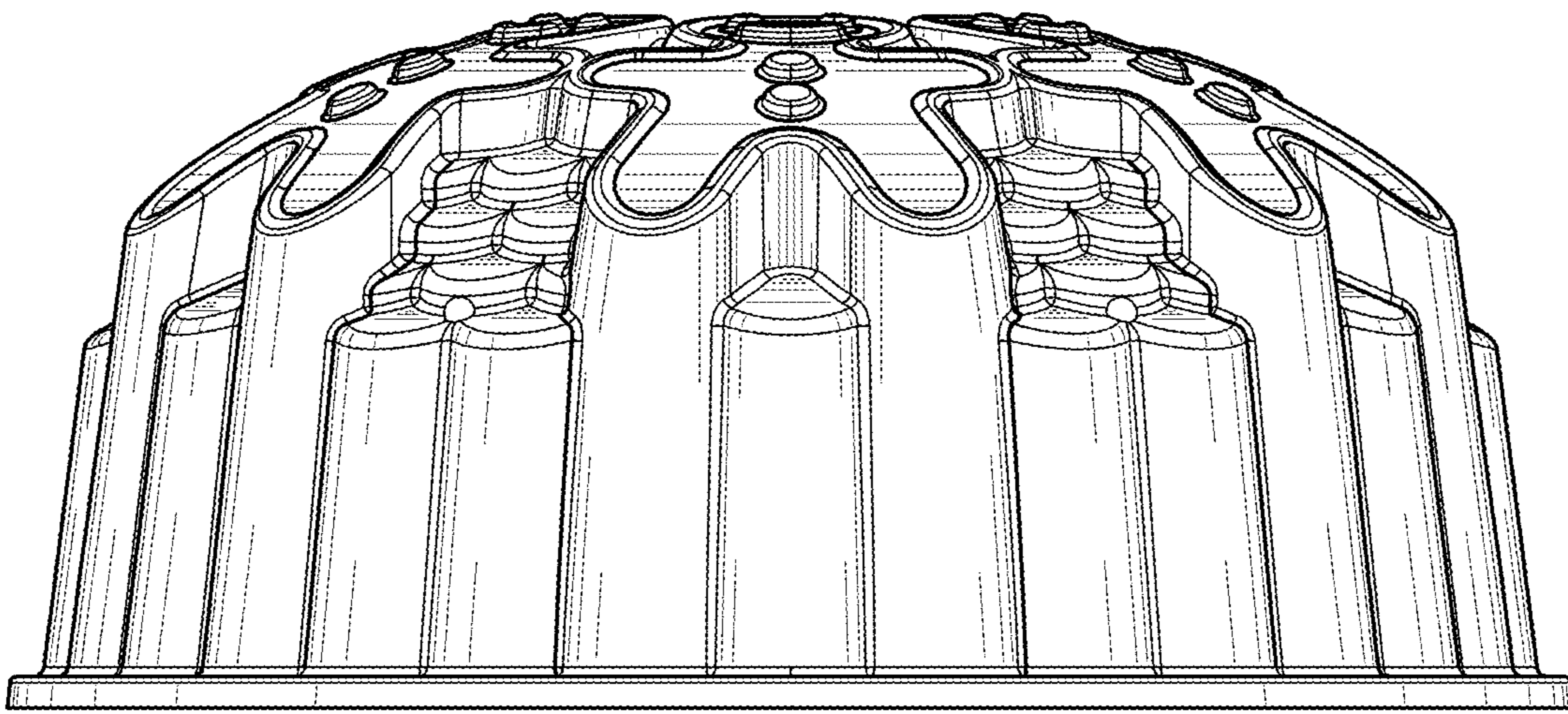

Fig. 5

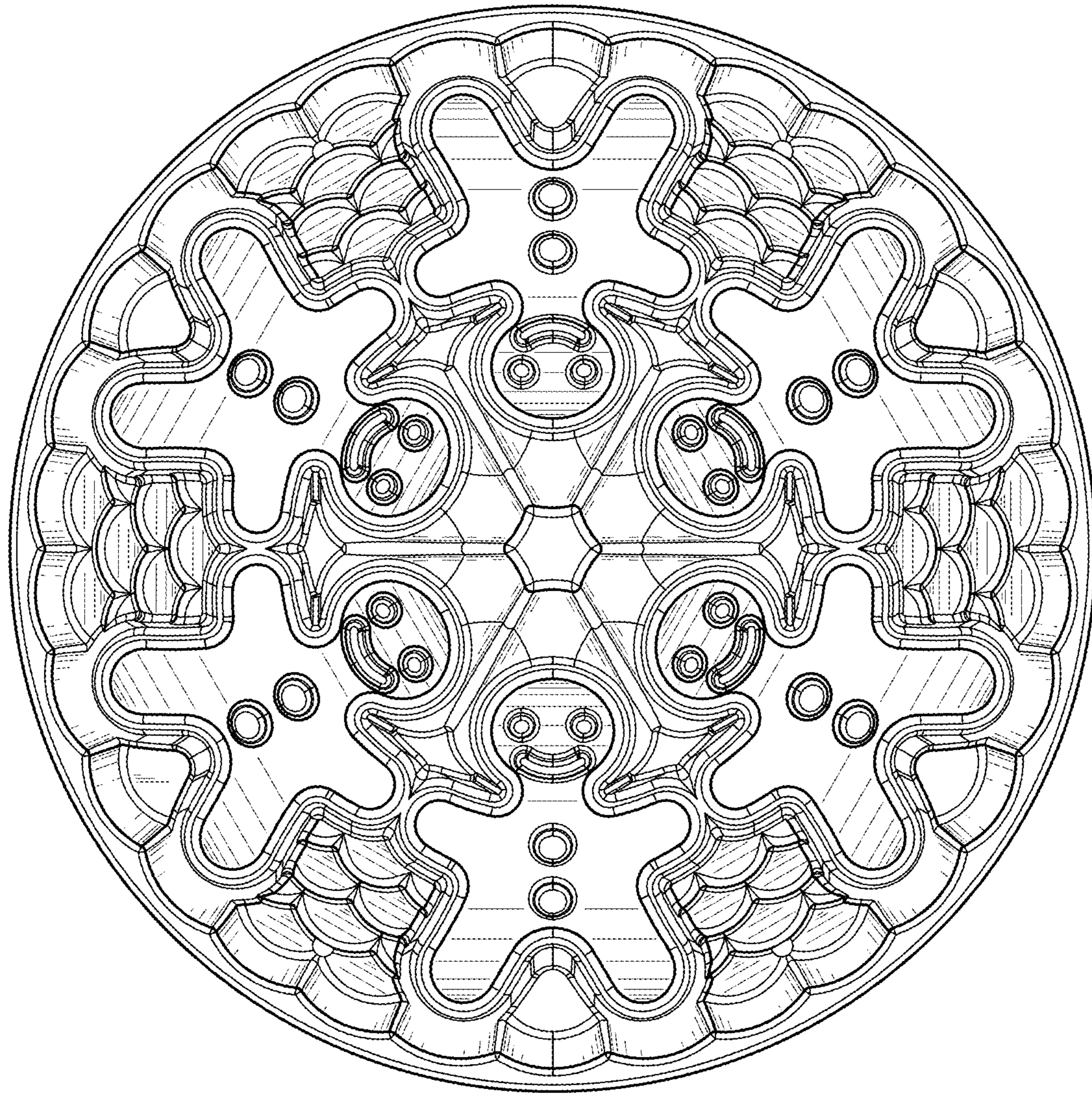

Fig. 6

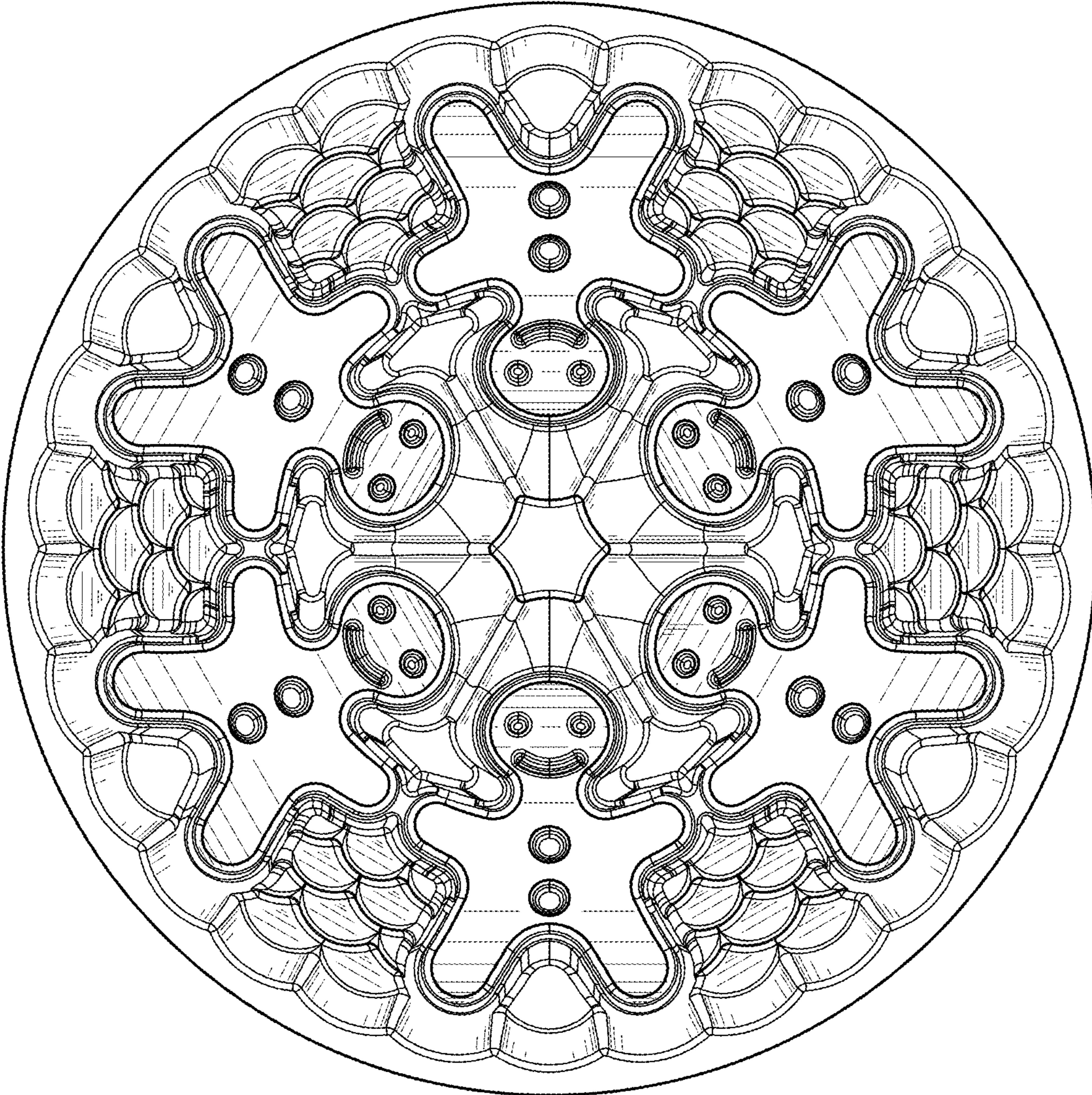

Fig. 7

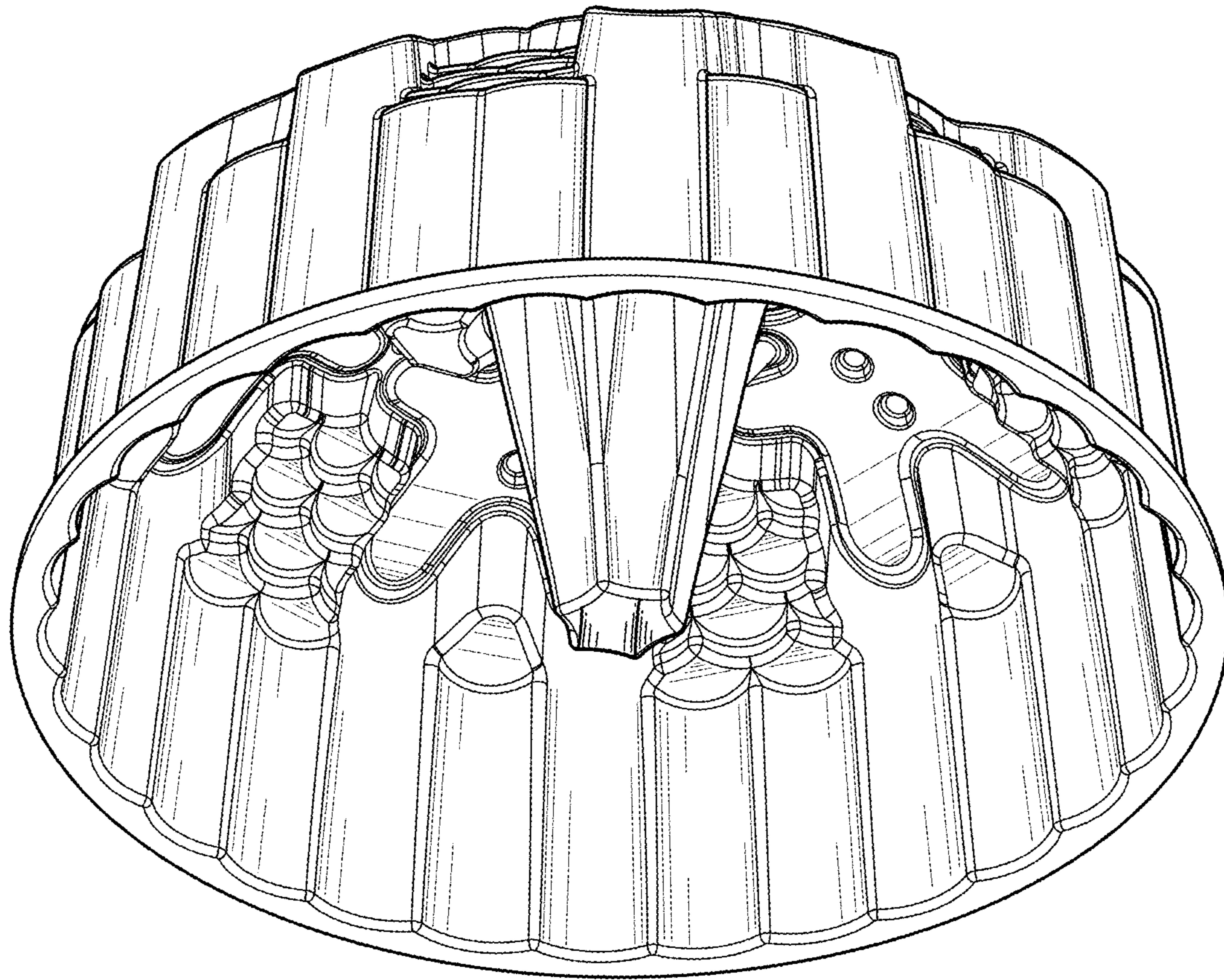

Fig. 8