



US00D871112S

(12) **United States Design Patent**
Sirge

(10) **Patent No.:** **US D871,112 S**

(45) **Date of Patent:** **** Dec. 31, 2019**

(54) **WRITING DESK**

(71) Applicant: **Walt Project OÜ**, Võru (EE)

(72) Inventor: **Valter-Johannes Sirge**, Võru (EE)

(73) Assignee: **Walt Project OÜ**, Võru (EE)

(**) Term: **15 Years**

(21) Appl. No.: **29/644,035**

(22) Filed: **Apr. 13, 2018**

(30) **Foreign Application Priority Data**

Oct. 13, 2017 (EM) 004401008-0001

Oct. 13, 2017 (EM) 004401008-0002

(51) **LOC (12) Cl.** **06-03**

(52) **U.S. Cl.**
USPC **D6/655.14**

(58) **Field of Classification Search**

USPC D6/641, 642, 648, 648.1, 650, 650.1,
D6/655, 655.1, 655.14, 656, 656.1,
D6/656.11, 656.12, 656.13, 656.14,
D6/656.15, 656.16, 656.17, 656.18,
D6/656.19, 675, 686, 688.14, 688.15,
D6/691, 691.5, 691.6, 691.7, 697

(Continued)

(56) **References Cited**

U.S. PATENT DOCUMENTS

1,549,979 A * 8/1925 Hofstad A47B 3/087
190/12 R

D101,100 S * 9/1936 Bate D6/655
(Continued)

OTHER PUBLICATIONS

Airlift, posted at Wayfair.com, posted on Jul. 6, 2018, site visited
May 16, 2019. online, available from internet: <https://www.wayfair.com>.

com/furniture/pdp/seville-classics-airlift-52-electric-height-adjustable-standing-desk-w001173239.html (Year: 2018).*

(Continued)

Primary Examiner — Mary Ann Calabrese

Assistant Examiner — Catherine Ho

(74) *Attorney, Agent, or Firm* — Berggren LLP

(57) **CLAIM**

I claim the ornamental design for a writing desk, as shown and described.

DESCRIPTION

FIG. 1 shows a front view of a writing desk, showing my new design;

FIG. 2 shows a front view of a writing desk in a raised position;

FIG. 3 shows a back view of FIG. 1;

FIG. 4 shows the back view of FIG. 2;

FIG. 5 shows a side view of FIG. 1, the opposite side view being a mirror image thereof;

FIG. 6 shows a side view of FIG. 2, the opposite side view being a mirror image thereof;

FIG. 7 shows a side view of a writing desk in a raised position with the drawer portion extended, the opposite side being a mirror image thereof;

FIG. 8 shows a top view of a writing desk;

FIG. 9 shows a top view of a writing desk with the drawer portions extended;

FIG. 10 shows a bottom view of a writing desk with the drawer portions extended;

FIG. 11 shows a bottom view of FIG. 8;

FIG. 12 shows a perspective view of FIG. 1;

FIG. 13 shows a perspective view of FIG. 2;

FIG. 14 shows a front perspective view of FIG. 7; and,

FIG. 15 shows another front perspective view thereof.

The broken line portions of the figure drawings are included to show portions of the article that form no part of the claimed design.

1 Claim, 15 Drawing Sheets

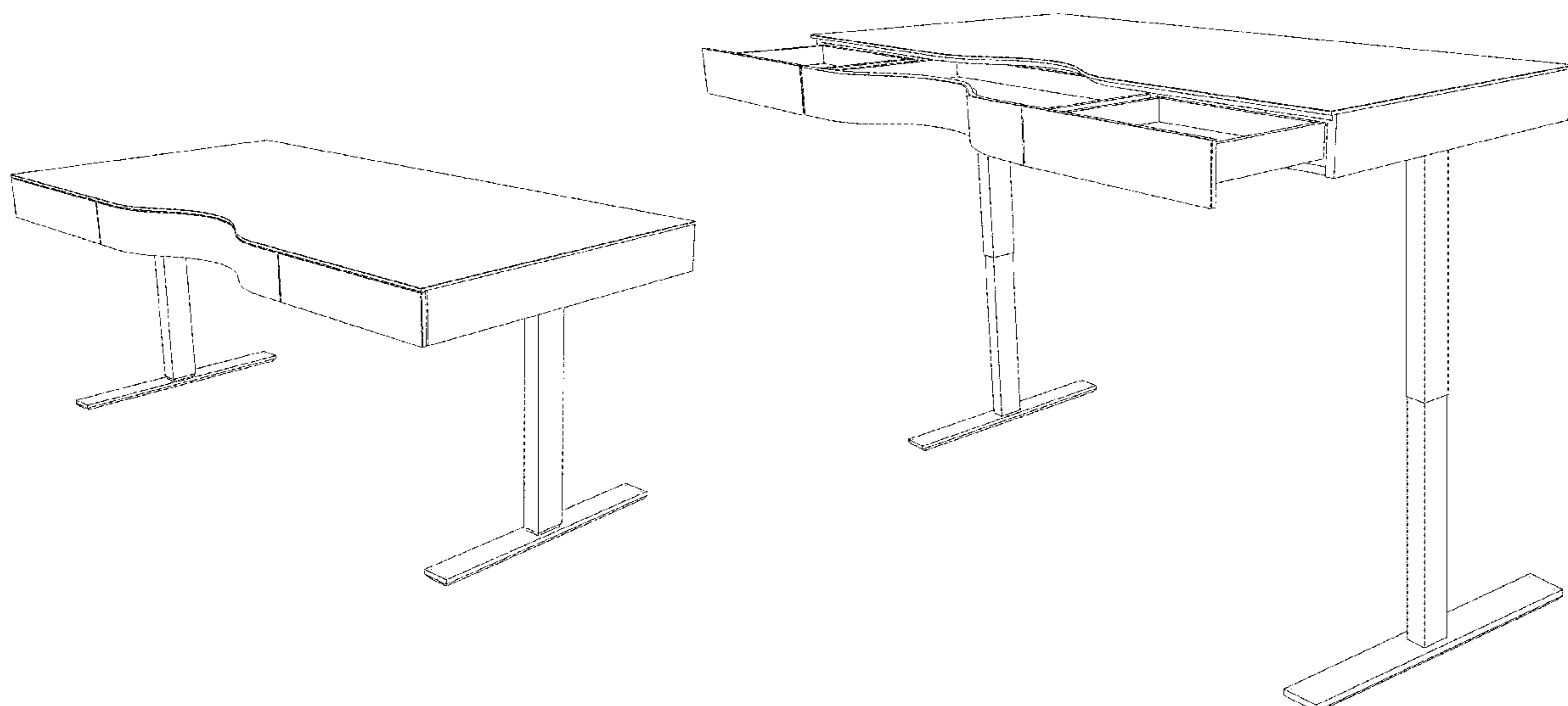

(58) **Field of Classification Search**

CPC A47B 9/00; A47B 9/02; A47B 9/04; A47B
9/12; A47B 2200/0035; A47B 2200/005;
A47B 2200/0056

See application file for complete search history.

(56) **References Cited**

U.S. PATENT DOCUMENTS

D155,976 S * 11/1949 Dunham D6/655
D303,882 S * 10/1989 Sottsas D6/652
D305,188 S * 12/1989 van Engeland D6/656.17
D510,821 S * 10/2005 Madison D6/655.21
D644,044 S * 8/2011 Kitajima D6/656.17
D776,961 S * 1/2017 Yamamoto D6/656.16
D794,359 S * 8/2017 Yamamoto D6/656
D841,367 S * 2/2019 Tarkiainen D6/648.1
D846,917 S * 4/2019 Hu D6/656.17
2018/0000240 A1 * 1/2018 Yamamoto A47B 9/20

OTHER PUBLICATIONS

Django, posted at Wayfair.com, posted on May 2, 2018, site visited
May 16, 2019. online, available from internet: <https://www.wayfair.com/furniture/pdp/17-stories-django-height-adjustable-standing-desk-w000542928.html> (Year: 2018).*

* cited by examiner



FIG. 1

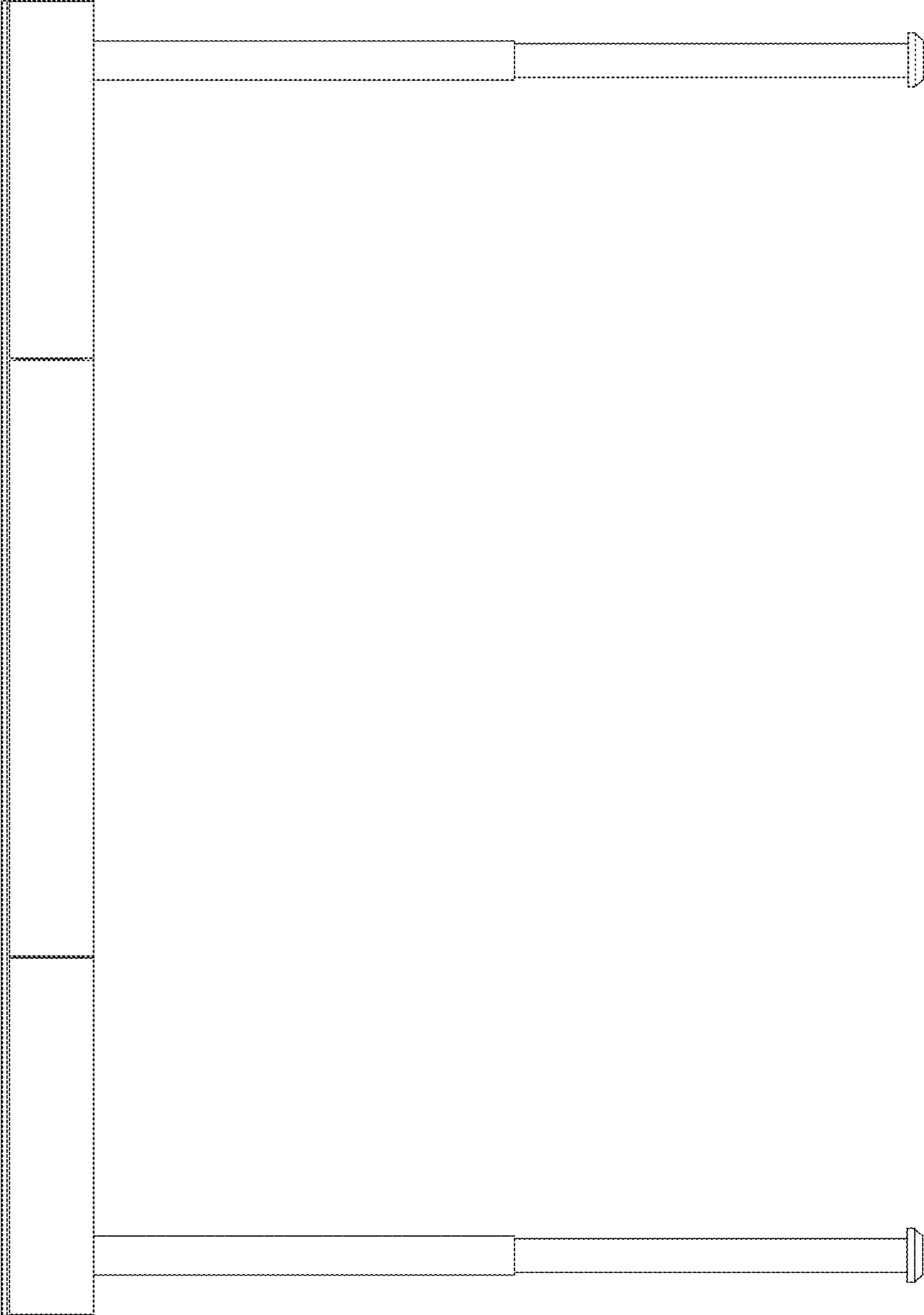

FIG. 2

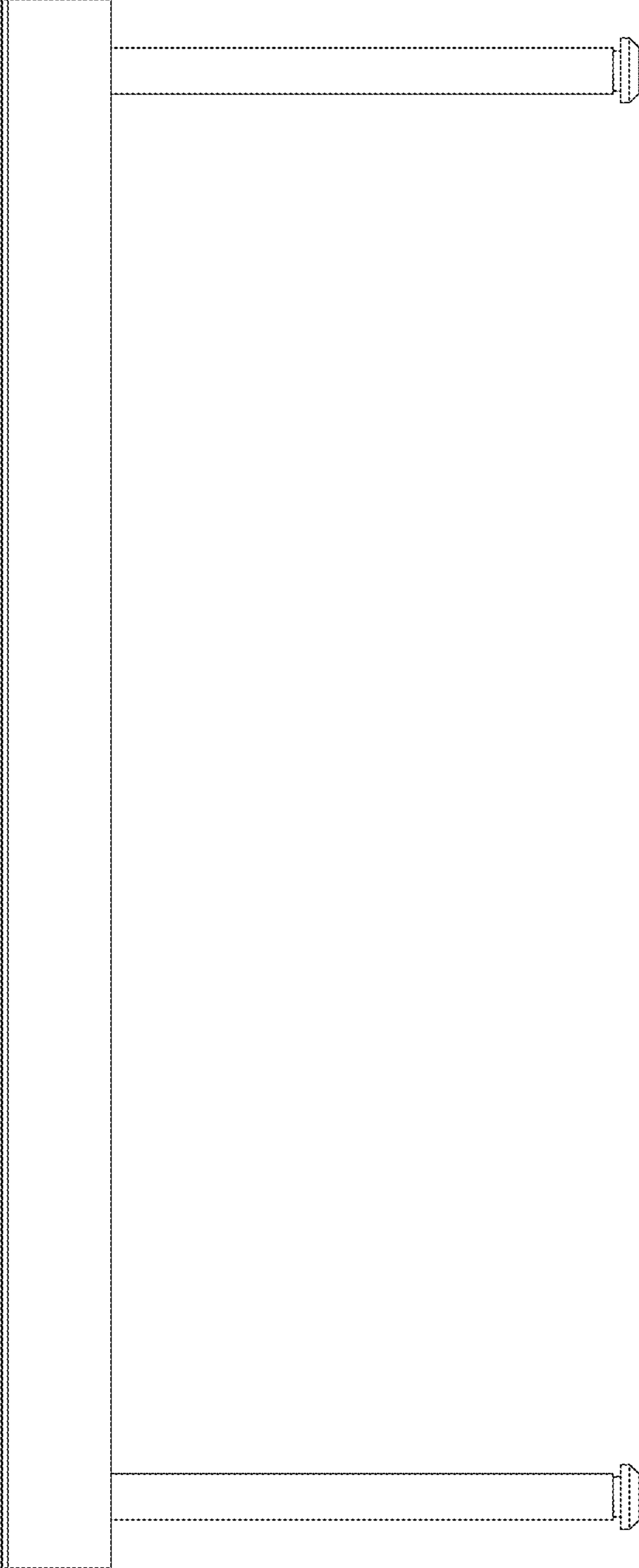

FIG. 3

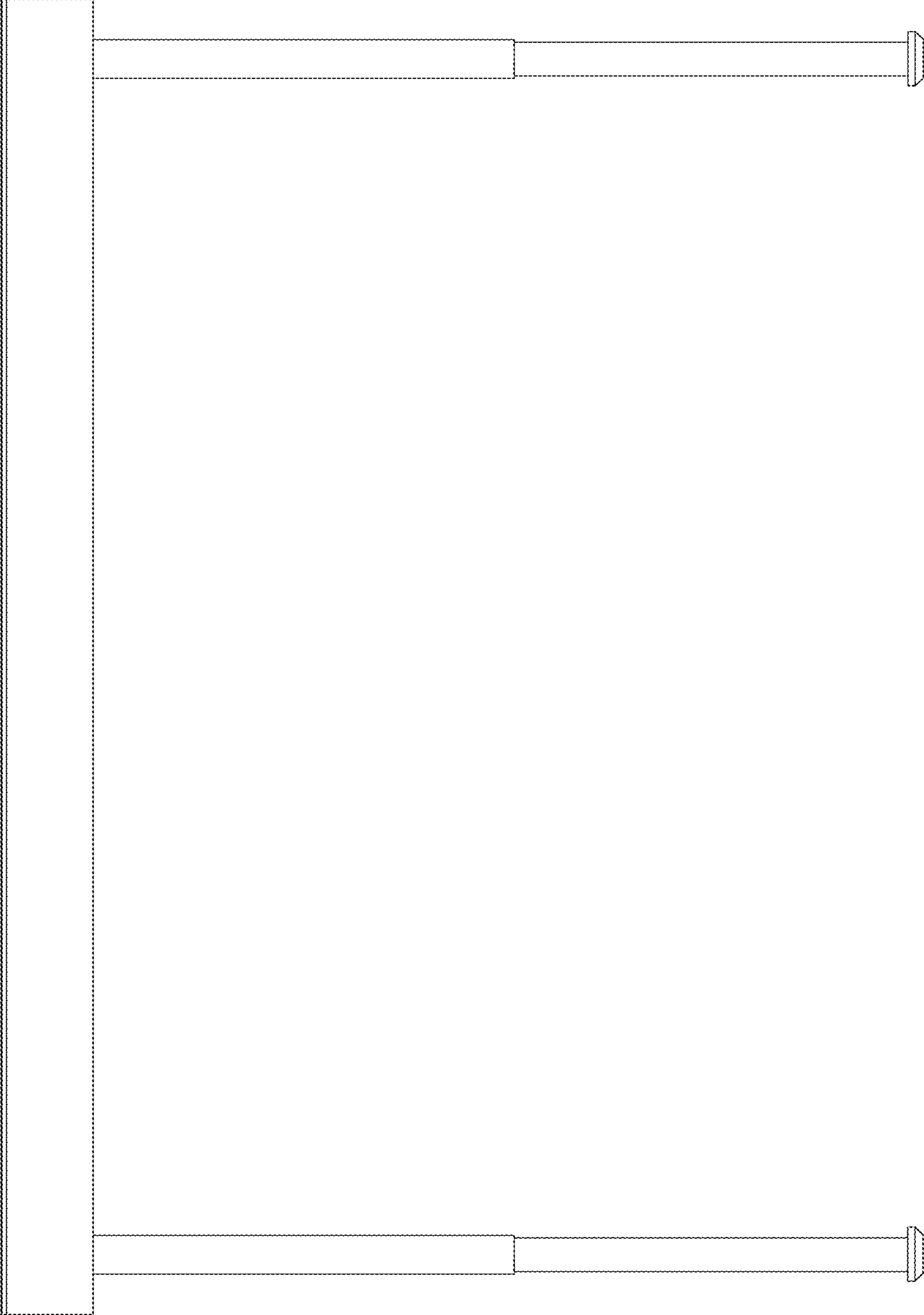

FIG. 4

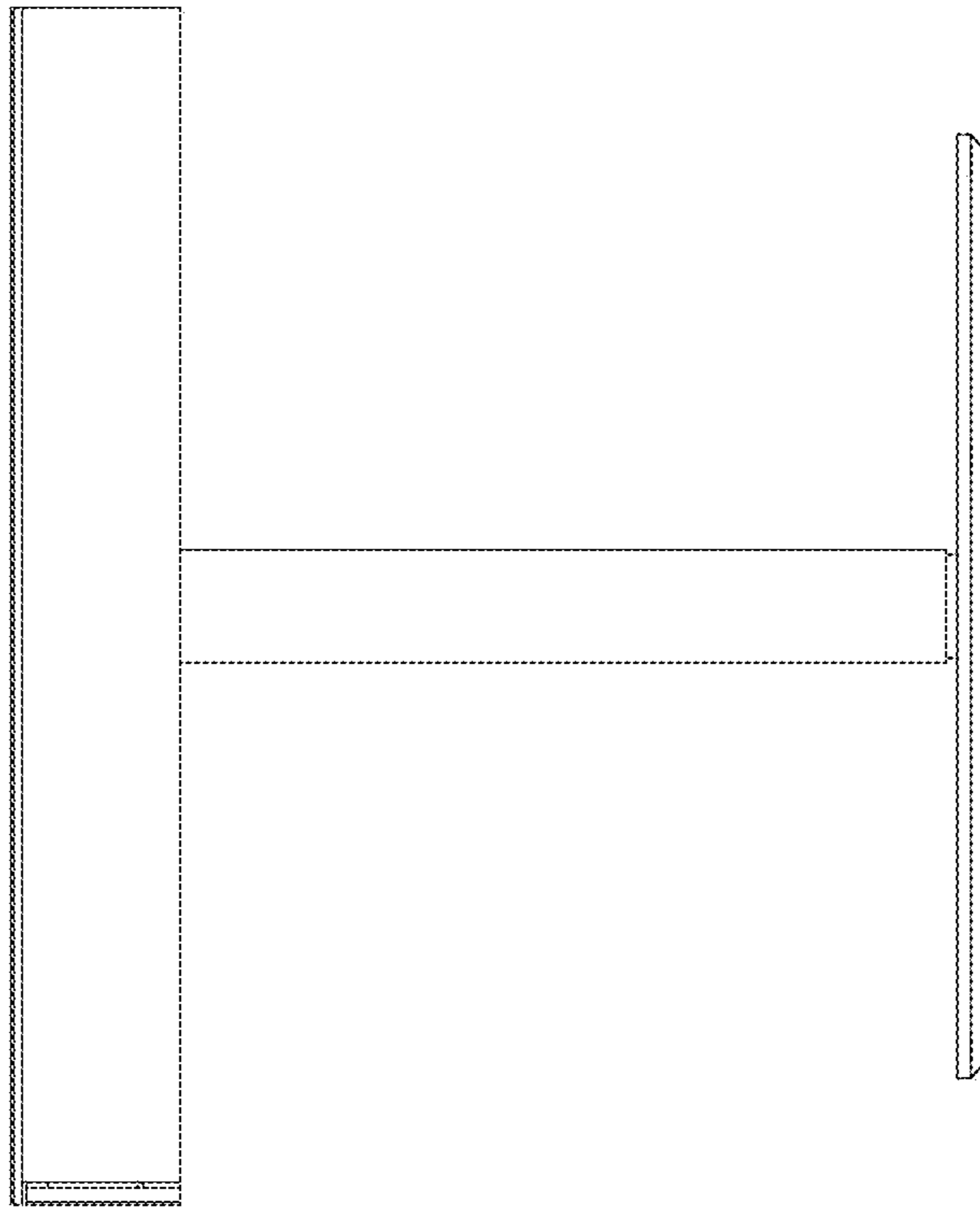

FIG. 5

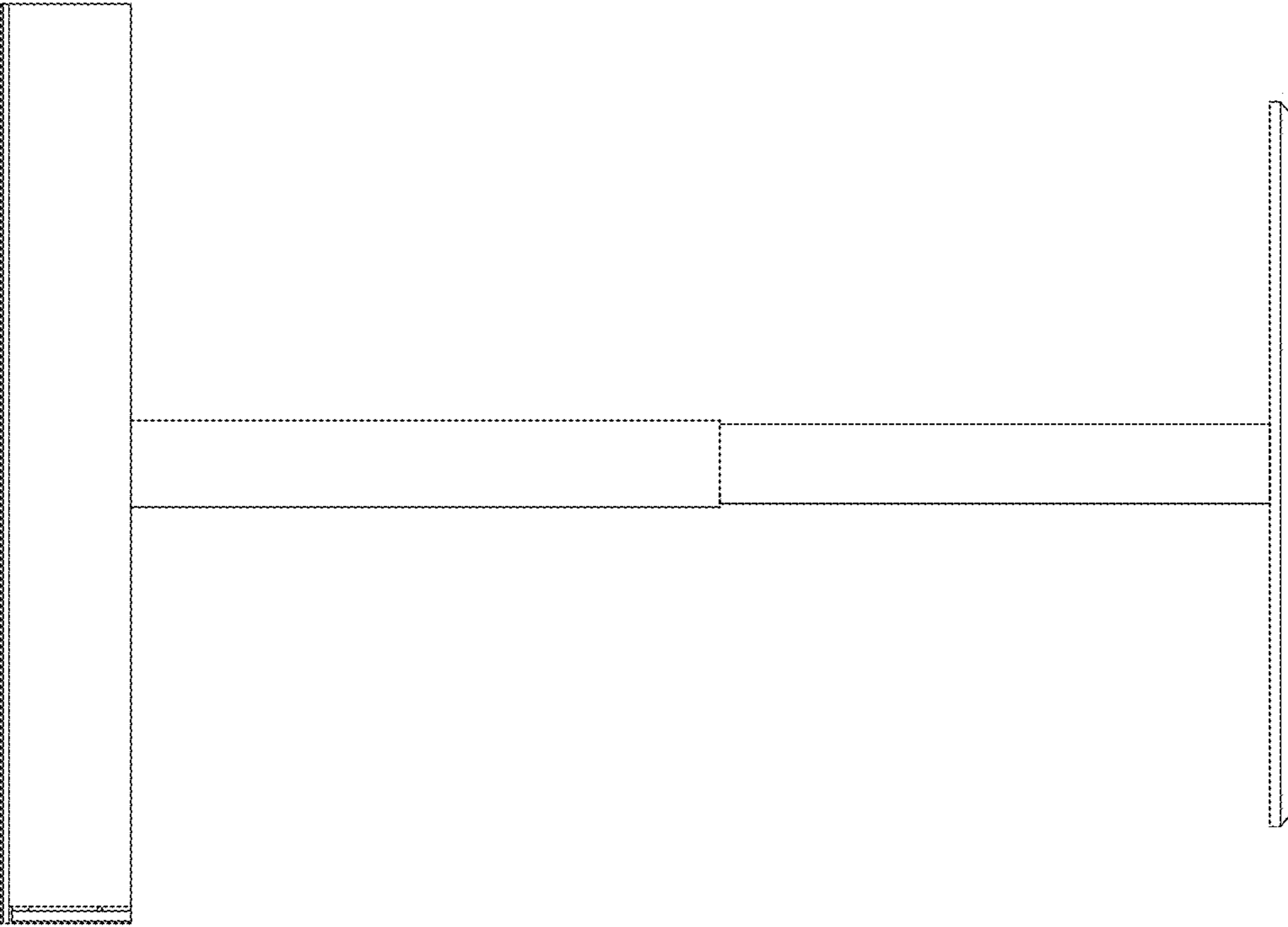

FIG. 6

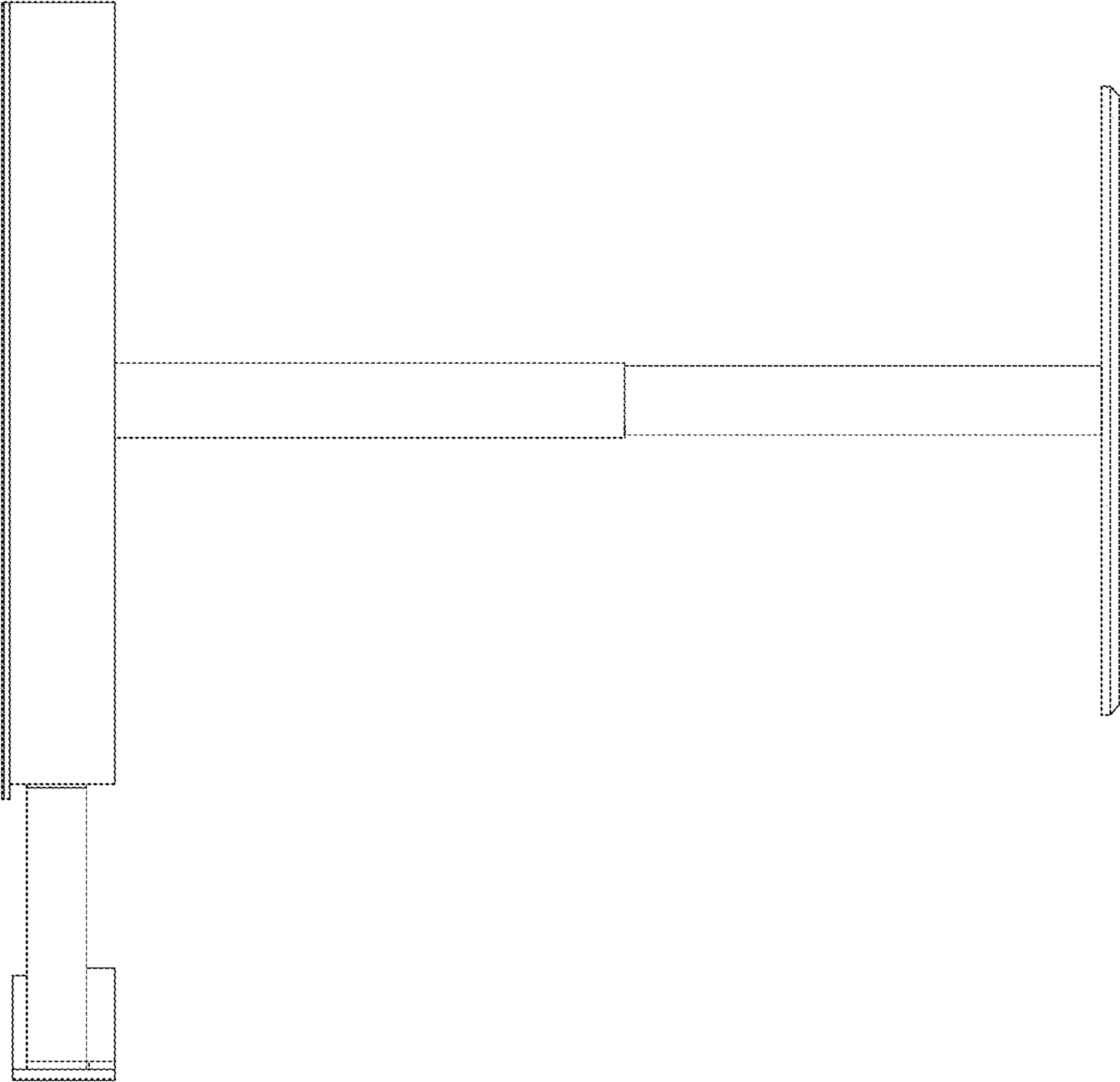

FIG. 7

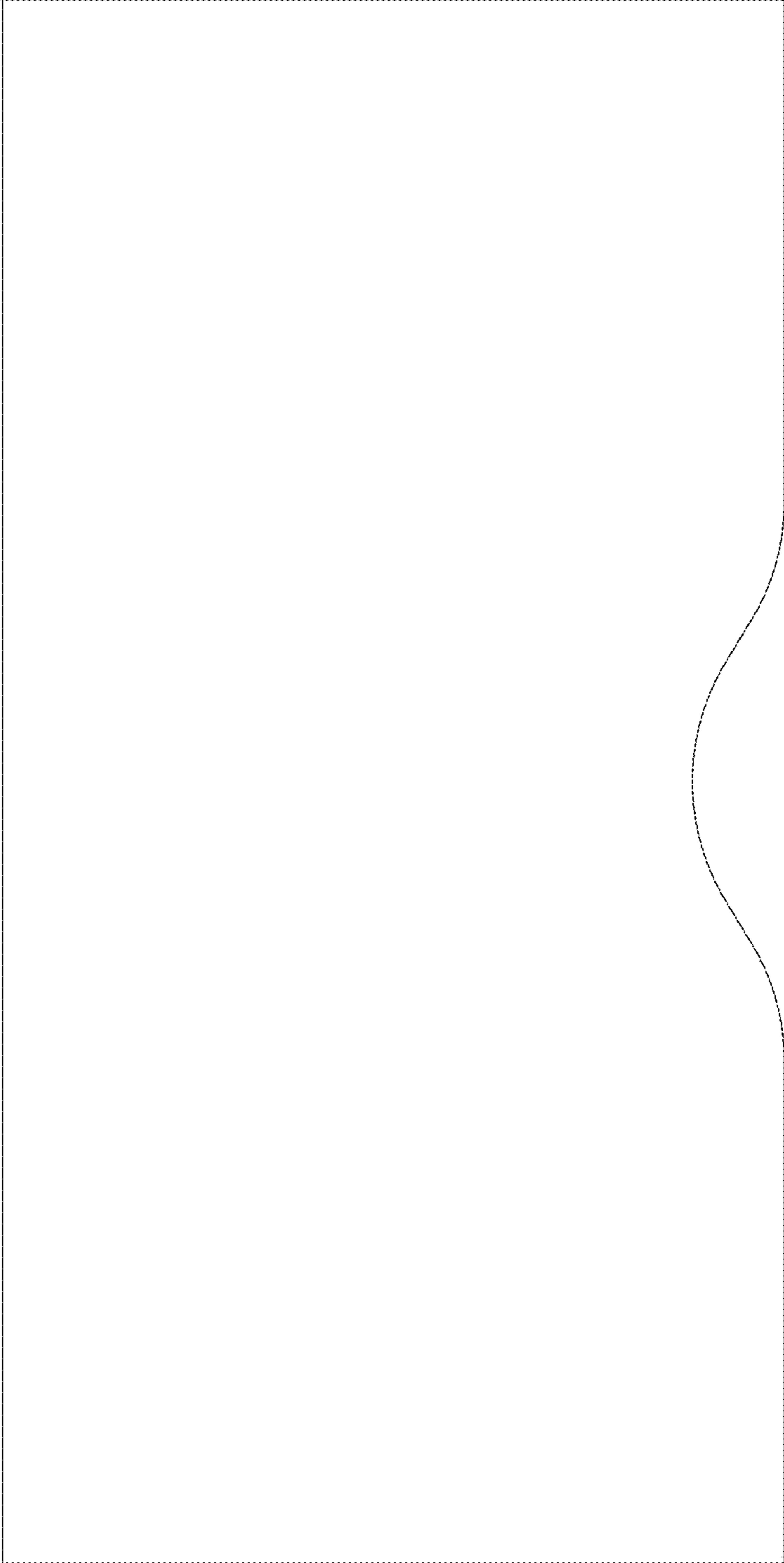

FIG. 8

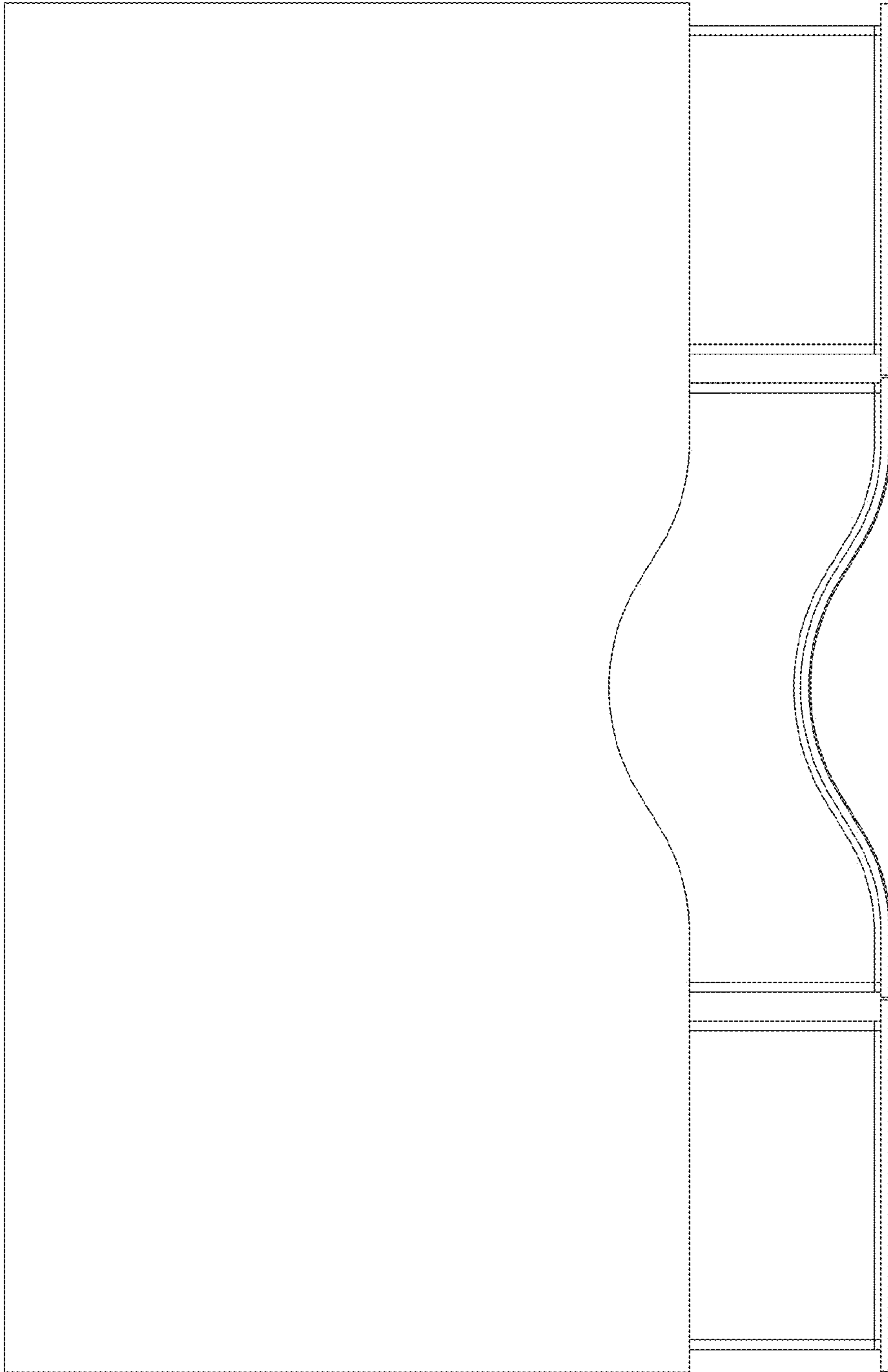

FIG. 9

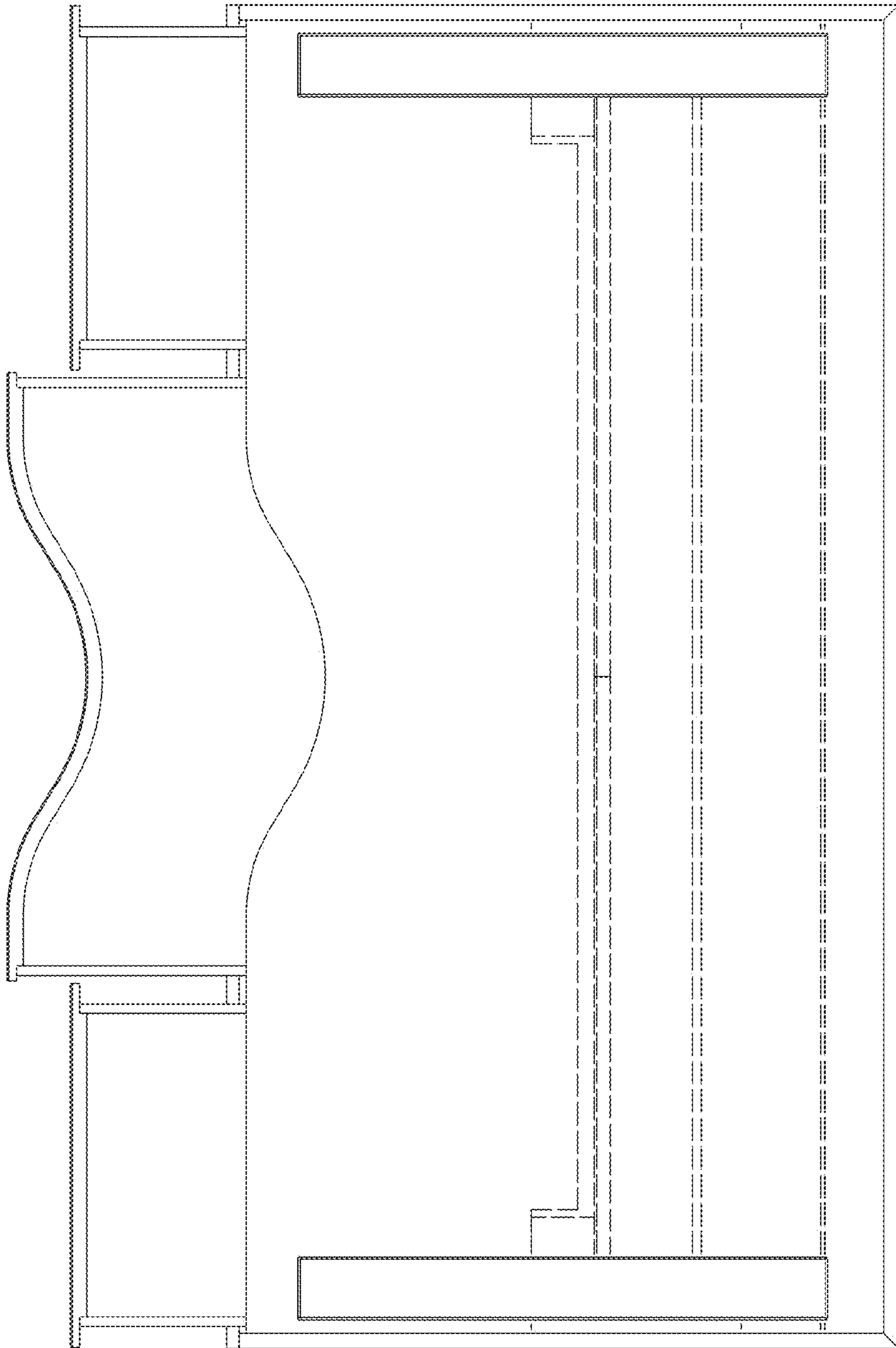

FIG. 10

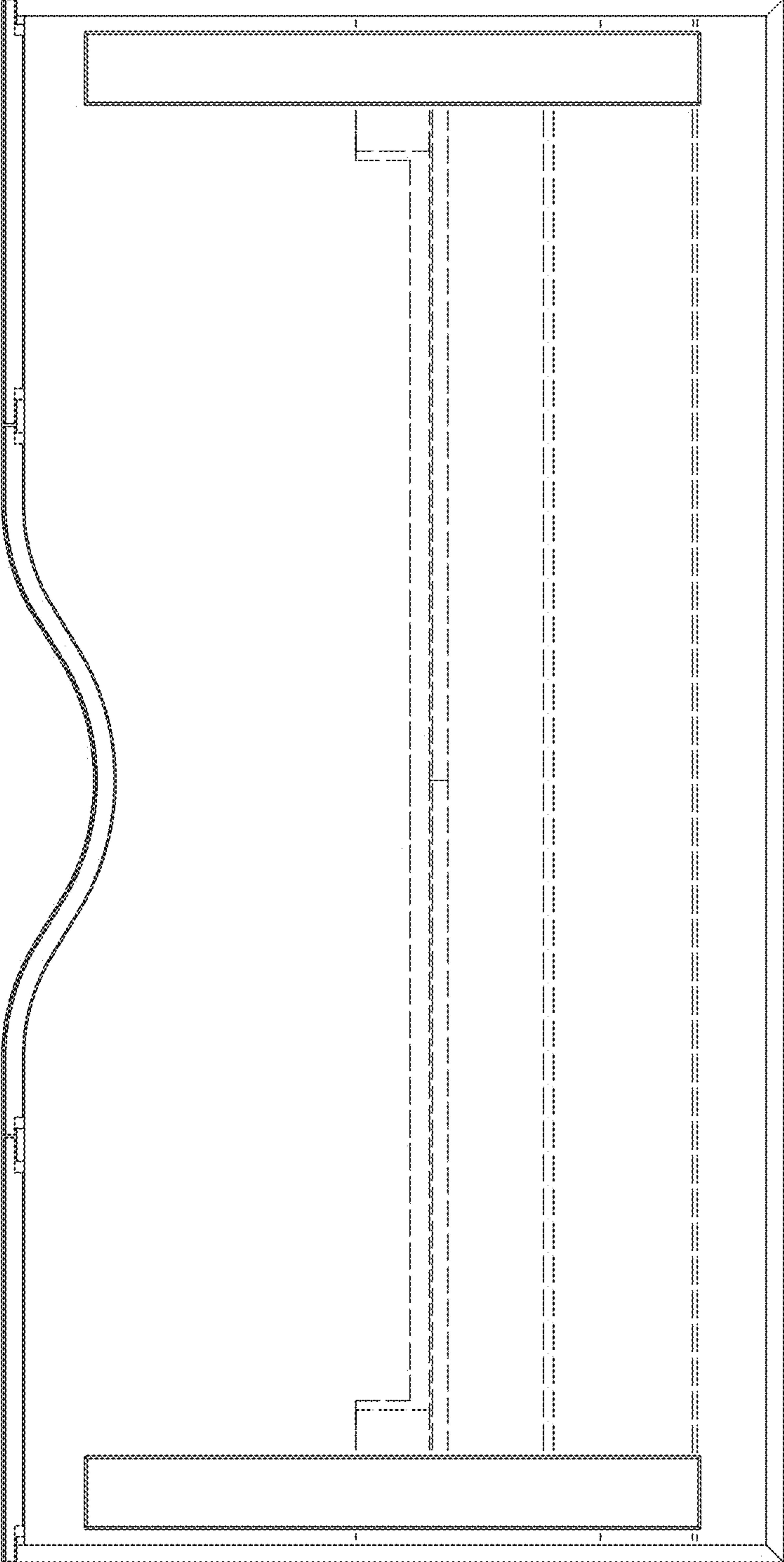

FIG. 11

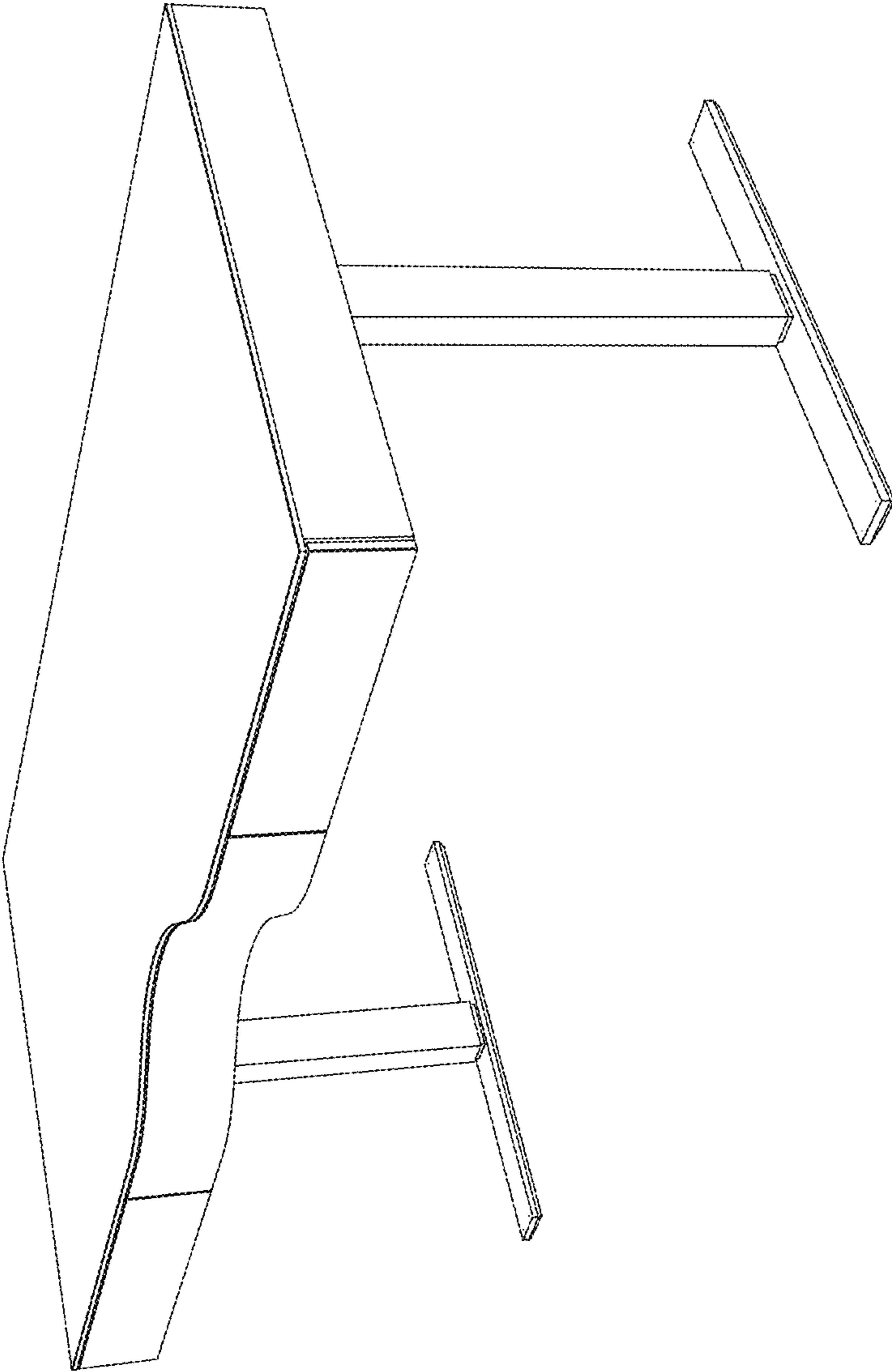

FIG. 12

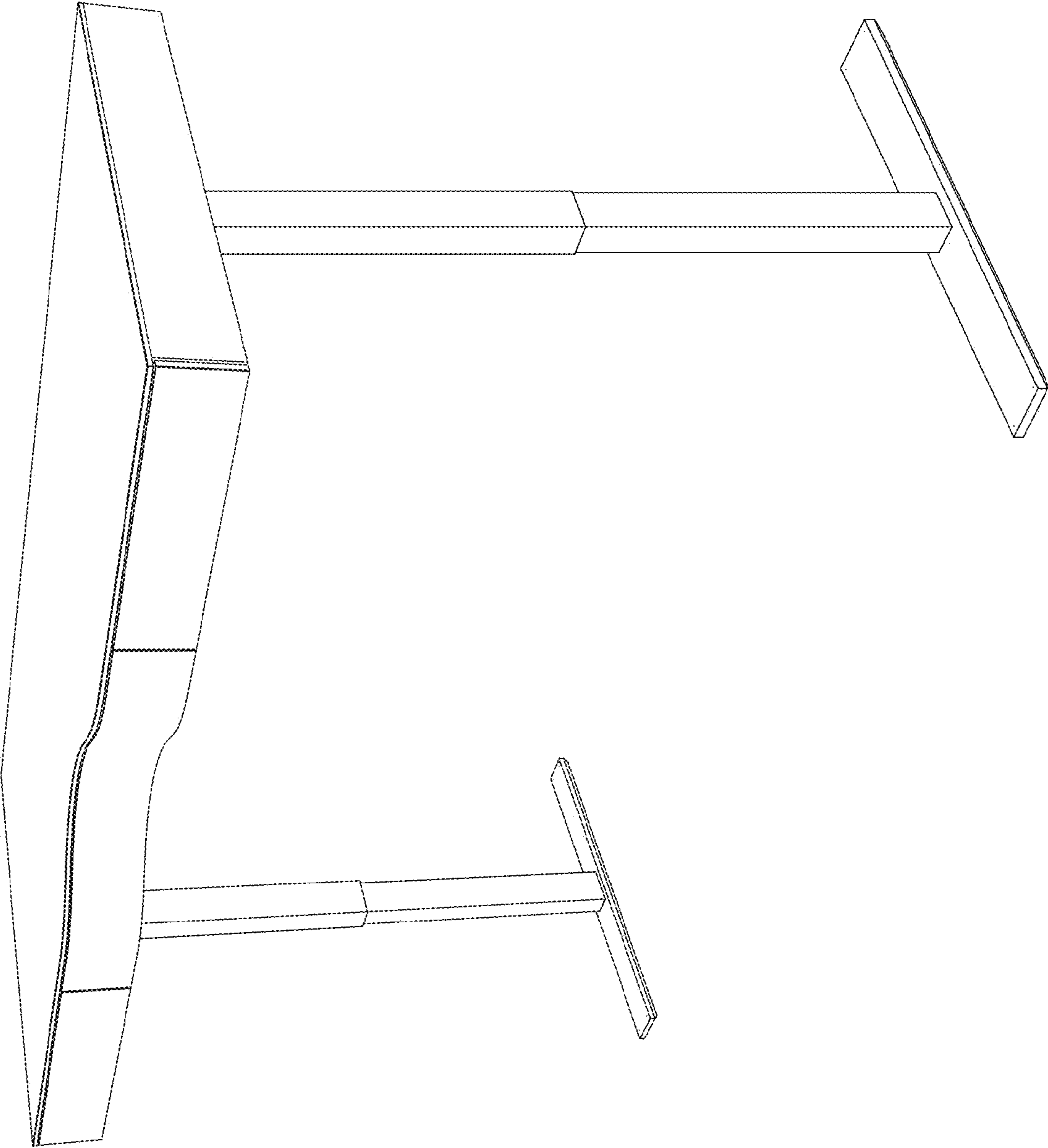

FIG. 13

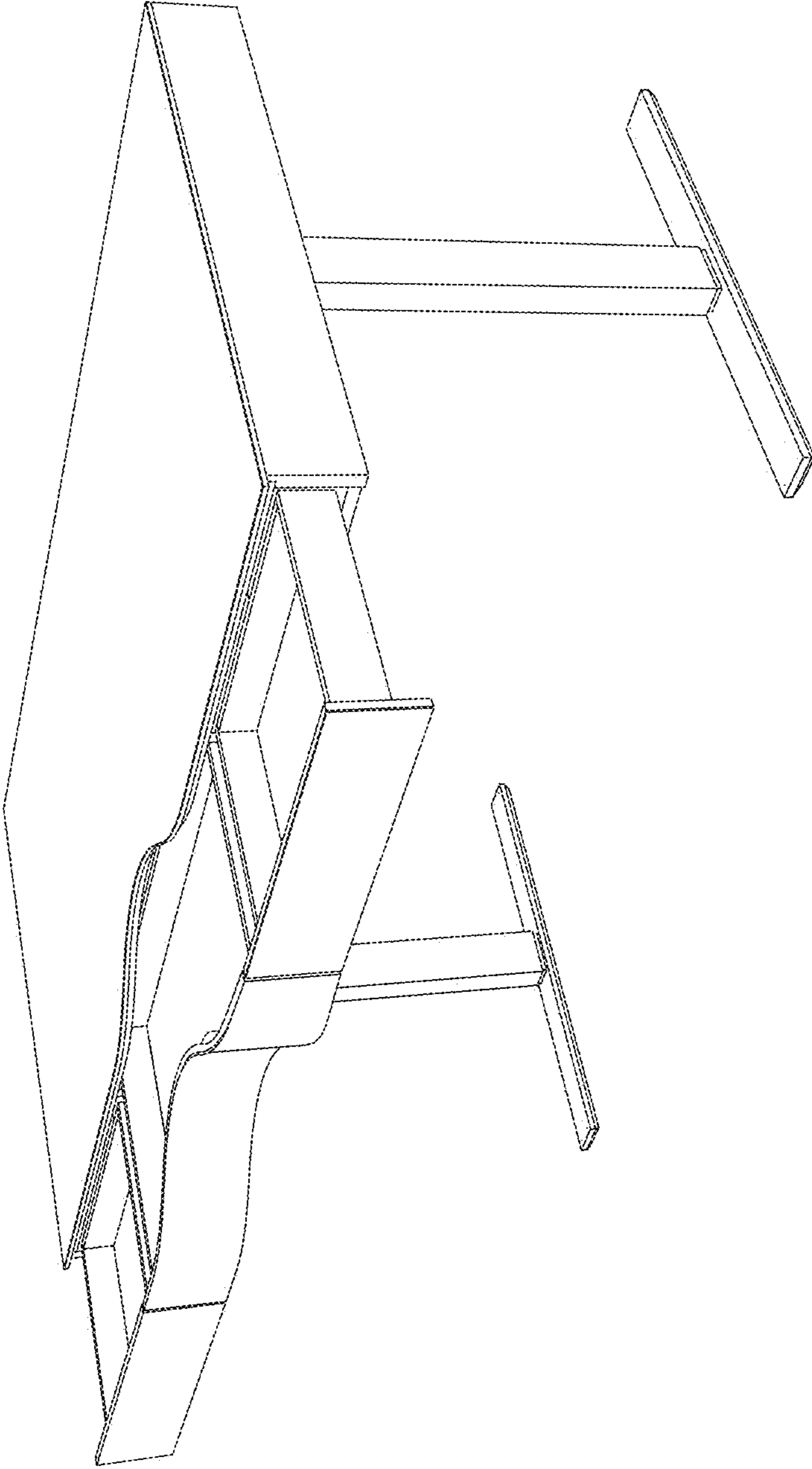

FIG. 14

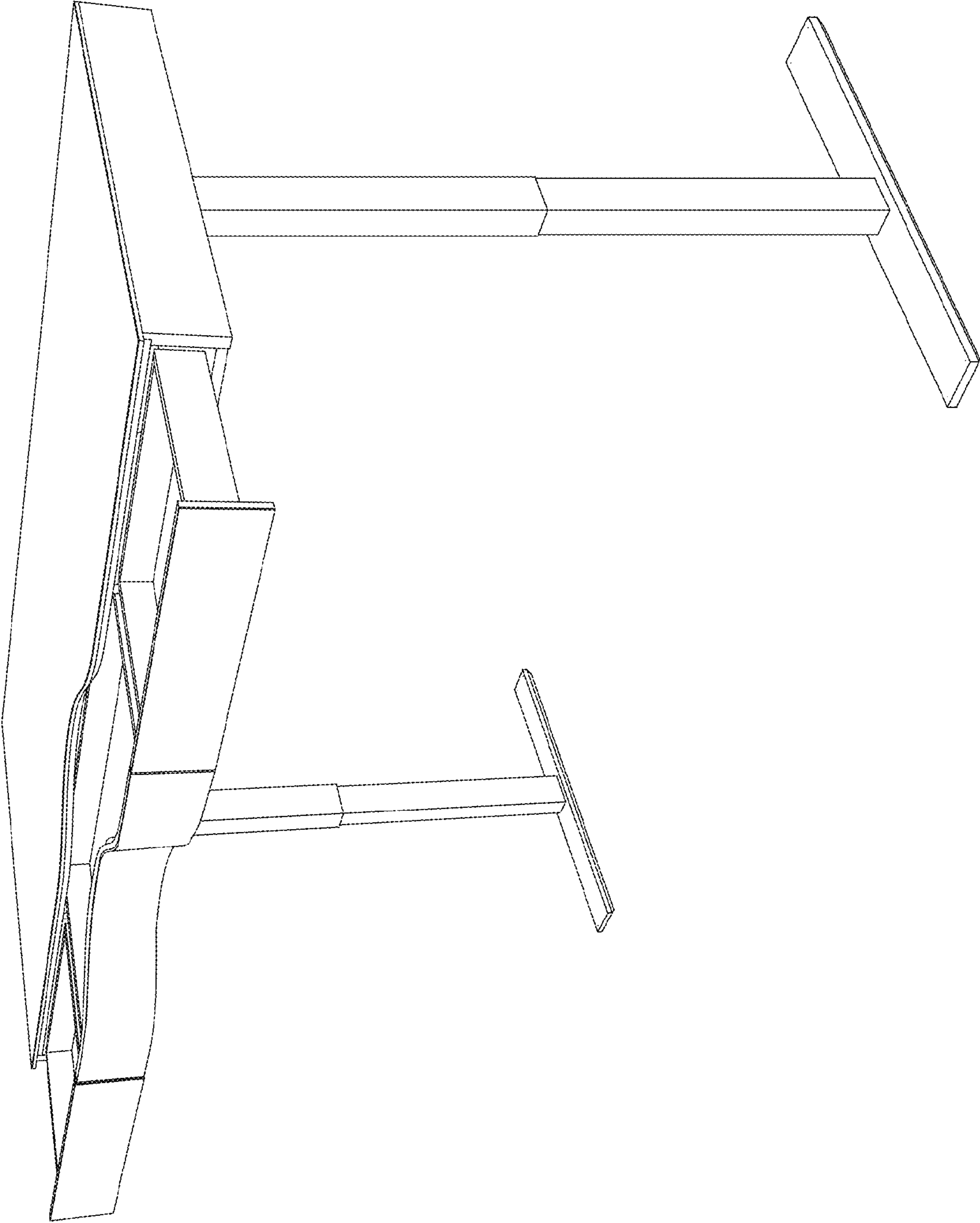

FIG. 15