



US00D871100S

(12) **United States Design Patent**
Trunsky

(10) **Patent No.:** **US D871,100 S**

(45) **Date of Patent:** **** Dec. 31, 2019**

(54) **PET RELIEF STATION**

D794,976 S * 8/2017 Fararji D6/518
D827,218 S * 8/2018 Van Wyk D30/153

(71) Applicant: **Crown Products, LLC**, Pompano Beach, FL (US)

* cited by examiner

(72) Inventor: **Jane C. Trunsky**, Pompano Beach, FL (US)

Primary Examiner — Wan Laymon

Assistant Examiner — Mark Booker

(73) Assignee: **Crown Products, LLC**, Pompano Beach, FL (US)

(74) *Attorney, Agent, or Firm* — William G. Giltinan; Eleanor M. Yost; Carlton Fields, PA

(**) Term: **15 Years**

(57) **CLAIM**

(21) Appl. No.: **29/637,849**

The ornamental design for a pet relief station, as shown and described.

(22) Filed: **Feb. 22, 2018**

(51) **LOC (12) Cl.** **20-02**

DESCRIPTION

(52) **U.S. Cl.**

USPC **D6/518**

(58) **Field of Classification Search**

USPC D6/518; D3/11, 17, 215, 217, 231, 327, D3/201, 203.1, 207; D30/108, 117, 119, D30/136, 137, 138, 139, 144, 145, 146, D30/151, 152, 153, 154, 158, 160, 161, D30/199; D25/12, 13, 14, 17-19, 31, 33; D9/432

CPC A01K 31/18; A01K 1/0245; A01K 1/0353; A01K 1/03; A01K 1/0254; A01K 1/0107; A01K 1/0114

See application file for complete search history.

FIG. 1 is a perspective view of the pet relief station showing the design.

FIG. 2 is a front elevational view thereof.

FIG. 3 is a rear elevational view thereof.

FIG. 4 is a left side elevational view thereof.

FIG. 5 is a right side elevational view thereof.

FIG. 6 is a top plan view thereof.

FIG. 7 is bottom plan view thereof.

FIG. 8 is a left side devotional view of an alternative embodiment of the design; and,

FIG. 9 is a right side elevational view of an alternative embodiment of the design.

The broken lines shown on the pet relief station are interior spaces viewable through cutouts and form no part of the claimed design. The remaining broken lines shown in the figures represent portions of the pet relief station that form no part of the claimed design.

(56) **References Cited**

U.S. PATENT DOCUMENTS

D524,994 S * 7/2006 Hamm D30/108
D640,837 S * 6/2011 Henley D30/108

1 Claim, 5 Drawing Sheets

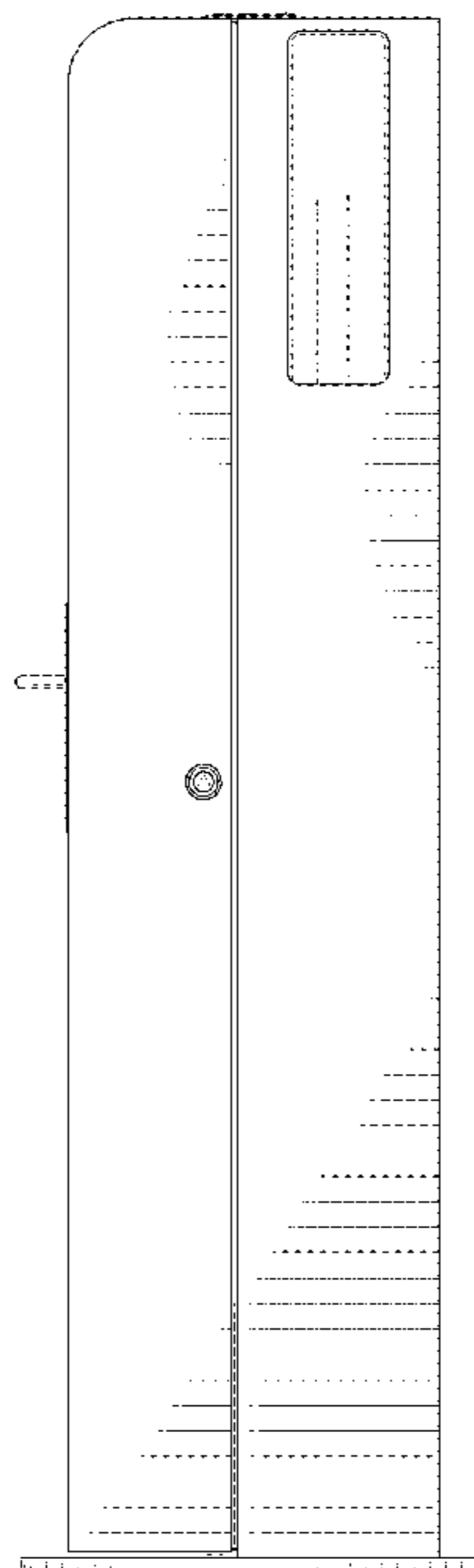
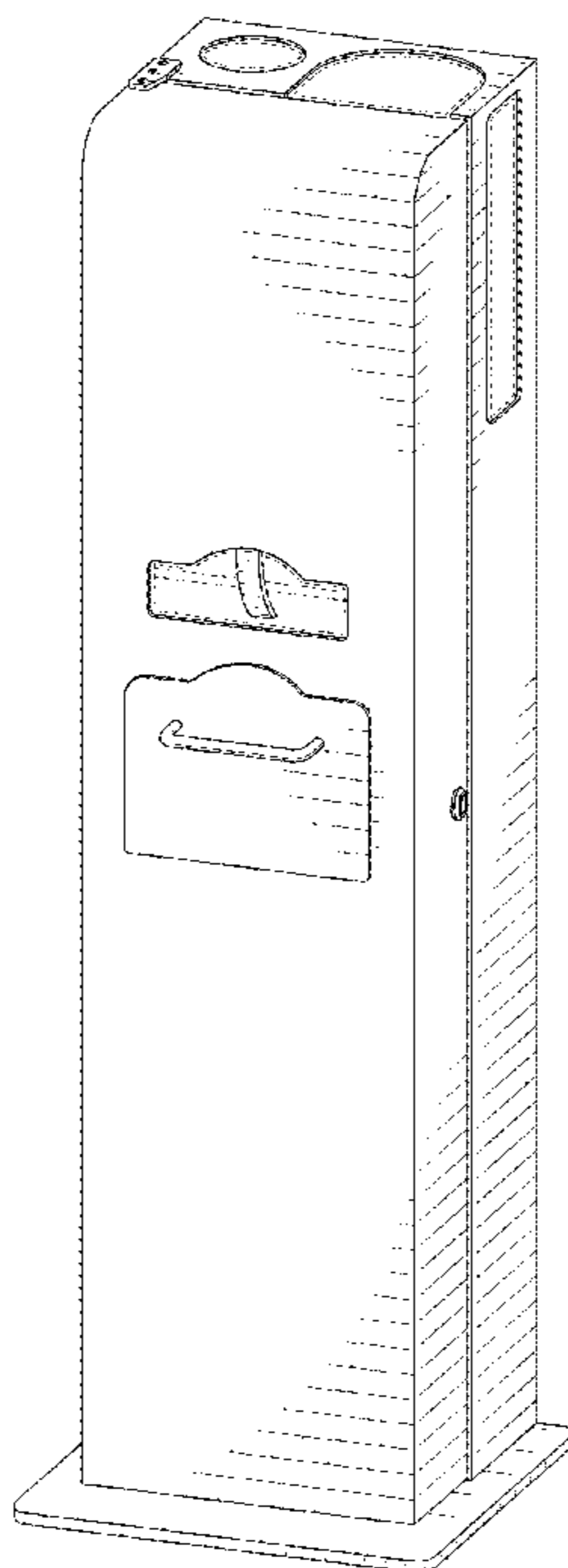

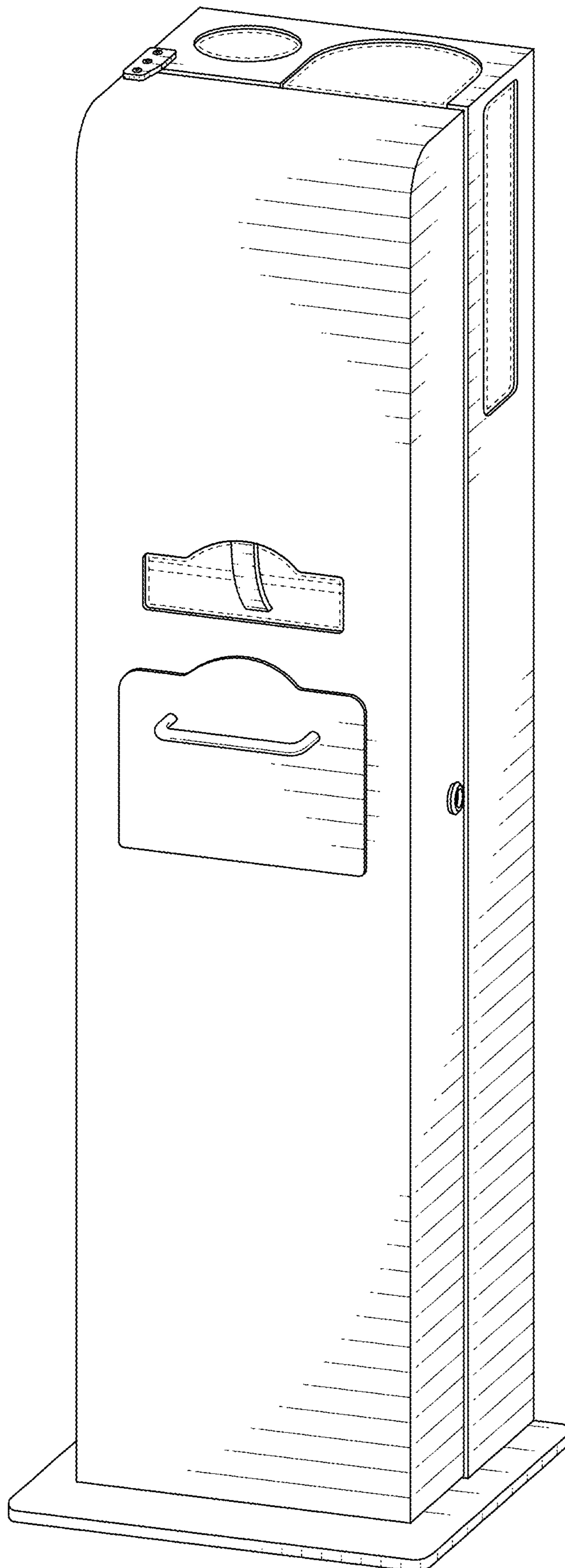

FIG. 1

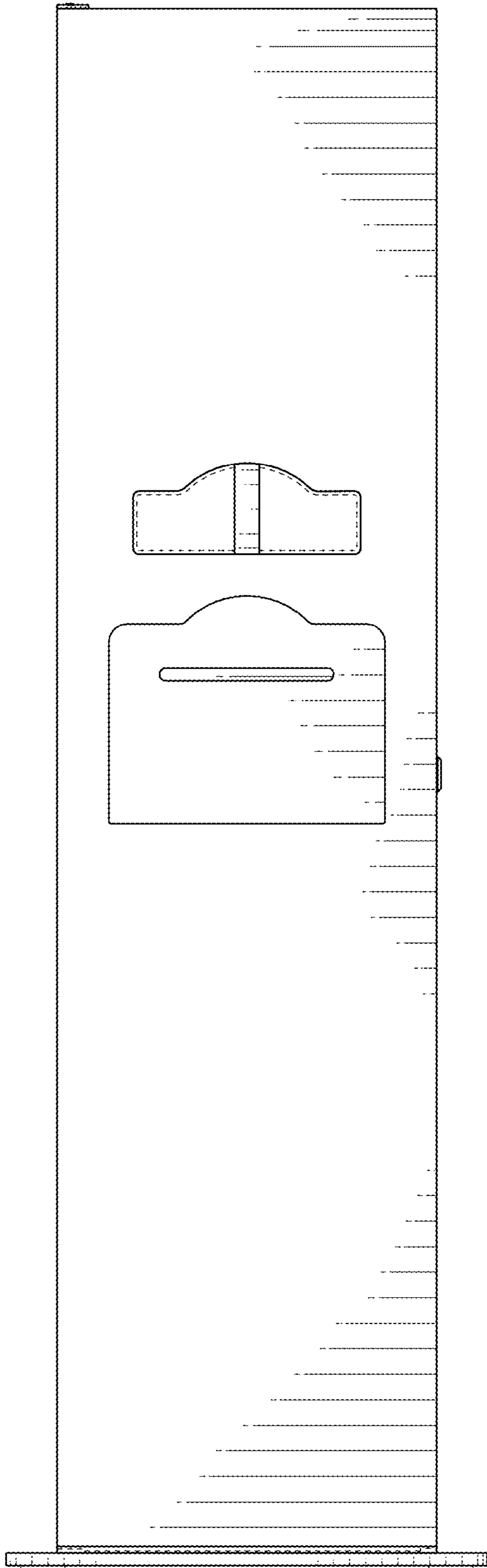

FIG. 2

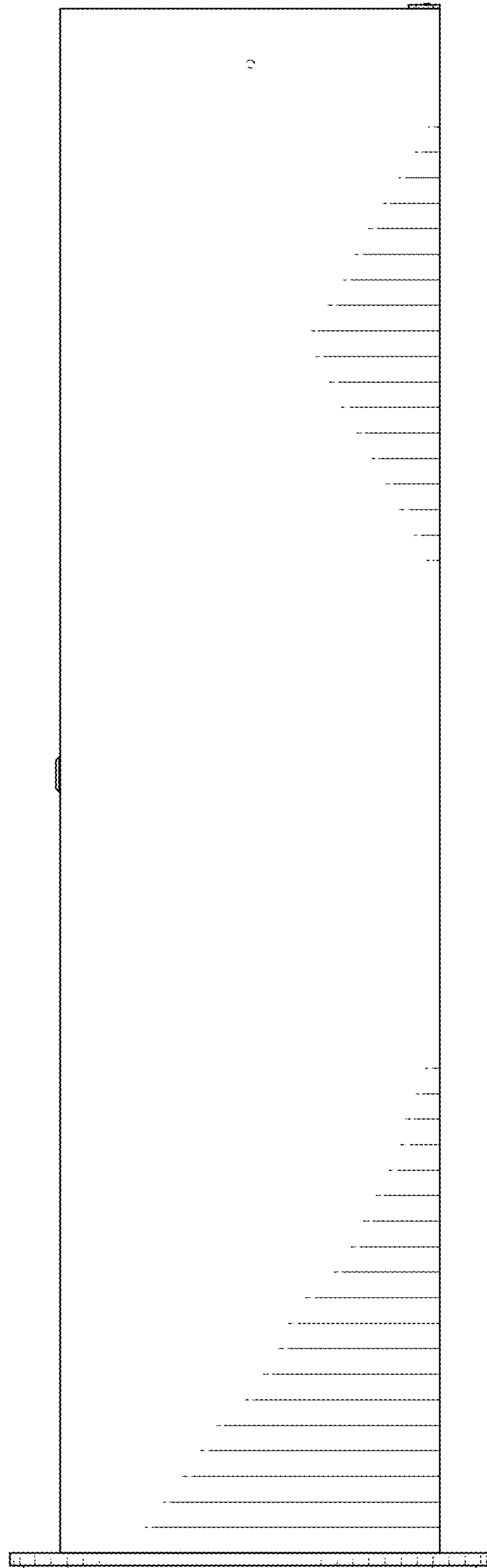

FIG. 3

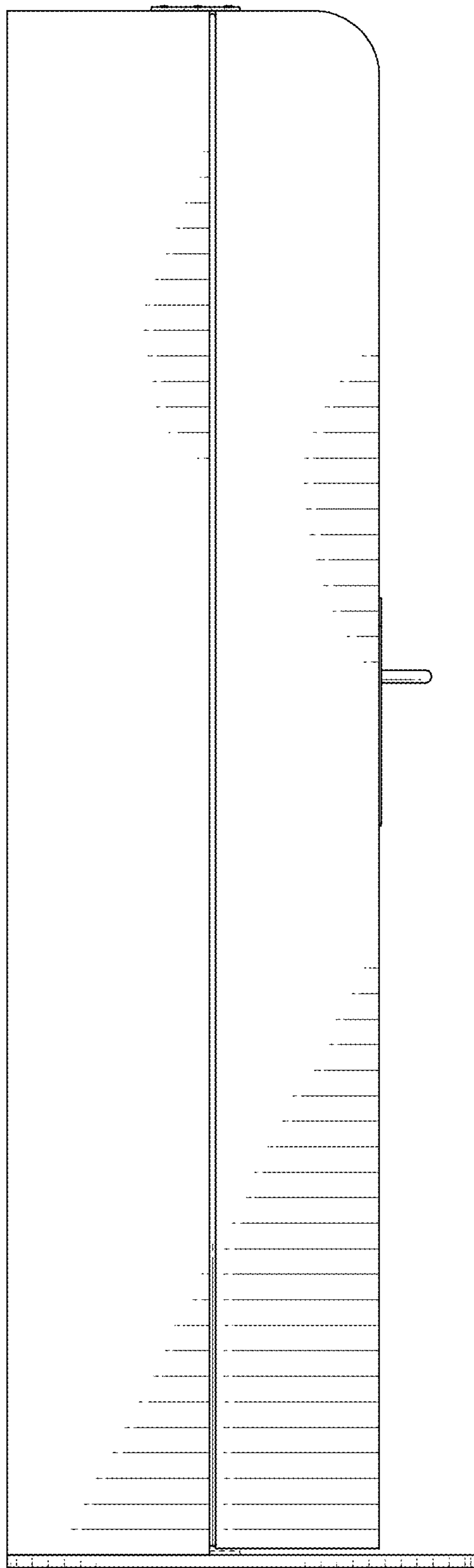

FIG. 4

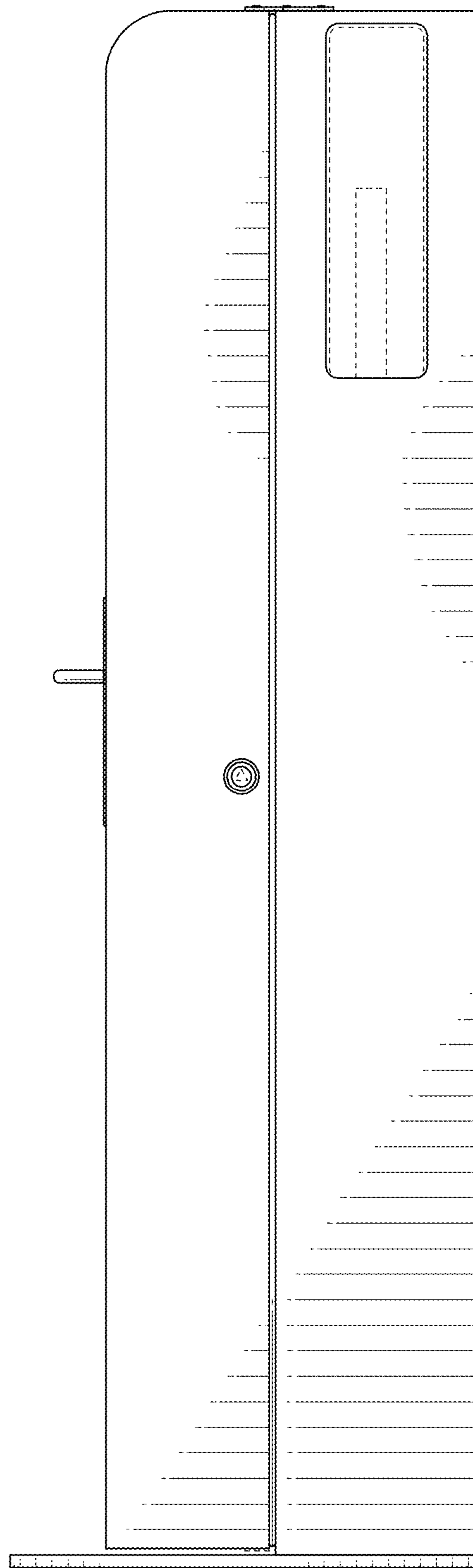

FIG. 5

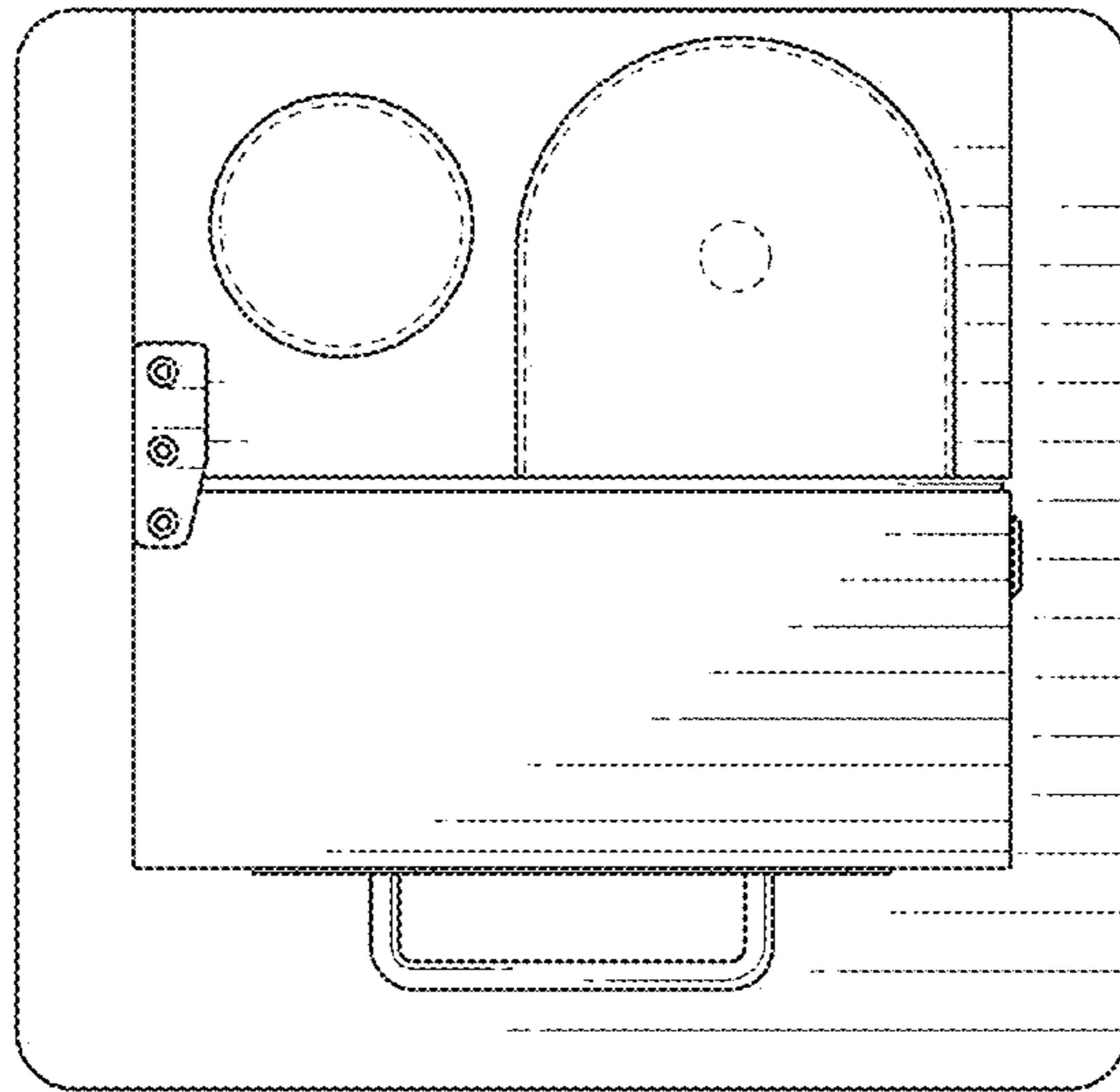

FIG. 6

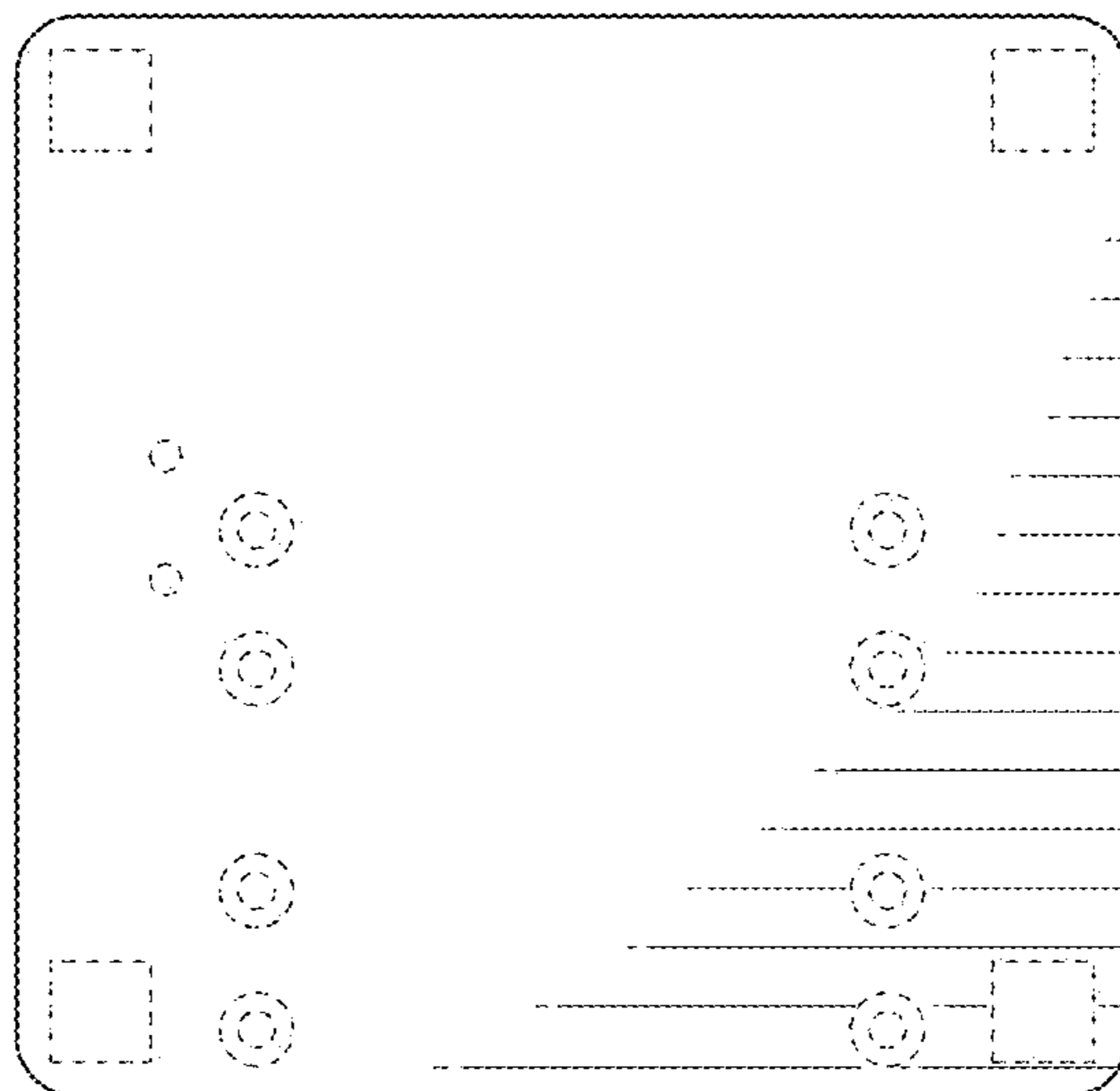

FIG. 7

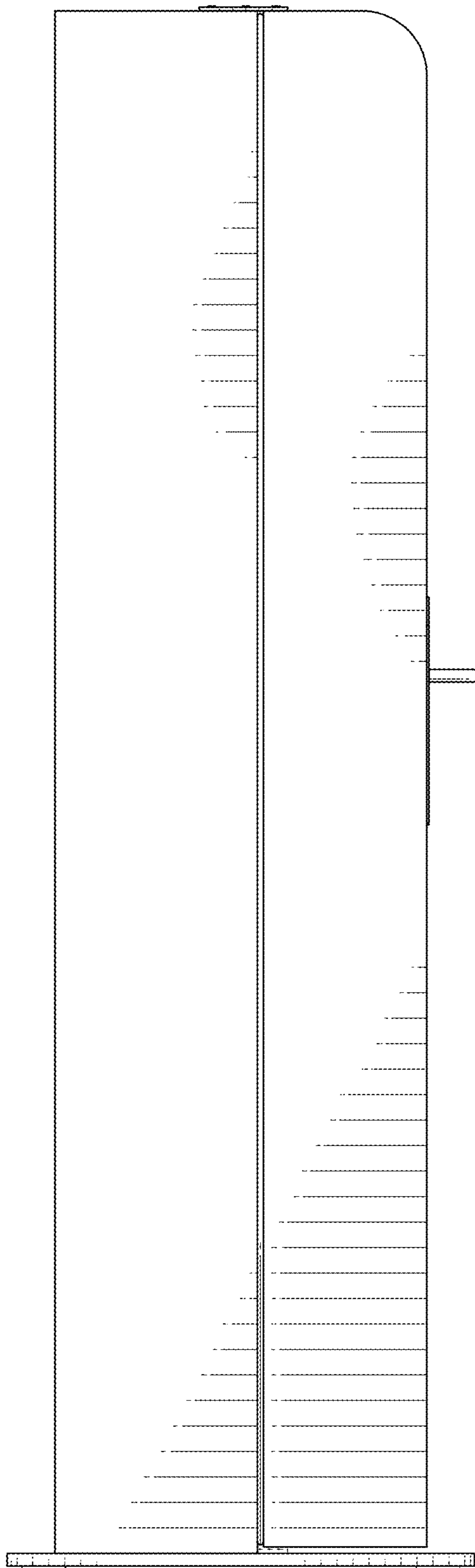

FIG. 8

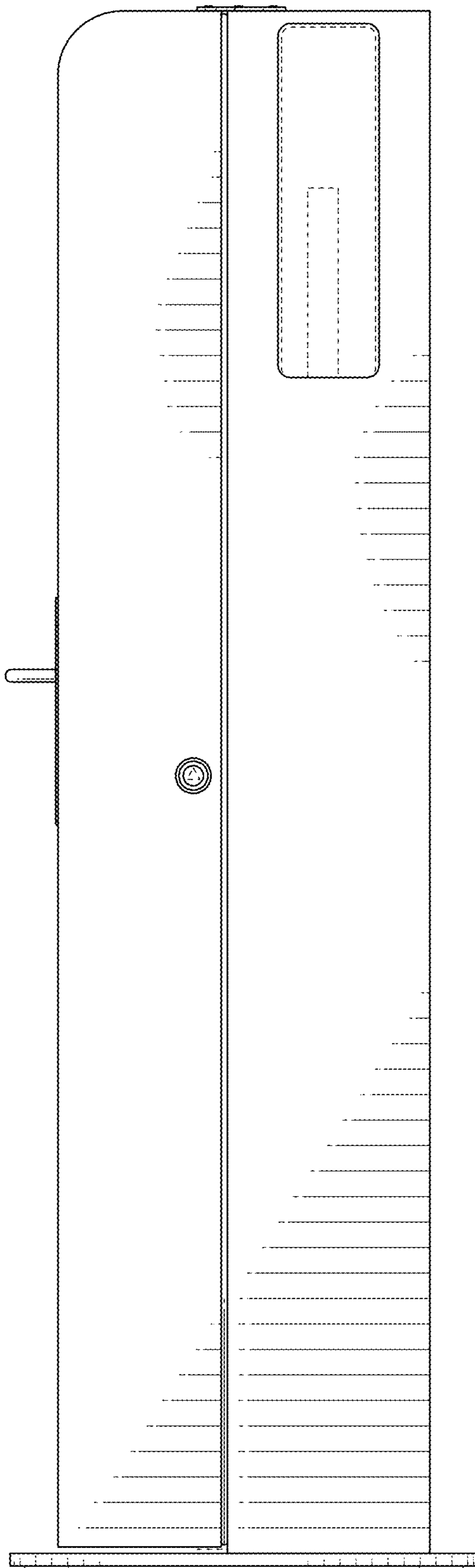

FIG. 9