

US00D871075S

(12) **United States Design Patent** (10) **Patent No.:** **US D871,075 S**  
**Cooke et al.** (45) **Date of Patent:** **\*\* Dec. 31, 2019**

(54) **HANDBAG HARDWARE**

(71) Applicant: **THE BIG O, LLC**, Dallas, TX (US)

(72) Inventors: **Jane Dunne Cooke**, Dallas, TX (US);  
**Mary Caroline Nix**, Dallas, TX (US)

(73) Assignee: **THE BIG O, LLC**, Dallas, TX (US)

(\*\*) Term: **15 Years**

(21) Appl. No.: **29/697,824**

(22) Filed: **Jul. 11, 2019**

**Related U.S. Application Data**

(63) Continuation of application No. 16/389,048, filed on Apr. 19, 2019, which is a continuation-in-part of application No. 29/632,809, filed on Jan. 10, 2018, now Pat. No. Des. 848,732, and a continuation-in-part of application No. 29/632,812, filed on Jan. 10, 2018, now Pat. No. Des. 847,497, and a continuation-in-part of application No. 29/666,944, filed on Oct. 17, 2018, now Pat. No. Des. 848,144, which is a continuation-in-part of application No. 29/632,809, filed on Jan. 10, 2018, now Pat. No. Des. 848,732, and a continuation-in-part of application No. 29/632,812, filed on Jan. 10, 2018, now Pat. No. Des. 847,497.

(51) **LOC (12) Cl.** ..... **03-01**

(52) **U.S. Cl.**  
USPC ..... **D3/318**

(58) **Field of Classification Search**  
USPC ..... D3/318, 232-233, 240-243, 245-246  
CPC .. A45C 11/00; A45C 3/06; A45C 1/02; A45C  
1/04; A45C 13/08; A45C 13/02; A45C  
1/024

See application file for complete search history.

(56) **References Cited**

U.S. PATENT DOCUMENTS

D107,719	S	*	12/1937	Felmann	.....	D3/246
4,934,528	A	*	6/1990	Miller	.....	A45C 1/02 206/235
D332,625	S	*	1/1993	LaPerche	.....	D19/121
D553,850	S	*	10/2007	Trower	.....	D3/208
D588,359	S	*	3/2009	Gonzalez	.....	D3/243
D607,636	S	*	1/2010	Chiu	.....	D3/208
D621,610	S		8/2010	Parsley et al.		
D693,117	S		11/2013	Maier		
D742,635	S		11/2015	Coleman		
D782,822	S	*	4/2017	Serrano	.....	D3/318
D811,732	S		3/2018	Barclay et al.		
D811,733	S		3/2018	Barclay et al.		
D826,550	S	*	8/2018	Filakousky	.....	D3/207
D847,497	S		5/2019	Cooke et al.		
D848,144	S		5/2019	Cooke et al.		
D848,732	S		5/2019	Nix et al.		

\* cited by examiner

*Primary Examiner* — Holly H Baynham

(74) *Attorney, Agent, or Firm* — Haynes and Boone, LLP

(57) **CLAIM**

The ornamental design for a handbag hardware, as shown and described.

**DESCRIPTION**

FIG. 1 is a perspective view of a handbag hardware showing our new design;  
FIG. 2 is a front elevational view thereof;  
FIG. 3 is a rear elevational view thereof;  
FIG. 4 is a right side elevational view thereof;  
FIG. 5 is a left side elevational view thereof;  
FIG. 6 is a top plan view thereof;  
FIG. 7 is a bottom plan view thereof;  
FIG. 8 is another perspective view thereof; and,  
FIG. 9 is yet another perspective view thereof.  
The broken lines shown in FIGS. 1-9 illustrate unclaimed portions of the handbag hardware and form no part of the claimed design.

**1 Claim, 7 Drawing Sheets**



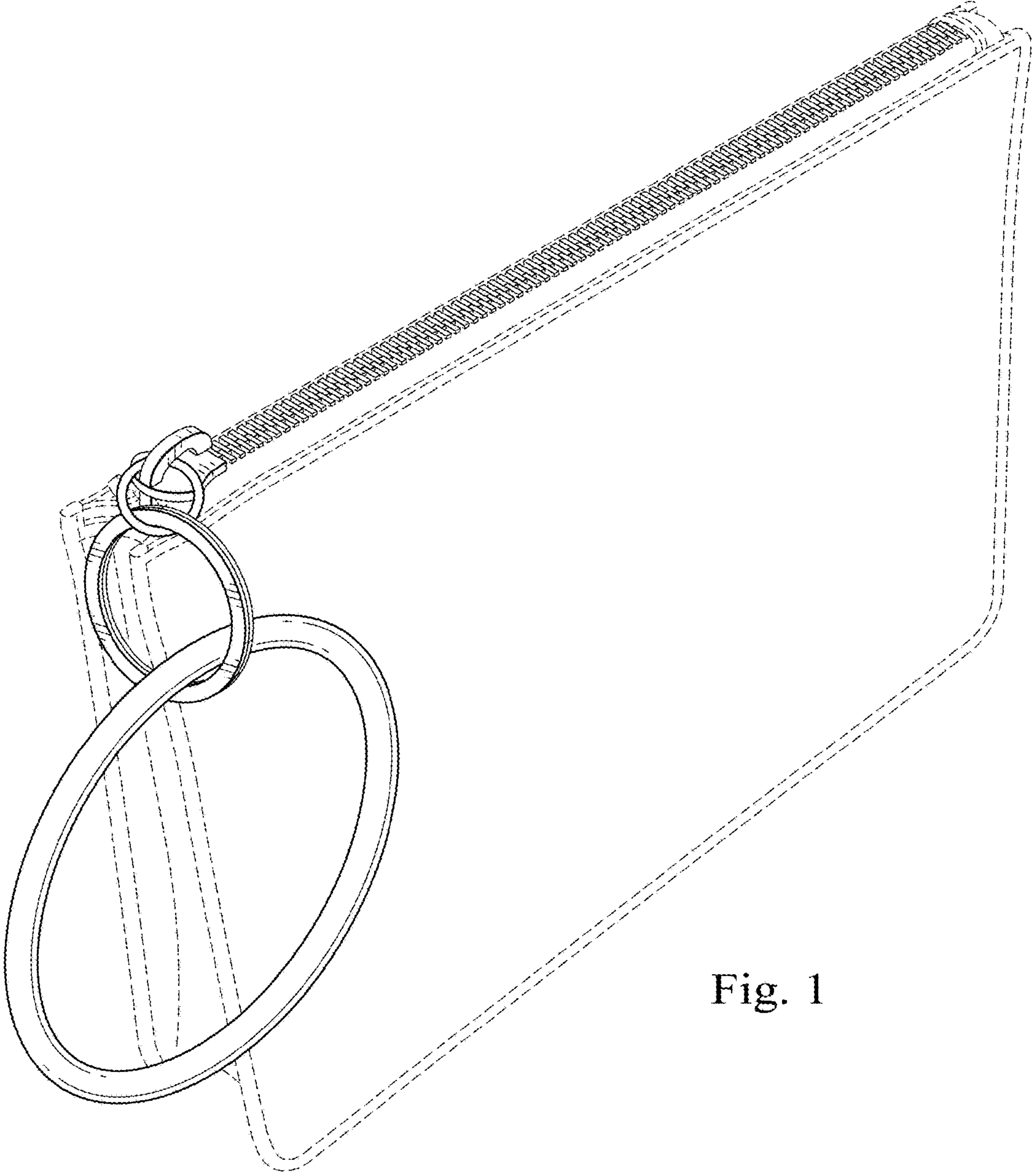

Fig. 1

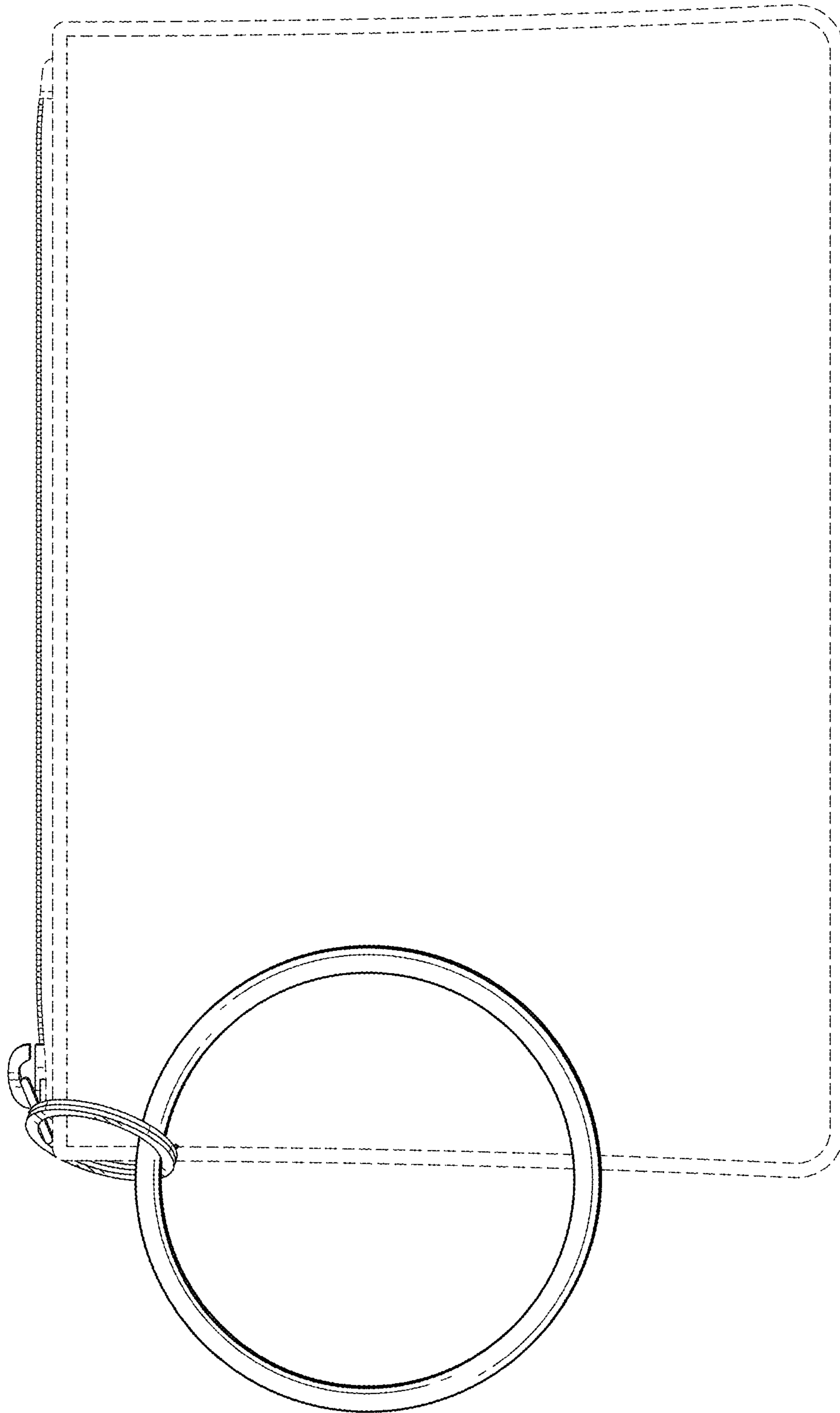

Fig. 2

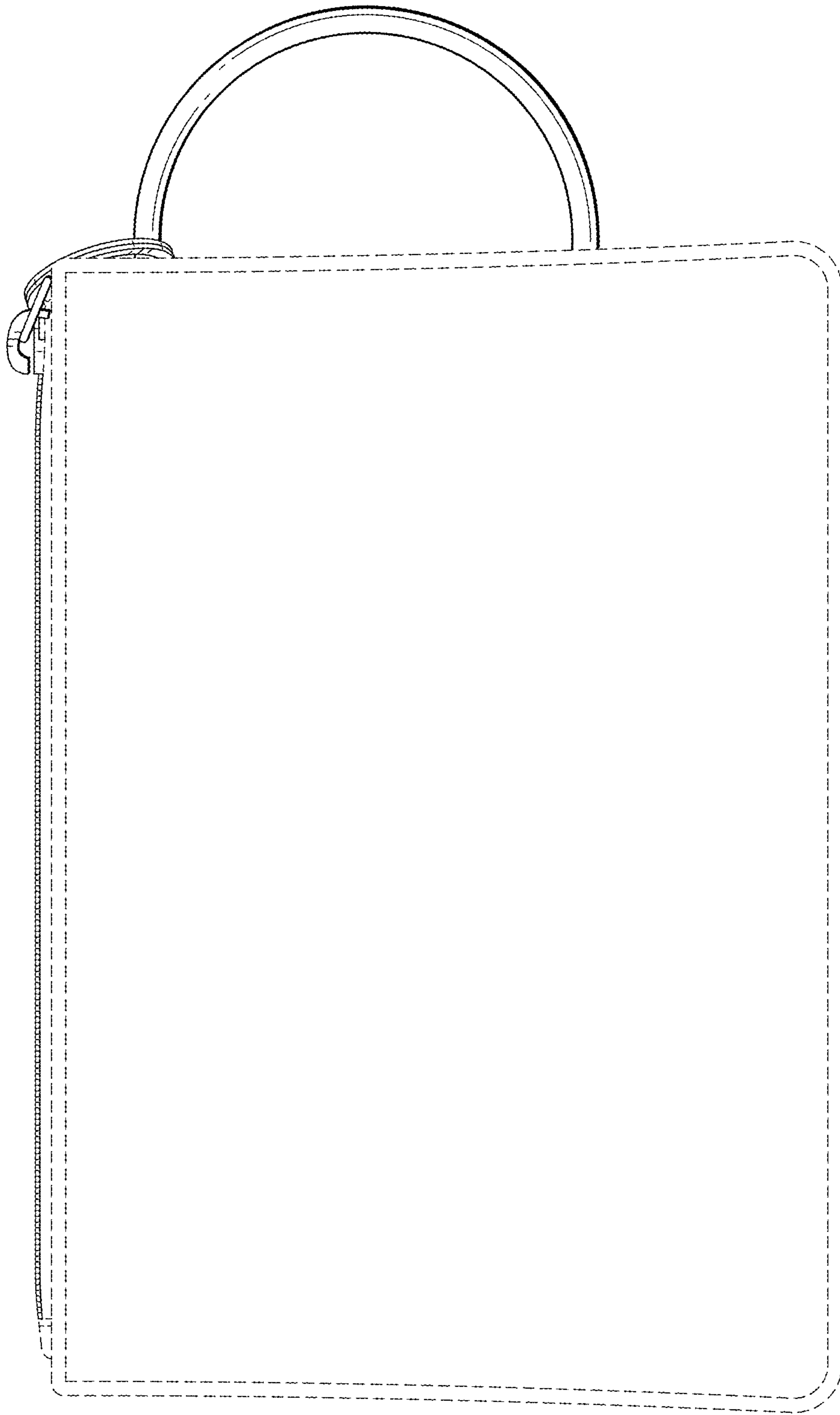

Fig. 3

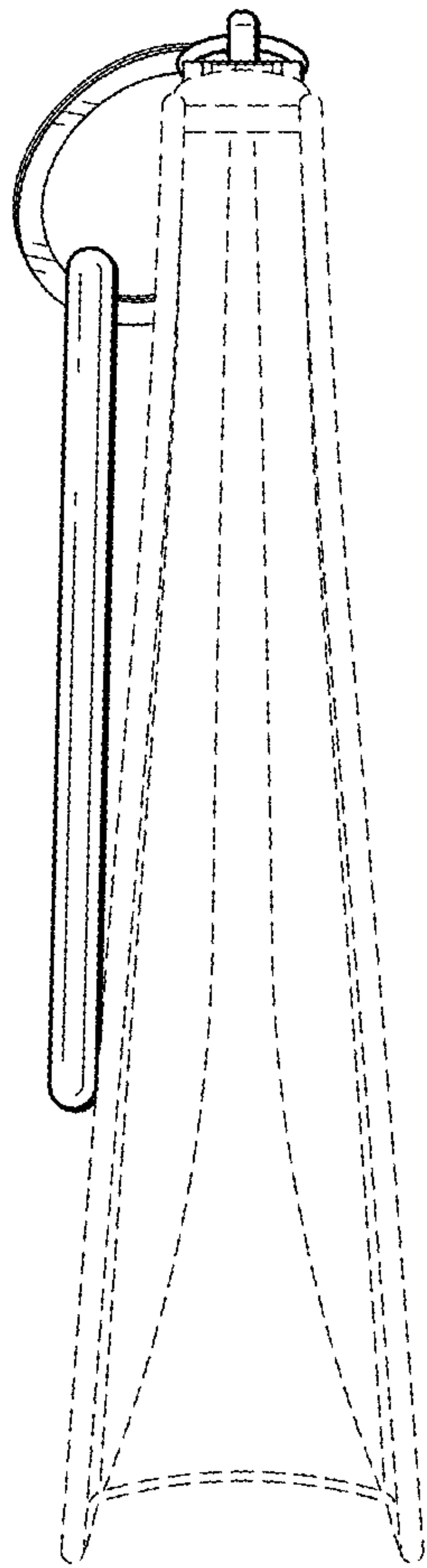

Fig. 4

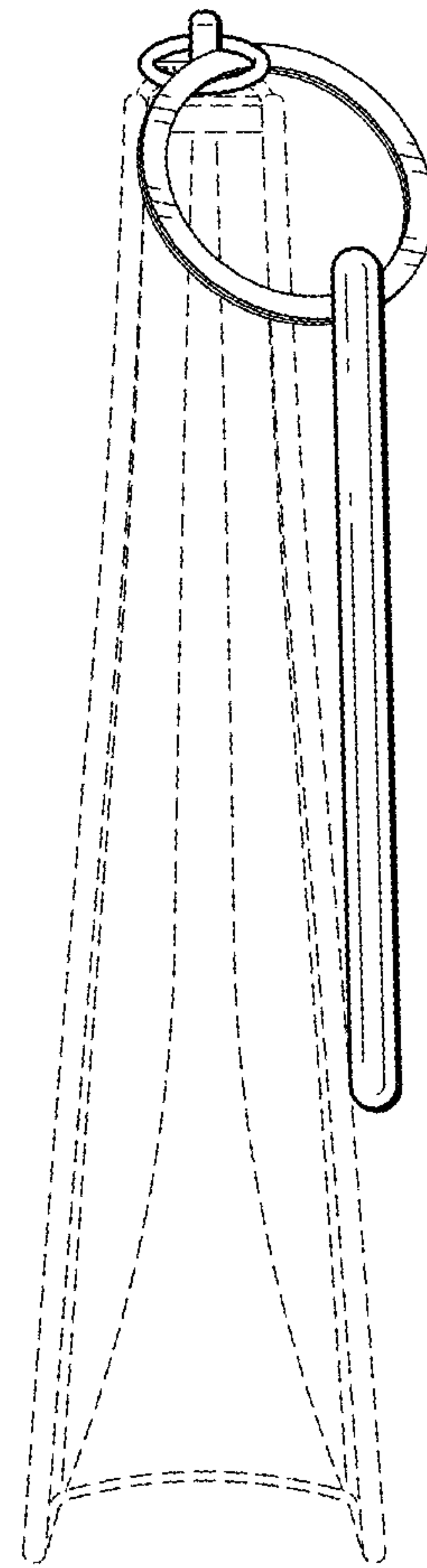

Fig. 5



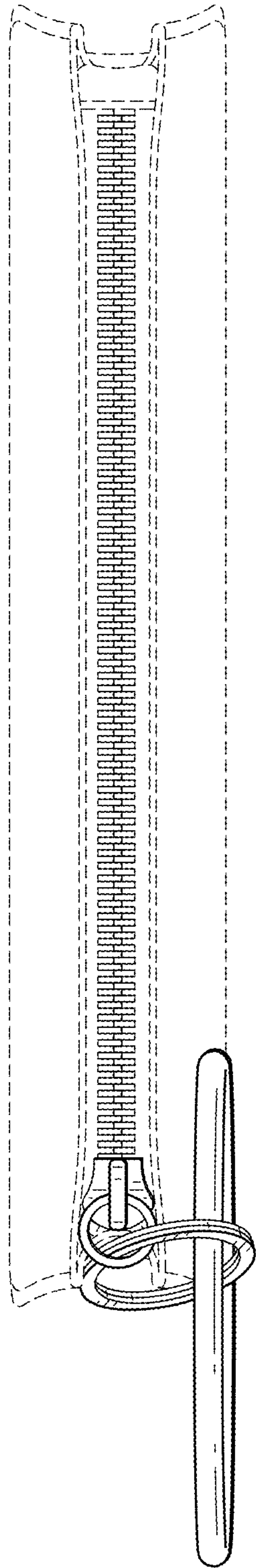

Fig. 6

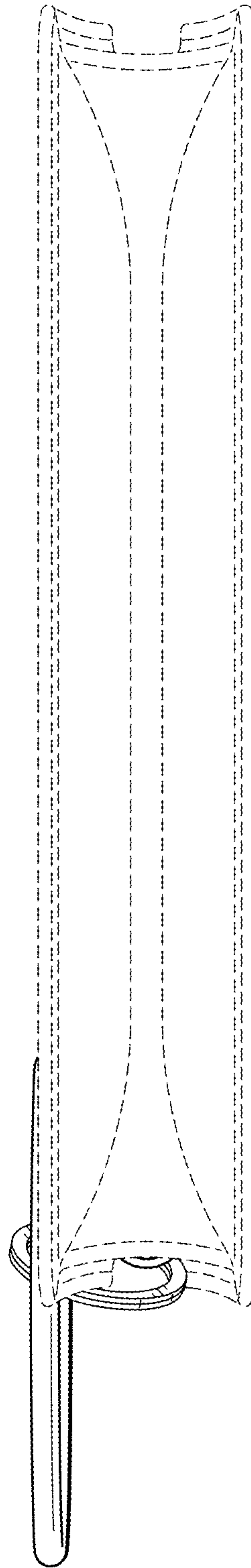

Fig. 7

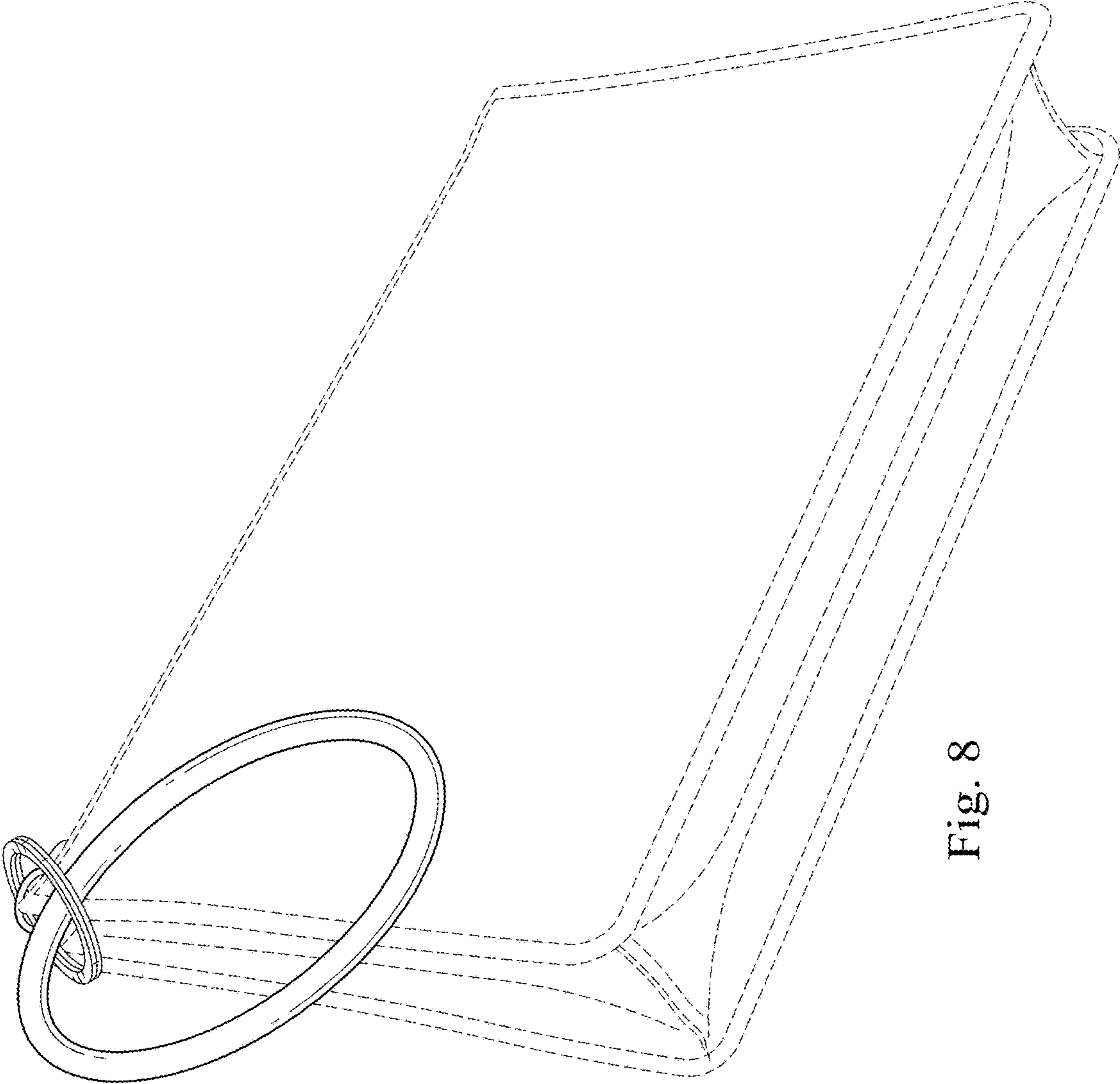

Fig. 8

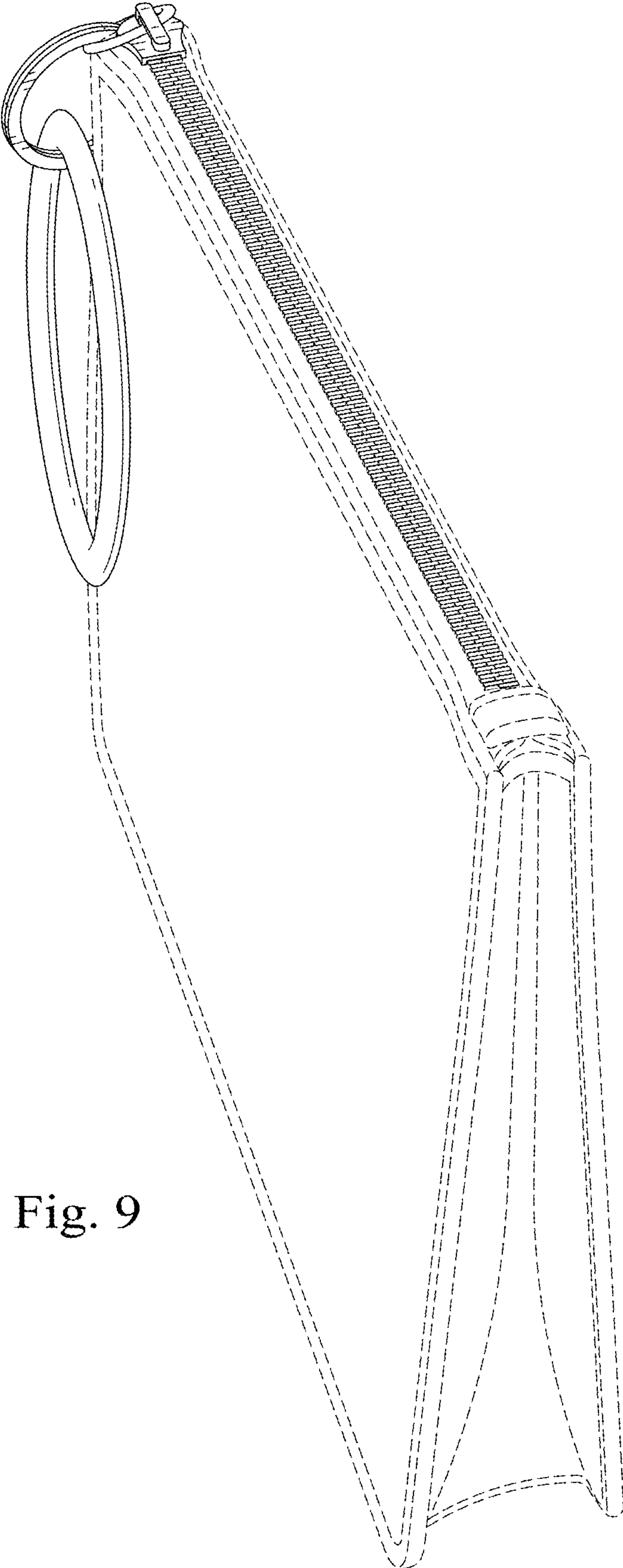

Fig. 9