



US00D870974S

(12) **United States Design Patent** (10) **Patent No.:** **US D870,974 S**  
**Cleij** (45) **Date of Patent:** **\*\* Dec. 24, 2019**

(54) **LIP BALM APPLICATOR**

(71) Applicant: **AIROSOLUTIONS NV**,  
Heist-op-den-Berg (BE)  
(72) Inventor: **Mervin Cleij**, Rotterdam (NL)  
(73) Assignee: **AIROSOLUTIONS NV**,  
Heist-op-den-Berg (BE)  
(\*\*) Term: **15 Years**

(21) Appl. No.: **29/624,179**

(22) Filed: **Oct. 30, 2017**

**Related U.S. Application Data**

(62) Division of application No. 35/501,448, filed on Jul. 27, 2016 (U.S. filing date under 35 U.S.C. 384), and having an international filing date of Jun. 23, 2016, now Pat. No. Des. 818,648.

(51) **LOC (12) Cl.** ..... **28-03**

(52) **U.S. Cl.**  
USPC ..... **D28/89**

(58) **Field of Classification Search**

USPC ..... D28/6, 7, 8.2, 77, 79, 85-90; D9/726, D9/503, 504, 770, 432, 424, 529, 428, D9/551, 539, 561, 684, 546, 559, 569, D9/553, 566, 519, 641, 542, 651, 560, D9/438, 449, 721, 724, 733, 425, 423, D9/600, 601, 502; D3/203.1, 203.2, D3/203.5, 203.6, 203.7, 203.8, 2, 273, D3/903, 207, 211, 270, 304, 279, 901, D3/205, 302, 294, 271.1, 257, 245, 202, D3/203.3, 203.4, 212; D23/366; D18/15, D18/16, 17; D19/108  
CPC ..... A45D 40/00; A45D 40/12; A45D 40/16; A45D 40/26; A45D 40/0012; A45D 40/0068; A61K 8/00; A61K 8/31; A61K 8/97; A61K 8/922; A61K 8/925; A61K 8/927

See application file for complete search history.

(56) **References Cited**

U.S. PATENT DOCUMENTS

D540,170 S	4/2007	Puigbo	
D554,529 S	11/2007	Green et al.	
D564,900 S	3/2008	Green et al.	
D582,580 S	12/2008	Spangler et al.	
D602,311 S	* 10/2009	Finell .....	D7/629
D605,364 S	12/2009	Lokken	
D631,204 S	1/2011	Dubitsky et al.	
D644,939 S	9/2011	Teller	
D650,280 S	* 12/2011	de Peyerimhoff .....	D9/454
D681,278 S	4/2013	Schlatter	
D708,789 S	* 7/2014	Schlatter .....	D28/87
D708,790 S	7/2014	Schlatter	
D708,791 S	7/2014	Schlatter	
D709,652 S	7/2014	Teller	
D710,544 S	8/2014	Shen	
D726,028 S	4/2015	Thompson	
D733,498 S	7/2015	Matharu	
D733,967 S	7/2015	Schlatter	

(Continued)

*Primary Examiner* — Zenia I Bennett

(74) *Attorney, Agent, or Firm* — Seed IP Law Group LLP

(57) **CLAIM**

The ornamental design for a lip balm applicator, substantially as shown and described.

**DESCRIPTION**

FIG. 1 is a front isometric view of a lip balm applicator, showing my new design.

FIG. 2 is a front elevational view thereof.

FIG. 3 is a rear elevational view thereof.

FIG. 4 is a left side elevational view thereof.

FIG. 5 is a right side elevational view thereof.

FIG. 6 is a top plan view thereof; and,

FIG. 7 is a bottom plan view thereof.

**1 Claim, 1 Drawing Sheet**

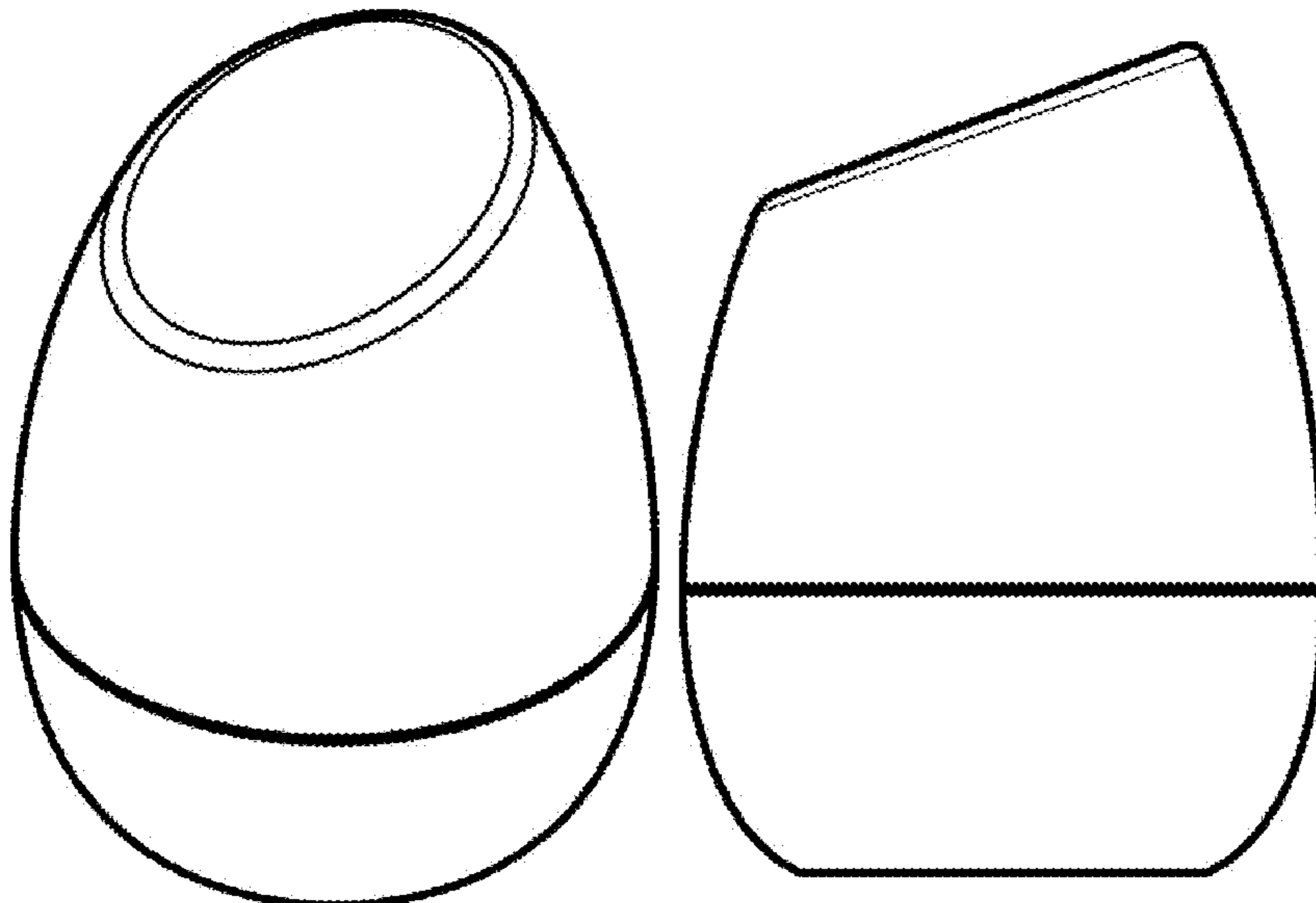

(56)

**References Cited**

U.S. PATENT DOCUMENTS

D734,550	S	7/2015	Schlatter	
D734,894	S	7/2015	Schlatter	
D735,039	S	7/2015	Pires et al.	
D735,414	S	7/2015	Schlatter	
D736,087	S	8/2015	Birgers	
D740,493	S	* 10/2015	David .....	D28/89
D742,593	S	11/2015	Corey et al.	
D765,512	S	9/2016	Joulia	
D768,336	S	10/2016	Schlatter et al.	
D768,936	S	10/2016	Yoshida	
D787,741	S	5/2017	Paquet	
D788,586	S	6/2017	Molinari	
D793,236	S	8/2017	Santos et al.	
D797,553	S	9/2017	Huang	
D803,060	S	11/2017	Marina et al.	
2011/0135377	A1	6/2011	Teller	
2016/0295993	A1	10/2016	Wojcik et al.	
2017/0325568	A1	11/2017	Teller et al.	

\* cited by examiner

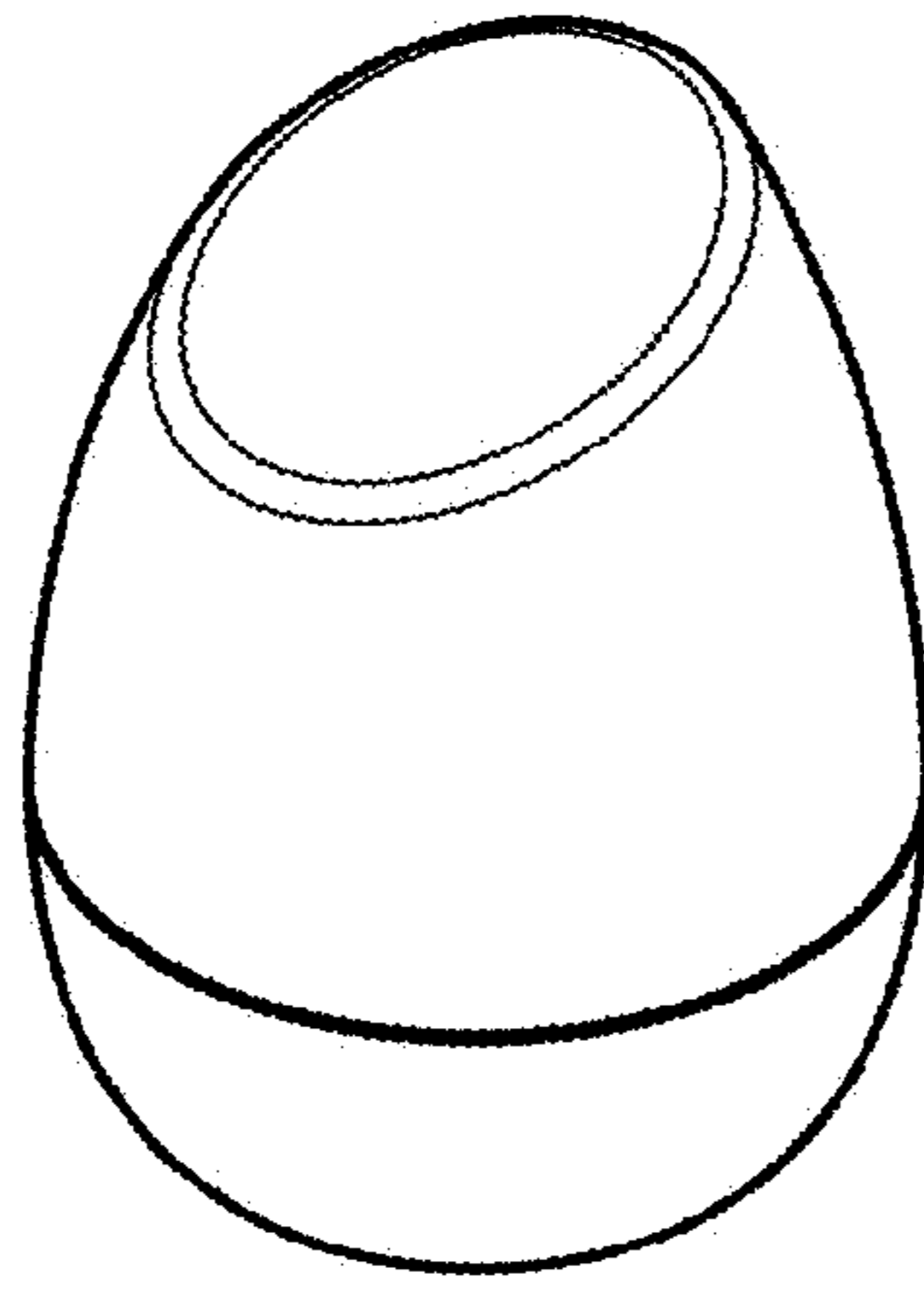

**FIG. 1**

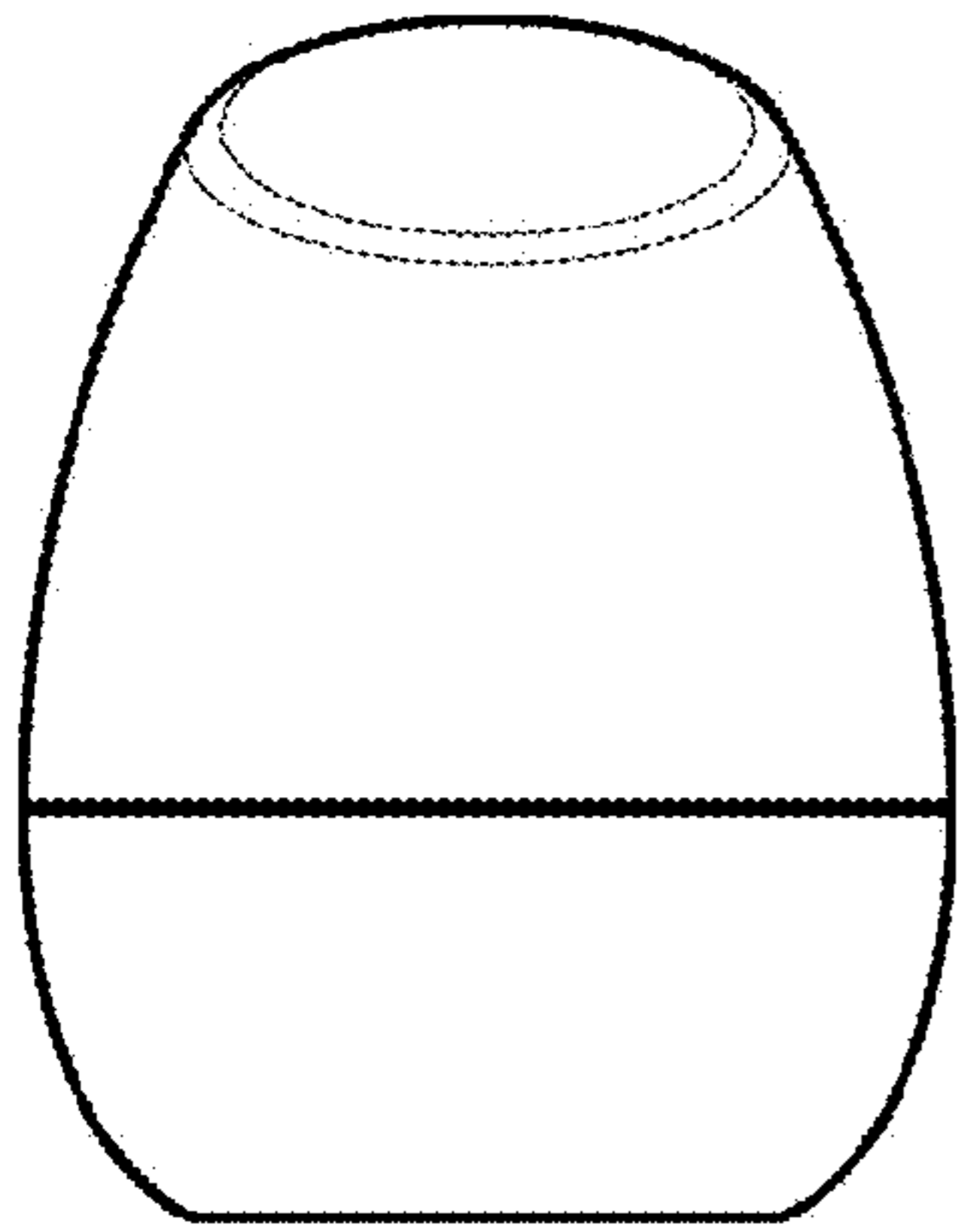

**FIG. 2**

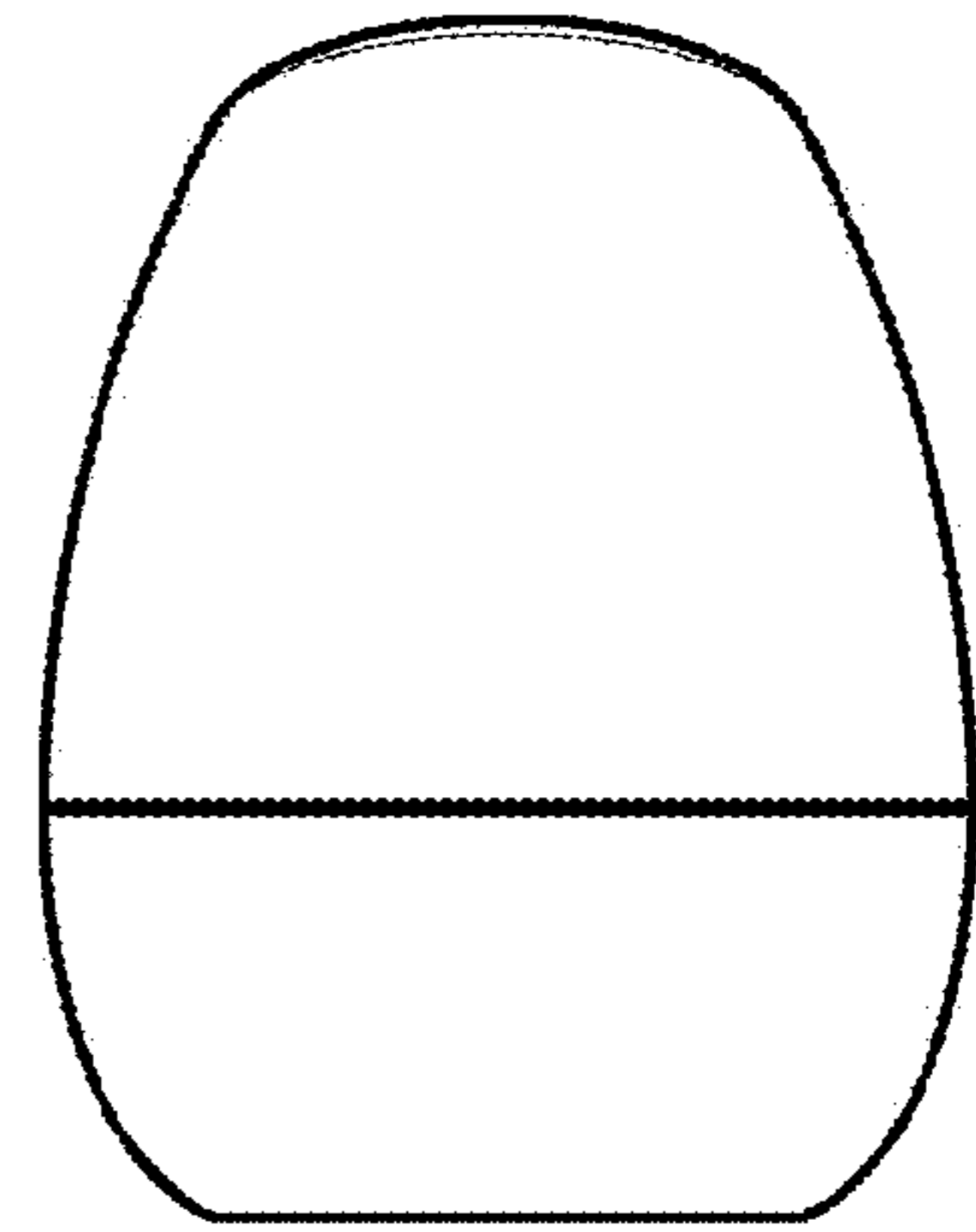

**FIG. 3**

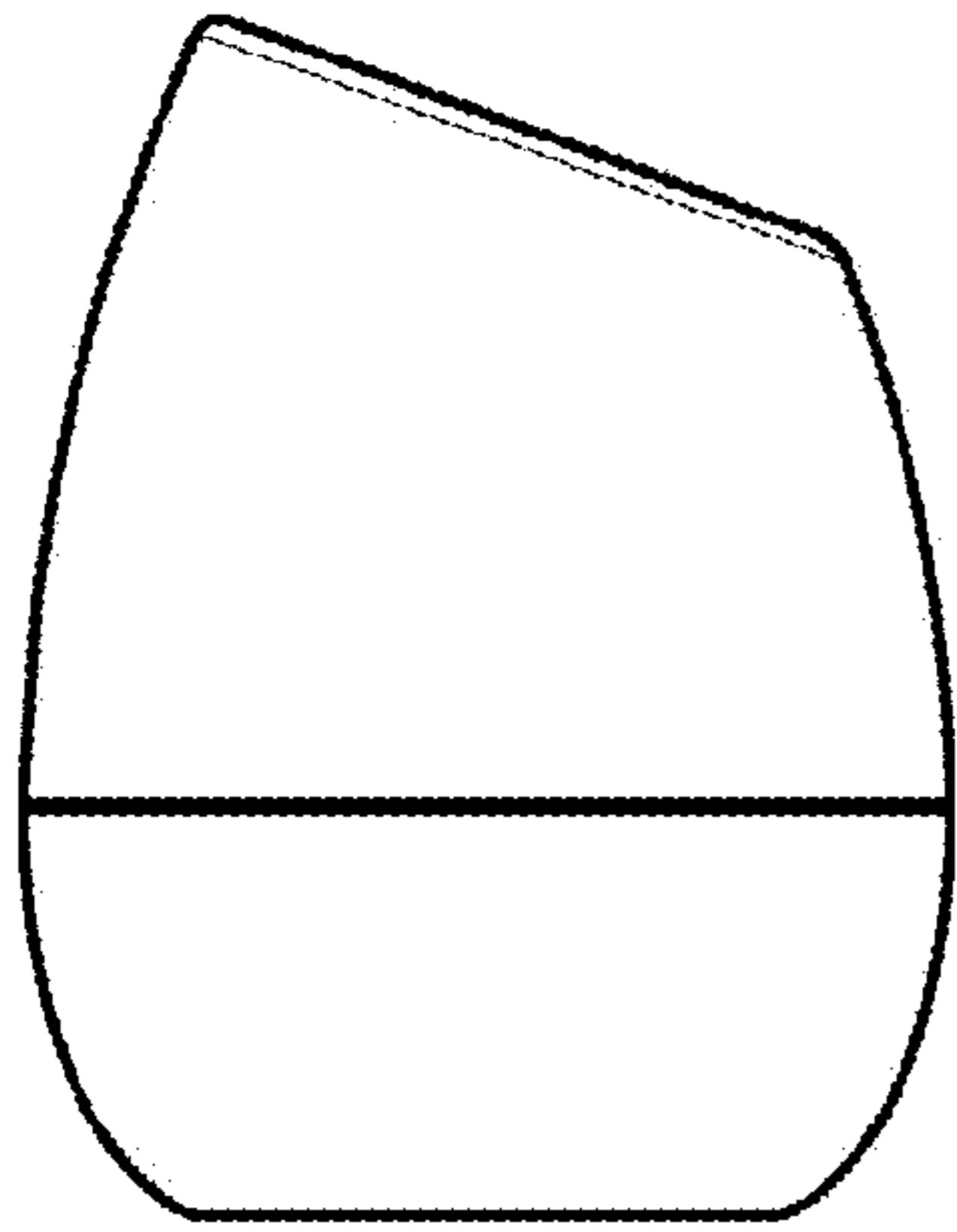

**FIG. 4**

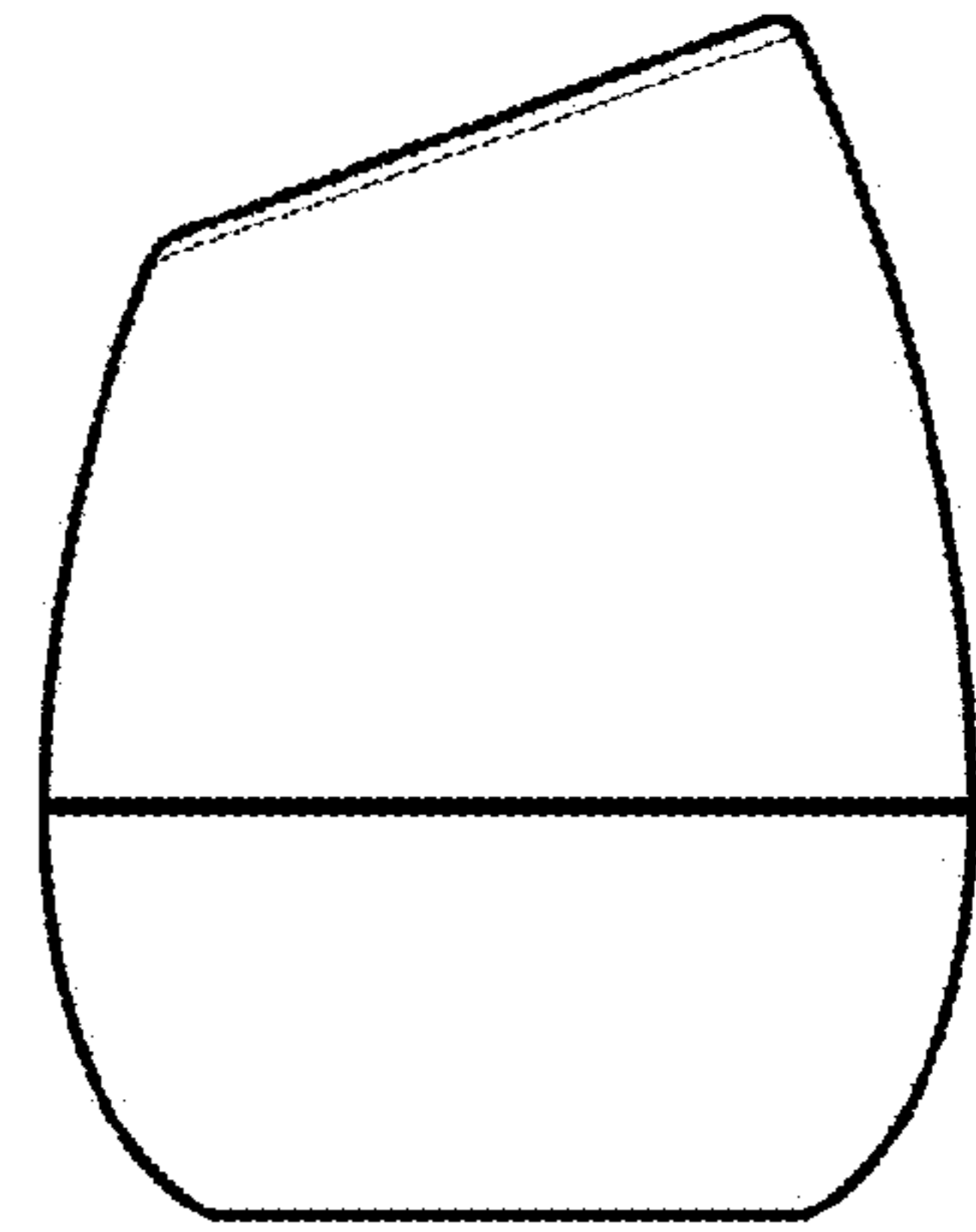

**FIG. 5**

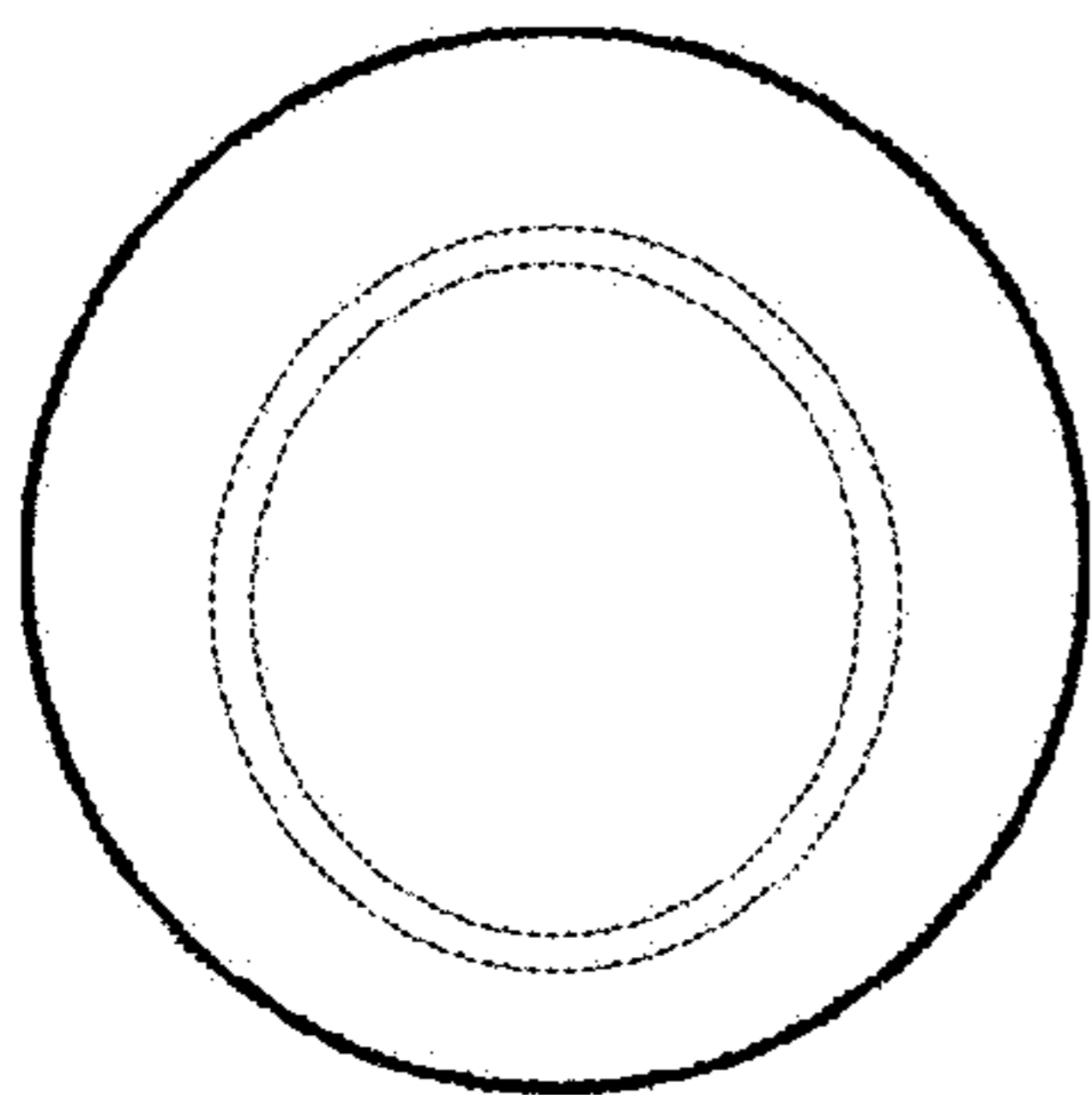

**FIG. 6**

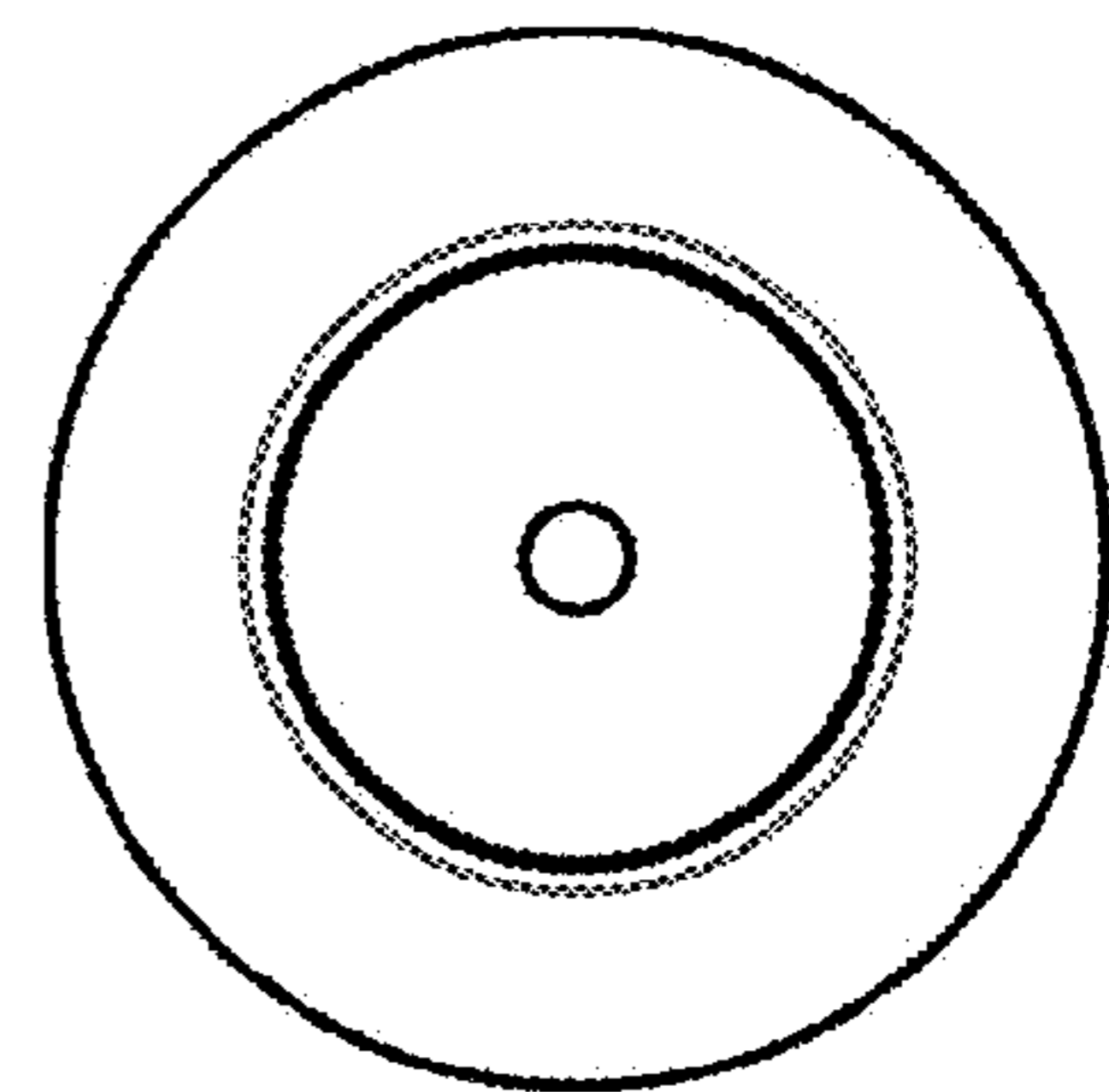

**FIG. 7**