



US00D870878S

(12) **United States Design Patent** (10) **Patent No.:** **US D870,878 S**
Wilson et al. (45) **Date of Patent:** **** Dec. 24, 2019**

(54) **NASAL CANNULA ASSEMBLY**
(71) Applicant: **Fisher & Paykel Healthcare Limited,**
Auckland (NZ)
(72) Inventors: **Daniel Charles Wilson,** Auckland
(NZ); **Chelsea Erin Johnson,** Auckland
(NZ); **Leon Tyler Stanley,** Auckland
(NZ); **Michael Paul Ronayne,**
Auckland (NZ); **Anna Rose Northey,**
Auckland (NZ)

3,513,844 A 5/1970 Smith
D228,692 S 10/1973 King
4,106,505 A 8/1978 Slater et al.
4,122,857 A 10/1978 Haerr
(Continued)

FOREIGN PATENT DOCUMENTS

CN 1905917 1/2007
CN 101396576 A 4/2009
(Continued)

OTHER PUBLICATIONS

Australian Government Patent Examination Report; dated Jul. 2,
2015; 4 pages.

(Continued)

Primary Examiner — Lilyana Bekic
(74) *Attorney, Agent, or Firm* — Knobbe, Martens, Olson
& Bear, LLP

(73) Assignee: **Fisher & Paykel Healthcare Limited,**
Auckland (NZ)
(**) Term: **15 Years**
(21) Appl. No.: **29/677,003**
(22) Filed: **Jan. 16, 2019**

Related U.S. Application Data

(62) Division of application No. 29/627,024, filed on Nov.
21, 2017, now Pat. No. Des. 849,242.
(51) **LOC (12) Cl.** **29-02**
(52) **U.S. Cl.**
USPC **D24/110.4; D24/110.5**
(58) **Field of Classification Search**
USPC D24/110.1–110.4, 110, 110.5–110.6, 112,
D24/127–128, 164; D21/660
CPC A61M 16/06; A61M 16/0683; A61M
16/0816; A61M 16/0875; A61M 16/208;
A61M 16/00; A61M 16/0666; A61M
16/0672; A61M 2202/0208; A62B 18/02;
A62B 18/10
See application file for complete search history.

(57) **CLAIM**

The ornamental design for a nasal cannula assembly, as
shown and described.

DESCRIPTION

FIG. 1 is a top, front and right side perspective view of a
nasal cannula assembly embodying our new design.
FIG. 2 is a top, rear and right side perspective view thereof.
FIG. 3 is a top view thereof.
FIG. 4 is a bottom view thereof.
FIG. 5 is a right side view thereof.
FIG. 6 is a left side view thereof.
FIG. 7 is a front view thereof; and,
FIG. 8 is a rear view thereof.

The broken lines in the drawings depict portions of the nasal
cannula assembly that form no part of the claimed design.

(56) **References Cited**
U.S. PATENT DOCUMENTS
2,807,262 A 12/1952 Lew
3,288,136 A 11/1966 Lund

1 Claim, 6 Drawing Sheets

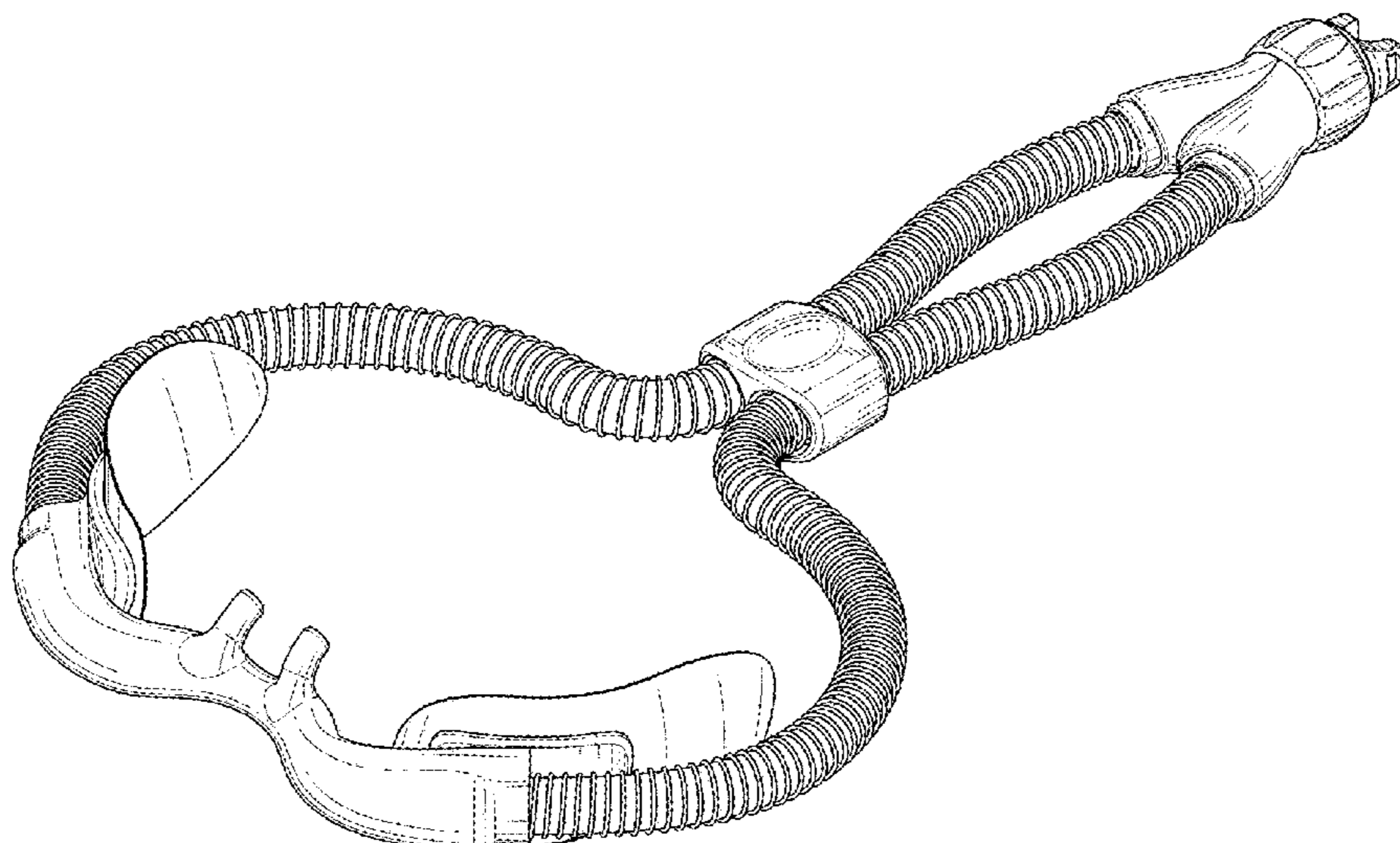

(56)

References Cited

U.S. PATENT DOCUMENTS

4,446,869 A 5/1984 Knodle
 4,584,997 A 4/1986 Delong
 4,589,684 A 5/1986 Nowacki et al.
 4,601,495 A 7/1986 Webb
 4,686,354 A 8/1987 Makin
 4,808,160 A 2/1989 Timmons et al.
 D300,271 S 3/1989 Rudolph et al.
 D300,272 S 3/1989 Rudolph et al.
 4,818,320 A 4/1989 Weichselbaum
 5,040,527 A 8/1991 Larson et al.
 5,163,914 A 11/1992 Abel
 5,292,312 A 3/1994 Delk et al.
 5,292,313 A 3/1994 Delk et al.
 5,300,037 A 4/1994 Delk et al.
 5,308,339 A 5/1994 Kalt et al.
 5,335,656 A 8/1994 Bowe et al.
 D363,541 S 10/1995 Cottone, Sr. et al.
 5,672,159 A 9/1997 Warrick
 5,682,881 A 11/1997 Winthrop et al.
 5,752,511 A 5/1998 Simmons et al.
 D431,634 S 10/2000 Mantz
 6,206,134 B1 3/2001 Stark
 6,328,038 B1 12/2001 Kessler et al.
 6,439,234 B1 8/2002 Curti et al.
 6,447,486 B1 9/2002 Tollini
 D468,015 S 12/2002 Horppu
 D472,316 S 3/2003 Douglas et al.
 6,536,428 B1 3/2003 Smith et al.
 D472,630 S 4/2003 Douglas et al.
 6,893,055 B2 5/2005 Thomas et al.
 6,915,705 B1 7/2005 Truitt
 D535,742 S 1/2007 VonDohlen et al.
 7,178,521 B2 2/2007 Burrow et al.
 D551,340 S 9/2007 Wood et al.
 7,331,348 B1 2/2008 Beevers
 7,353,826 B2 4/2008 Sleeper et al.
 7,370,652 B2 5/2008 Matula, Jr. et al.
 7,406,966 B2 8/2008 Wondka
 7,469,719 B2 12/2008 Gray
 D616,091 S 5/2010 Kyvik et al.
 D616,542 S 5/2010 Kyvik et al.
 D627,059 S 11/2010 Wood et al.
 D645,547 S 9/2011 Lombardi et al.
 D654,573 S 2/2012 Lombardi et al.
 D661,785 S 6/2012 Johnson
 D665,496 S 8/2012 Lee
 8,317,203 B2 11/2012 Hermle et al.
 D672,037 S 12/2012 Miller
 D678,510 S 3/2013 Koschany
 D681,193 S 4/2013 Thornbury et al.
 8,485,193 B2 7/2013 Worley
 8,534,278 B2 9/2013 Colman et al.
 D691,717 S 10/2013 McLean et al.
 D692,555 S 10/2013 Maksym et al.
 D695,890 S 12/2013 Bowden et al.
 D697,200 S 1/2014 Mahaffy
 D703,317 S 4/2014 Kinsey
 D717,946 S 11/2014 Kyvik et al.
 D724,720 S 3/2015 O'Connor et al.
 D735,326 S 7/2015 Gulliver
 D736,914 S 8/2015 Schultz
 D745,141 S 12/2015 Hung
 D747,471 S 1/2016 Gulliver
 D747,792 S 1/2016 Babbage et al.
 D755,962 S 5/2016 Adams
 D768,285 S 10/2016 Reed
 D789,527 S 6/2017 Kyvik et al.
 D794,184 S 8/2017 Smith
 D797,280 S 9/2017 Kyvik et al.
 9,808,612 B2 11/2017 Gulliver et al.
 D824,514 S 7/2018 Kyvik et al.
 D824,515 S 7/2018 Kyvik et al.
 D825,053 S 8/2018 Ronayne et al.
 D829,322 S 9/2018 Eury
 D849,242 S * 5/2019 Wilson D24/110.4

D849,243 S * 5/2019 Wilson D24/110.4
 10,279,142 B2 * 5/2019 Witt A61M 16/0666
 10,342,946 B2 * 7/2019 Matsubara A61M 16/0672
 2004/0090066 A1 5/2004 Hoffmann
 2004/0103686 A1 6/2004 Fehr et al.
 2004/0261797 A1 12/2004 White et al.
 2005/0028822 A1 2/2005 Sleeper et al.
 2005/0033247 A1 2/2005 Thompson
 2005/0178383 A1 8/2005 Mackie et al.
 2005/0199242 A1 9/2005 Matula et al.
 2006/0107958 A1 5/2006 Sleeper
 2006/0107960 A1 5/2006 Smart
 2007/0043334 A1 2/2007 Guala
 2007/0088327 A1 4/2007 Guala
 2007/0175473 A1 8/2007 Lewis et al.
 2008/0093846 A1 4/2008 Sparks et al.
 2008/0142019 A1 6/2008 Lewis et al.
 2008/0185007 A1 8/2008 Sleeper et al.
 2008/0190436 A1 8/2008 Jaffe et al.
 2008/0245369 A1 10/2008 Matula et al.
 2009/0078259 A1 3/2009 Kooij et al.
 2009/0101147 A1 4/2009 Landis et al.
 2009/0133699 A1 5/2009 Nalagatla et al.
 2009/0183739 A1 7/2009 Wondka
 2009/0223523 A1 9/2009 Chang
 2009/0299158 A1 12/2009 Boatner et al.
 2009/0320851 A1 12/2009 Selvarajan et al.
 2010/0000534 A1 1/2010 Kooij et al.
 2010/0018534 A1 1/2010 Veliss et al.
 2010/0057034 A1 3/2010 Dennis et al.
 2010/0100022 A1 4/2010 Greener et al.
 2010/0163051 A1 7/2010 Brewer et al.
 2010/0168600 A1 7/2010 Adriance et al.
 2010/0192957 A1 8/2010 Hobson et al.
 2010/0206310 A1 8/2010 Matsubara et al.
 2010/0224196 A1 9/2010 Jablons
 2010/0229872 A1 9/2010 Ho
 2011/0067704 A1 3/2011 Kooji et al.
 2012/0132209 A1 5/2012 Rummery et al.
 2012/0167894 A1 7/2012 O'Leary
 2013/0037030 A1 2/2013 Matula
 2013/0104888 A1 5/2013 Landis et al.
 2013/0298912 A1 11/2013 Gulliver et al.
 2014/0000626 A1 1/2014 O'Connor et al.
 2014/0014108 A1 1/2014 Dillard
 2014/0053846 A1 2/2014 Wood
 2014/0200475 A1 7/2014 Rubin
 2014/0338669 A1 11/2014 Zhao et al.
 2015/0021909 A1 1/2015 Gulliver et al.
 2015/0090255 A1 4/2015 Gulliver et al.
 2015/0320962 A1 11/2015 Baffle et al.
 2016/0030696 A1 2/2016 Klenner et al.
 2016/0051787 A1 2/2016 Matsubara et al.
 2016/0131292 A1 5/2016 Decker
 2016/0158476 A1 6/2016 Tatkov
 2016/0175548 A1 6/2016 Spence et al.
 2016/0235937 A1 8/2016 Ronayne et al.
 2017/0065789 A1 3/2017 Reed
 2017/0348500 A1 12/2017 Johnson et al.
 2018/0043124 A1 2/2018 Ronayne et al.
 2018/0078727 A1 3/2018 Johnson et al.
 2019/0099570 A1 * 4/2019 Brambilla A61M 16/0096
 2019/0134334 A1 * 5/2019 Kwok A61M 16/06

FOREIGN PATENT DOCUMENTS

CN 101653632 2/2010
 CN 101977656 2/2011
 DE 37 09 122 A1 9/1988
 DE 10 2007 063 556 A1 7/2009
 EP 806217 A2 11/1997
 EP 1 314 446 8/2002
 EP 1481702 12/2004
 FR 2363423 A1 3/1978
 GB 813700 A 5/1959
 GB 836407 A 6/1960
 GB 933172 A 8/1963
 GB 2368800 5/2002
 GB 2436525 10/2007

(56)

References Cited

FOREIGN PATENT DOCUMENTS

JP	H09-510635	10/1997
JP	2000-500359	1/2000
JP	2003-502116	1/2003
JP	2005-40589	2/2005
JP	2009-72596	4/2009
JP	2009-291615	12/2009
WO	WO 1992/20392	11/1992
WO	WO 1998/044973	10/1998
WO	WO 2003/082406	10/2003
WO	WO 2004/108218	12/2004
WO	WO 2005/079670	9/2005
WO	WO 2008/019294	2/2008
WO	WO 2008/100860	8/2008
WO	WO 2012/091967	7/2012
WO	WO 2013/014581	1/2013
WO	WO 2013/022356	2/2013
WO	WO 2013/157960	10/2013

OTHER PUBLICATIONS

Australian Examination Report; dated Jan. 19, 2017; 4 pages.
 Chinese Exam Report, CN 201480069093.1; dated Jun. 28, 2017; 10 pages.
 Chinese Office Action; dated Nov. 4, 2015; 8 pages.
 Extended European Search Report, EP 1485791.2; dated May 15, 2017; 7 pages.
 GB Examination Report; dated Jun. 2, 2016; 2 pages.
 GB Examination Report; dated May 18, 2016; 2 pages.
 GB Examination Report; dated May 19, 2016; 1 page.
 International Search Report and Written Opinion, PCT/NZ2011/000218; dated Feb. 27, 2012; 17 pages.

International Search Report and Written Opinion, PCT/NZ2012/000142; dated Jan. 22, 2013; 14 pages.
 International Preliminary Report on Patentability, PCT/NZ2014/000217; dated Jan. 12, 2015; 21 pages.
 International Preliminary Report on Patentability, PCT/NZ2012/000142; dated Feb. 20, 2014; 6 pages.
 Japanese Examination Report and English translation; dated Aug. 19, 2015; 4 pages.
 Japanese Examination Report, JP 2014524961A; dated Nov. 8, 2017; 2 pages.
 TW Search Report; English Translation; dated May 18, 2016; 1 page.
 UK Examination Report; GB15162878; dated Oct. 8, 2015; 8 pages.
 UK Examination Report; GB15162852; dated Oct. 8, 2015; 7 pages.
 UK Examination Report; GB15225840; dated Feb. 4, 2016; 8 pages.
 UK Examination Report; GB15162878; dated Feb. 4, 2016; 5 pages.
 UK Examination Report; GB15162852; dated Feb. 4, 2016; 5 pages.
 UK Examination Report; GB15225832; dated Feb. 4, 2016; 5 pages.
 UK Examination Report; GB13066352; dated Feb. 4, 2016; 3 pages.
 UK Examination Report; GB16031130; dated Mar. 4, 2016; 7 pages.
 UK Examination Report; GB16032922; dated Mar. 11, 2016; 6 pages.
 AU Examination Report; 2011318681; dated Apr. 12, 2016; 3 pages.
 Optiflow Junior: Easy Care, Effective Flow. Fisher & Paykel. Brochure. Date Published: 2012 (Year: 2012).
 Optiflow Junior 2. Fisher & Paykel Healthcare. Web archive date: Jun. 26, 2018. Retrieved from Internet: <https://web.archive.org/.../1001/https://www.fphcare.com/us/hospital/infant-respiratory/nasal-high-flow-therapy/understand/optiflow-junior-2/> (Year: 2018).

* cited by examiner

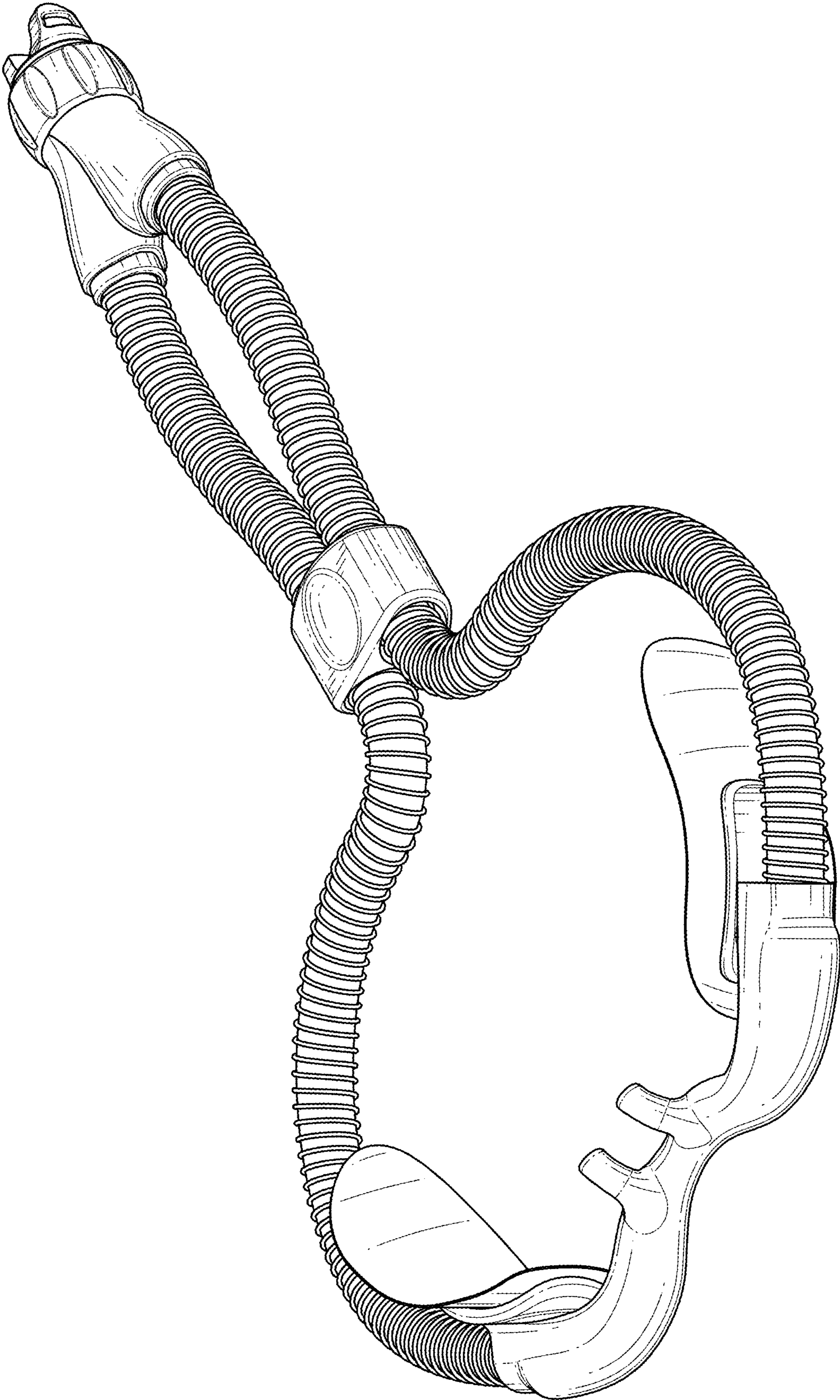

FIG. 1

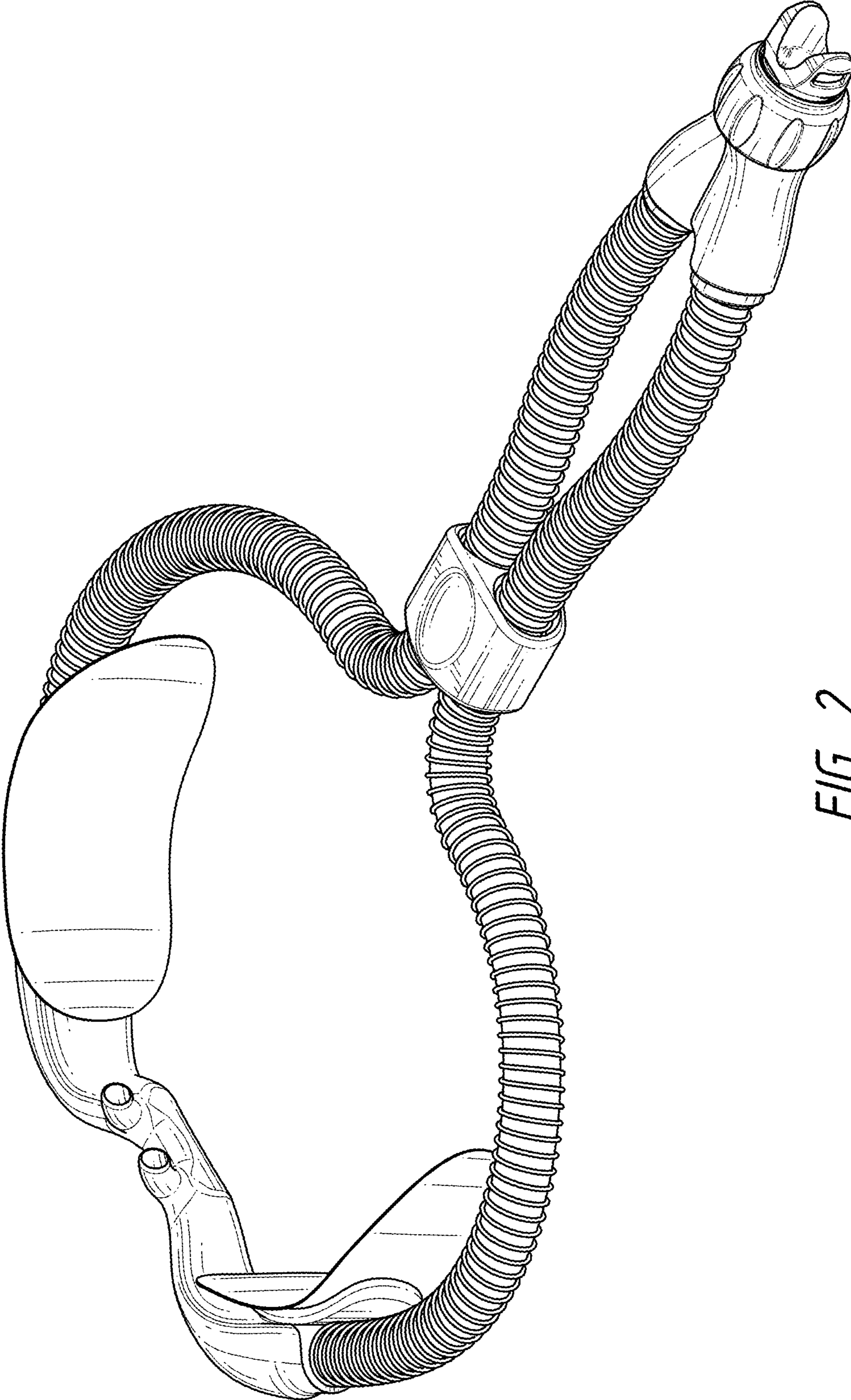

FIG. 2

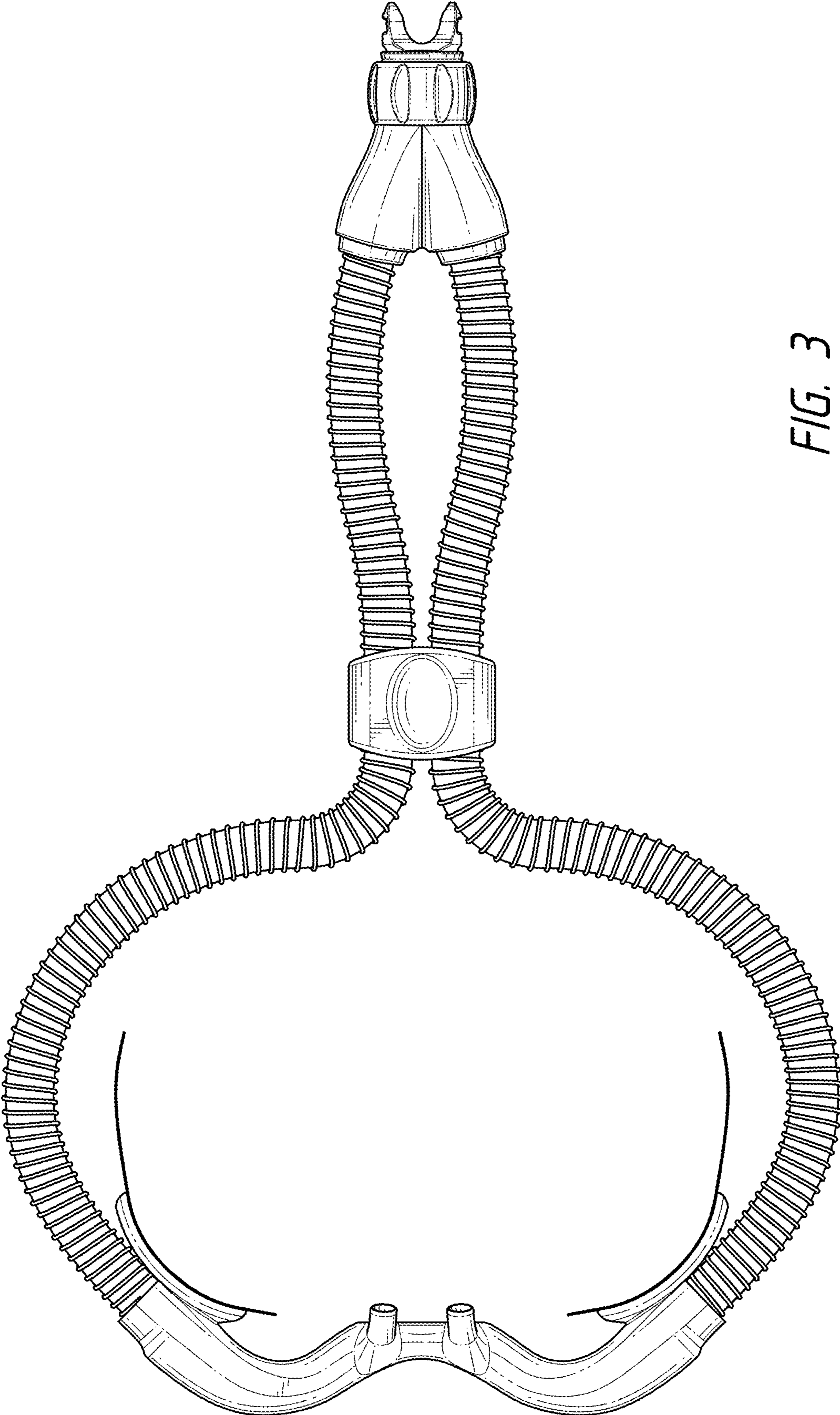

FIG. 3

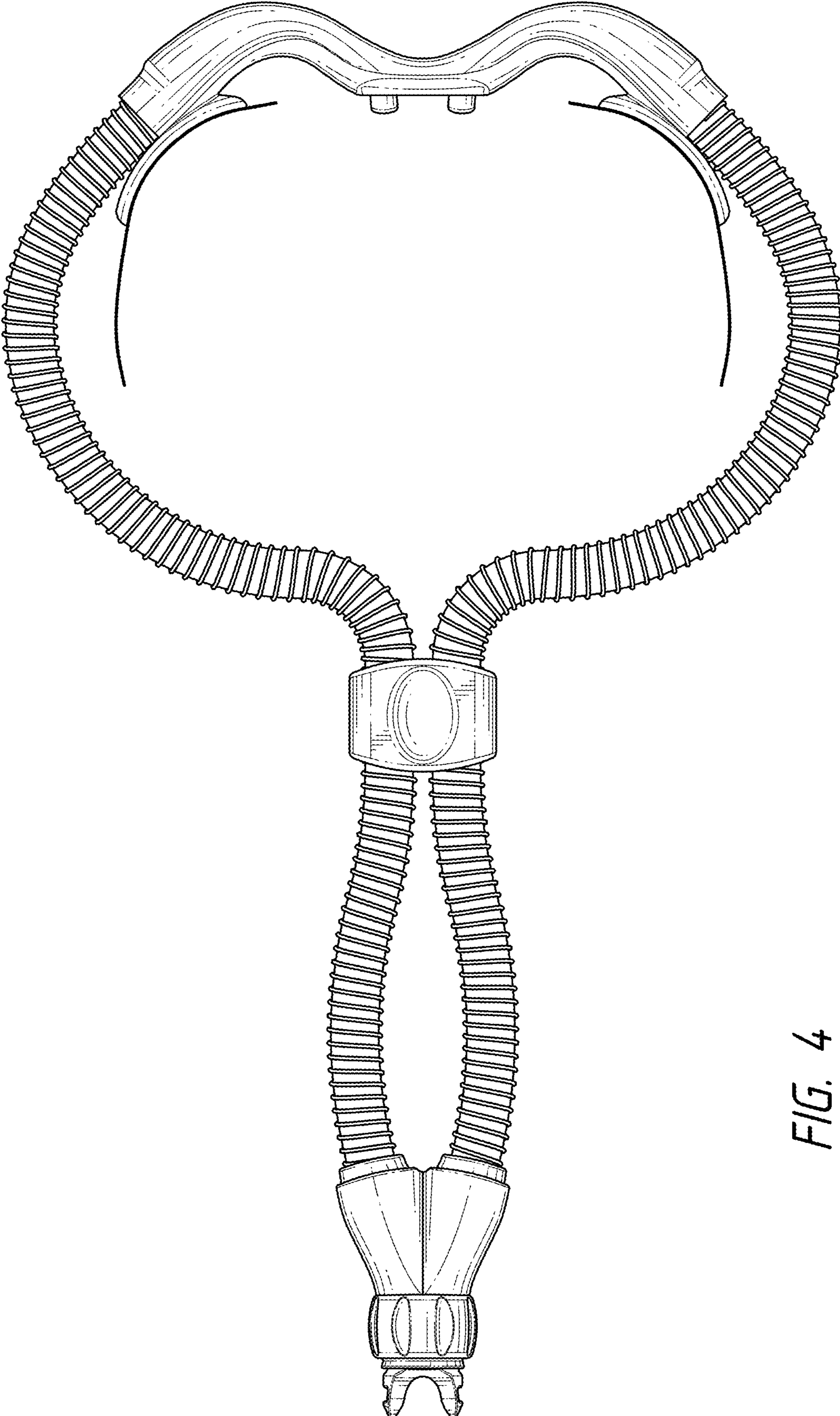

FIG. 4

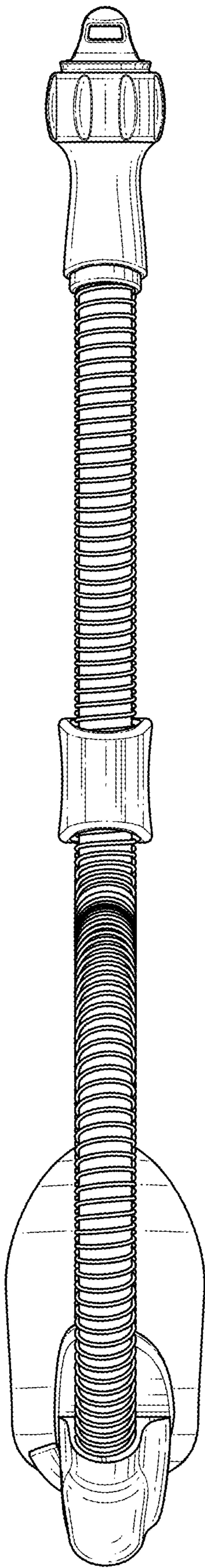

FIG. 5

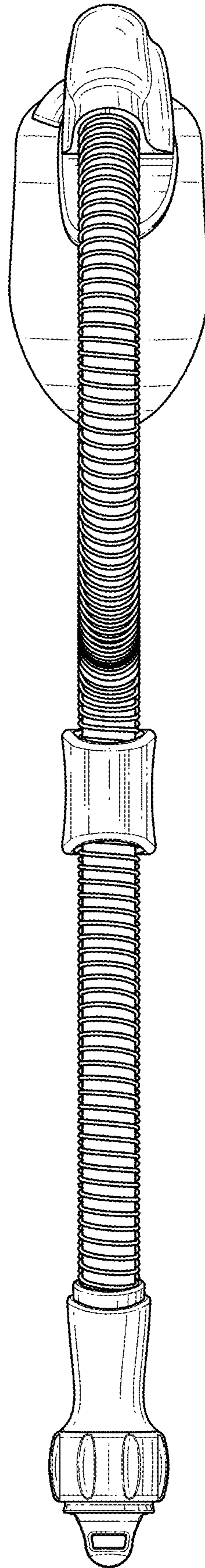

FIG. 6

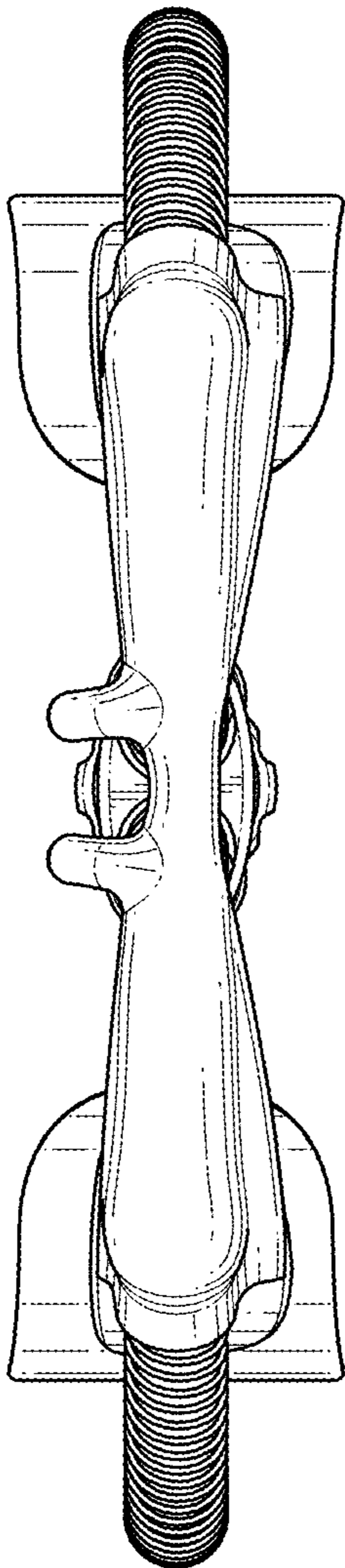

FIG. 7

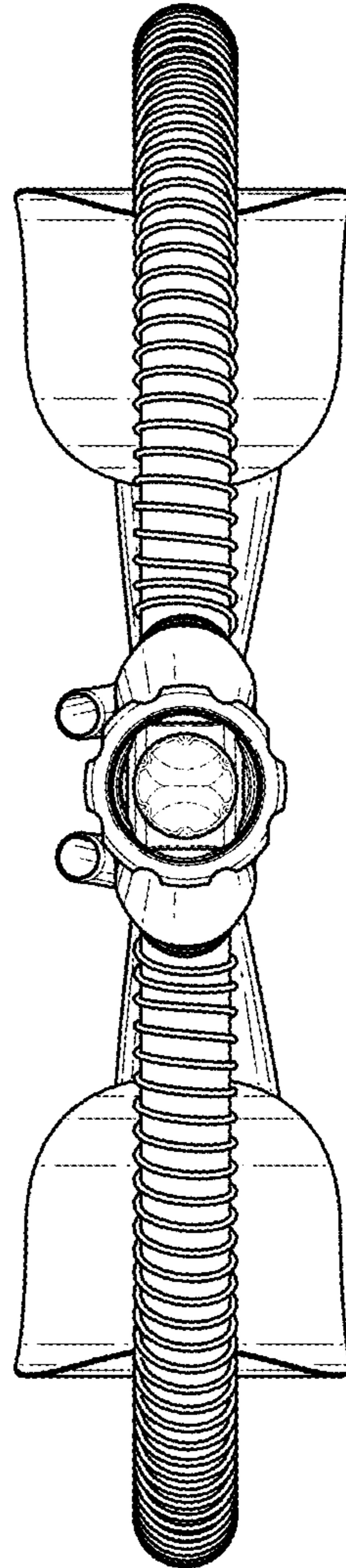

FIG. 8