



US00D870717S

(12) **United States Design Patent**
Igarashi

(10) **Patent No.:** **US D870,717 S**
(45) **Date of Patent:** **** Dec. 24, 2019**

(54) **CASE FOR PROTECTING A MOBILE DEVICE**

DESCRIPTION

(71) Applicant: **Power Support Co., Ltd.**, Tokyo (JP)

(72) Inventor: **Katsushi Igarashi**, Tokyo (JP)

(73) Assignee: **Power Support Co., Ltd.**, Tokyo (JP)

(**) Term: **15 Years**

(21) Appl. No.: **29/596,575**

(22) Filed: **Mar. 9, 2017**

(30) **Foreign Application Priority Data**

Sep. 12, 2016 (JP) 2016-19734

Sep. 12, 2016 (JP) 2016-19735

(51) **LOC (12) Cl.** **14-03**

(52) **U.S. Cl.**

USPC **D14/250**

(58) **Field of Classification Search**

USPC D3/201, 218, 226, 227, 247, 249, 250,
D3/269, 303; D13/103, 107, 108, 119;

(Continued)

(56) **References Cited**

U.S. PATENT DOCUMENTS

D551,855 S * 10/2007 Yeh D3/218

D557,894 S * 12/2007 Yeo D3/218

(Continued)

Primary Examiner — Susan E Krakower

Assistant Examiner — L. A. Grabenstetter

(74) *Attorney, Agent, or Firm* — Maier & Maier, PLLC

(57) **CLAIM**

The ornamental design for a case for protecting a mobile device, as shown and described.

FIG. 1 is a front view of a first embodiment of a case for protecting a mobile device showing my design, in a closed orientation;

FIG. 2 is a rear view thereof, in a closed orientation;

FIG. 3 is a left side view thereof, in a closed orientation;

FIG. 4 is a right side view thereof, in a closed orientation;

FIG. 5 is a top view thereof, in a closed orientation;

FIG. 6 is a bottom view thereof, in a closed orientation;

FIG. 7 is a front view thereof, in an open orientation;

FIG. 8 is a rear view thereof, in an open orientation;

FIG. 9 is a left side view thereof, in an open orientation;

FIG. 10 is a right side view thereof, in an open orientation;

FIG. 11 is a top view thereof, in an open orientation;

FIG. 12 is a bottom view thereof, in an open orientation;

FIG. 13 is a front perspective view thereof, in an open orientation;

FIG. 14 is a front view of a second embodiment of a case for protecting a mobile device showing my design, in a closed orientation;

FIG. 15 is a rear view thereof, in a closed orientation;

FIG. 16 is a left side view thereof, in a closed orientation;

FIG. 17 is a right side view thereof, in a closed orientation;

FIG. 18 is a top view thereof, in a closed orientation;

FIG. 19 is a bottom view thereof, in a closed orientation;

FIG. 20 is a front view thereof, in an open orientation;

FIG. 21 is a rear view thereof, in an open orientation;

FIG. 22 is a left side view thereof, in an open orientation;

FIG. 23 is a right side view thereof, in an open orientation;

FIG. 24 is a top view thereof, in an open orientation;

FIG. 25 is a bottom view thereof, in an open orientation; and,

FIG. 26 is a front perspective view thereof, in an open orientation.

1 Claim, 26 Drawing Sheets

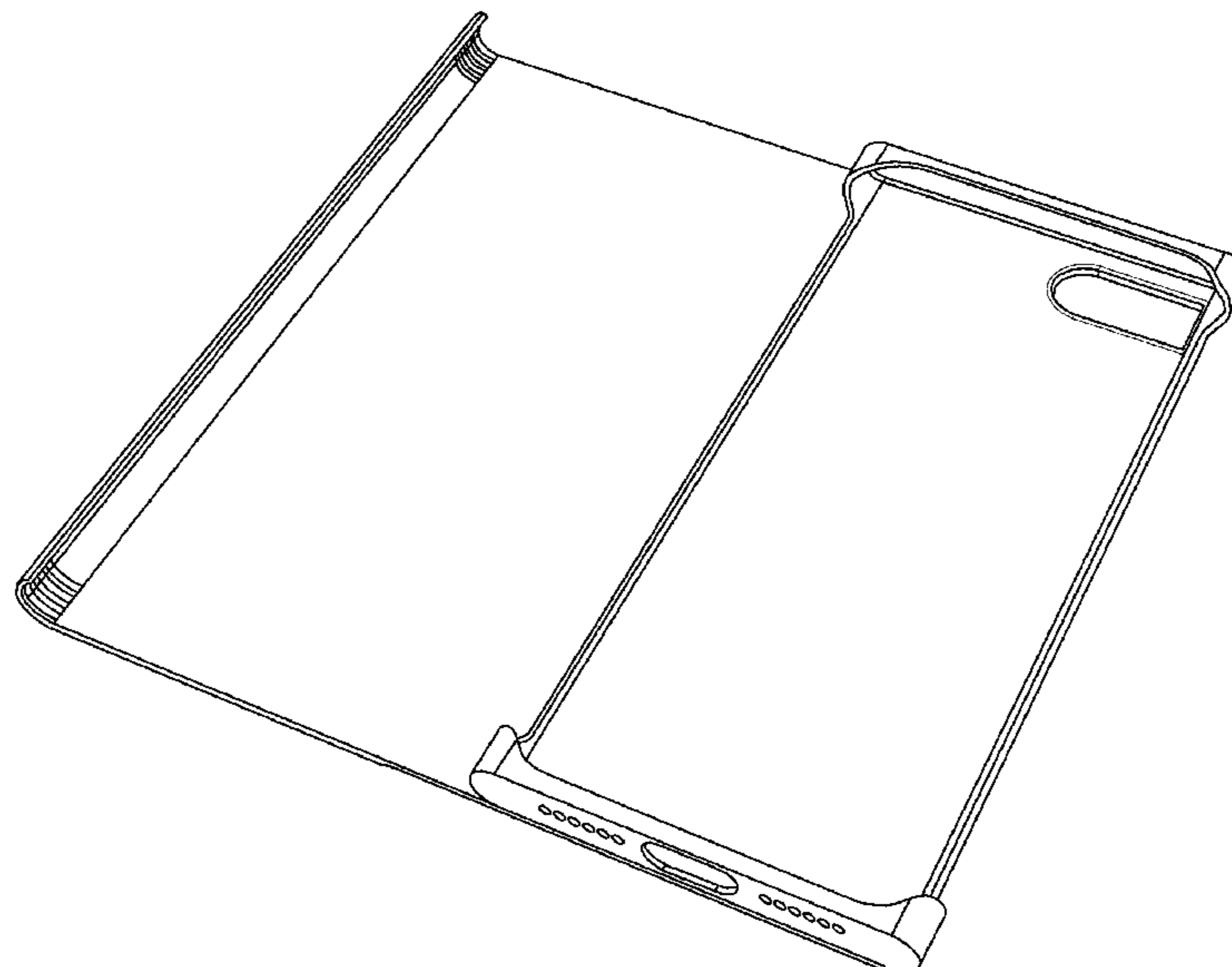

(58) **Field of Classification Search**

USPC D14/137, 138 R, 138 AA, 138 C, 138 G,
 D14/172, 192, 203.3–203.7, 217, 238.1,
 D14/247, 248, 250–253, 434, 440, 447,
 D14/496
 CPC H04B 1/3888; H04M 1/0283; H04M
 1/0202; A45C 1/06; A45C 2011/002;
 A45C 11/00; A45F 2005/028; A45F
 2200/0525

See application file for complete search history.

(56) **References Cited**

U.S. PATENT DOCUMENTS

D609,901 S * 2/2010 Behar D3/218
 D656,497 S * 3/2012 Chiu D14/341
 D670,293 S * 11/2012 Shimizu D14/440
 D683,954 S * 6/2013 Izen D3/218
 D685,990 S * 7/2013 Zhang D3/218

D705,534 S * 5/2014 Manjerico D3/218
 D729,522 S * 5/2015 Kim D3/218
 D733,111 S * 6/2015 Kim D14/250
 D757,700 S * 5/2016 Park D14/250
 D757,714 S * 5/2016 Akana D14/341
 D760,213 S * 6/2016 Song D14/250
 D761,781 S * 7/2016 Dang D14/250
 D765,631 S * 9/2016 Harata D14/250
 D765,639 S * 9/2016 Lay D14/250
 D768,616 S * 10/2016 Harata D14/250
 D772,214 S * 11/2016 Daniel D14/250
 D774,496 S * 12/2016 Kim D14/250
 D774,497 S * 12/2016 Kim D14/250
 D775,616 S * 1/2017 Kim D14/250
 D776,645 S * 1/2017 Del Moral D14/250
 D777,421 S * 1/2017 Grote D14/250
 D779,473 S * 2/2017 Lee D14/250
 D813,218 S * 3/2018 Igarashi D14/250
 D829,199 S * 9/2018 Igarashi D14/250

* cited by examiner

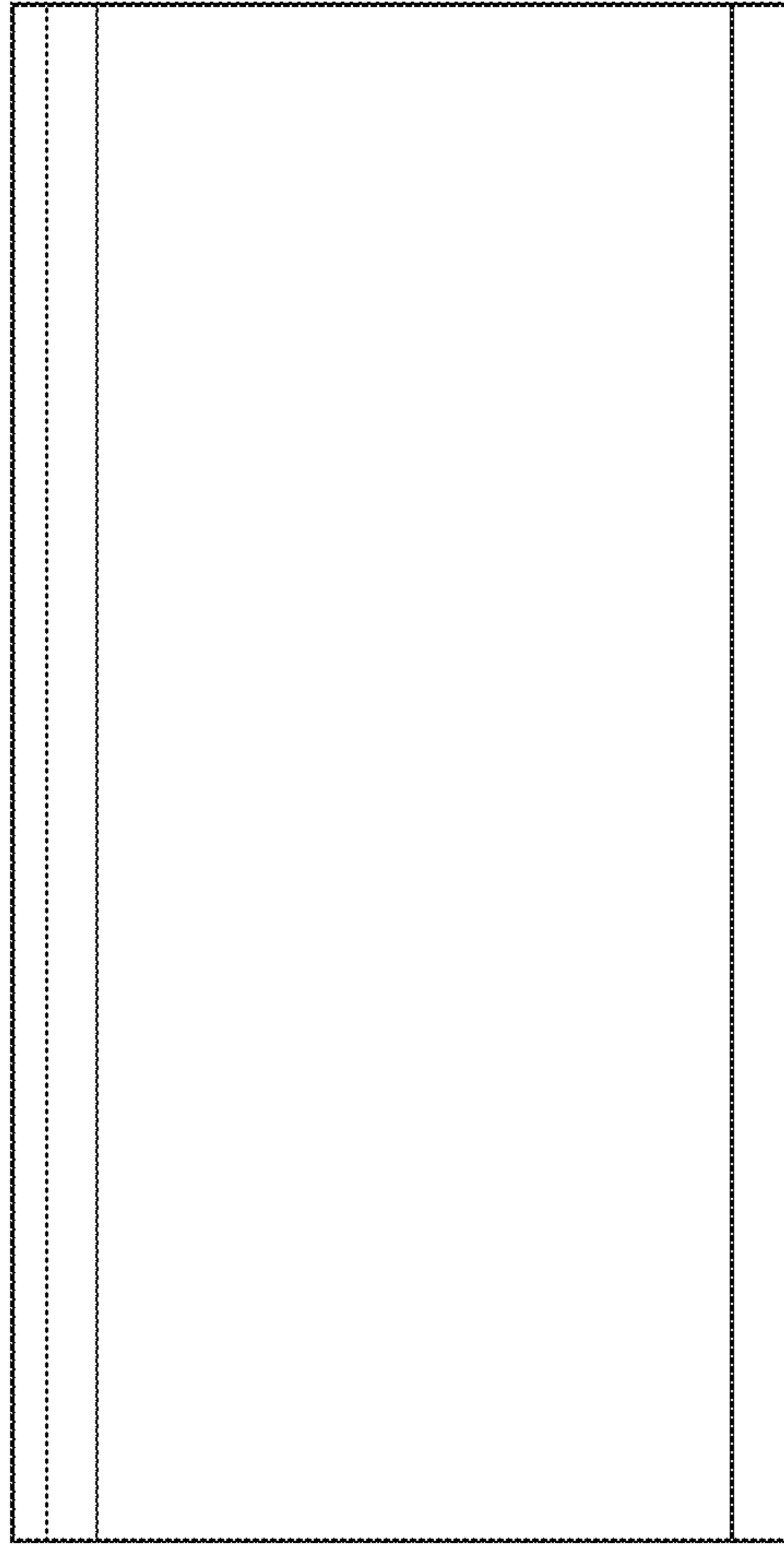

FIG. 1

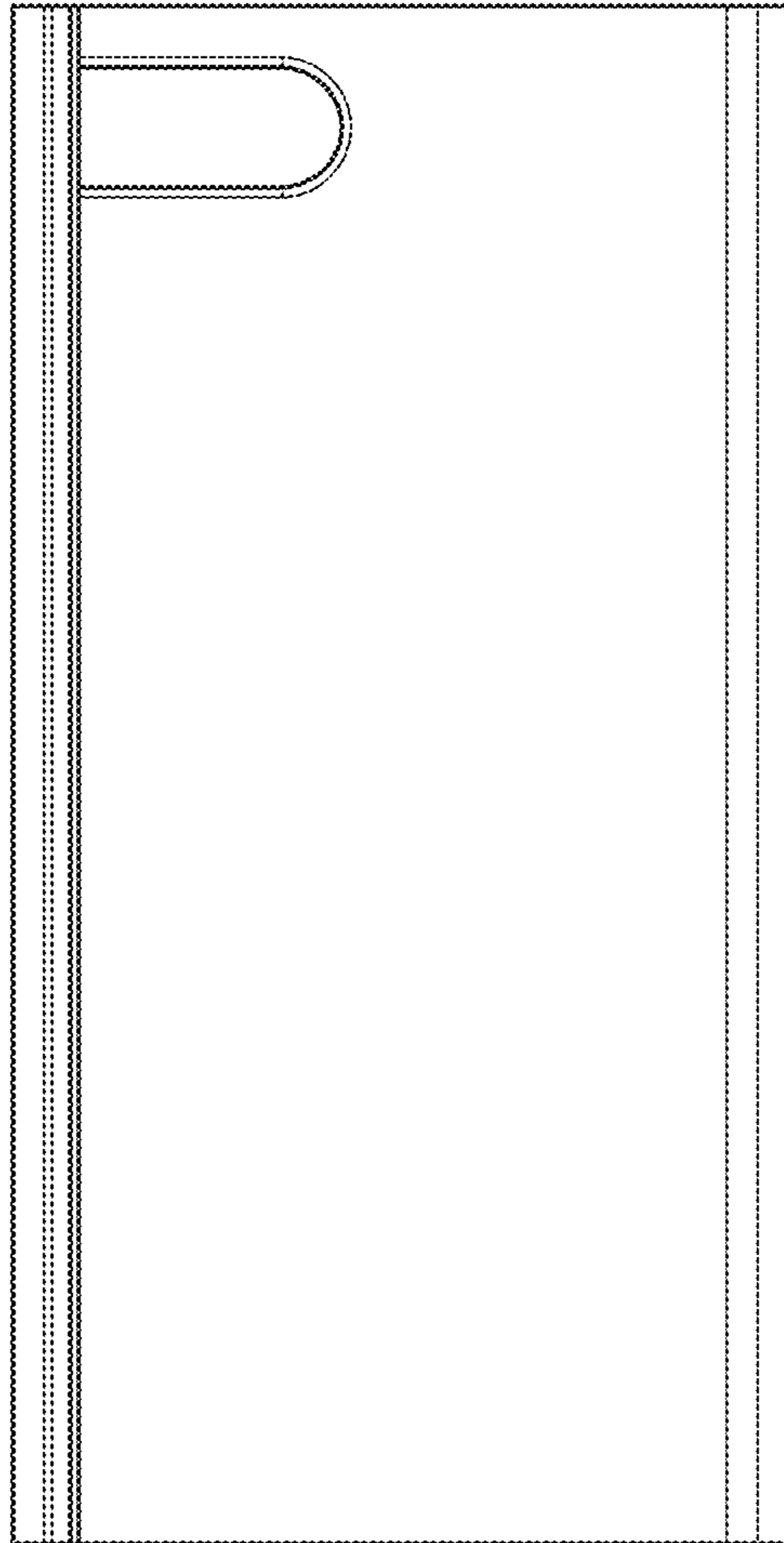

FIG. 2

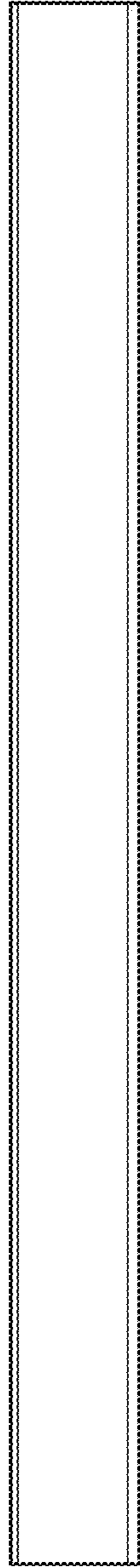

FIG. 3

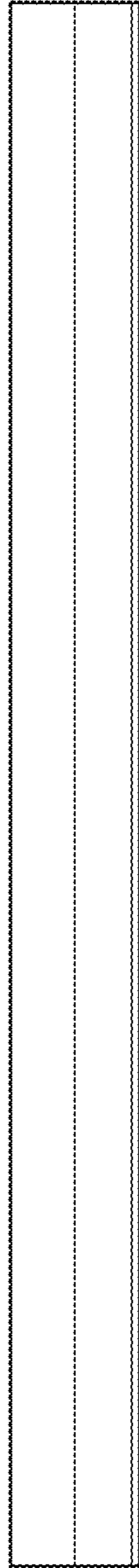

FIG. 4



FIG. 5

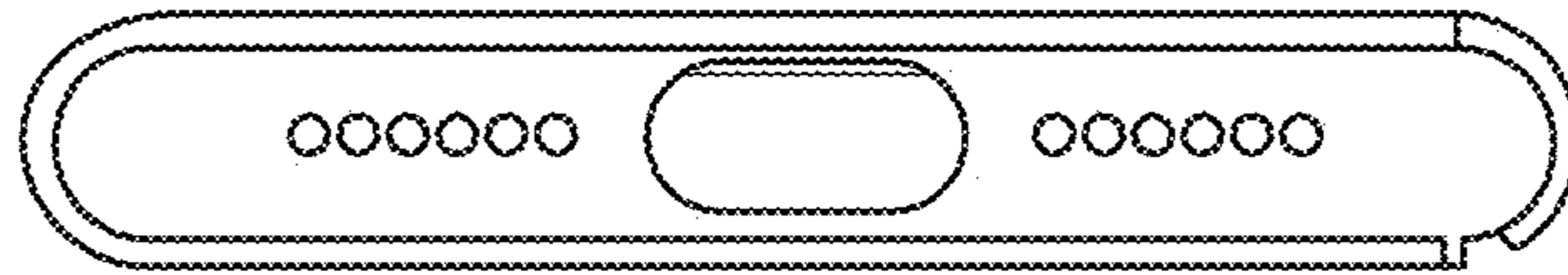

FIG. 6

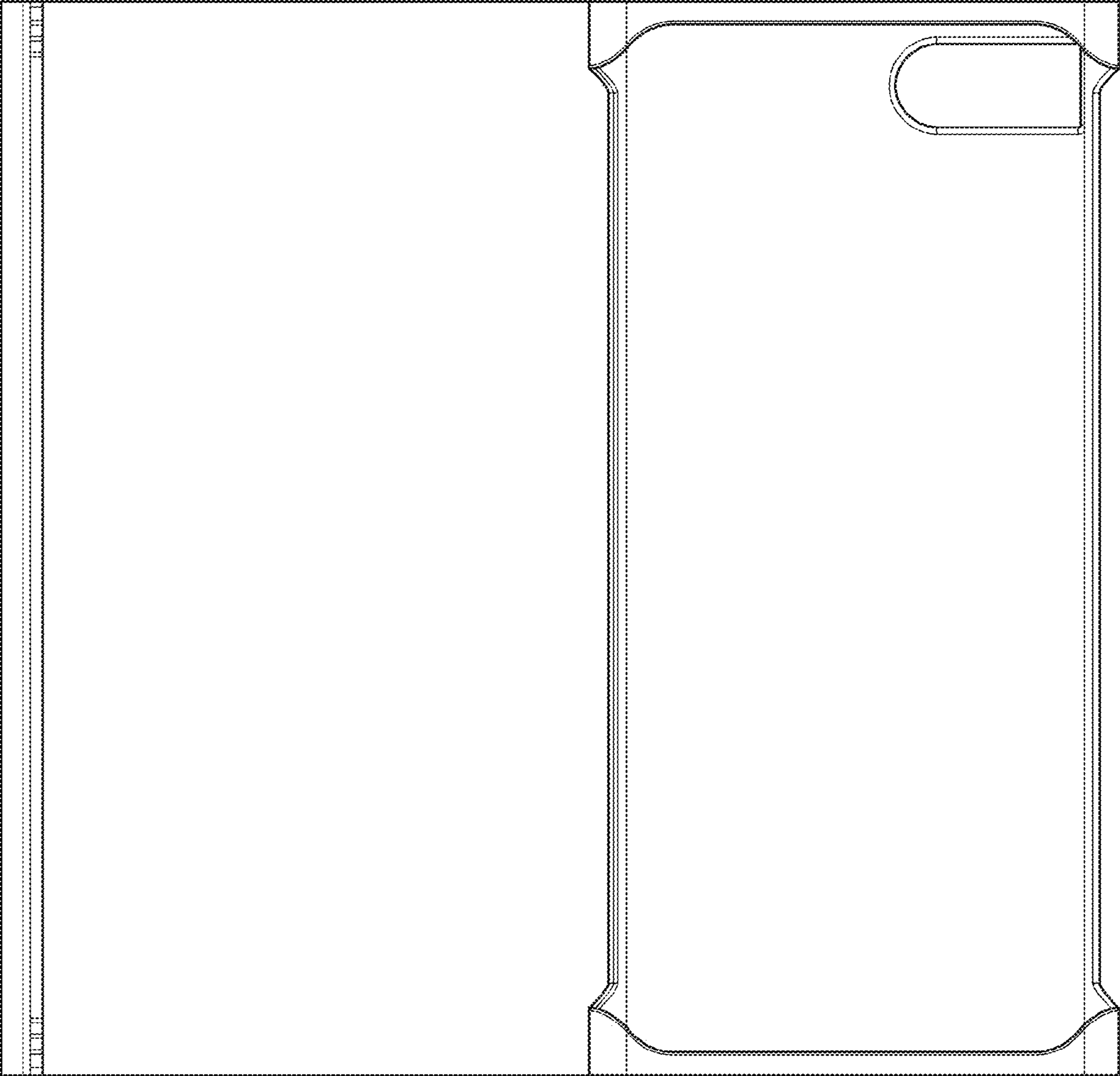

FIG. 7

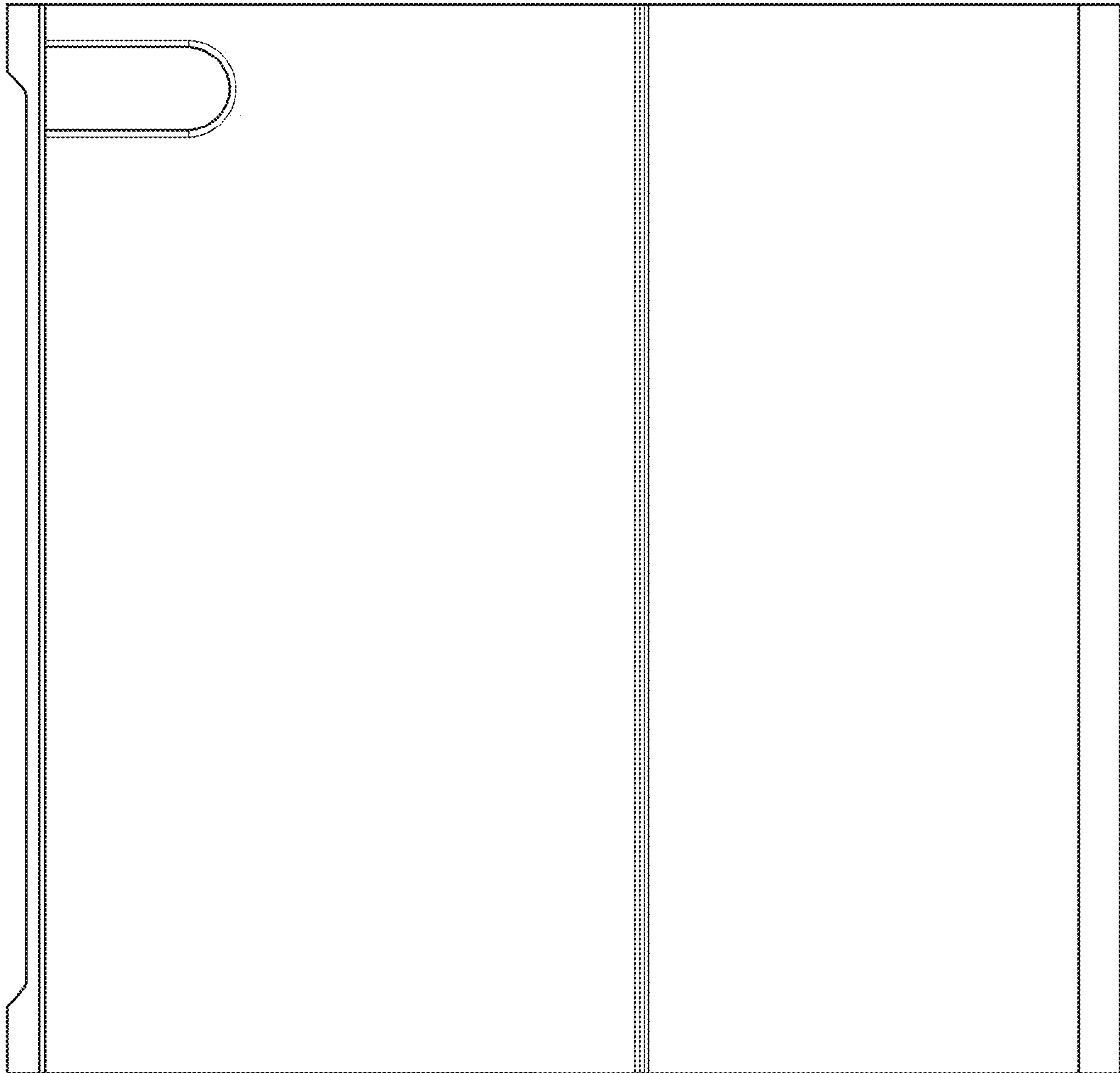

FIG. 8

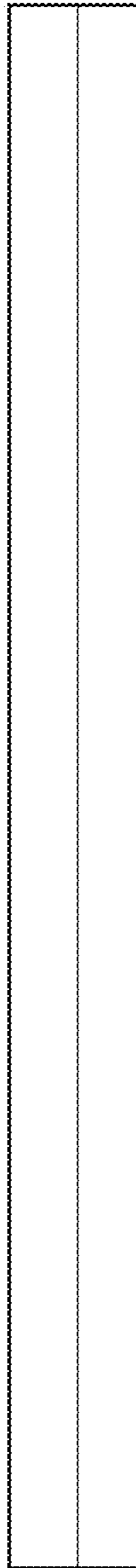

FIG. 9

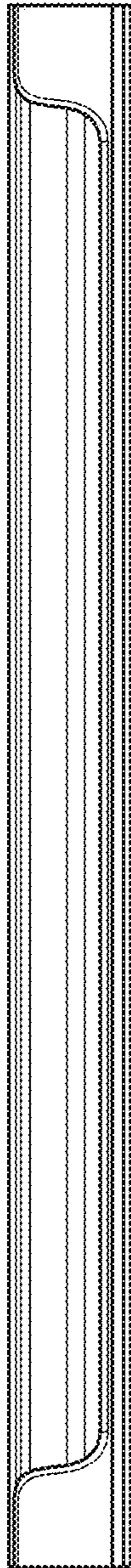

FIG. 10

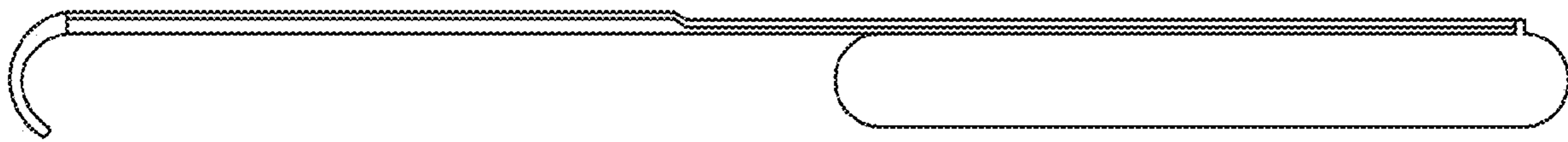

FIG. 11

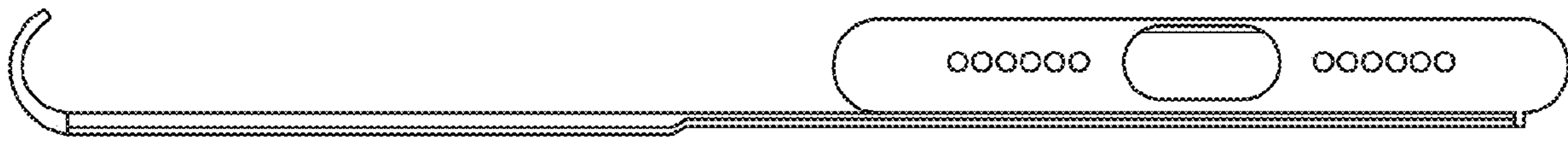

FIG. 12

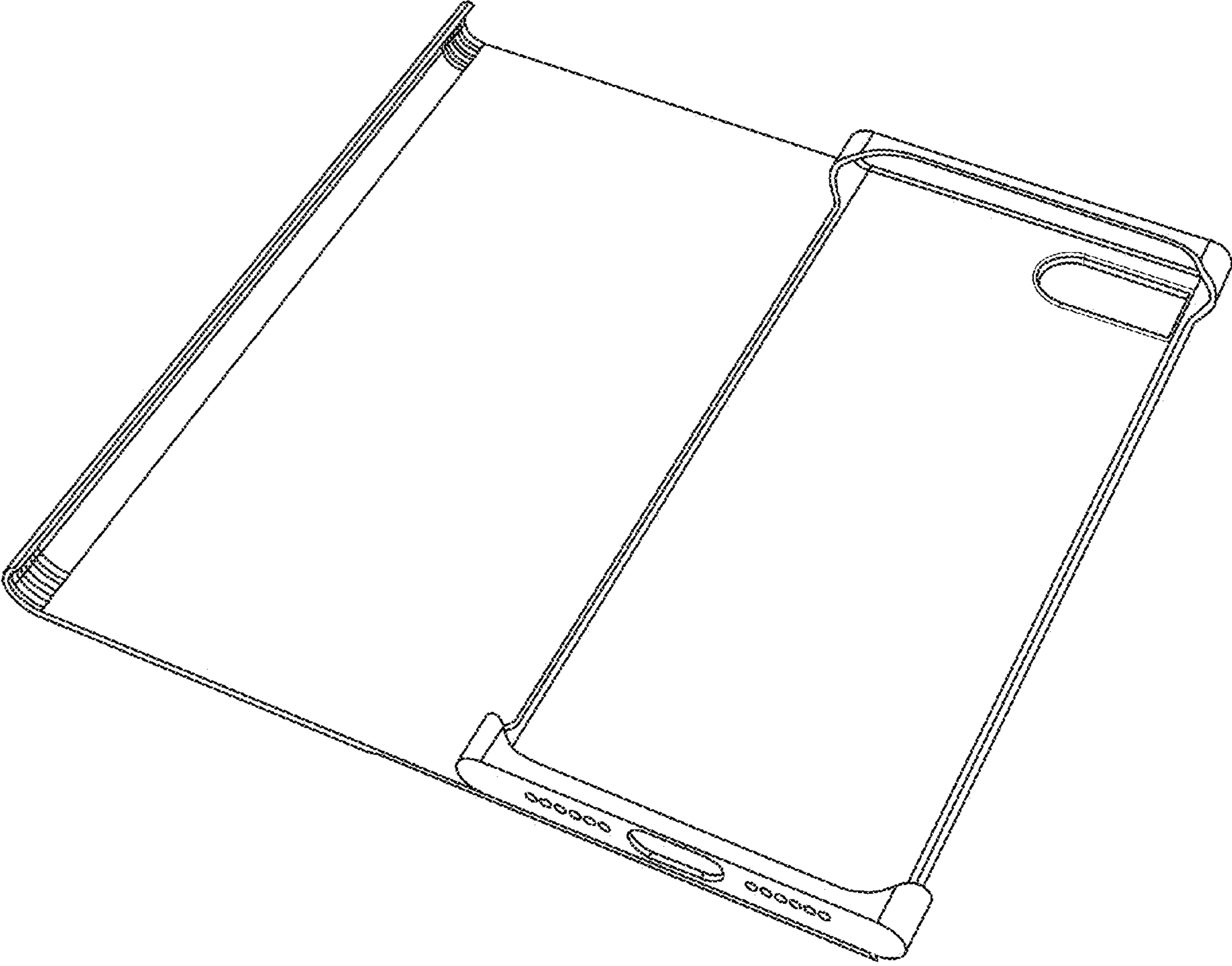

FIG. 13

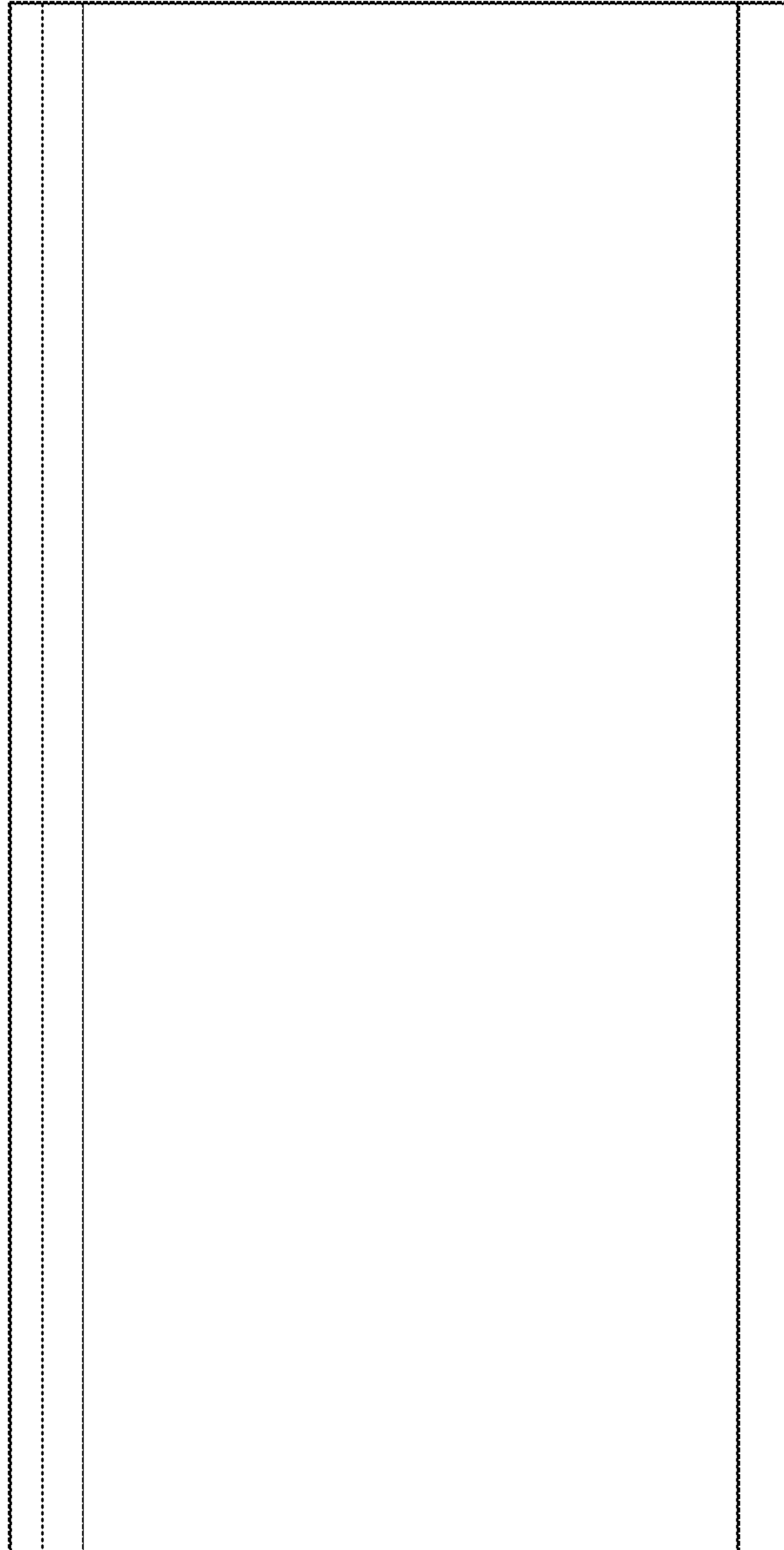

FIG. 14

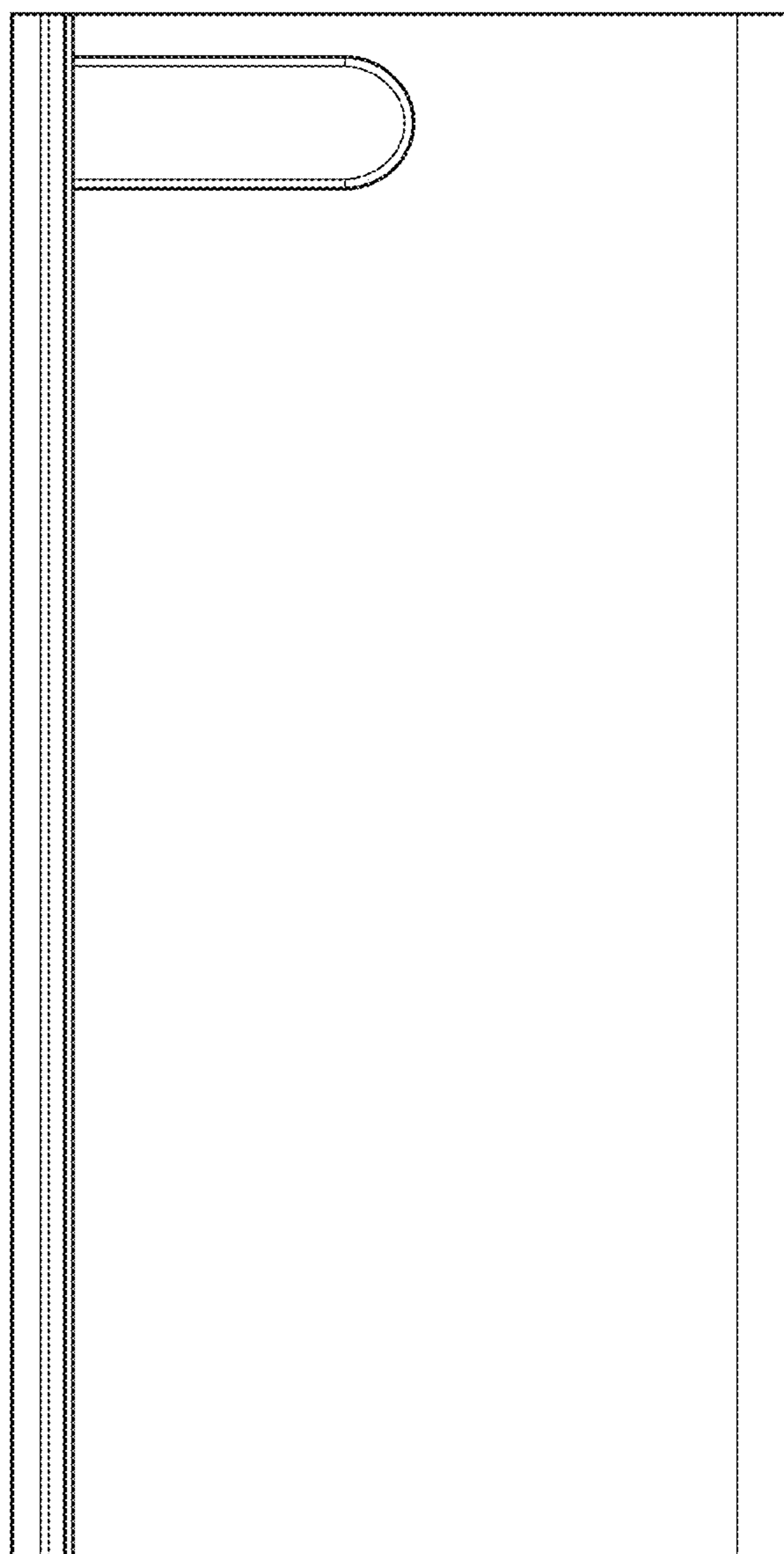

FIG. 15

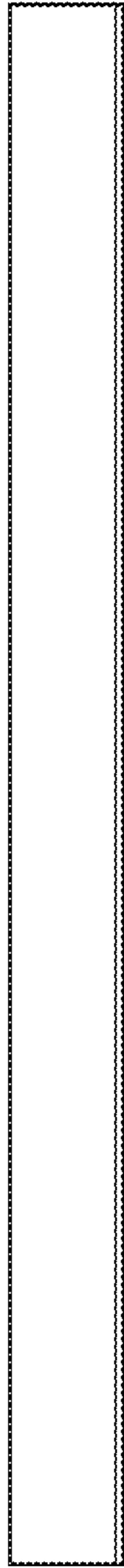

FIG. 16

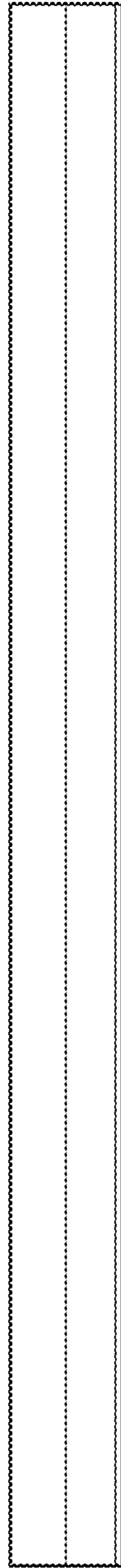

FIG. 17

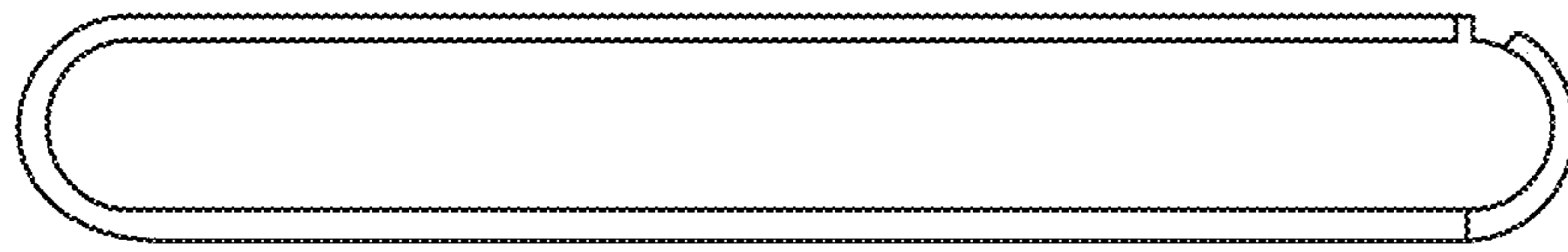

FIG. 18

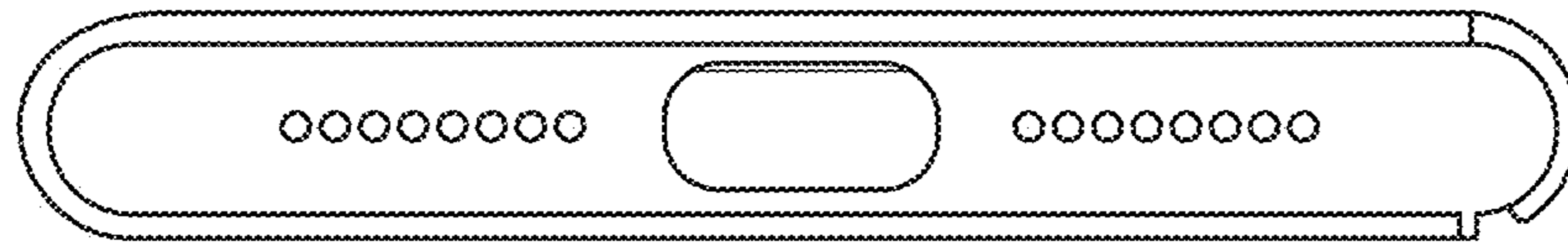

FIG. 19

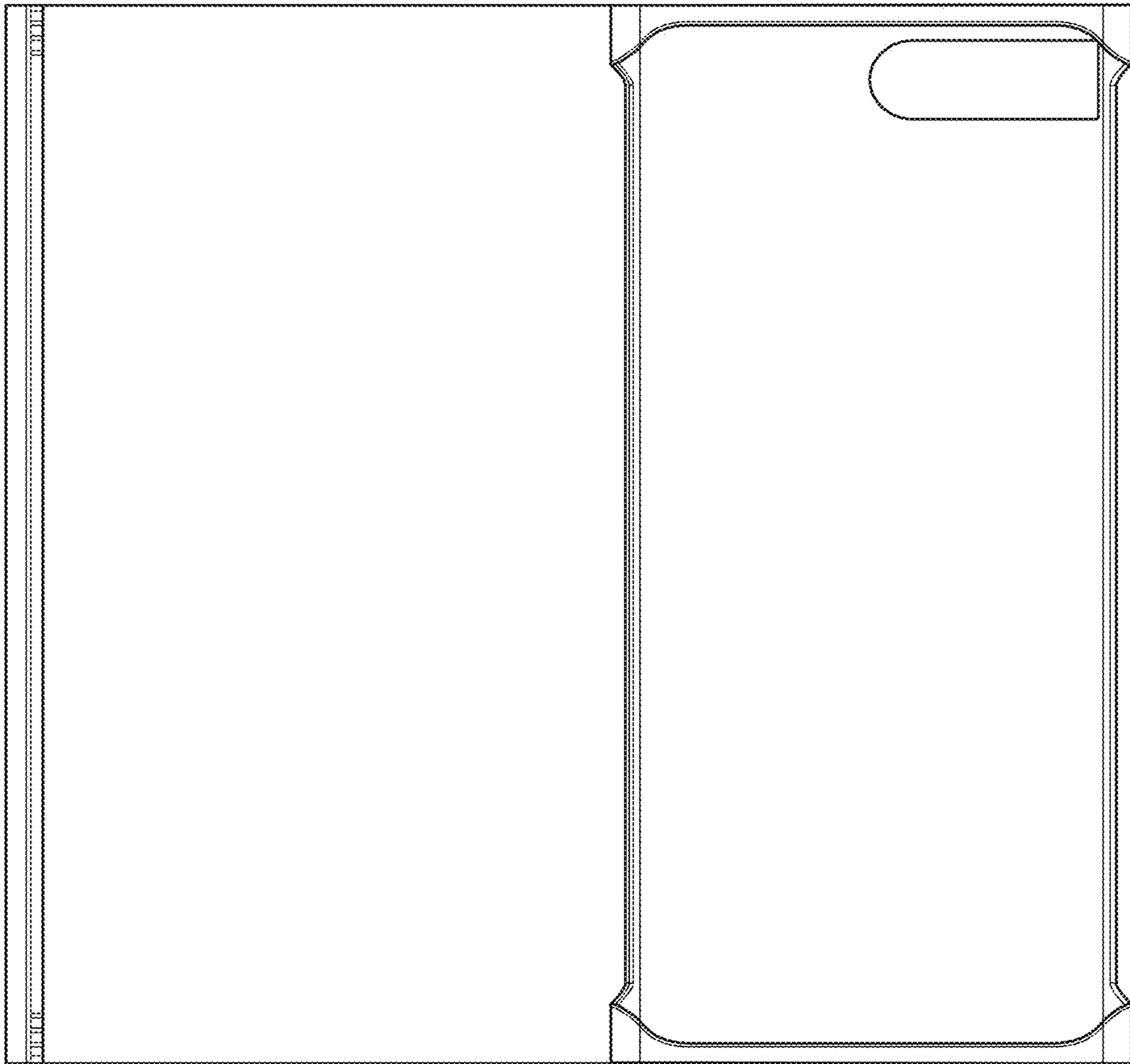

FIG. 20

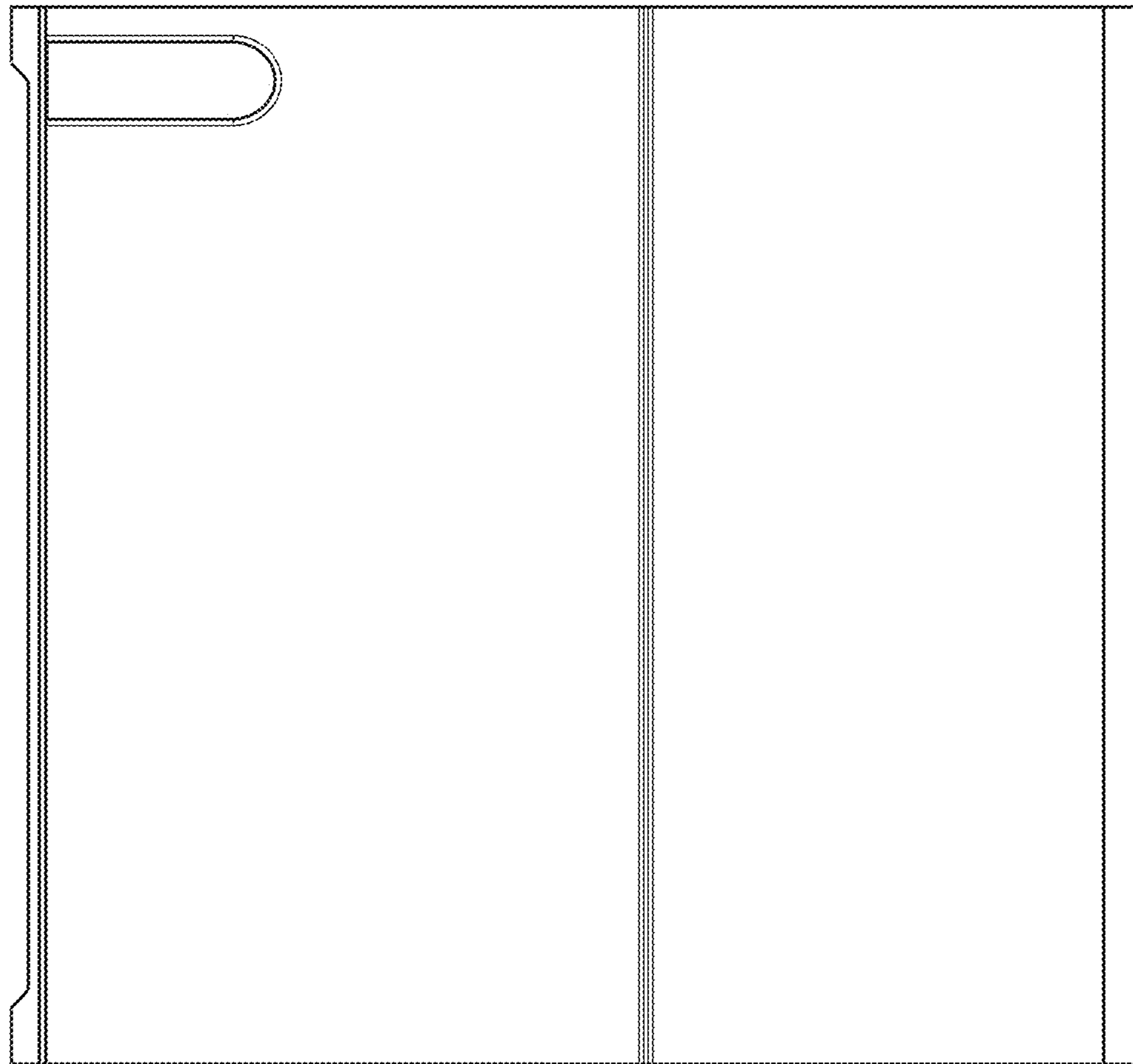

FIG. 21

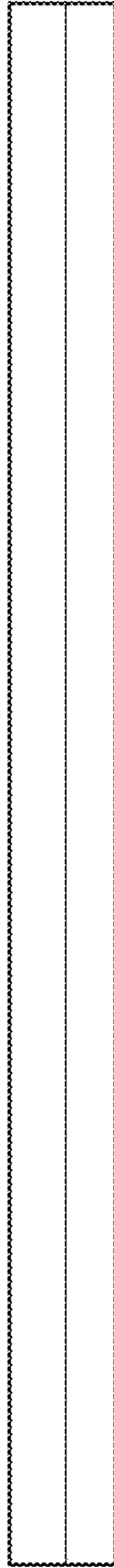

FIG. 22



FIG. 23

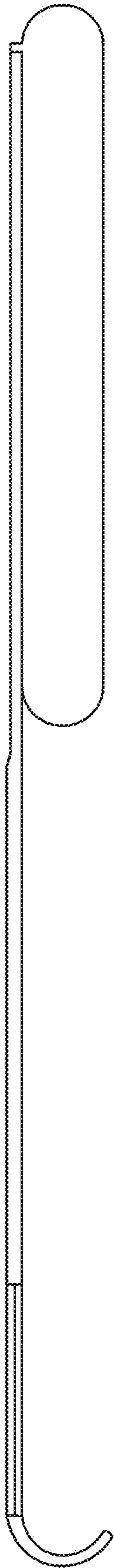

FIG. 24

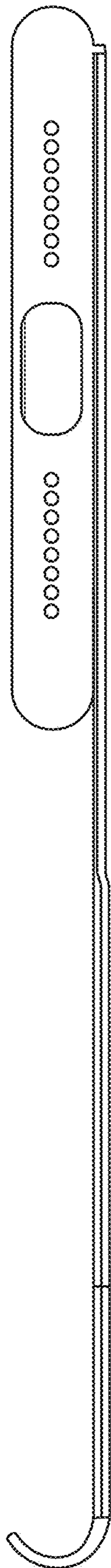

FIG. 25

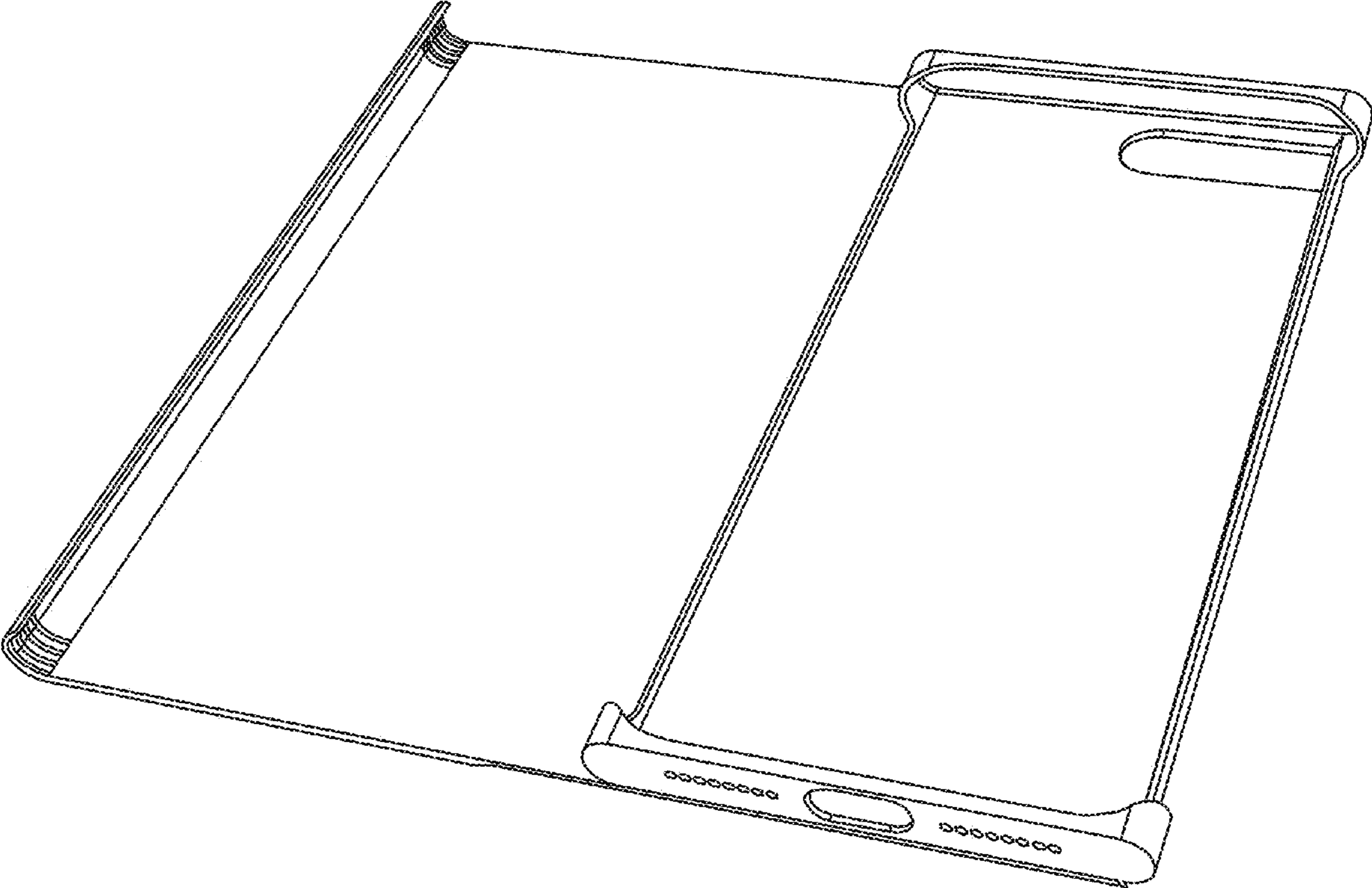

FIG. 26