



US00D870516S

(12) **United States Design Patent**  
**Villasenor**

(10) **Patent No.:** **US D870,516 S**

(45) **Date of Patent:** **\*\* Dec. 24, 2019**

- (54) **CRAWFISH TRAY**
- (71) Applicant: **CAJUN PARTY BOAT LLC**, Des Allemands, LA (US)
- (72) Inventor: **Alultimo Villasenor**, Des Allemands, LA (US)
- (\*\*) Term: **15 Years**
- (21) Appl. No.: **29/658,669**
- (22) Filed: **Aug. 1, 2018**
- (51) **LOC (12) Cl.** ..... **07-01**
- (52) **U.S. Cl.**  
USPC ..... **D7/553.5**
- (58) **Field of Classification Search**  
USPC ..... D7/396.4, 501, 505, 571, 538, 540, D7/541-543, 545, 546, 549, 552.1, 553, D7/553.1, 553.2, 553.6, 554.2; D9/424, D9/432, 716, 719, 738-740, 744-745, D9/756, 759-760, 761; D30/130  
CPC ..... B65D 1/34; B65D 21/00; B65D 21/0204  
See application file for complete search history.

5,598,944 A *	2/1997	Aragona	.....	A47G 19/06	206/518
D378,477 S *	3/1997	Sussman	.....	D6/406.5	
D404,218 S *	1/1999	Sussman	.....	D6/406.5	
D423,290 S *	4/2000	Green	.....	D6/406.1	
D652,323 S *	1/2012	Clark	.....	D9/425	
D713,208 S *	9/2014	Clark	.....	D7/553.5	
D727,108 S *	4/2015	Sheppard	.....	D7/505	
9,113,735 B1 *	8/2015	Jansma	.....	A47G 23/0208	
D750,976 S *	3/2016	Tilahun	.....	D9/737	
D785,406 S *	5/2017	Wansink	.....	D7/553.2	
D822,506 S *	7/2018	Tilahun	.....	D9/761	
D845,077 S *	4/2019	Hla	.....	D7/553.1	
D845,078 S *	4/2019	Hyman	.....	D7/553.1	
D848,795 S *	5/2019	Butler	.....	D7/553.6	
2004/0238537 A1 *	12/2004	Ojeda	.....	B60N 3/002	220/23.8

\* cited by examiner

*Primary Examiner* — Kelley A Donnelly  
(74) *Attorney, Agent, or Firm* — Norton IP Law Firm LLC; Taylor M. Norton

(57) **CLAIM**

The ornamental design for a crawfish tray, as shown and described.

(56) **References Cited**

U.S. PATENT DOCUMENTS

2,897,974 A *	8/1959	Cook	.....	A47G 23/06	211/74
D255,081 S *	5/1980	Ramorini	.....	D11/156	
4,219,144 A *	8/1980	Hagelberg	.....	A47G 19/065	206/563
D280,669 S *	9/1985	Hammeke	.....	D3/308	
D296,404 S *	6/1988	Lowenbein	.....	A47G 19/065	D7/553.1
5,323,910 A *	6/1994	van de Graaf, Jr.	.....	A47G 19/065	206/557
D349,425 S *	8/1994	Kays	.....	D7/549	

**DESCRIPTION**

FIG. 1 is a perspective view of a crawfish tray;  
FIG. 2 is a front elevation view thereof;  
FIG. 3 is a rear elevation view thereof;  
FIG. 4 is a right elevation view thereof, the left elevation view being a mirror image of the right elevation view;  
FIG. 5 is top plan view thereof; and,  
FIG. 6 is a bottom plan view thereof.

**1 Claim, 6 Drawing Sheets**

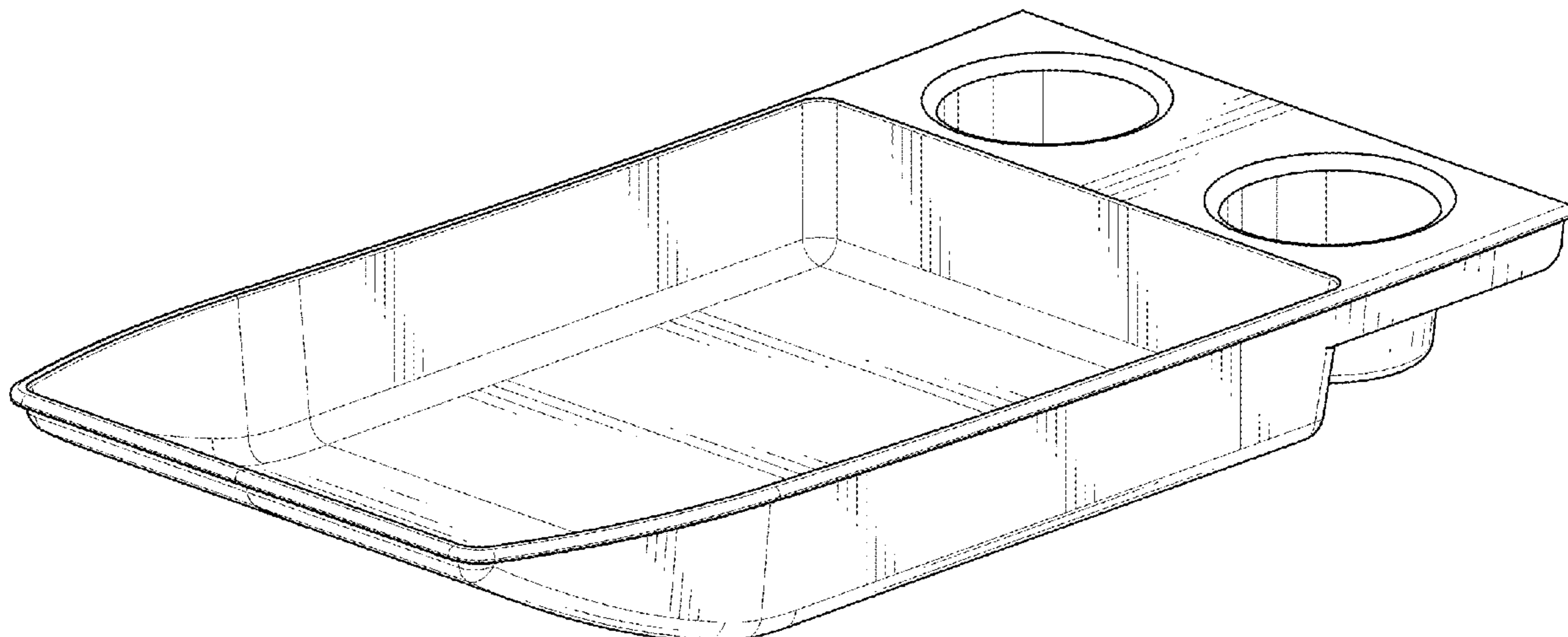

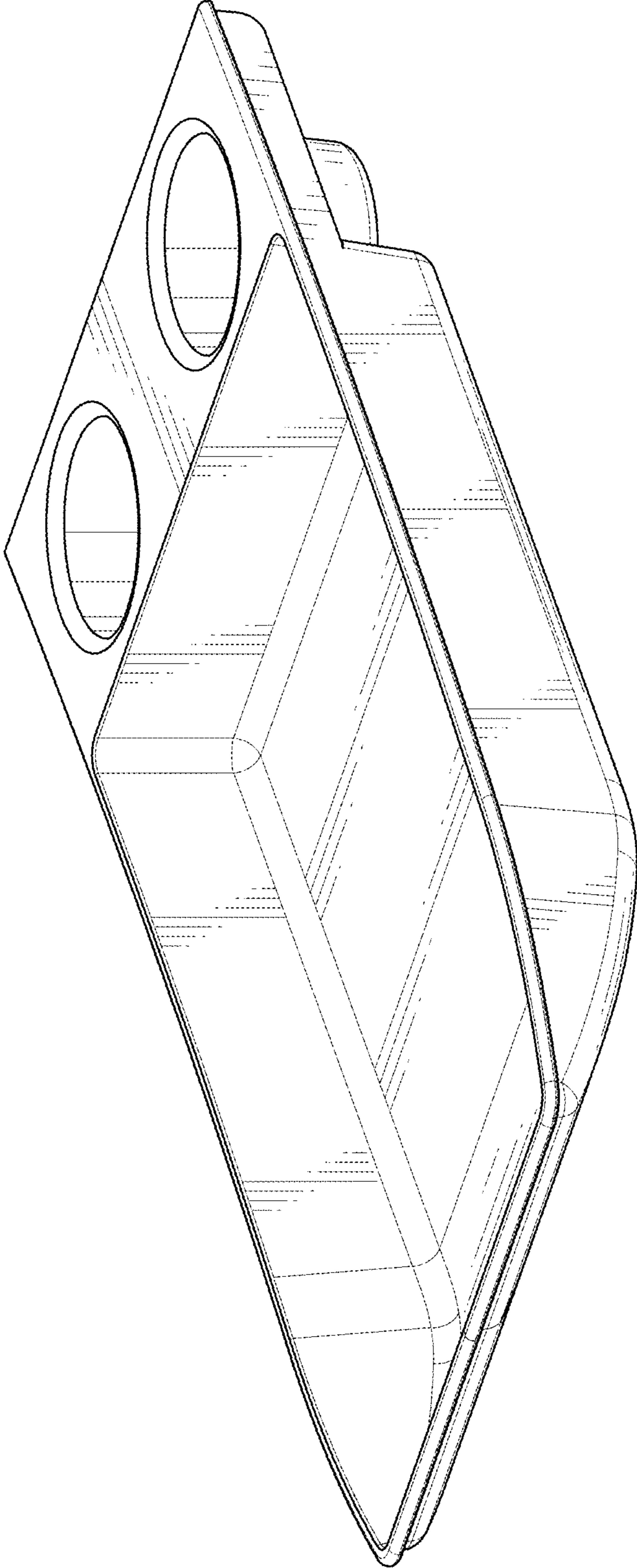

FIG. 1

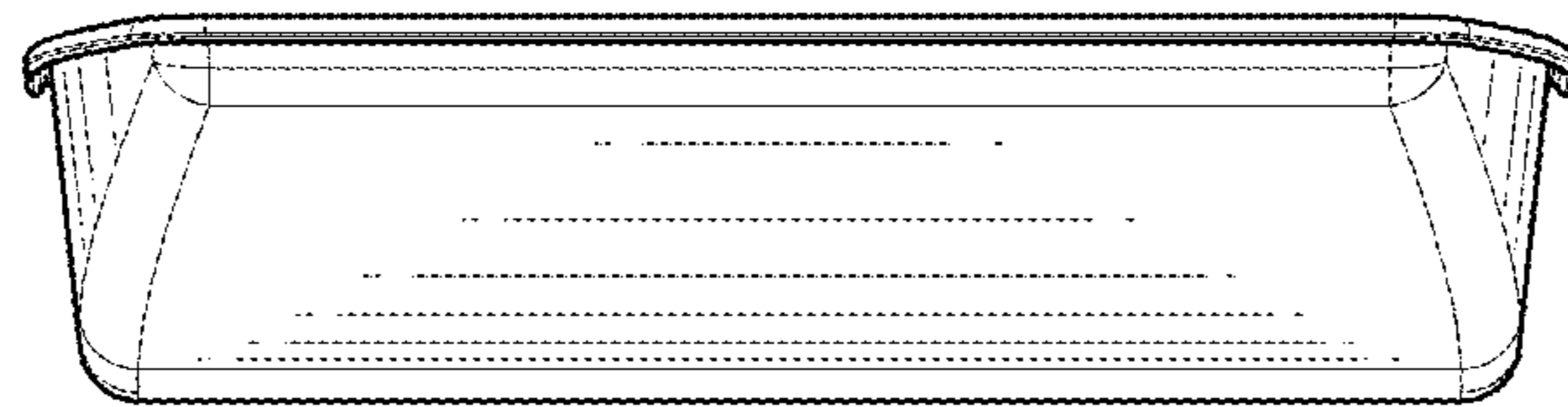

FIG. 2

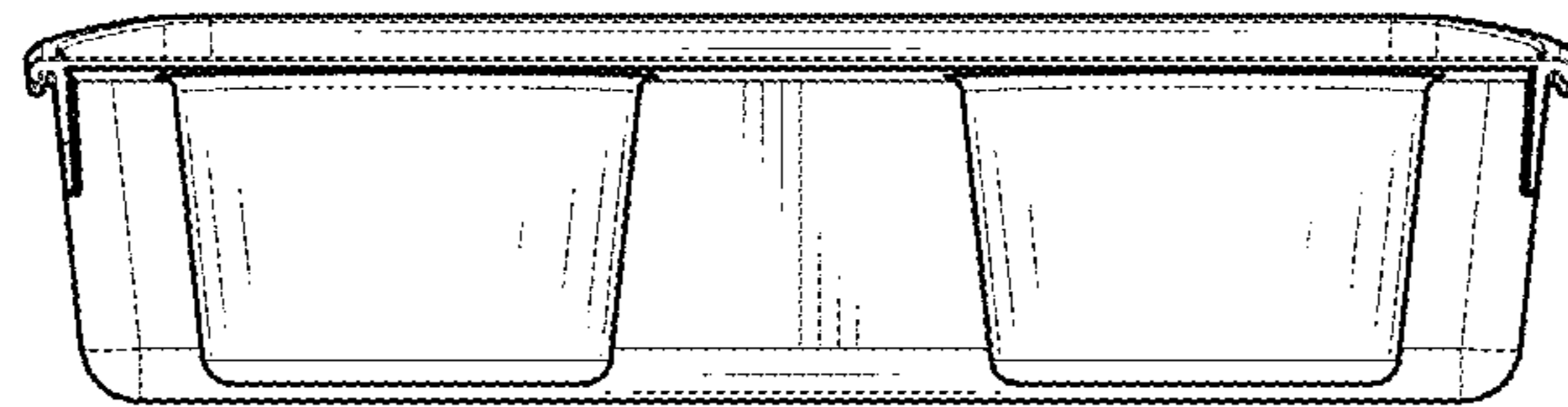

FIG. 3

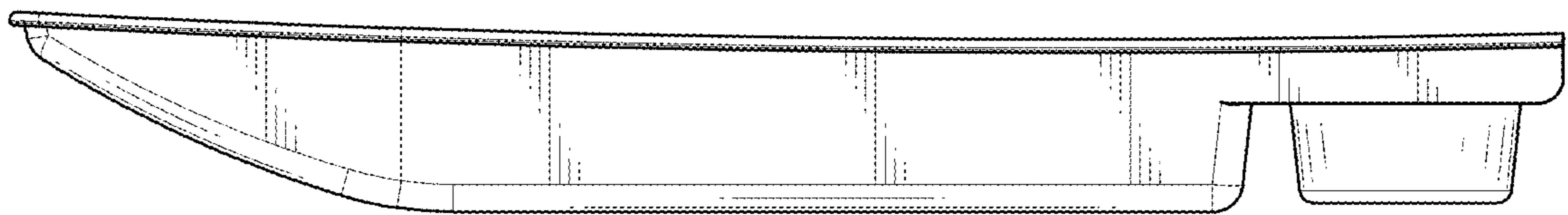

FIG. 4

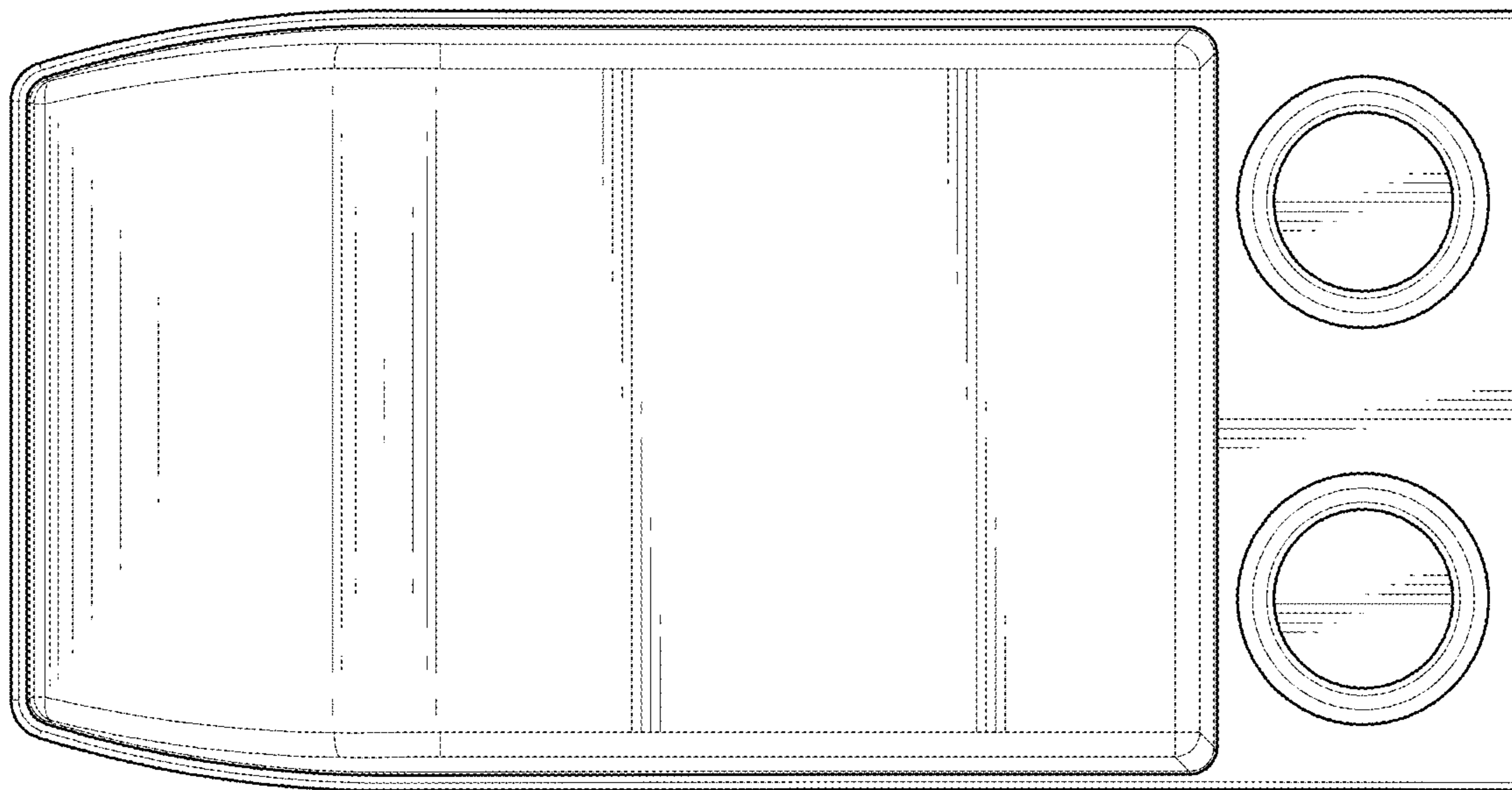

FIG. 5



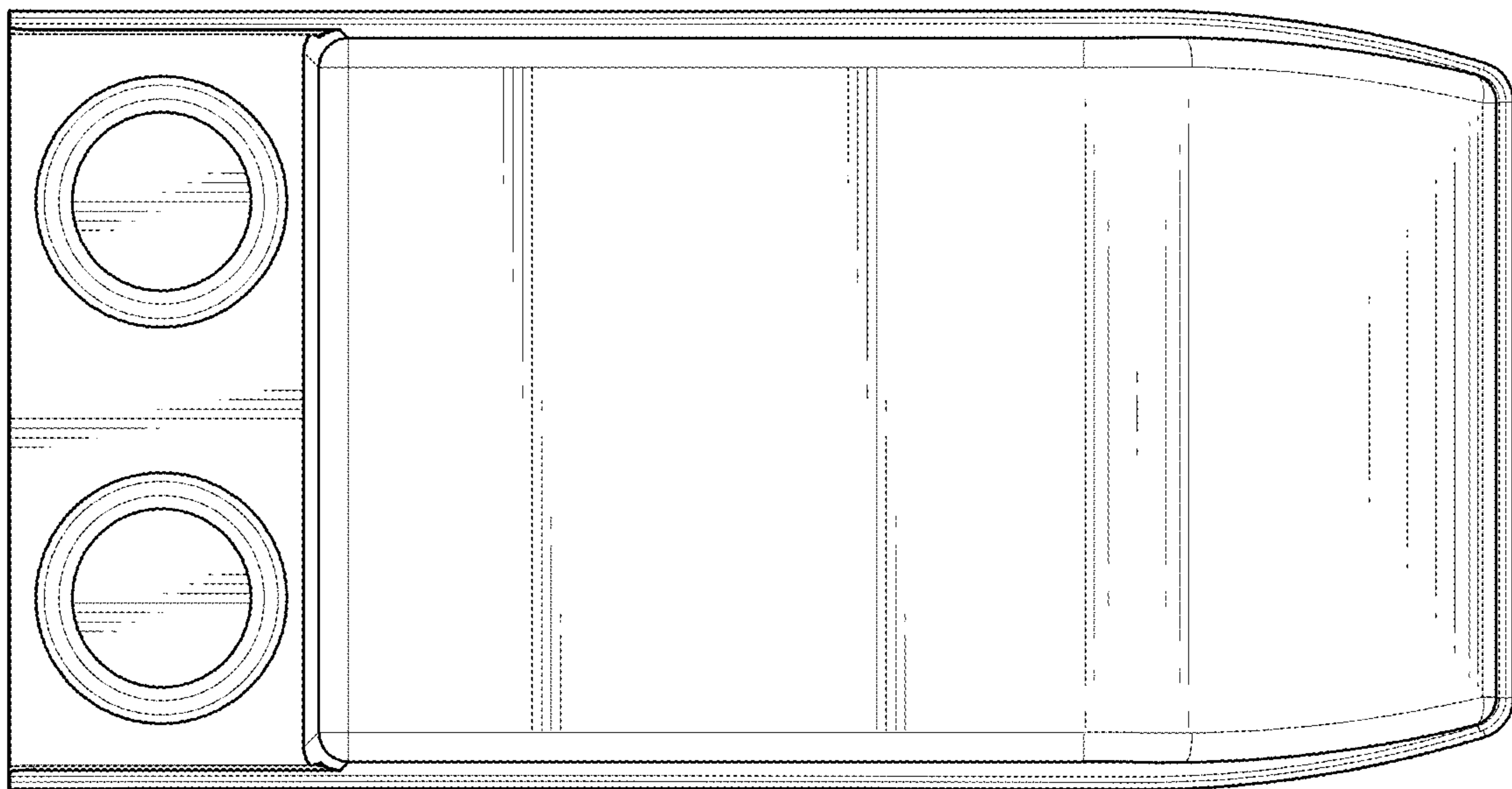

FIG. 6