



US00D870492S

(12) **United States Design Patent** (10) **Patent No.:** **US D870,492 S**
Young (45) **Date of Patent:** **** Dec. 24, 2019**

(54) **CONSOLE**
(71) Applicant: **Blu Dot Design & Manufacturing, Inc.**, Minneapolis, MN (US)
(72) Inventor: **Warren Young**, Roseville, MN (US)
(73) Assignee: **Blu Dot Design & Manufacturing, Inc.**, Minneapolis, MN (US)
(**) Term: **15 Years**

D283,572 S * 4/1986 Harig D6/661
4,692,984 A 9/1987 McKernan et al.
D292,458 S * 10/1987 Doezema D6/691.8
D293,521 S * 1/1988 Handler D6/657
D293,523 S 1/1988 Handler et al.
D304,980 S 12/1989 Bush et al.
1,908,418 A 5/1993 Guthrie
5,364,178 A 11/1994 Hofman et al.
D427,806 S * 7/2000 Lacroix D6/671.1
D444,313 S 7/2001 Hutton
(Continued)

(21) Appl. No.: **29/625,009**
(22) Filed: **Nov. 6, 2017**
(51) **LOC (12) Cl.** **06-04**
(52) **U.S. Cl.**
USPC **D6/657**
(58) **Field of Classification Search**
USPC D6/407, 657, 661, 663, 664, 664.1,
D6/668.2, 671, 671.1, 671.4, 675, 675.1,
D6/675.5, 683.1, 691.1, 691.8, 691.9,
D6/702, 703; D14/168, 184; D15/85
CPC ... A47B 47/024; A47B 87/008; A47B 87/002;
A47B 88/48; A47B 88/90; A47F 3/0413;
A47F 5/116; A47F 5/0018; A47F 9/00;
Y10T 428/24694; F25D 21/14; F25D
23/069; F25D 2400/10
See application file for complete search history.

OTHER PUBLICATIONS

Blu Dot Catalog No. 16, Designed in Minneapolis, Minnesota,
Copyright 2015, 44 pages.
(Continued)

Primary Examiner — Kevin K Rudzinski
Assistant Examiner — Paul D Bohannon
(74) *Attorney, Agent, or Firm* — Fredrikson & Byron,
P.A.

(57) **CLAIM**

I claim the ornamental design for a console, as shown and described.

DESCRIPTION

FIG. 1 is an upper front right perspective view of a console of Applicant's design;
FIG. 2 is a front elevational view thereof;
FIG. 3 is a rear elevational view thereof;
FIG. 4 is a top plan view thereof;
FIG. 5 is a bottom plan view thereof;
FIG. 6 is a right-side elevational view thereof, the left-side elevational view being a mirror image thereof; and,
FIG. 7 is a sectional view taken along line 7-7 of FIG. 2.
Where included, broken lines showing environment or structure are for illustrative purposes only and form no part of the claimed design.

(56) **References Cited**
U.S. PATENT DOCUMENTS

D165,088 S * 11/1951 Moelgin D23/328
D193,516 S 9/1962 Deaton
D220,442 S * 4/1971 Beavers D6/671
D234,386 S * 2/1975 Hodges D6/671.1
D242,101 S 11/1976 Stirling
D243,908 S * 4/1977 Neff D30/104
D249,429 S * 9/1978 Robinson D6/671
D255,519 S 6/1980 Friedman
D256,305 S 8/1980 Johnson
D258,256 S 2/1981 Brown

1 Claim, 6 Drawing Sheets

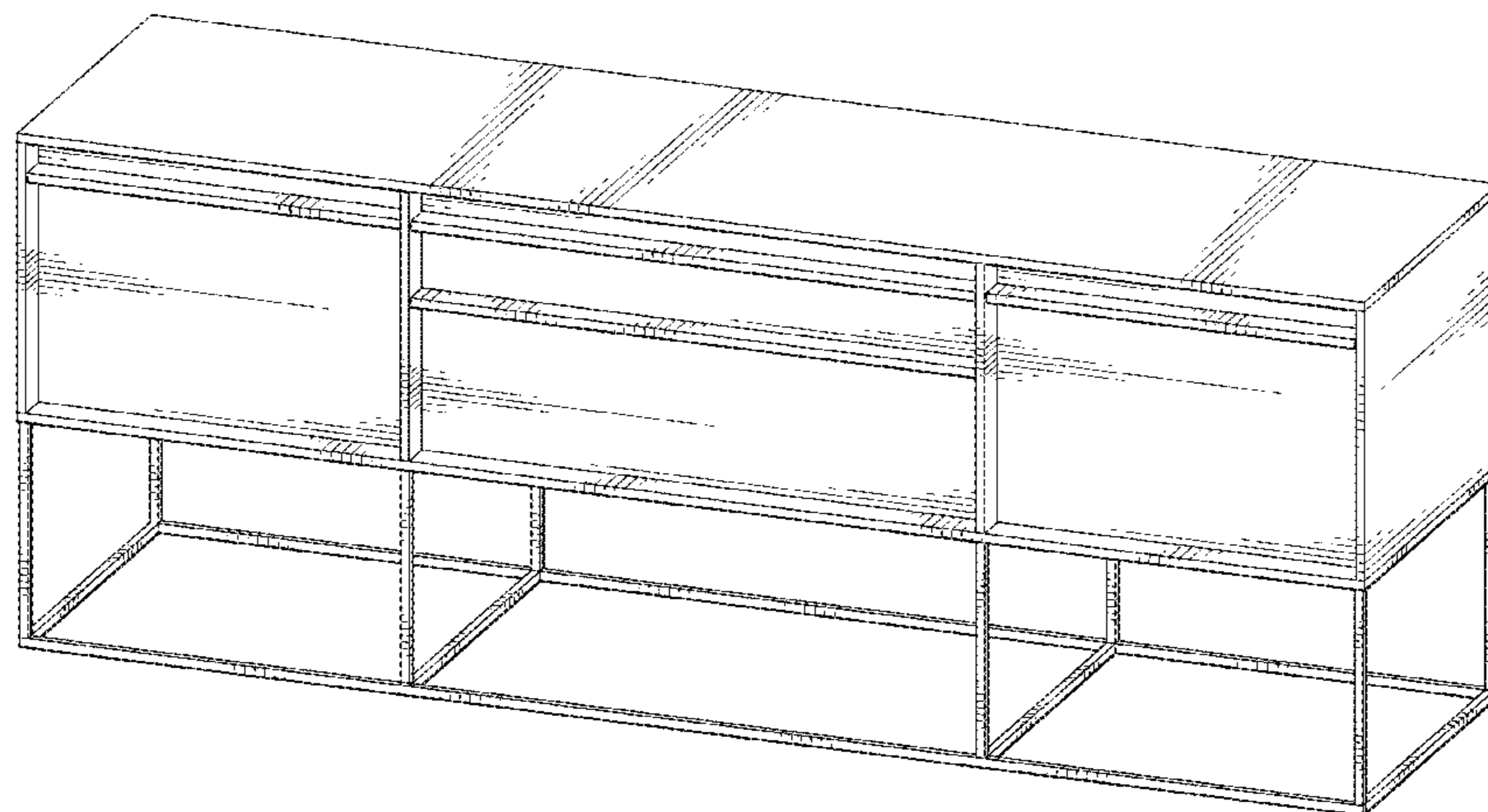

(56)

References Cited

U.S. PATENT DOCUMENTS

D452,624 S * 1/2002 de Blois D6/691.9
 D485,709 S * 1/2004 de Blois D6/675
 D499,274 S * 12/2004 Juneau D6/657
 D501,736 S 2/2005 Kirkpatrick
 D513,678 S 1/2006 Henriott et al.
 D517,346 S 3/2006 Boudreau
 D519,299 S * 4/2006 Boudreau D6/657
 D519,750 S * 5/2006 Boudreau D6/671.4
 D529,316 S * 10/2006 Fujiki D6/675
 D532,624 S * 11/2006 Juneau D6/657
 D567,536 S * 4/2008 Paterson D6/657
 D588,831 S 3/2009 Mohundro
 D596,422 S 7/2009 Hoshino
 D596,874 S 7/2009 Martin et al.
 D598,672 S * 8/2009 Maly D6/671.1
 D611,735 S * 3/2010 Stukenberg D6/691.8
 D614,888 S 5/2010 Sexton
 D616,226 S * 5/2010 Calco D6/675.1
 D622,976 S * 9/2010 Lovegrove D6/671.1
 D637,834 S * 5/2011 Lewis D6/671.1
 D644,853 S * 9/2011 Becker D6/661
 D669,704 S * 10/2012 Zambelli D6/657
 D718,955 S * 12/2014 Helser D6/657
 D722,451 S 2/2015 Chen
 D728,280 S * 5/2015 Weatherly D6/671.1
 D734,071 S 7/2015 Zhao
 D742,667 S * 11/2015 Weatherly D6/671.1
 D743,721 S * 11/2015 Weatherly D6/671.1
 D752,905 S * 4/2016 Healy D6/657

D770,815 S 11/2016 Jackson et al.
 D771,415 S * 11/2016 Chen D6/657
 D777,304 S * 1/2017 Esteve D23/286
 D790,883 S 7/2017 Schonherr et al.
 D793,776 S * 8/2017 Davis D6/675
 D815,464 S * 4/2018 Caillouet D6/657
 D824,703 S * 8/2018 Yamamoto D6/675.1
 D825,229 S * 8/2018 Massaud D6/675
 D825,232 S * 8/2018 Massaud D6/675.1
 D836,365 S * 12/2018 Chong D6/657
 D848,770 S 5/2019 Davis et al.

OTHER PUBLICATIONS

Blu Dot Catalog No. 17, Designed in Minneapolis, Minnesota, Copyright 2015, 52 pages.
 Blu Dot Catalog No. 18, Designed in Minneapolis, Minnesota, Copyright 2015, 51 pages.
 Blu Dot Catalog No. 19, Designed in Minneapolis, Minnesota, Copyright 2016, 54 pages.
 West Elm. <https://www.westelm.com/products/logan-5-drawer-dresser-natural-h2025/?pkey=clogan-collection&isx=O.O>. "Logan Industrial 5-Drawer Dresser". Date unknown: Viewed Jun. 2019 (Year: 2019).
 West Elm; <https://westelm.com/products/logan-6-drawer-dresser-natural-h2026/?pkey=clogan-collection&isx=O.O>. "Logan Industrial 6-Drawer Dresser". Date unknown: Viewed Jun. 2019 (Year: 2019).

* cited by examiner

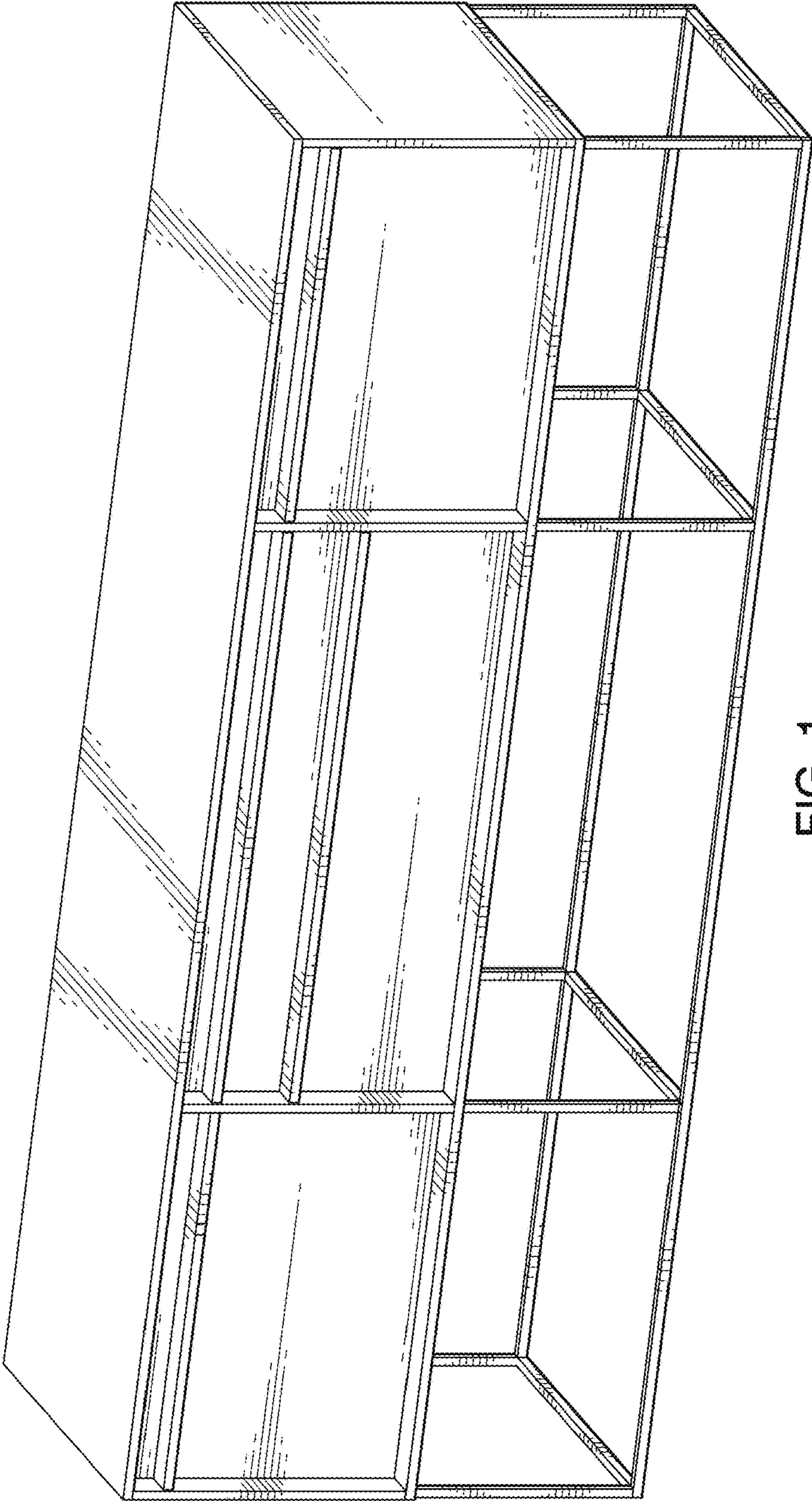

FIG. 1

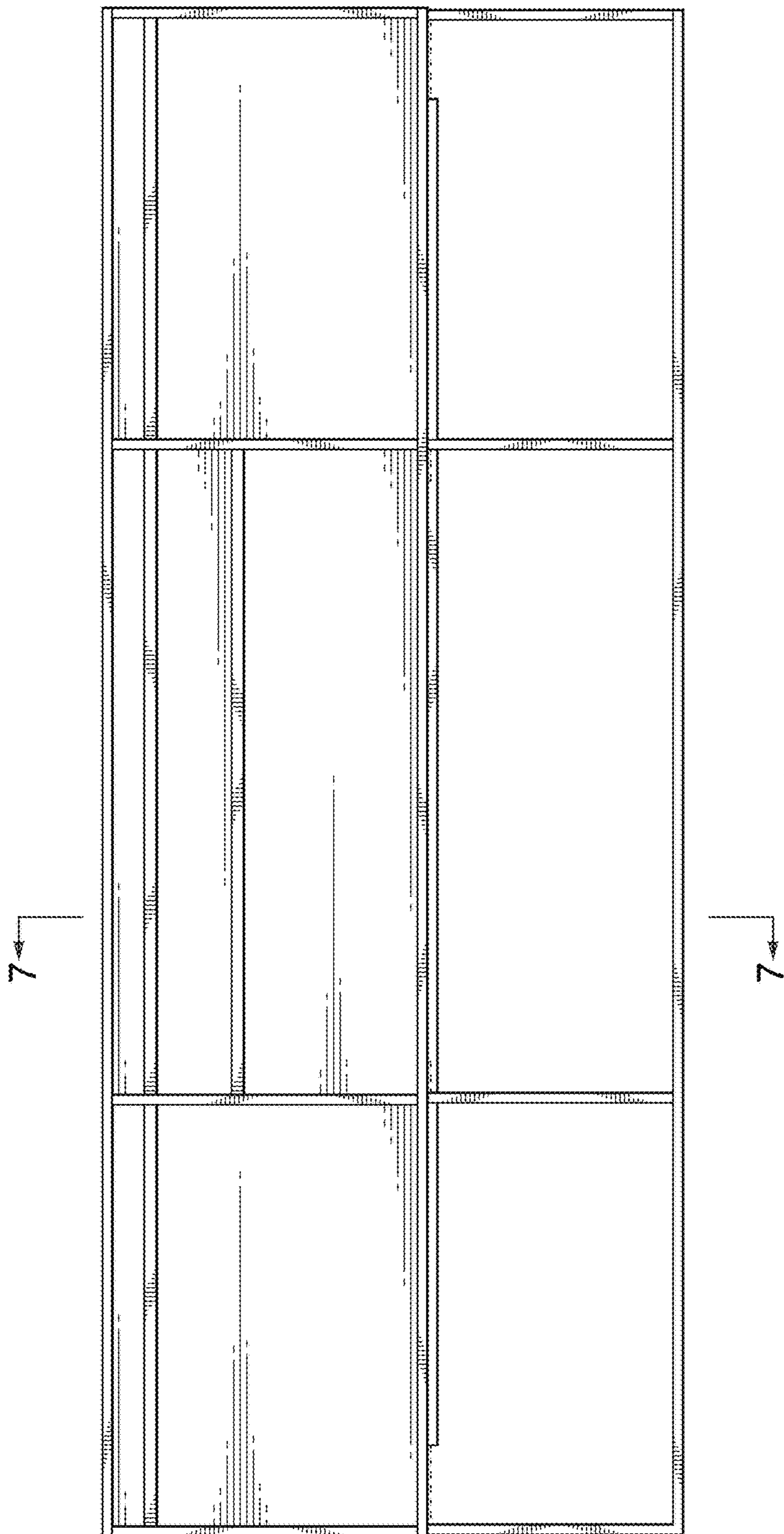

FIG. 2

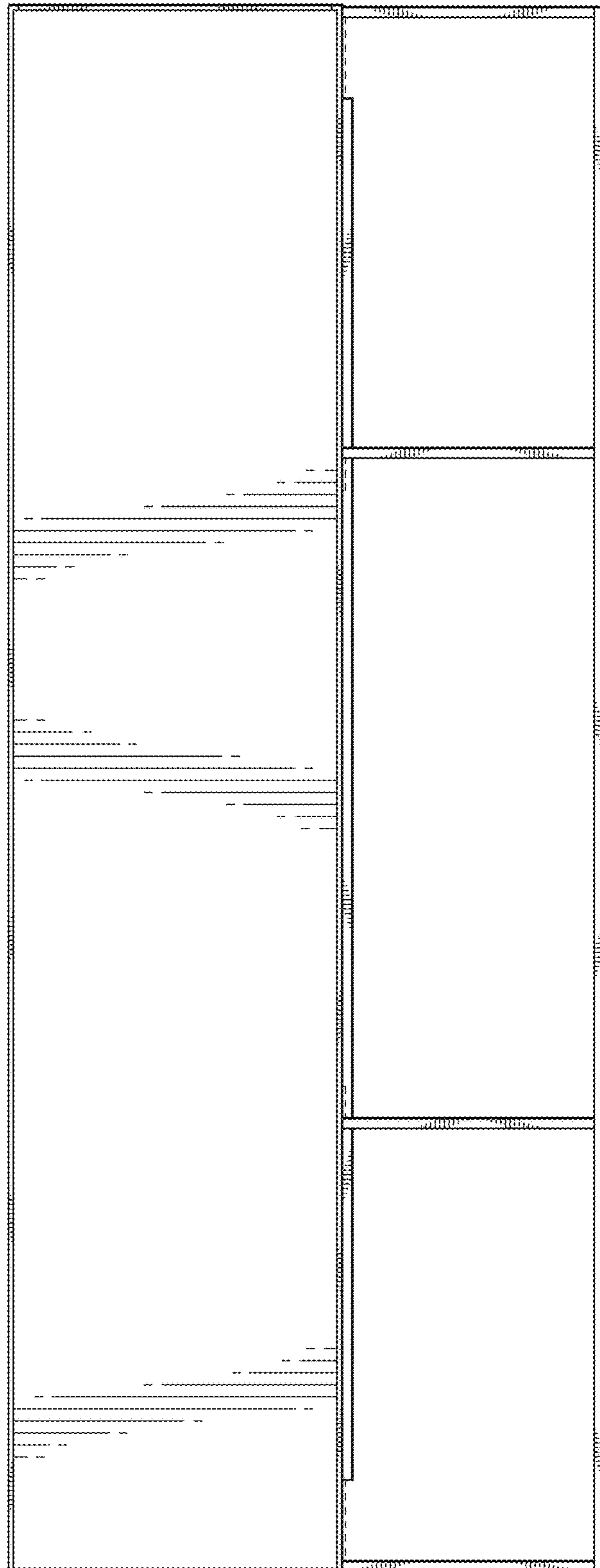

FIG. 3

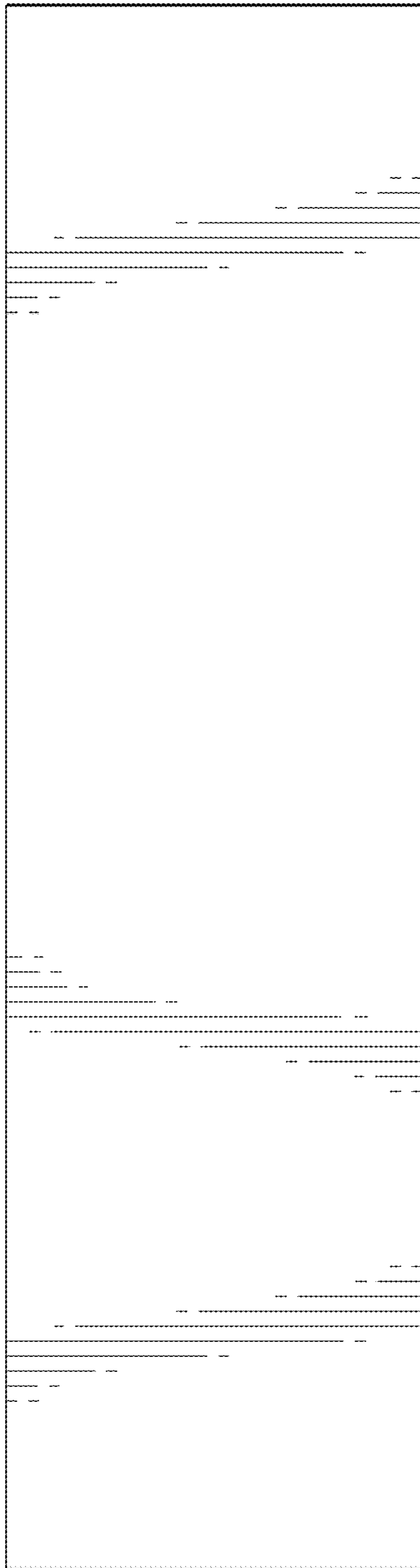

FIG. 4

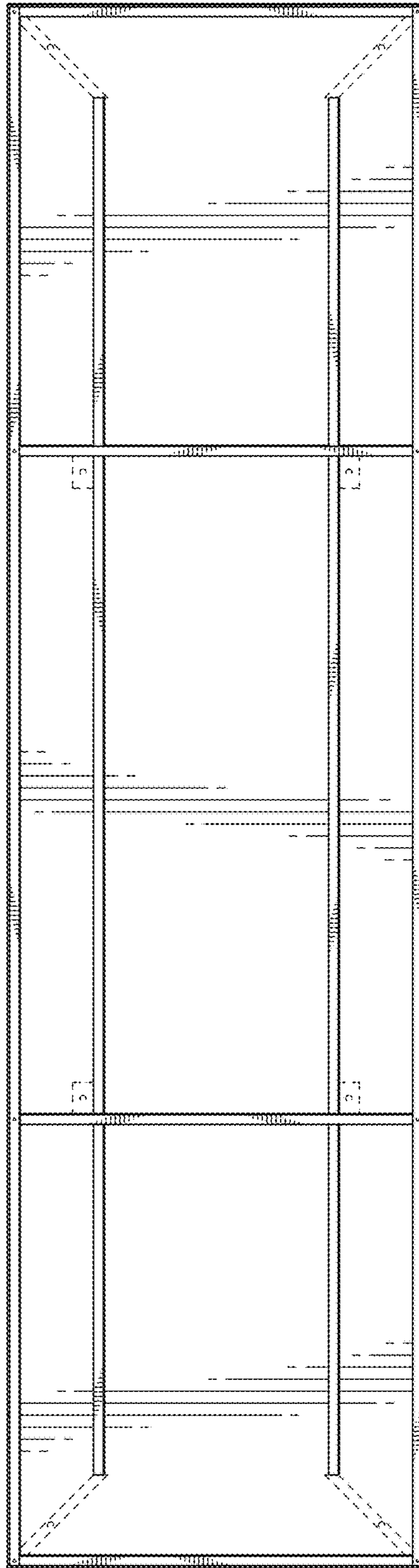

FIG. 5

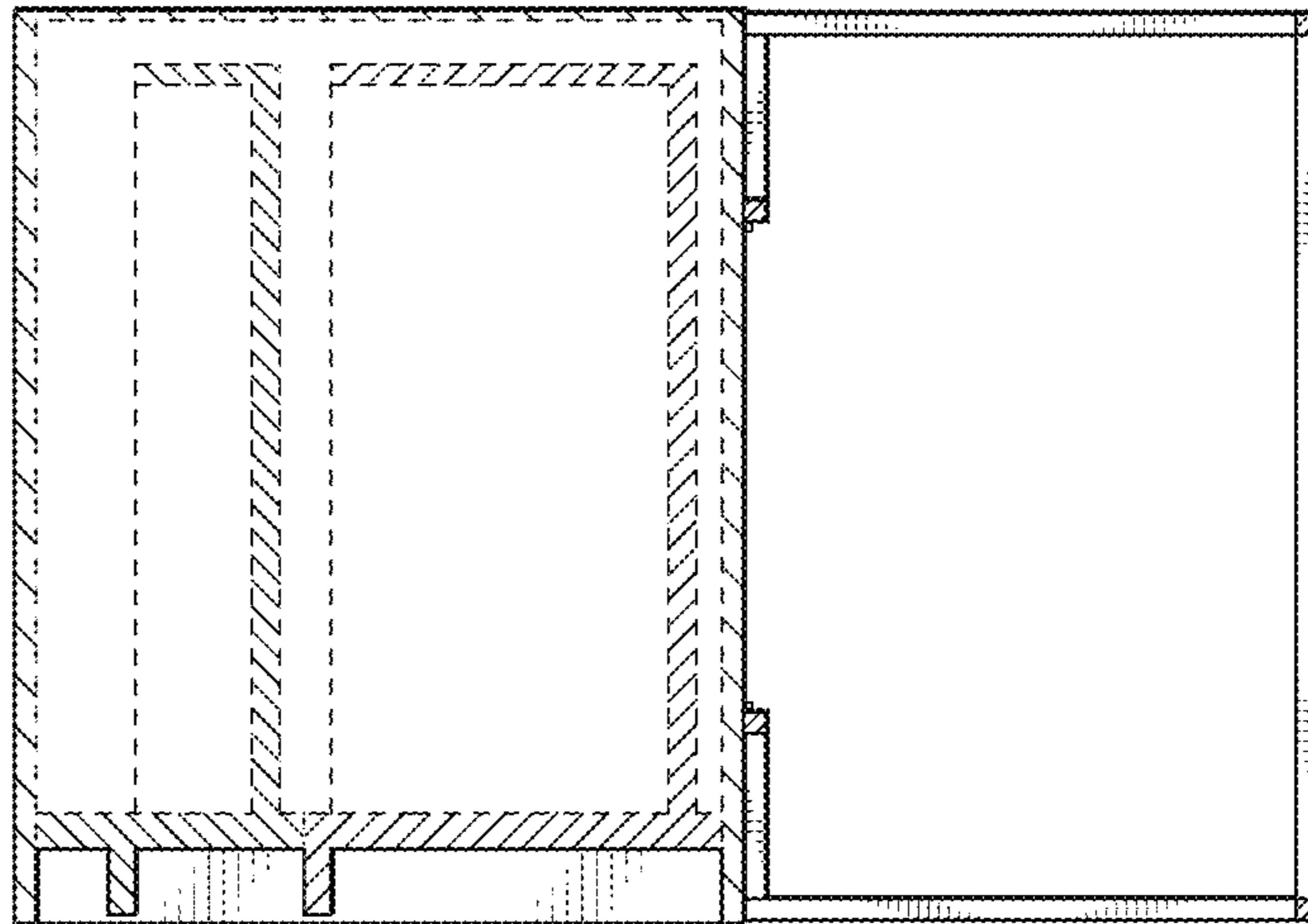

FIG. 7

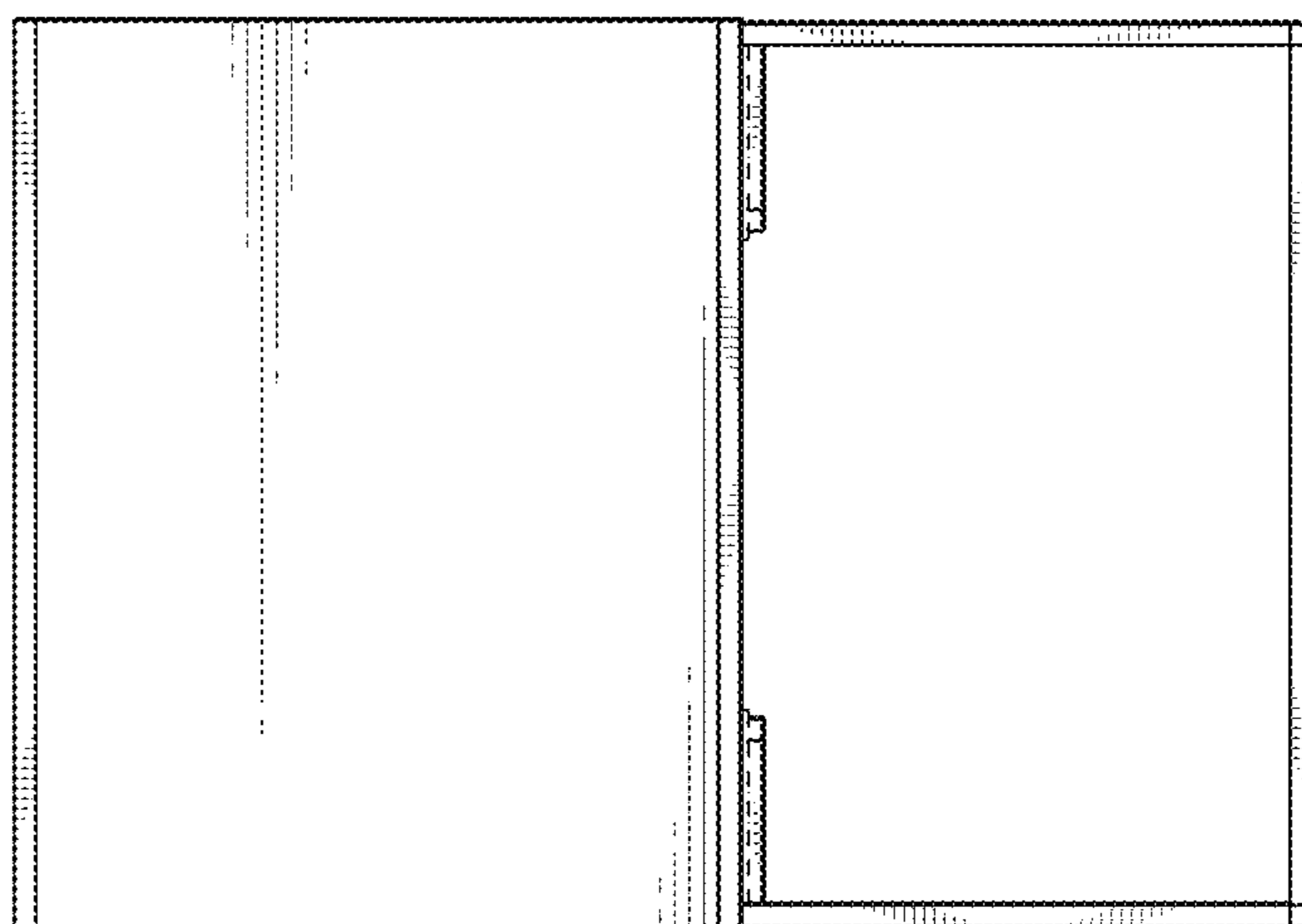

FIG. 6