



US00D870367S

(12) **United States Design Patent** (10) **Patent No.:** **US D870,367 S**  
**Chung et al.** (45) **Date of Patent:** **\*\* Dec. 17, 2019**

(54) **LIGHTER/EXTINGUISHER FOR HEATED TOBACCO STICKS**

(71) Applicant: **PHILIP MORRIS PRODUCTS S.A.**,  
Neuchâtel (CH)

(72) Inventors: **Kyungil Chung**, Glenageary (IE);  
**Florent Cuchet**, Stockholm (SE);  
**Philip Nilsson**, Bray (IE)

(73) Assignee: **PHILIP MORRIS PRODUCTS S.A.**,  
Neuchâtel (CH)

(\*\*) Term: **15 Years**

(21) Appl. No.: **35/504,881**

(22) Filed: **Nov. 8, 2017**

(80) **Hague Agreement Data**

Int. Filing Date: **Nov. 8, 2017**

Int. Reg. No.: **DM/099988**

Int. Reg. Date: **Nov. 8, 2017**

Int. Reg. Pub. Date: **May 11, 2018**

(30) **Foreign Application Priority Data**

May 26, 2017 (EM) ..... 004020394-0001

May 26, 2017 (EM) ..... 004020394-0002

May 26, 2017 (EM) ..... 004020394-0004

(51) **LOC (12) Cl.** ..... **27-05**

(52) **U.S. Cl.**  
USPC ..... **D27/141**

(58) **Field of Classification Search**  
USPC ..... D27/141-163, 172-194  
CPC ..... A24F 47/00; A24F 47/008; H05B 3/03;  
A61M 16/108; A61M 16/10  
See application file for complete search history.

(56) **References Cited**

U.S. PATENT DOCUMENTS

D284,113 S \* 6/1986 Wassmann ..... D27/159

D377,235 S \* 1/1997 Inoue ..... D27/141

D493,912 S \* 8/2004 Wong ..... D27/141  
D494,313 S \* 8/2004 Wong ..... D27/141  
D502,285 S \* 2/2005 Tufts, Jr. .... D27/141  
D527,140 S \* 8/2006 Harel ..... D27/141  
D664,709 S 7/2012 Almsberger et al.  
D693,055 S \* 11/2013 Manca ..... D27/189  
D700,397 S \* 2/2014 Manca ..... D27/189  
D700,738 S \* 3/2014 Rennick ..... D27/189  
D736,995 S \* 8/2015 Recio ..... D27/141  
D754,913 S 4/2016 Almsberger et al.  
D760,428 S \* 6/2016 Rahbar ..... D27/141  
D790,455 S \* 6/2017 McGarry ..... D13/107  
D807,575 S \* 1/2018 Luo ..... D27/141  
D828,950 S \* 9/2018 Gu ..... D27/141  
D833,671 S \* 11/2018 Stephane ..... D27/141

FOREIGN PATENT DOCUMENTS

TW D112686 8/2006

OTHER PUBLICATIONS

Combined Notice of Allowance and Search Report dated Mar. 29, 2019 in Taiwanese Patent Application No. 106306700 (with English translation), citing documents AA, AB and AO therein, 5 pages.

\* cited by examiner

*Primary Examiner* — Natasha Vujcic  
(74) *Attorney, Agent, or Firm* — Oblon, McClelland,  
Maier & Neustadt, L.L.P.

(57) **CLAIM**

The ornamental design for a lighter/extinguisher for heated tobacco sticks, as shown and described.

**DESCRIPTION**

1. Lighter/extinguisher for heated tobacco sticks  
Design 1 : lighter/extinguisher for heated tobacco sticks, in particular for those with carbon heat sources; fig. 1.1 perspective view, fig. 1.2 front view, fig. 1.3 rear view, fig. 1.4 left side view, fig. 1.5 right side view, fig. 1.6 top view, and fig. 1.7 bottom view.

**1 Claim, 7 Drawing Sheets**

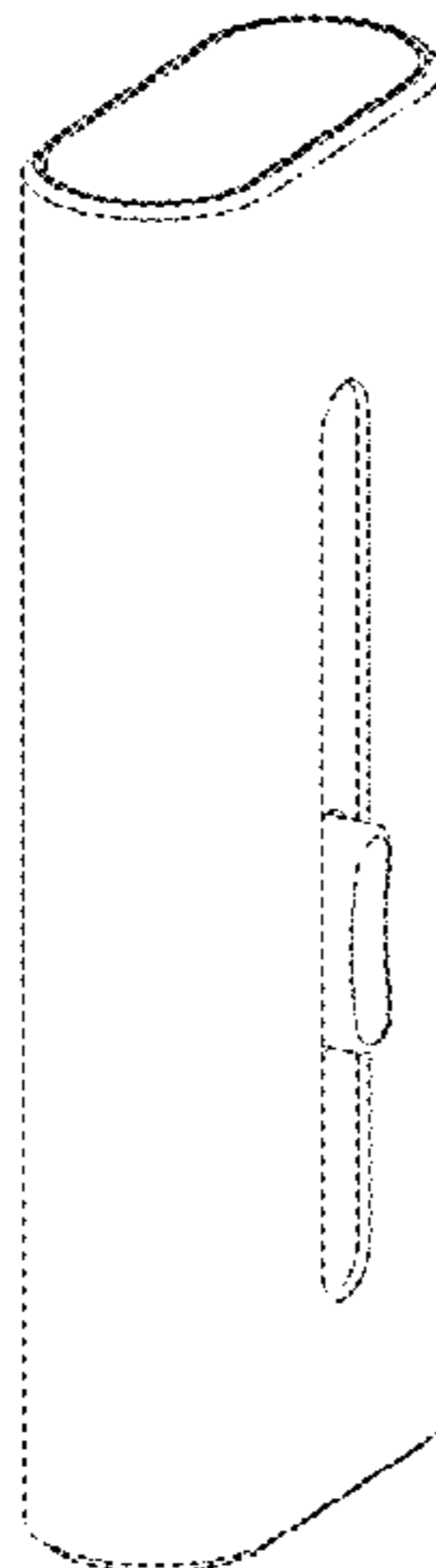

1.1

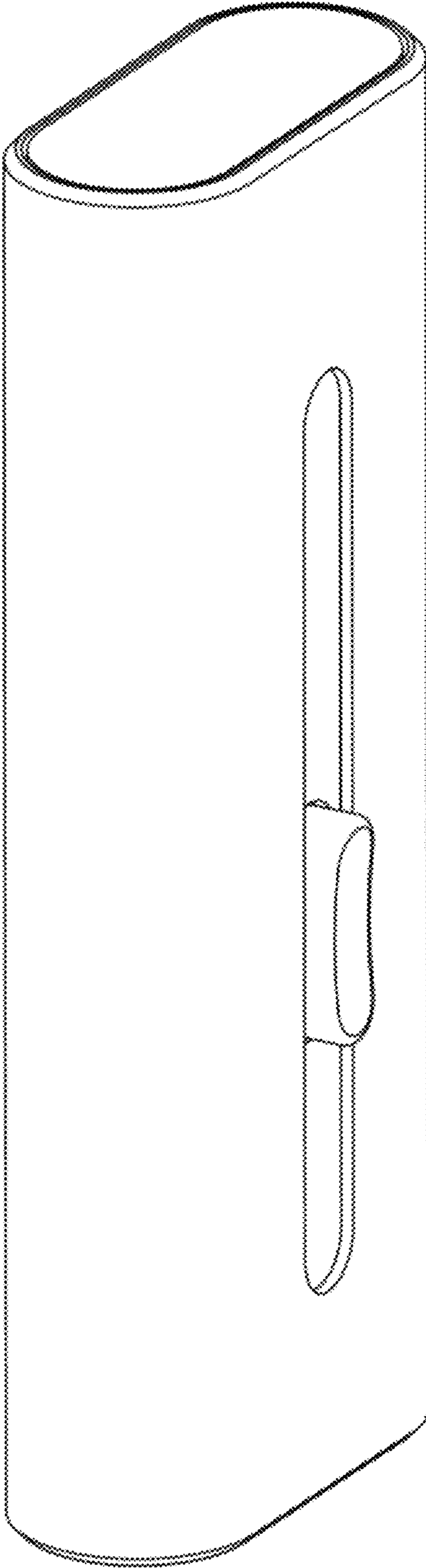

1.2

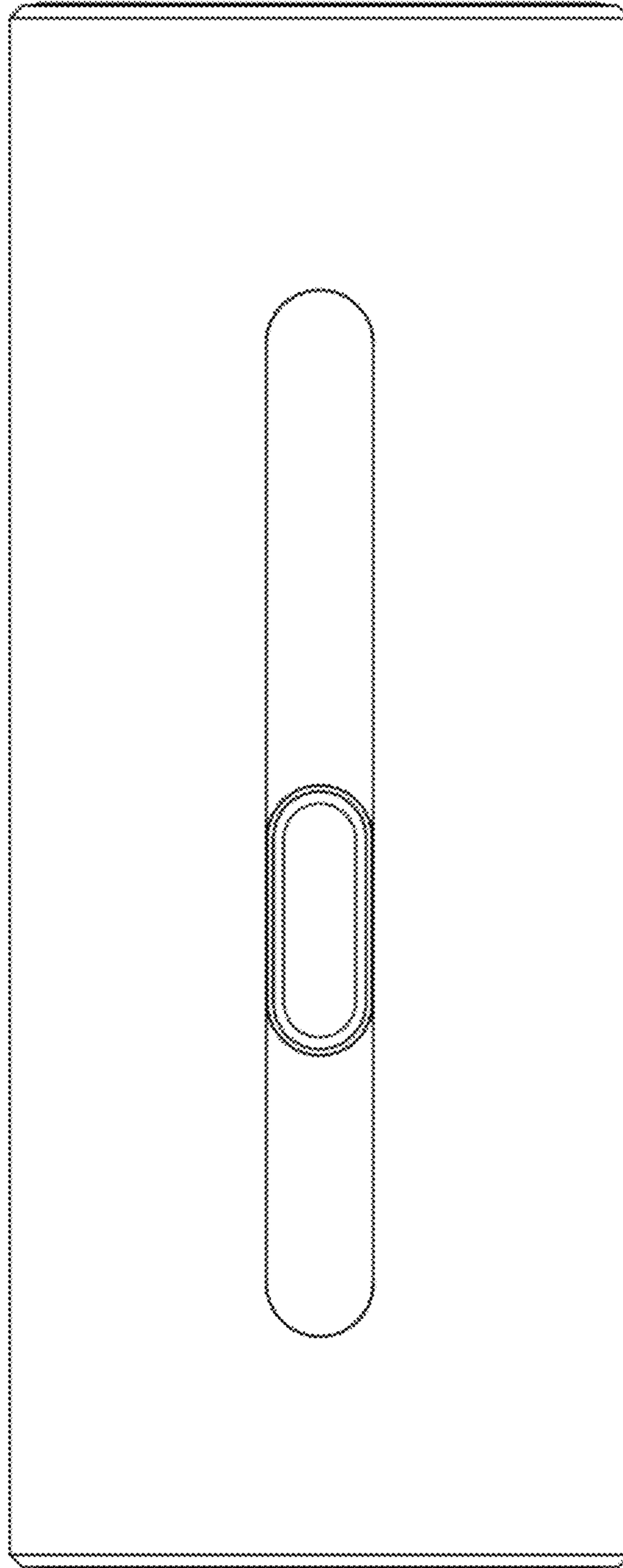

**1.3**

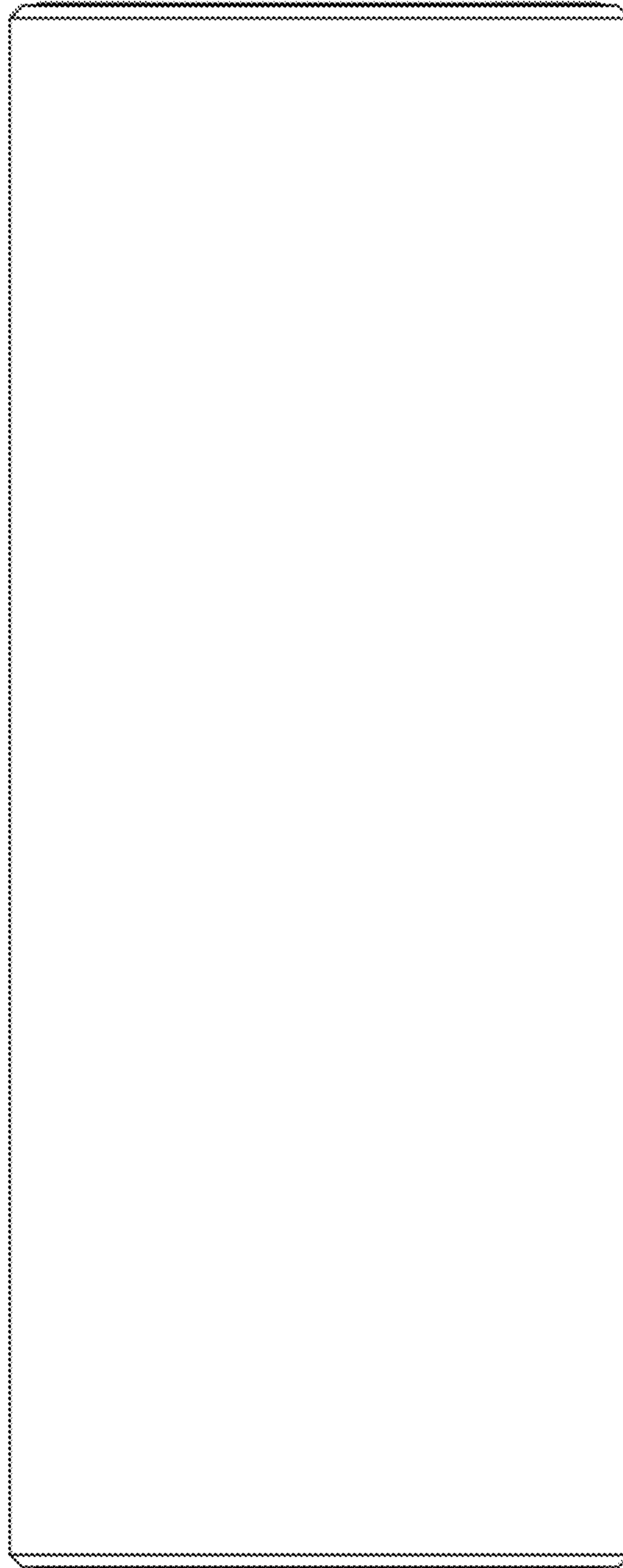

1.4

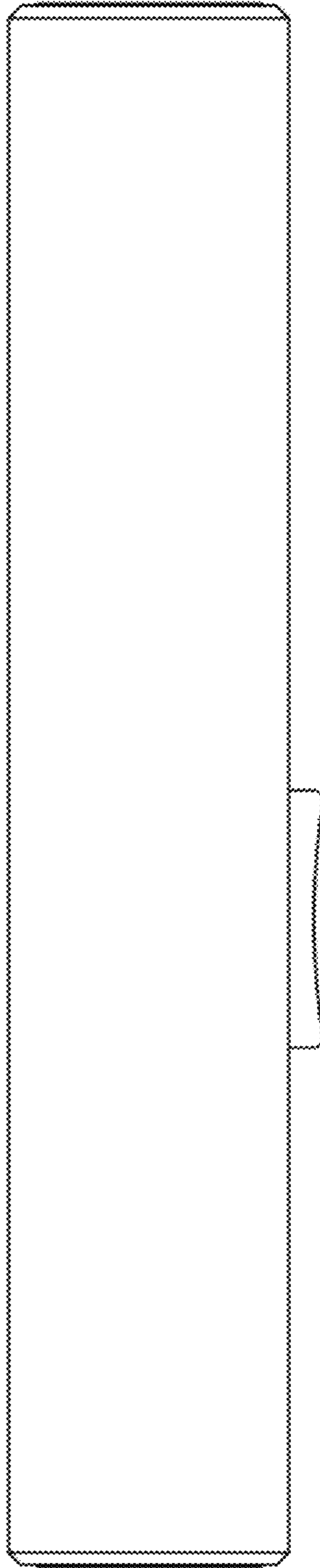

1.5

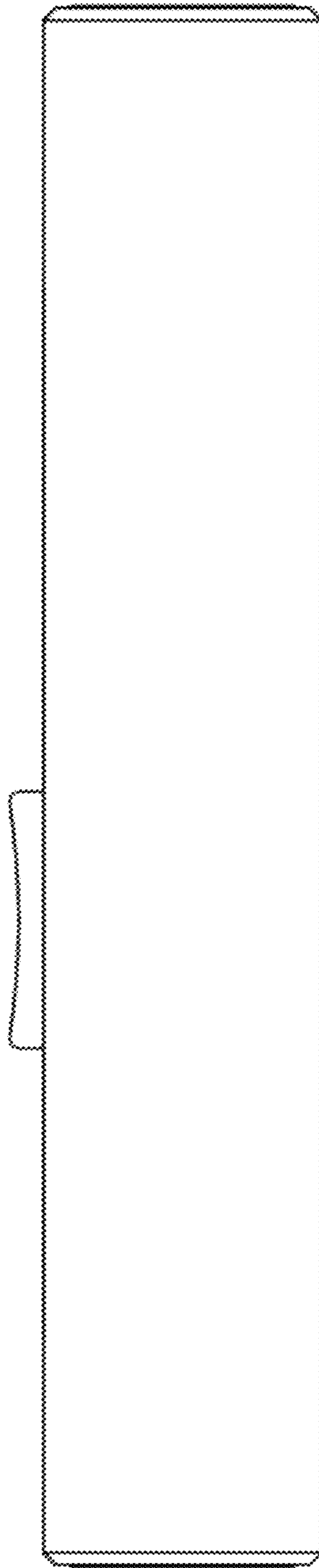

1.6

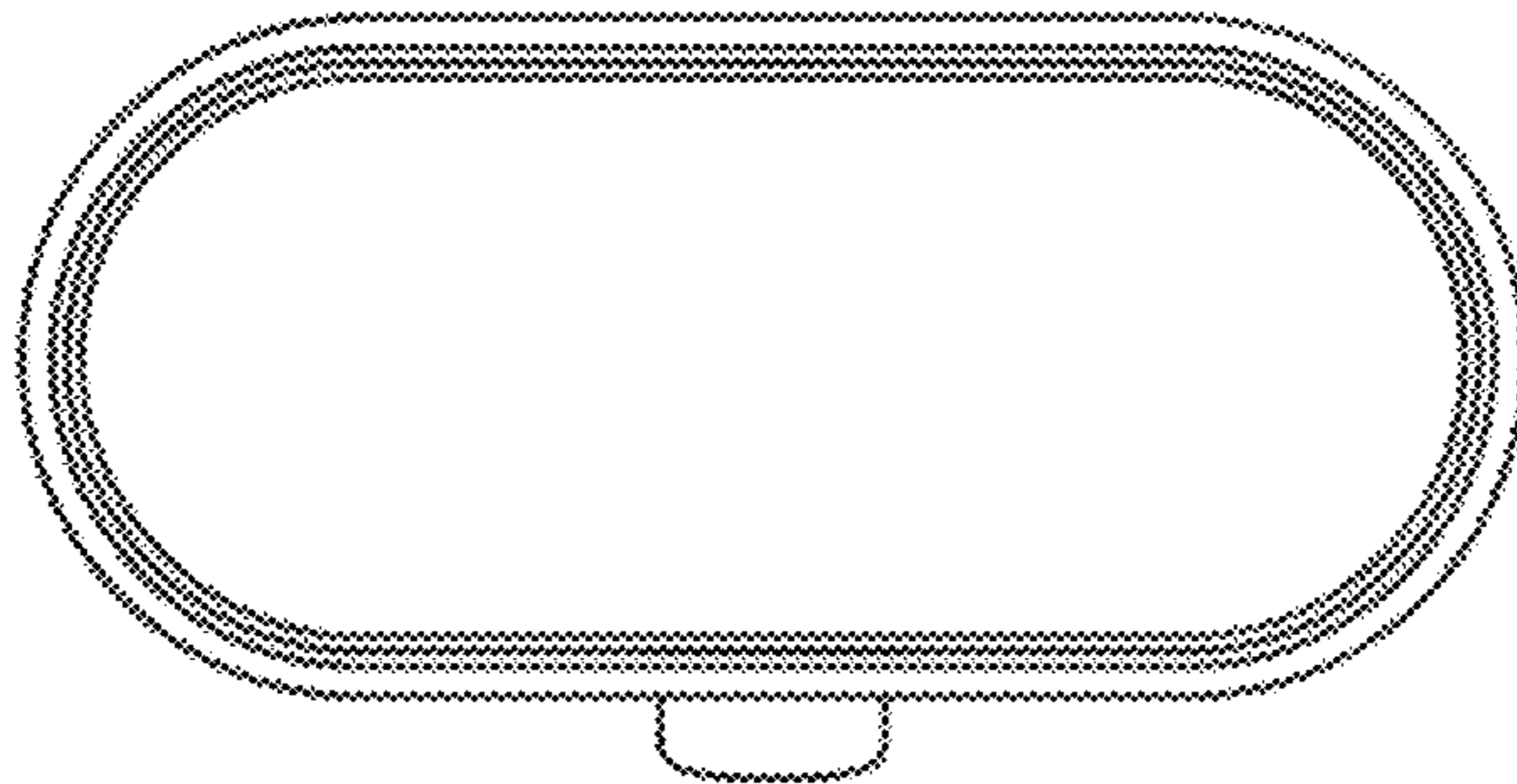

1.7

