



US00D870365S

(12) **United States Design Patent** (10) **Patent No.:** **US D870,365 S**
Sonneman (45) **Date of Patent:** **** Dec. 17, 2019**

(54) **CONNECTOR**

(71) Applicant: **Contemporary Visions, LLC**,
Larchmont, NY (US)

(72) Inventor: **Robert A. Sonneman**, Mamaroneck,
NY (US)

(73) Assignee: **Contemporary Visions, LLC**,
Larchmont, NY (US)

(**) Term: **15 Years**

(21) Appl. No.: **29/674,523**

(22) Filed: **Dec. 21, 2018**

(51) **LOC (12) Cl.** **26-05**

(52) **U.S. Cl.**
USPC **D26/138; D26/113**

(58) **Field of Classification Search**
USPC D26/72, 74, 76, 78-83, 85, 86, 88, 90,
D26/93, 111, 113, 118, 119, 120, 121,
D26/122, 138, 139, 140, 141, 142, 152;
D22/142; D21/499, 500
CPC F21S 2/00; F21S 4/00; F21S 4/003; F21S
4/005; F21S 4/006; F21S 4/007; F21S
4/008; F21S 6/00; F21S 8/00; F21S
8/024; F21S 8/026; F21S 8/031; F21S
8/033; F21S 8/035-037; F21S 8/04; F21S
8/043; F21S 8/063
See application file for complete search history.

(56) **References Cited**

U.S. PATENT DOCUMENTS

D414,530 S * 9/1999 Rudy D21/500
D423,607 S * 4/2000 Rudy D21/500
D435,215 S * 12/2000 Guzman D9/422
D480,437 S * 10/2003 Stoneberg D21/499

D532,148 S * 11/2006 Matsui D26/138
D623,344 S * 9/2010 Tsai D26/138
D629,561 S * 12/2010 Kim D26/138
D702,875 S * 4/2014 Klus D25/122
D707,386 S * 6/2014 McKenzie D26/142
D766,497 S * 9/2016 Salomon D26/138
D779,712 S * 2/2017 Sonneman D26/138
D790,762 S * 6/2017 Sonneman D26/138
D791,400 S * 7/2017 Sonneman D26/138
D795,360 S * 8/2017 Ahn D21/499
D819,441 S * 6/2018 Doster D9/432
D829,953 S * 10/2018 Botti D26/74
D855,244 S * 7/2019 Sonneman D26/113
D856,570 S * 8/2019 Sonneman D26/113

* cited by examiner

Primary Examiner — Natasha Vujcic

(74) *Attorney, Agent, or Firm* — Gottlieb, Rackman &
Reisman, P.C.

(57) **CLAIM**

The ornamental design for a connector, as shown and
described.

DESCRIPTION

FIG. 1 is a first perspective view of a connector showing my
new design;
FIG. 2 is a second perspective view thereof;
FIG. 3 is a first side elevational view thereof;
FIG. 4 is a second side elevational view thereof;
FIG. 5 is a third side elevational view thereof;
FIG. 6 is a fourth side elevational view thereof;
FIG. 7 is a top plan view thereof; and,
FIG. 8 is a bottom plan view thereof.

The broken lines shown in the drawings are included for the
purpose of illustrating elements of the connector for lighting
system and form no part of the claimed design.

1 Claim, 5 Drawing Sheets

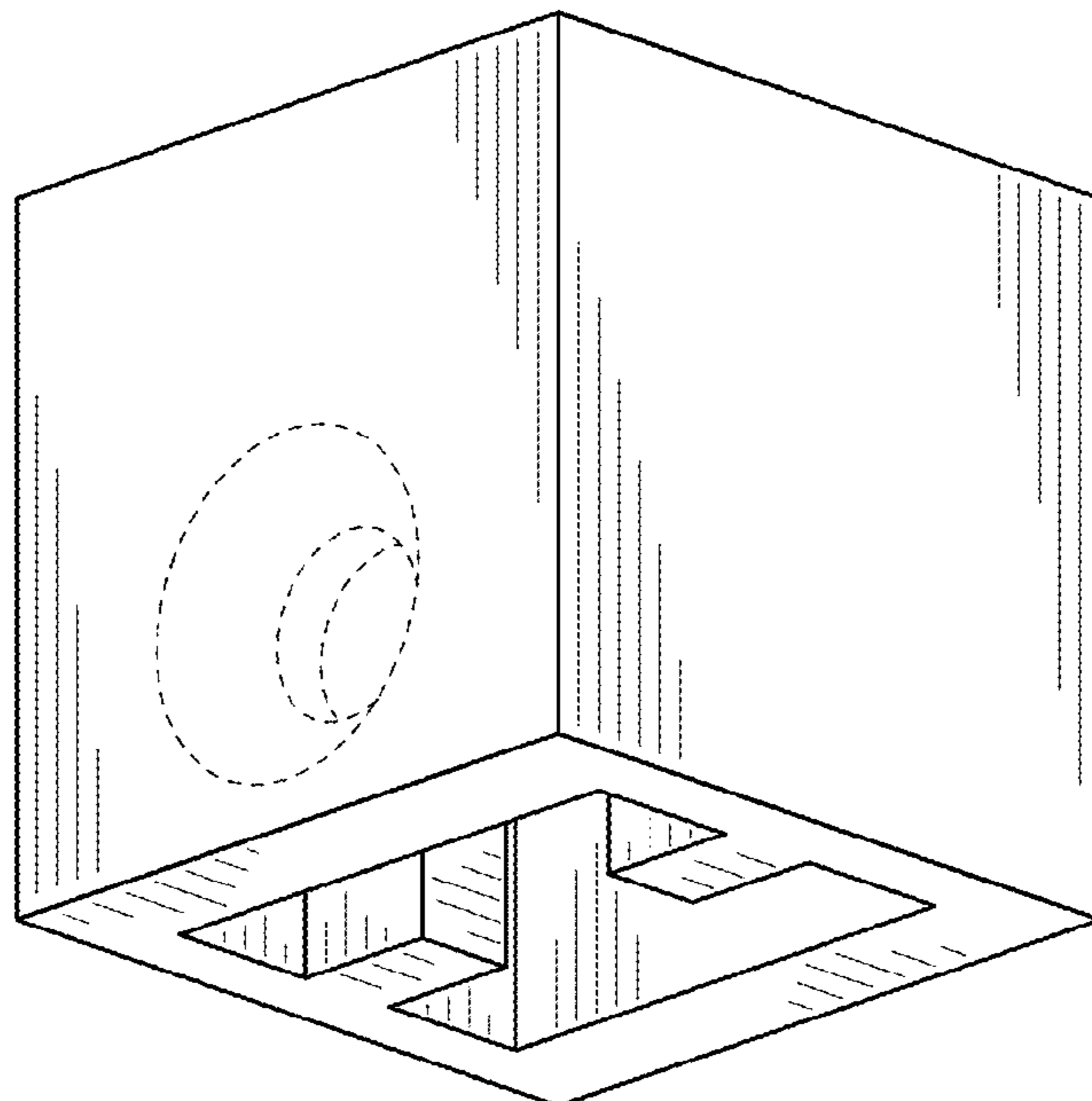

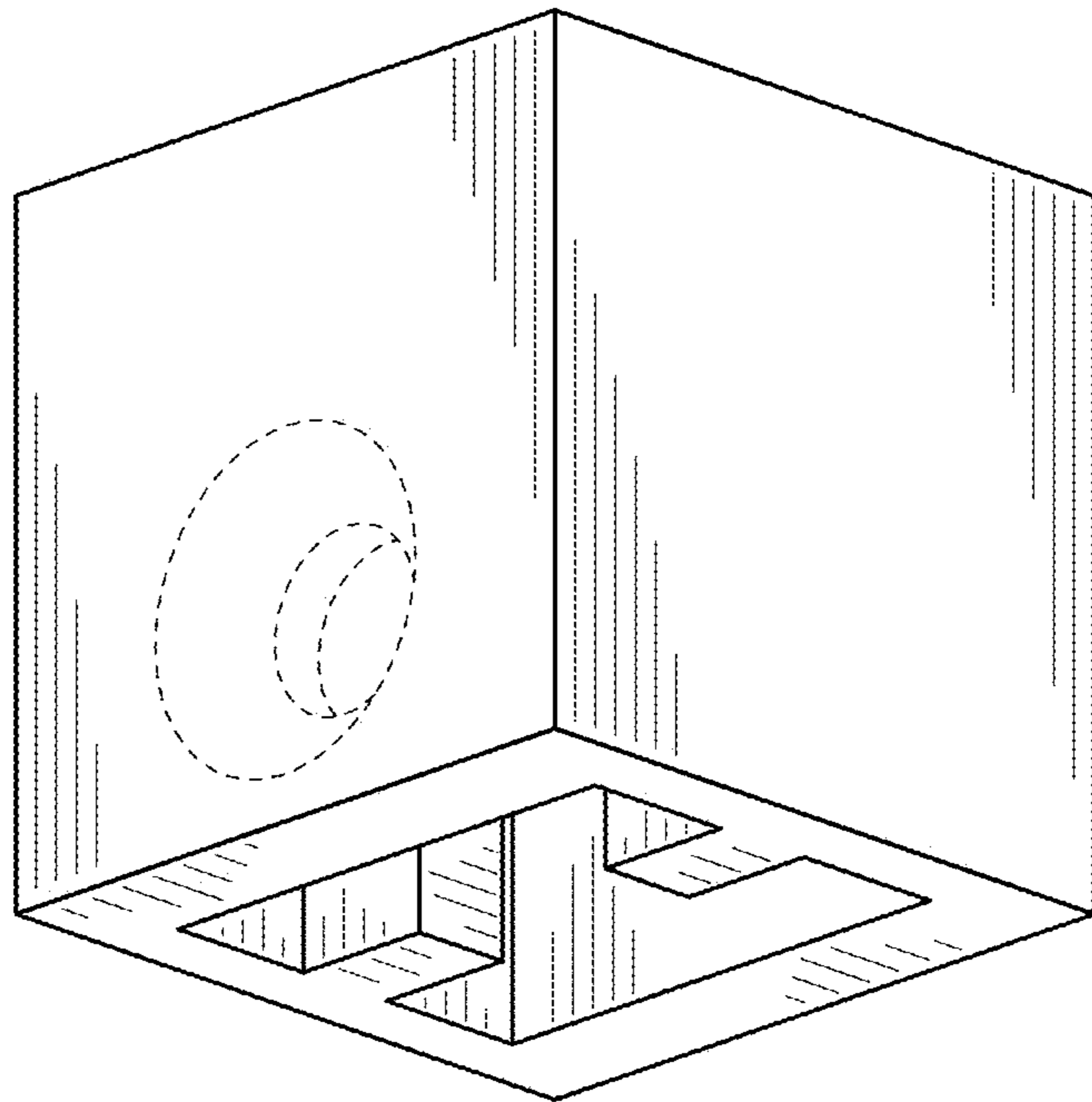

FIG. 1

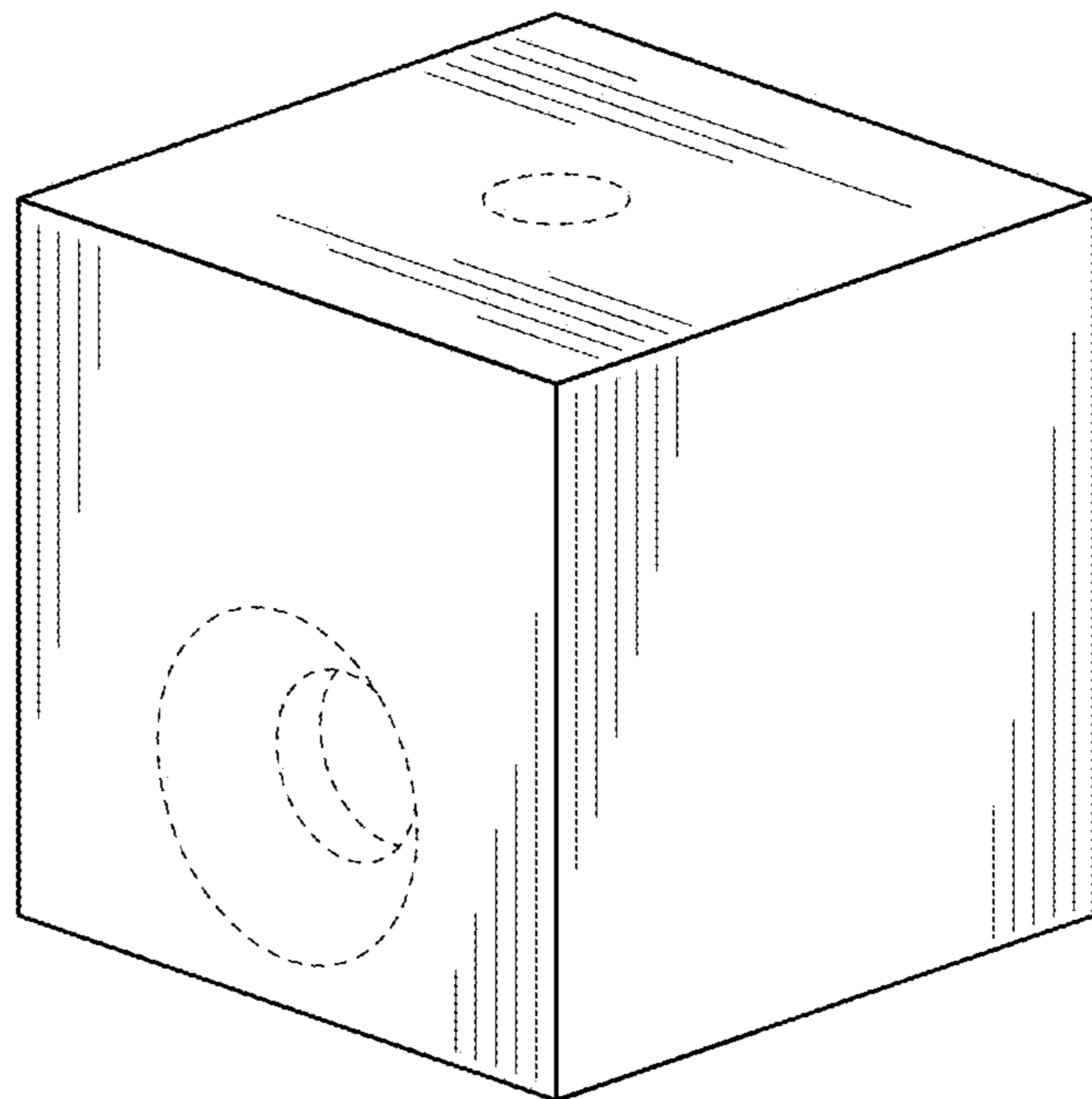

FIG. 2

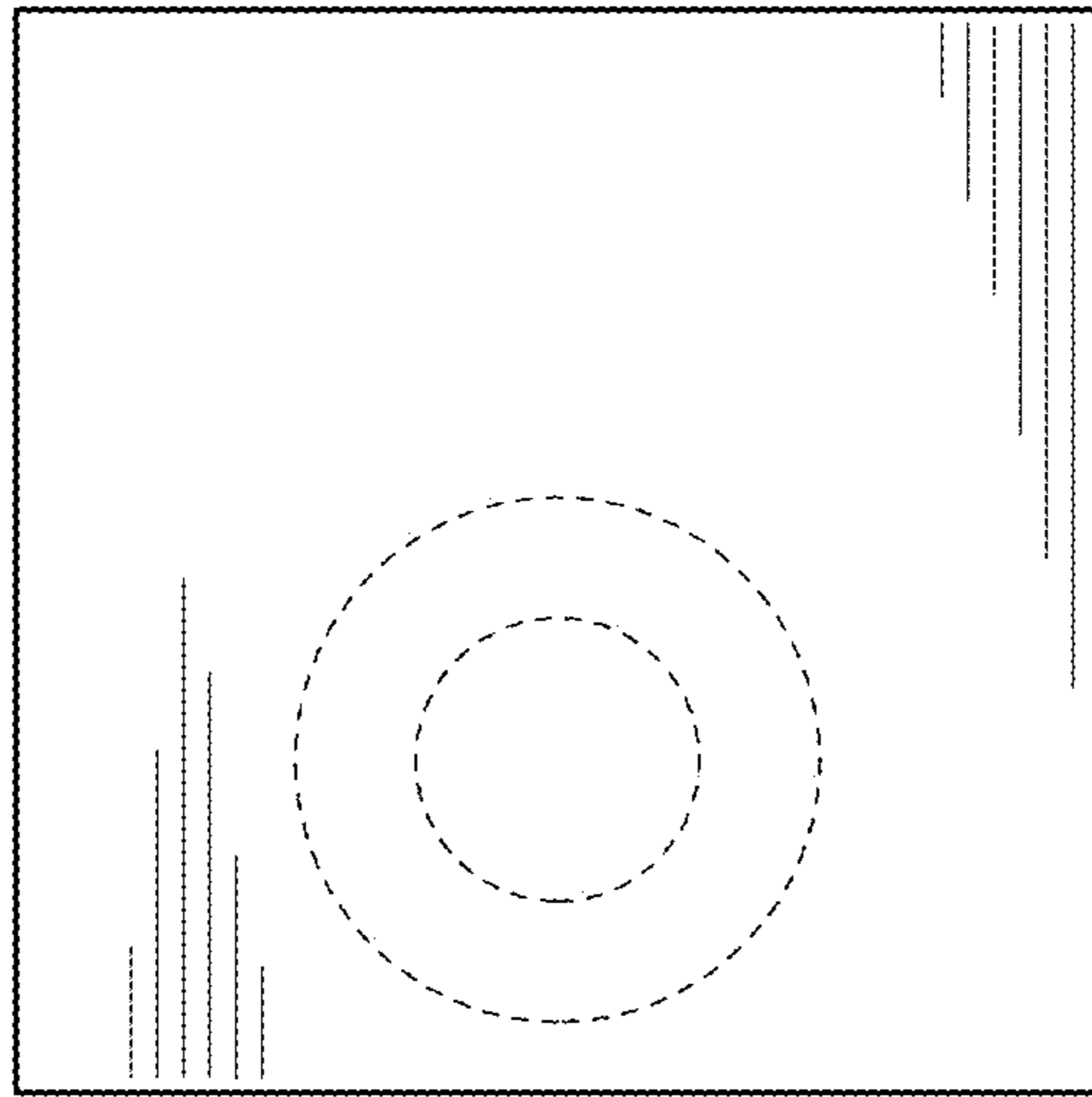

FIG. 3

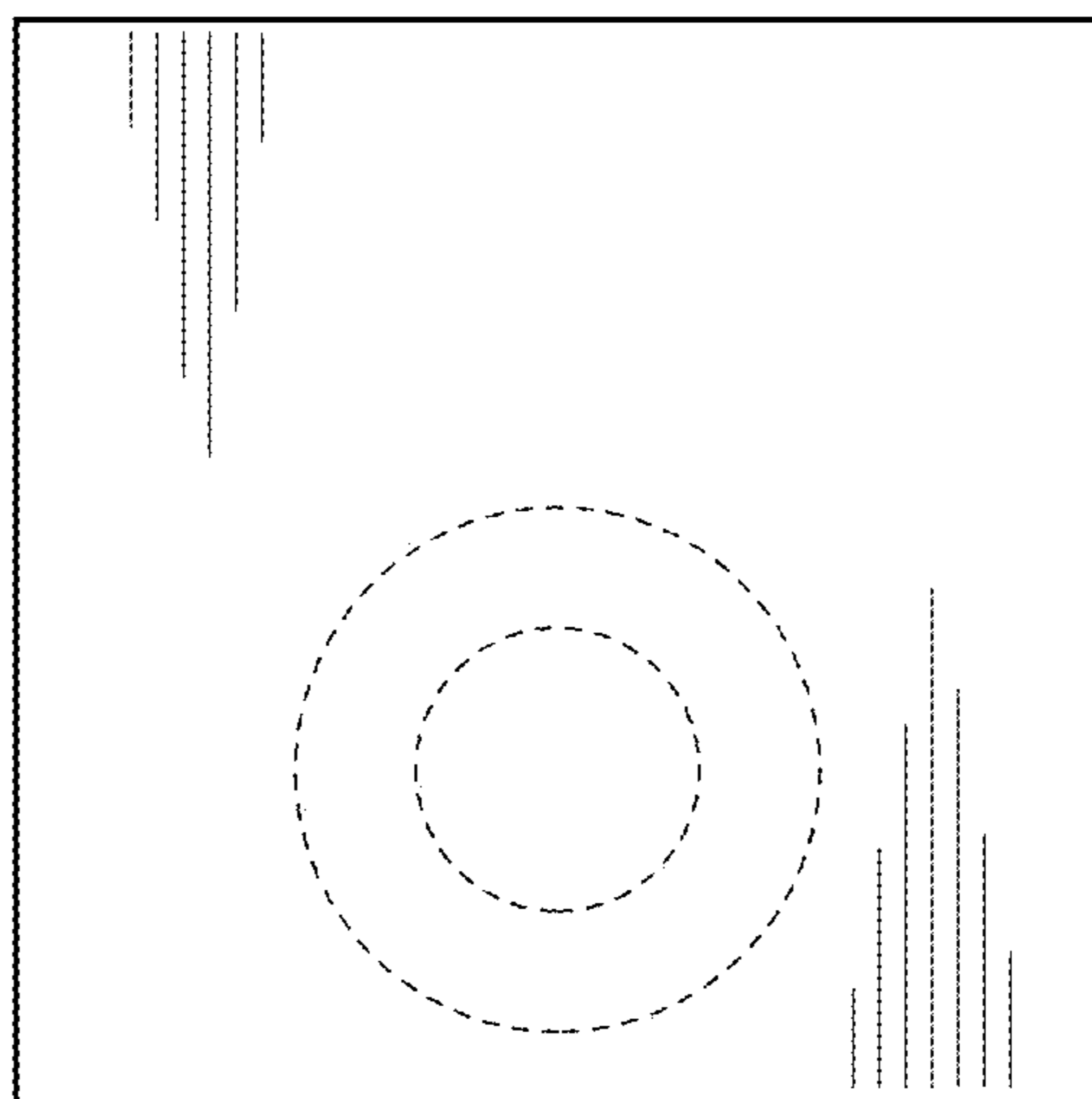

FIG. 4

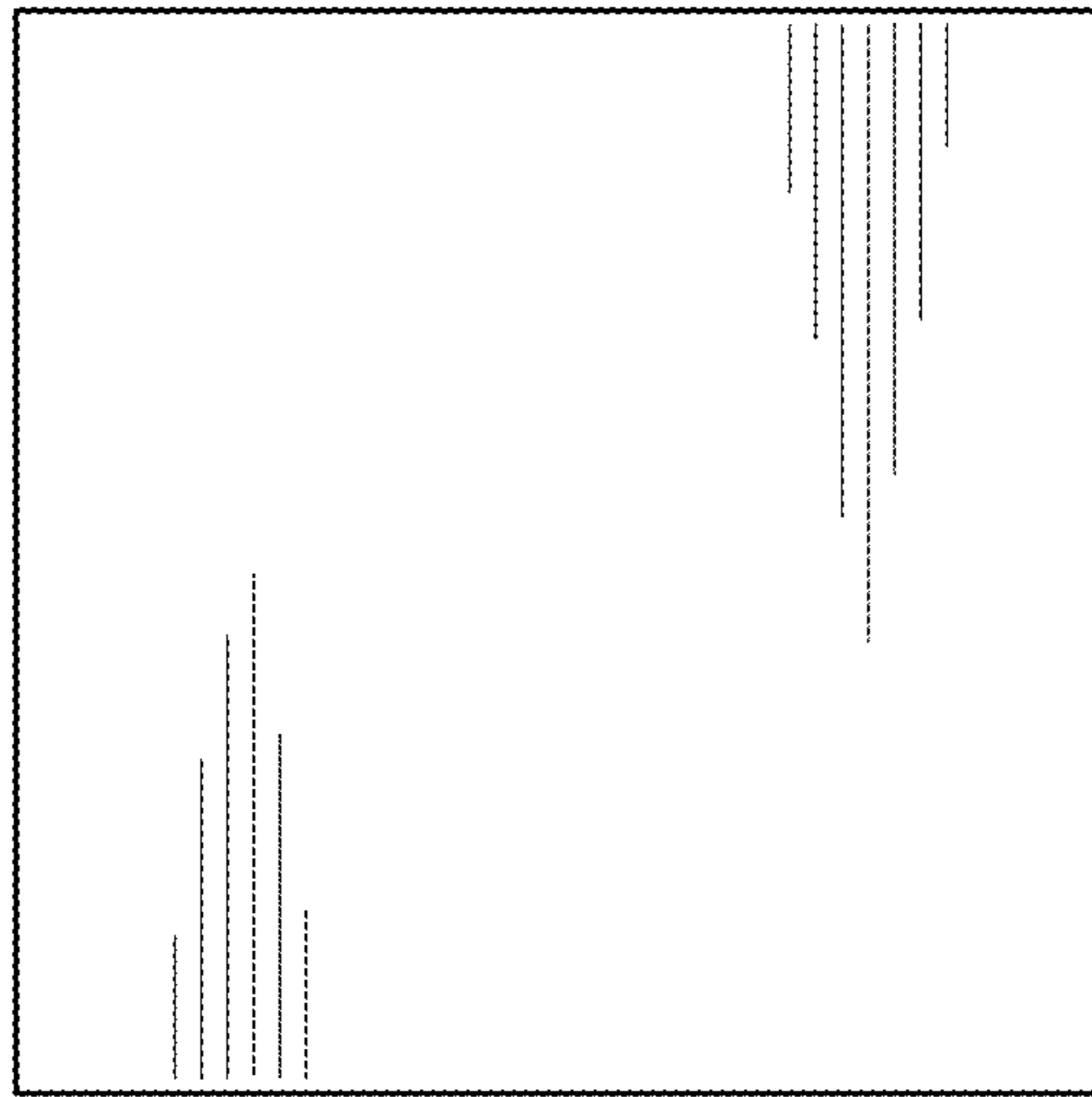

FIG. 5

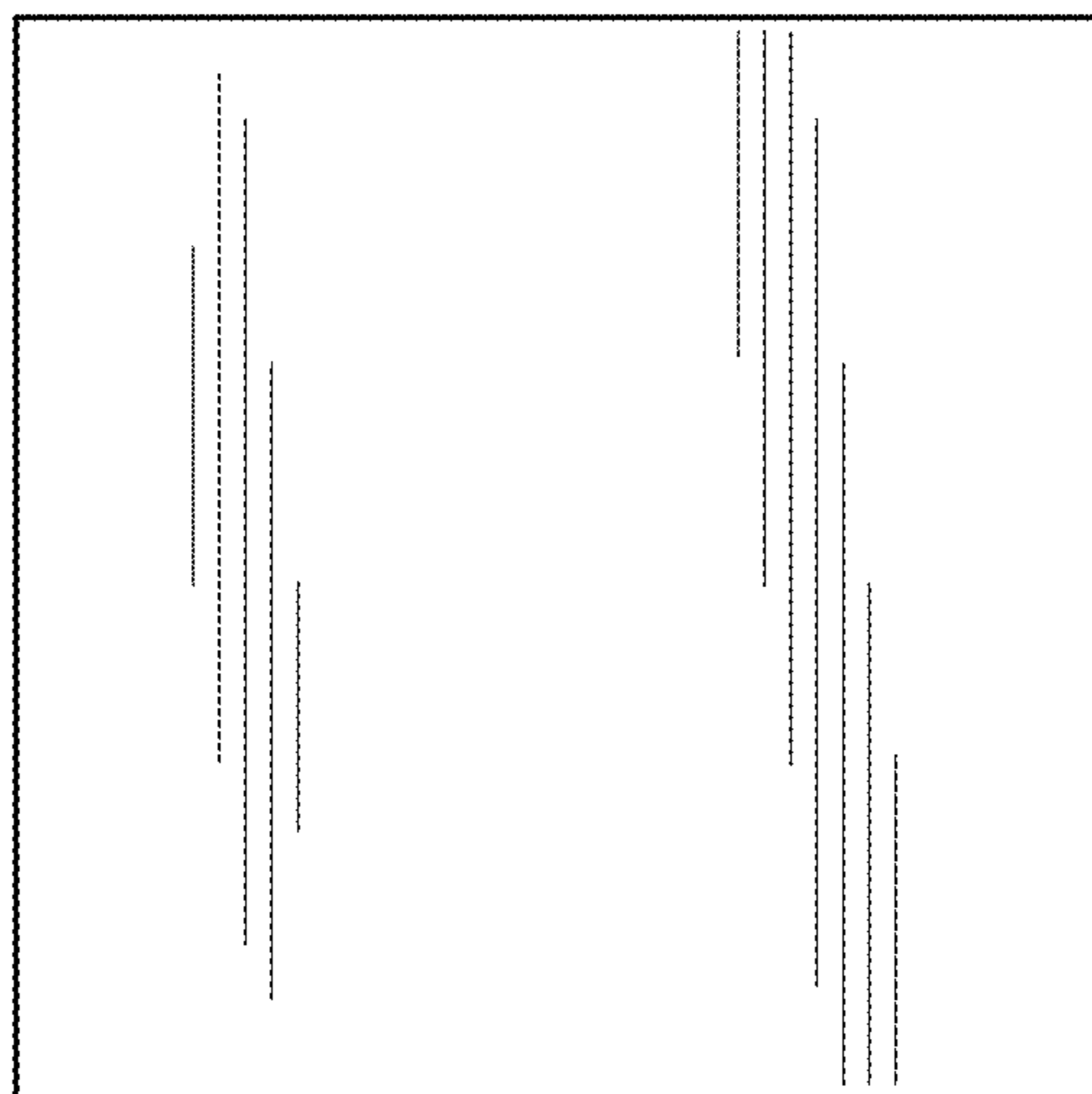

FIG. 6

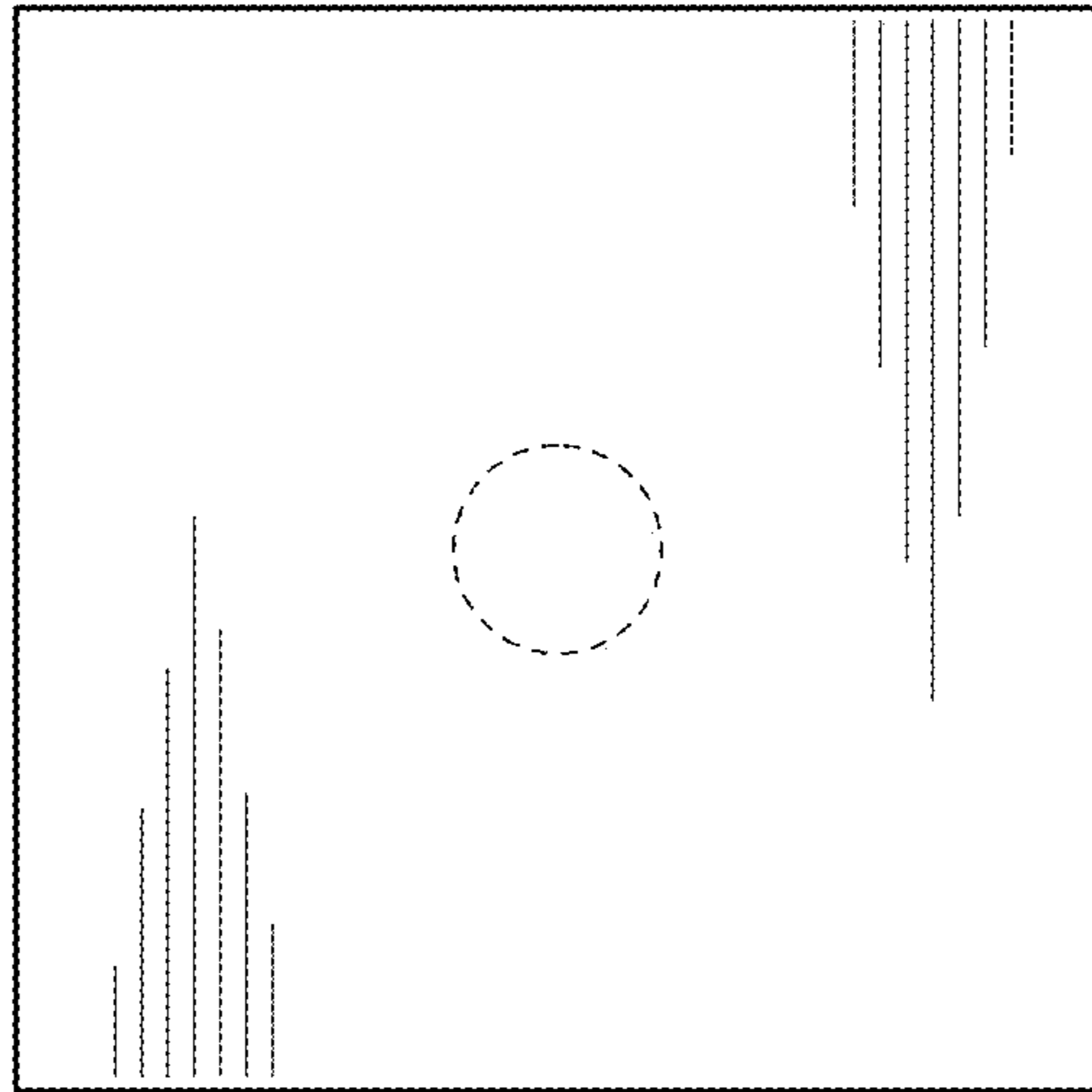

FIG. 7

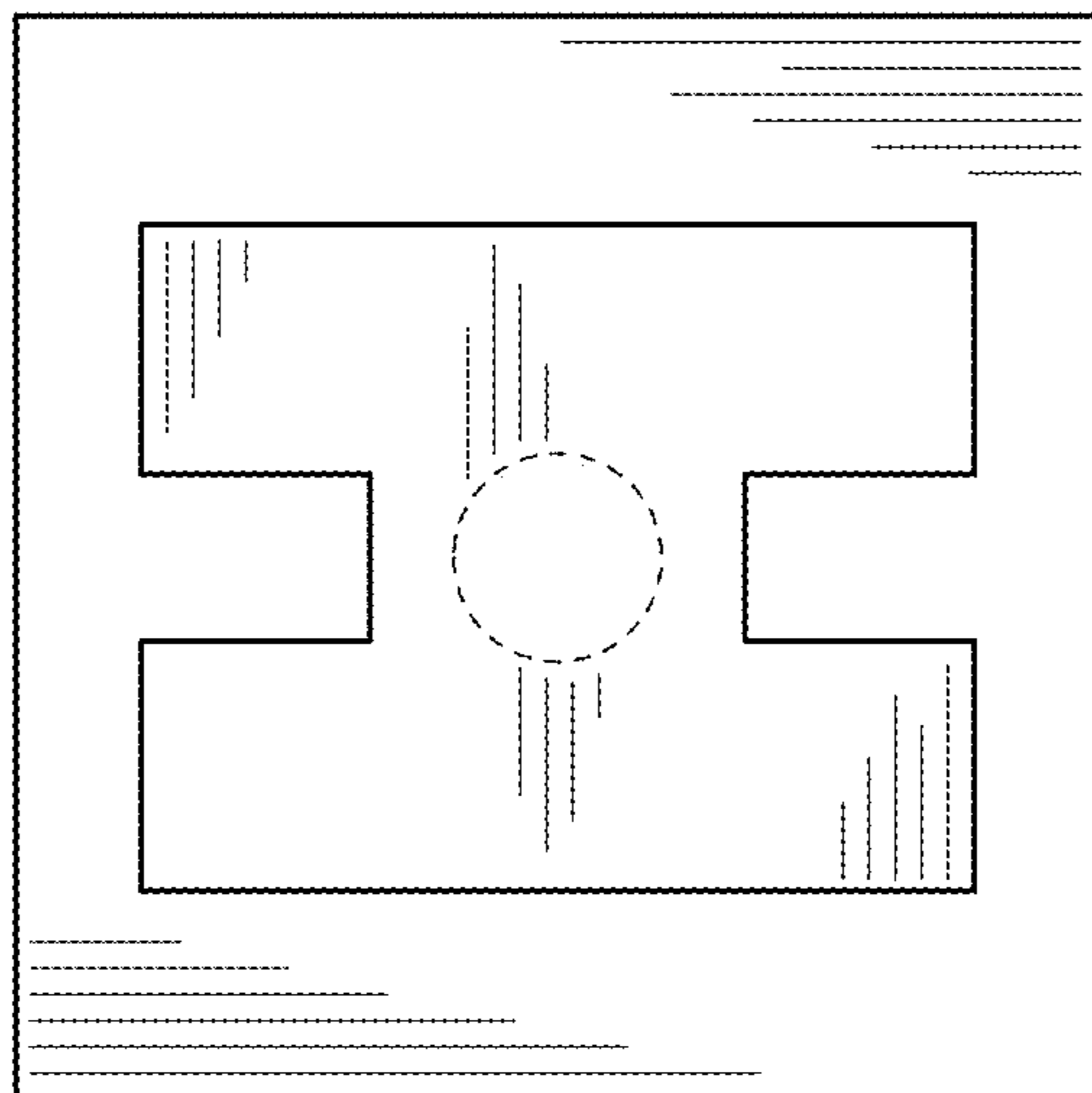

FIG. 8