



US00D870324S

(12) **United States Design Patent**  
**McAlpine et al.**

(10) **Patent No.:** **US D870,324 S**

(45) **Date of Patent:** **\*\* Dec. 17, 2019**

- (54) **COMPACT EMERGENCY LIGHT**
- (71) Applicant: **Thomas & Betts International LLC**,  
Wilmington, DE (US)
- (72) Inventors: **Kelley McAlpine**, Dorval (CA);  
**Francois Couillard**, Laval (CA);  
**Christian Farah**, Dollard-des-Ormeaux  
(CA)
- (73) Assignee: **Thomas & Betts International LLC**,  
Wilmington, DE (US)
- (\*\*) Term: **15 Years**
- (21) Appl. No.: **29/637,789**
- (22) Filed: **Feb. 22, 2018**
- (51) **LOC (12) Cl.** ..... **26-03**
- (52) **U.S. Cl.**  
USPC ..... **D26/24; D10/114.2**
- (58) **Field of Classification Search**  
USPC ..... D26/24, 72, 80, 85, 86  
CPC .. F21S 8/032; F21S 8/033; F21S 8/036; F21S  
9/00; F21S 9/02; F21S 9/022; F21W  
2131/10; F21W 2131/103; F21W  
2131/107; F21W 2131/109  
See application file for complete search history.

D846,174 S \* 4/2019 Yu ..... D26/72  
 2004/0090774 A1 \* 5/2004 Hsueh ..... F21L 4/08  
 362/183  
 2013/0050996 A1 \* 2/2013 Holscher ..... F21S 9/022  
 362/184

\* cited by examiner

*Primary Examiner* — Cathron C Brooks

(74) *Attorney, Agent, or Firm* — Taft Stettinius &  
Hollister LLP; J. Bruce Schelkopf

(57) **CLAIM**

The ornamental design for a compact emergency light, as shown and described.

**DESCRIPTION**

FIG. 1 is a top perspective view of the compact emergency light of the present invention;  
 FIG. 2 is a bottom perspective view of the compact emergency light of the present invention;  
 FIG. 3 is a front plan view of the compact emergency light of the present invention;  
 FIG. 4 is a side plan view of the compact emergency light of the present invention;  
 FIG. 5 is a rear plan view of the compact emergency light of the present invention;  
 FIG. 6 is a side plan view of the compact emergency light of the present invention;  
 FIG. 7 is a top plan view of the compact emergency light of the present invention; and,  
 FIG. 8 is a bottom plan view of the compact emergency light of the present invention.  
 The broken line portion of the Figures is included to show unclaimed subject matter and forms no part of the claimed design.

**1 Claim, 7 Drawing Sheets**

(56) **References Cited**

**U.S. PATENT DOCUMENTS**

- 6,193,395 B1 \* 2/2001 Logan ..... F21S 9/022  
362/269
- D552,292 S \* 10/2007 Martineau ..... D10/111
- D578,242 S \* 10/2008 Couillard ..... D26/85
- 7,824,067 B2 \* 11/2010 Martineau ..... F21S 9/022  
362/247
- D670,592 S \* 11/2012 Ten Wolde ..... D10/114.2
- D841,859 S \* 2/2019 Yu ..... D26/72

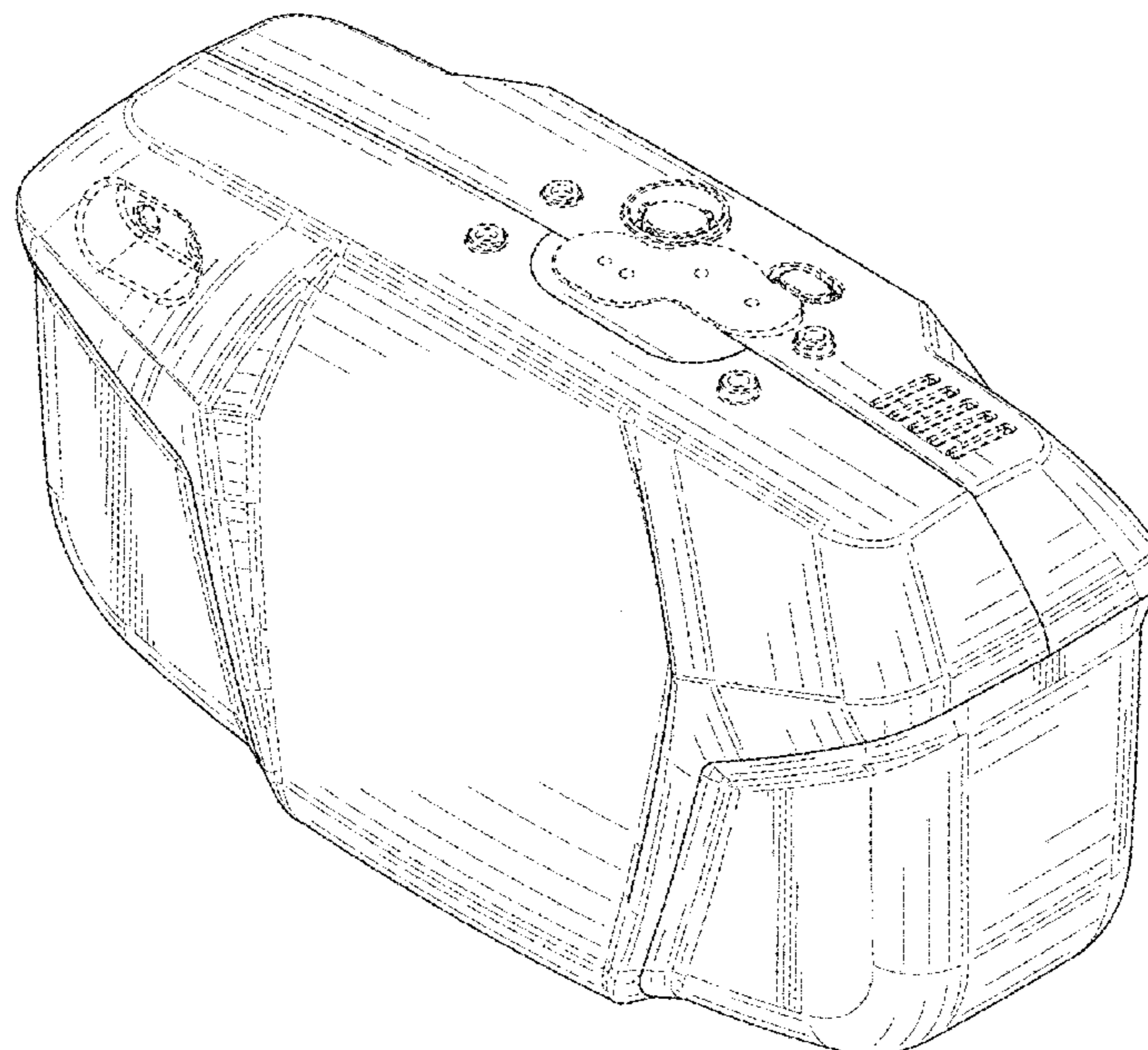

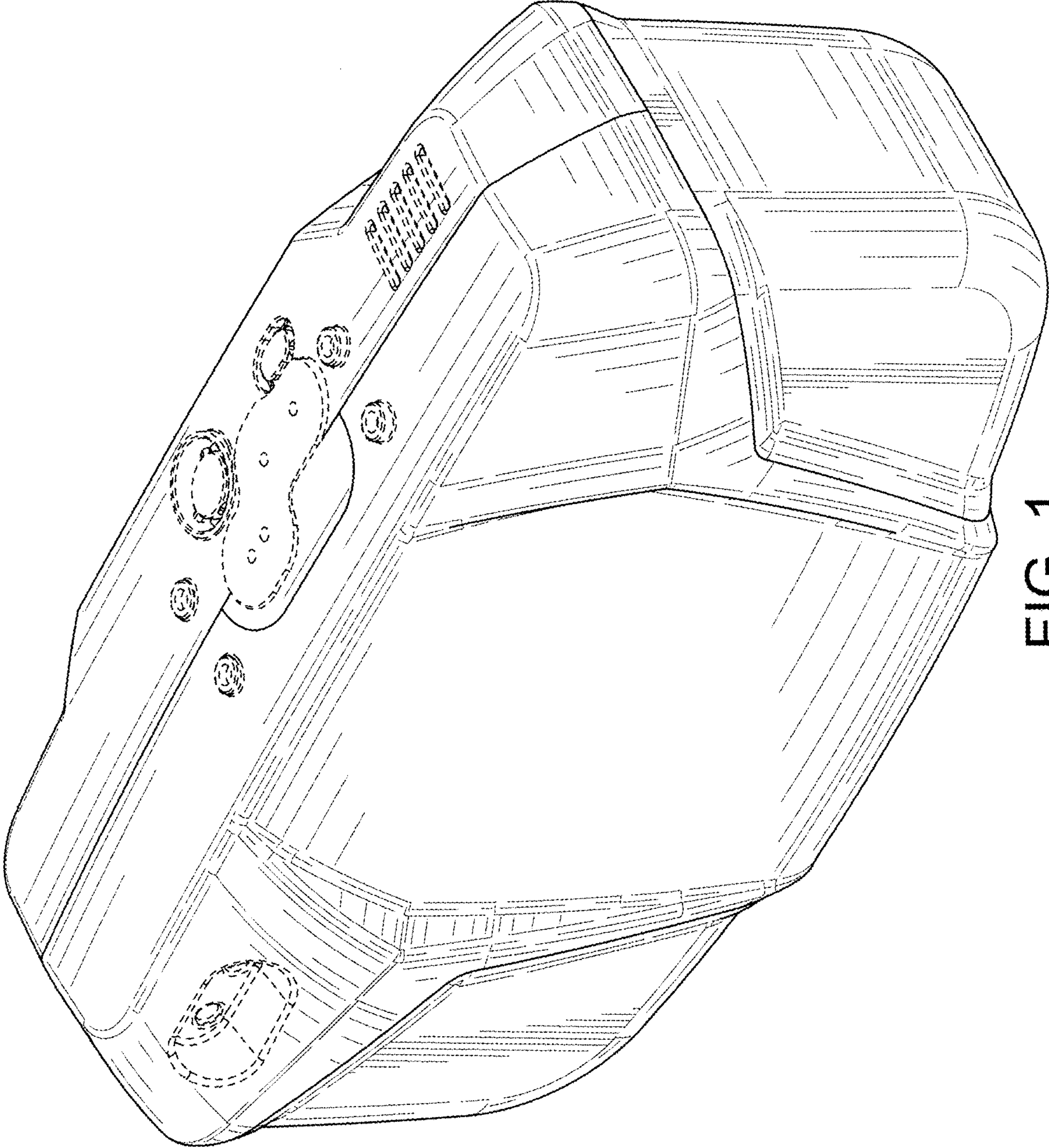

FIG. 1

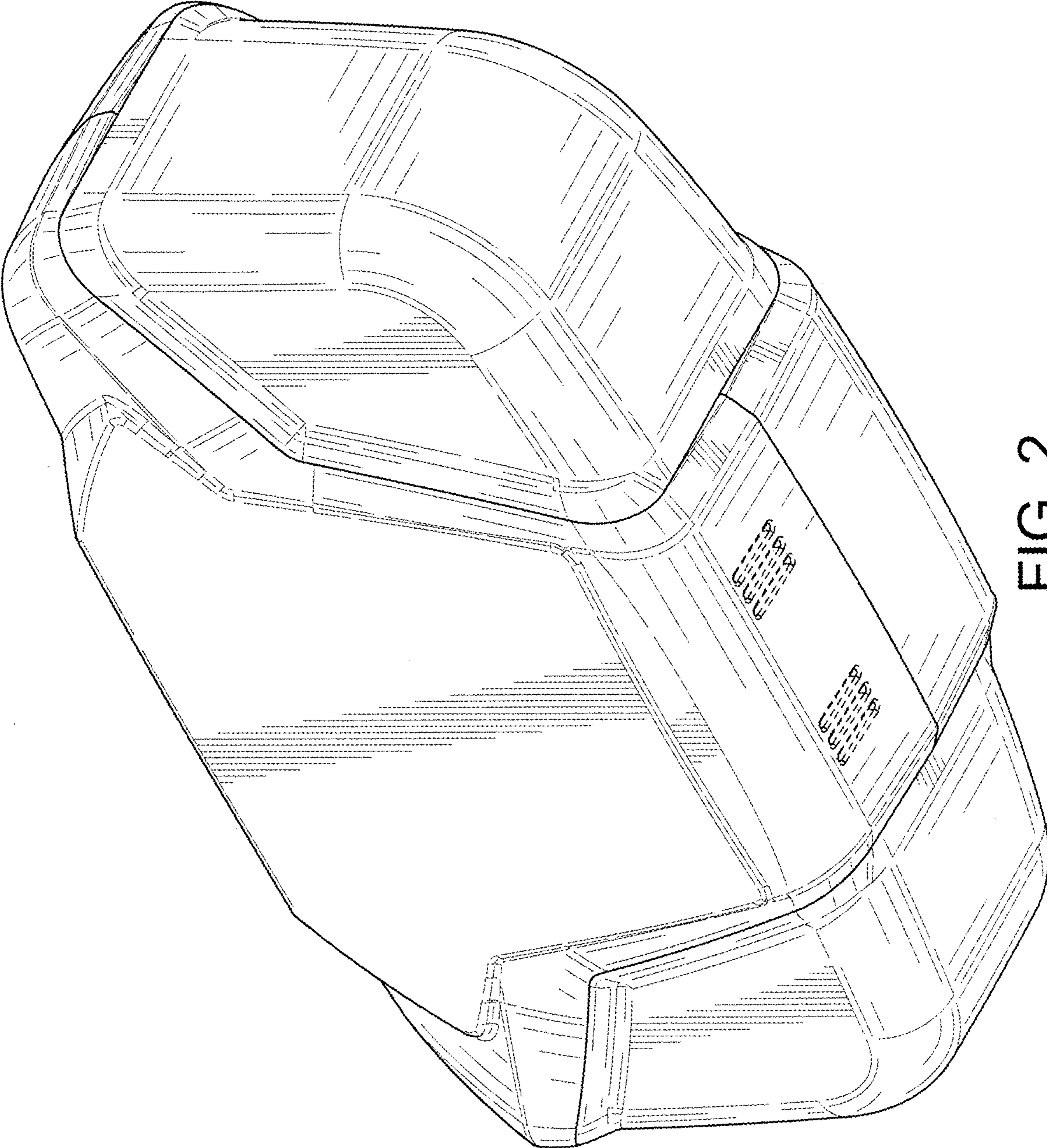

FIG. 2

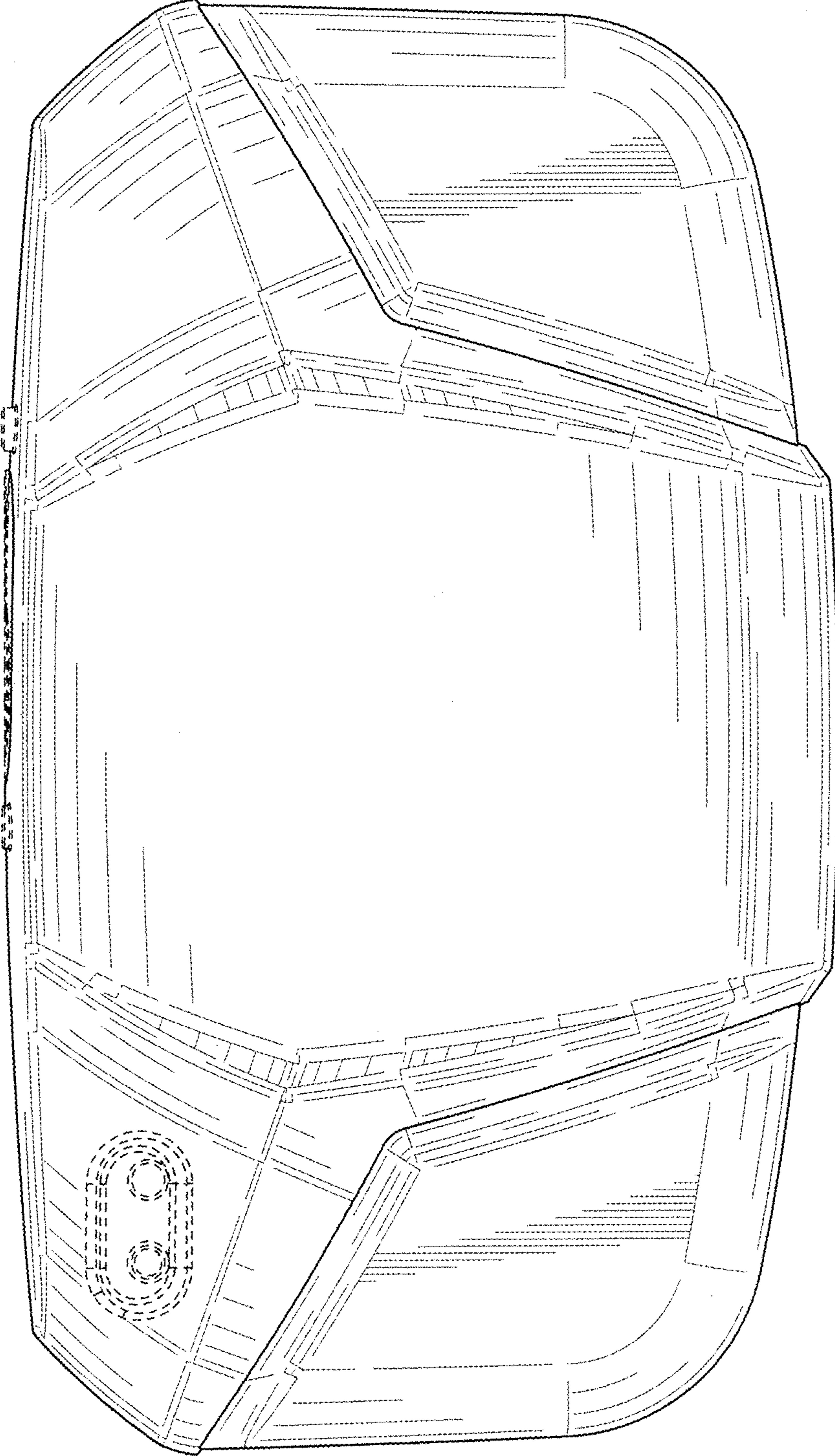

FIG. 3

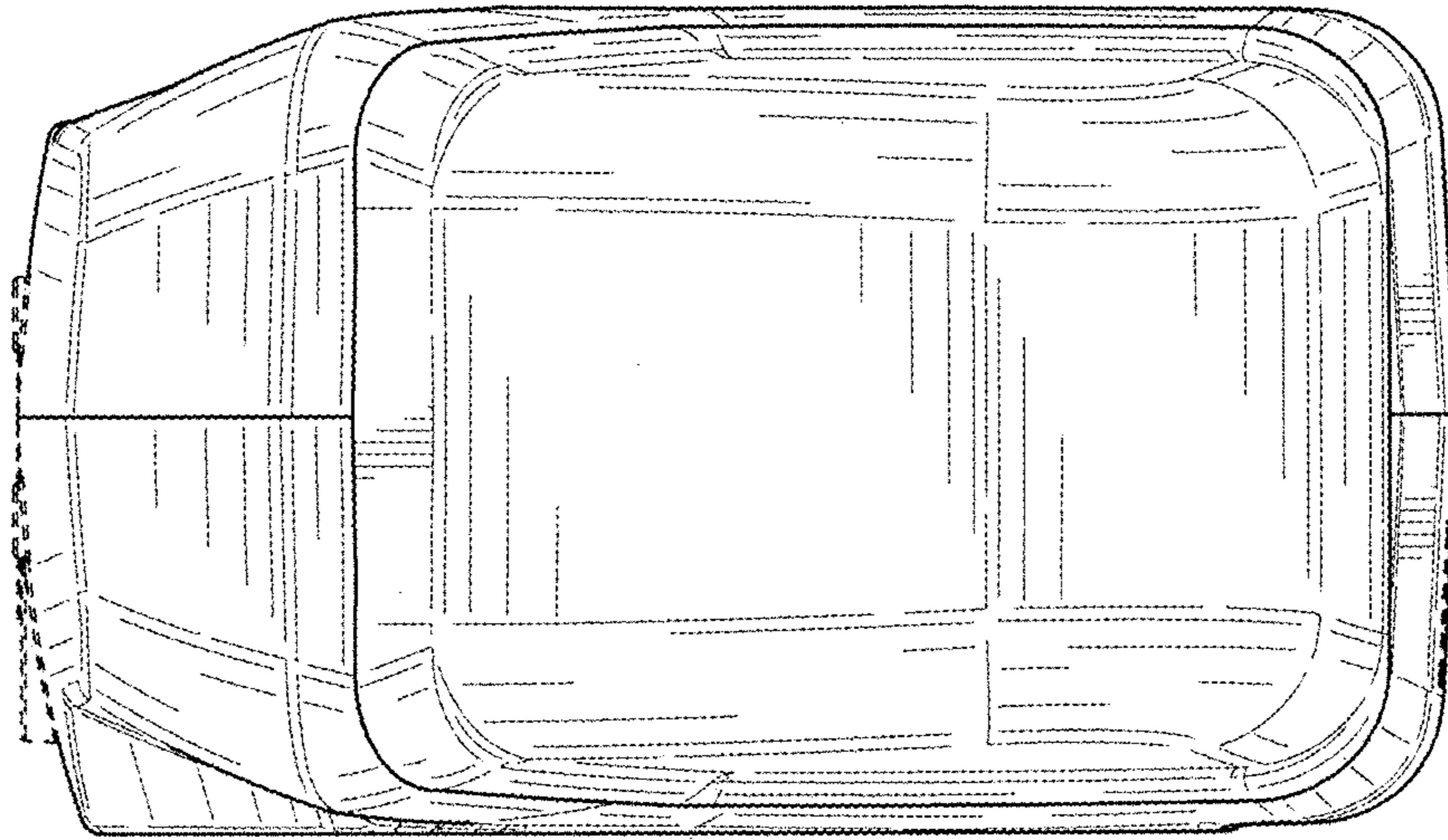

FIG. 4

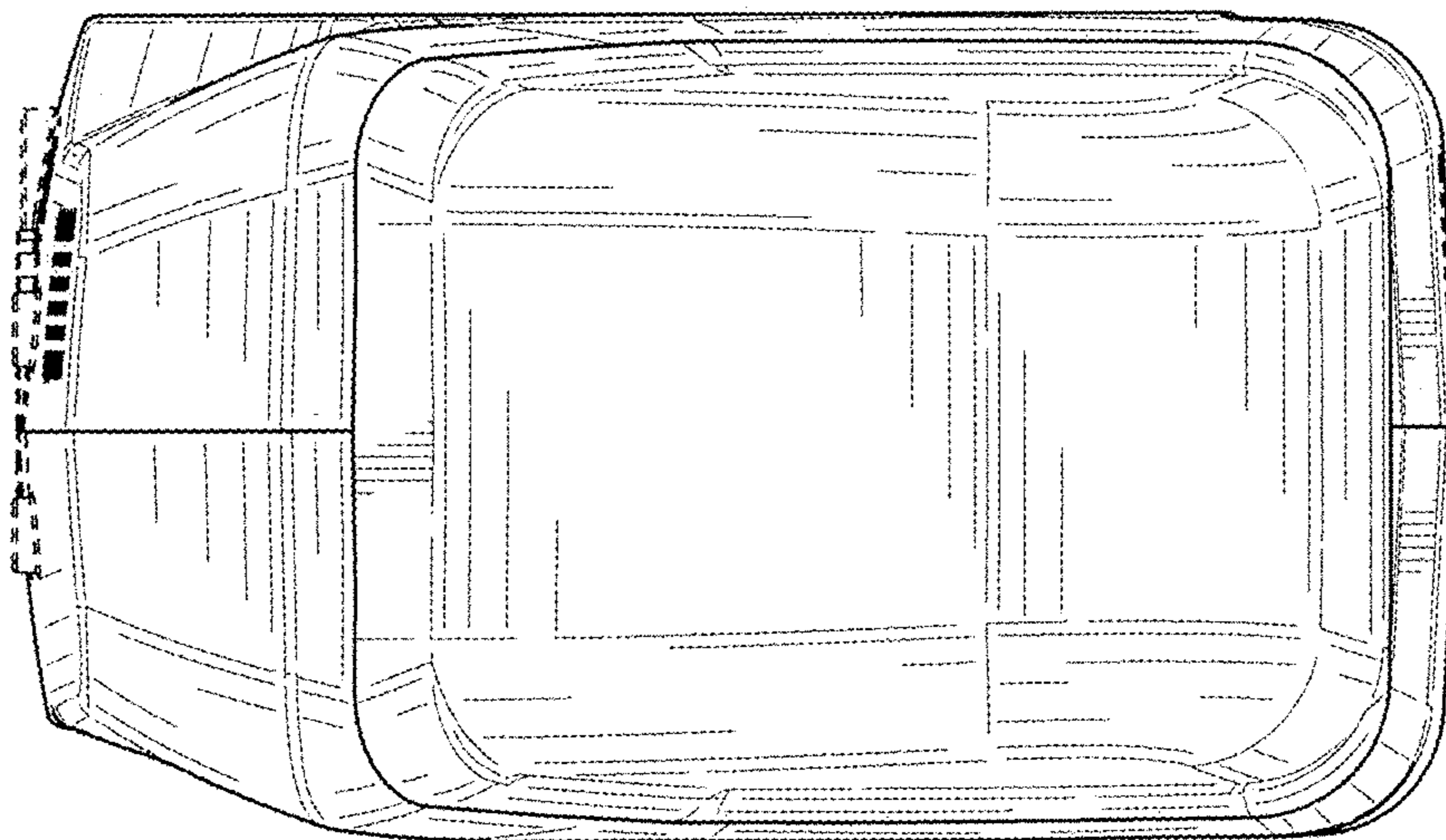

FIG. 6

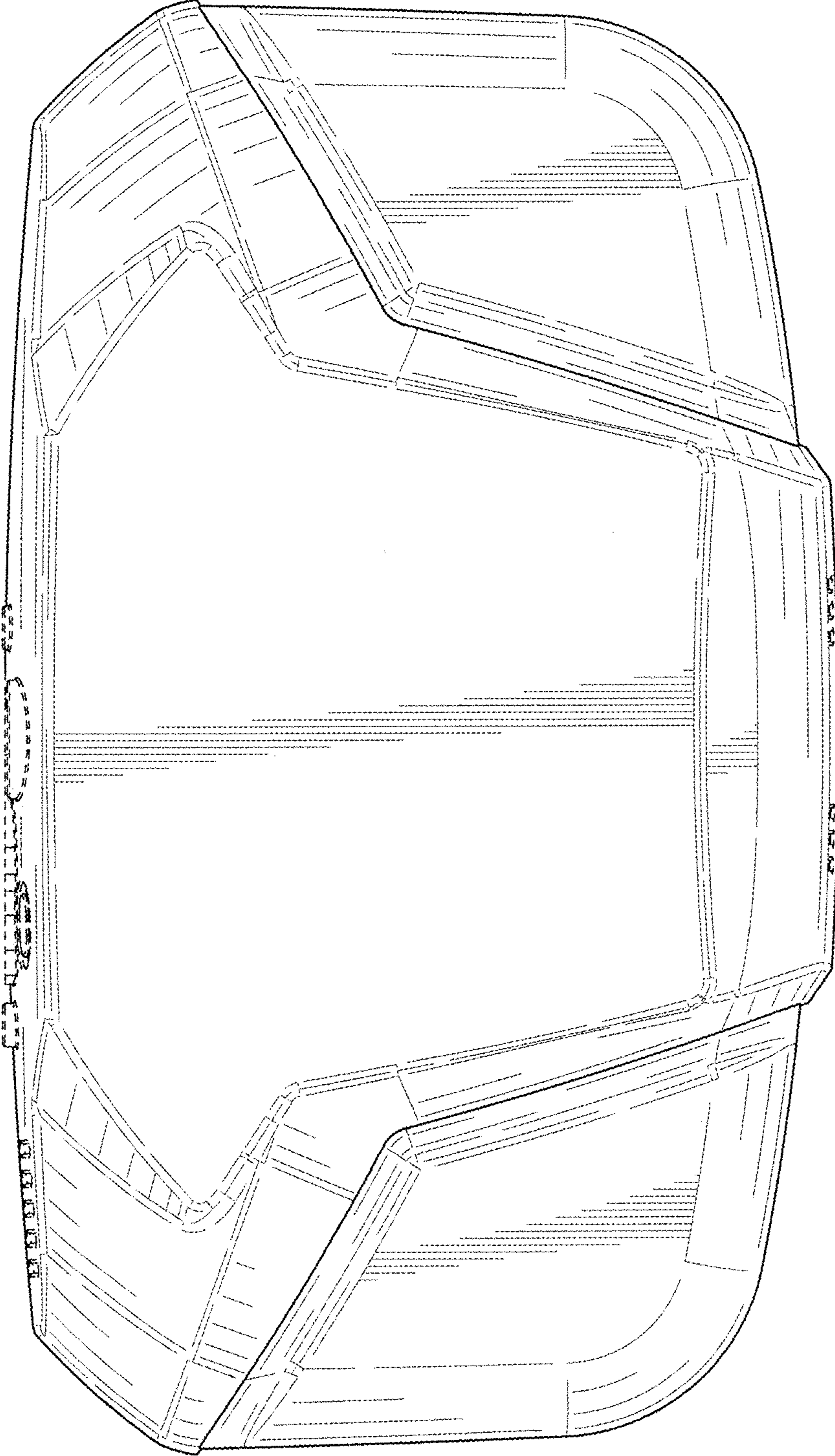

FIG. 5

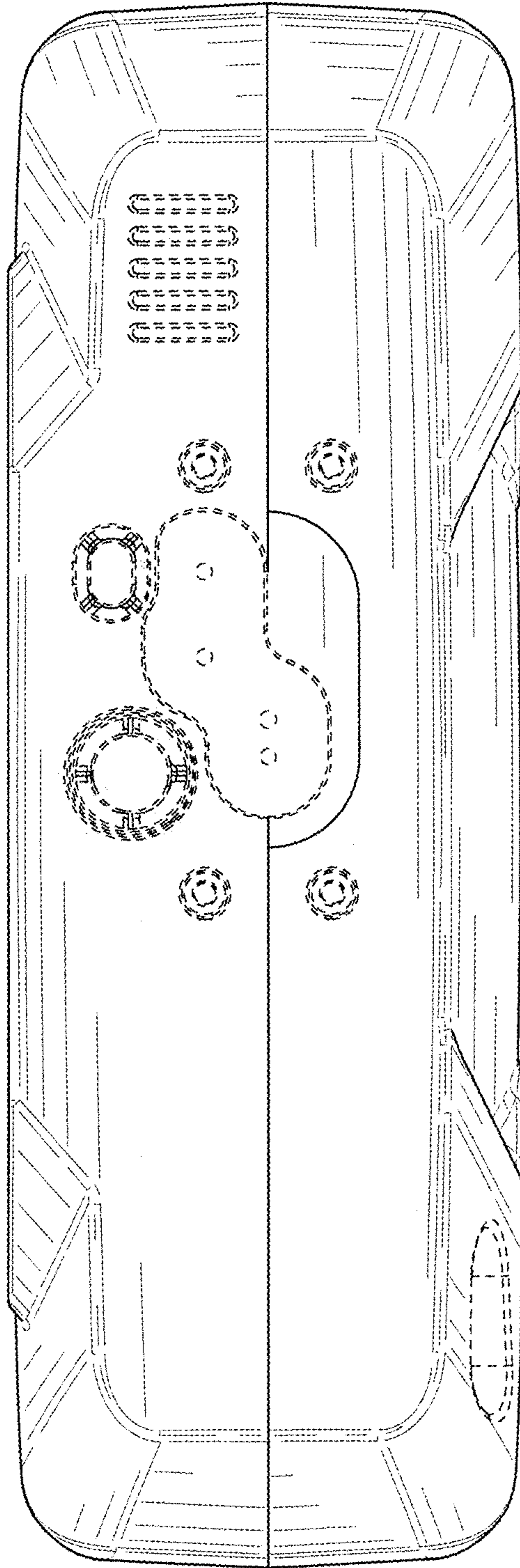

FIG. 7

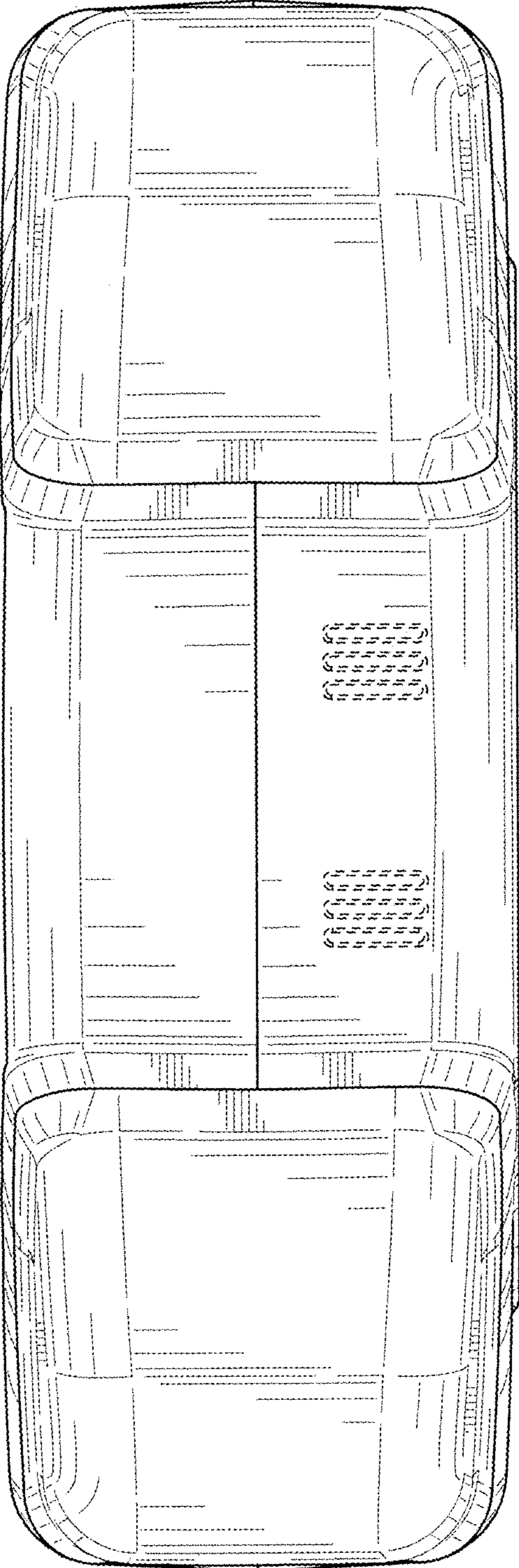

FIG. 8