



US00D870292S

(12) **United States Design Patent** (10) **Patent No.:** **US D870,292 S**  
**Cramer et al.** (45) **Date of Patent:** **\*\* Dec. 17, 2019**

(54) **HEARING AID**

(71) Applicant: **SIVANTOS PTE. LTD**, Singapore (SG)

(72) Inventors: **Harald Cramer**, Esslingen (DE); **Vincent Hasenmayer**, Stuttgart (DE); **Lit Song Ding**, Singapore (SG); **Vinay Joshi**, Singapore (SG); **Anand Ganapathy**, Singapore (SG); **Zainal Abidin Mohd Yahya**, Singapore (SG)

(73) Assignee: **Sivantos Pte. Ltd.**, Singapore (SG)

(\*\*) Term: **15 Years**

(21) Appl. No.: **35/504,725**

(22) Filed: **Feb. 27, 2018**

(80) **Hague Agreement Data**

Int. Filing Date: **Feb. 27, 2018**

Int. Reg. No.: **DM/100304**

Int. Reg. Date: **Feb. 27, 2018**

Int. Reg. Pub. Date: **Apr. 6, 2018**

(30) **Foreign Application Priority Data**

Aug. 31, 2017 (EM) ..... 004173896-0001

Aug. 31, 2017 (EM) ..... 004173896-0002

Aug. 31, 2017 (EM) ..... 004173896-0003

(51) **LOC (12) Cl.** ..... **24-99**

(52) **U.S. Cl.**  
USPC ..... **D24/174**

(58) **Field of Classification Search**  
USPC ..... D14/223, 239, 203.1, 238.1, 126, 132,  
D14/204, 205, 215, 216, 217; D24/174

(Continued)

(56) **References Cited**

U.S. PATENT DOCUMENTS

D667,122 S \* 9/2012 Mori ..... D24/174  
D722,168 S \* 2/2015 Darkes ..... D24/174

(Continued)

*Primary Examiner* — Eliza Z Bennett-Hattan

(74) *Attorney, Agent, or Firm* — Laurence A. Greenberg;  
Werner H. Stemer; Ralph E. Locher

(57) **CLAIM**

The ornamental design for a hearing aid, as shown and described.

**DESCRIPTION**

- 1. Hearing aid
- 2.-3. Parts of hearing aids
- 1.1 : Front
- 1.2 : Right
- 1.3 : Left
- 1.4 : Top
- 1.5 : Bottom
- 1.6 : Perspective
- 1.7 : Perspective
- 1.8 : Back
- 2.1 : Front
- 2.2 : Right
- 2.3 : Left
- 2.4 : Top
- 2.5 : Bottom
- 2.6 : Perspective
- 2.7 : Perspective
- 2.8 : Back
- 3.1 : Front
- 3.2 : Right
- 3.3 : Left
- 3.4 : Top

(Continued)

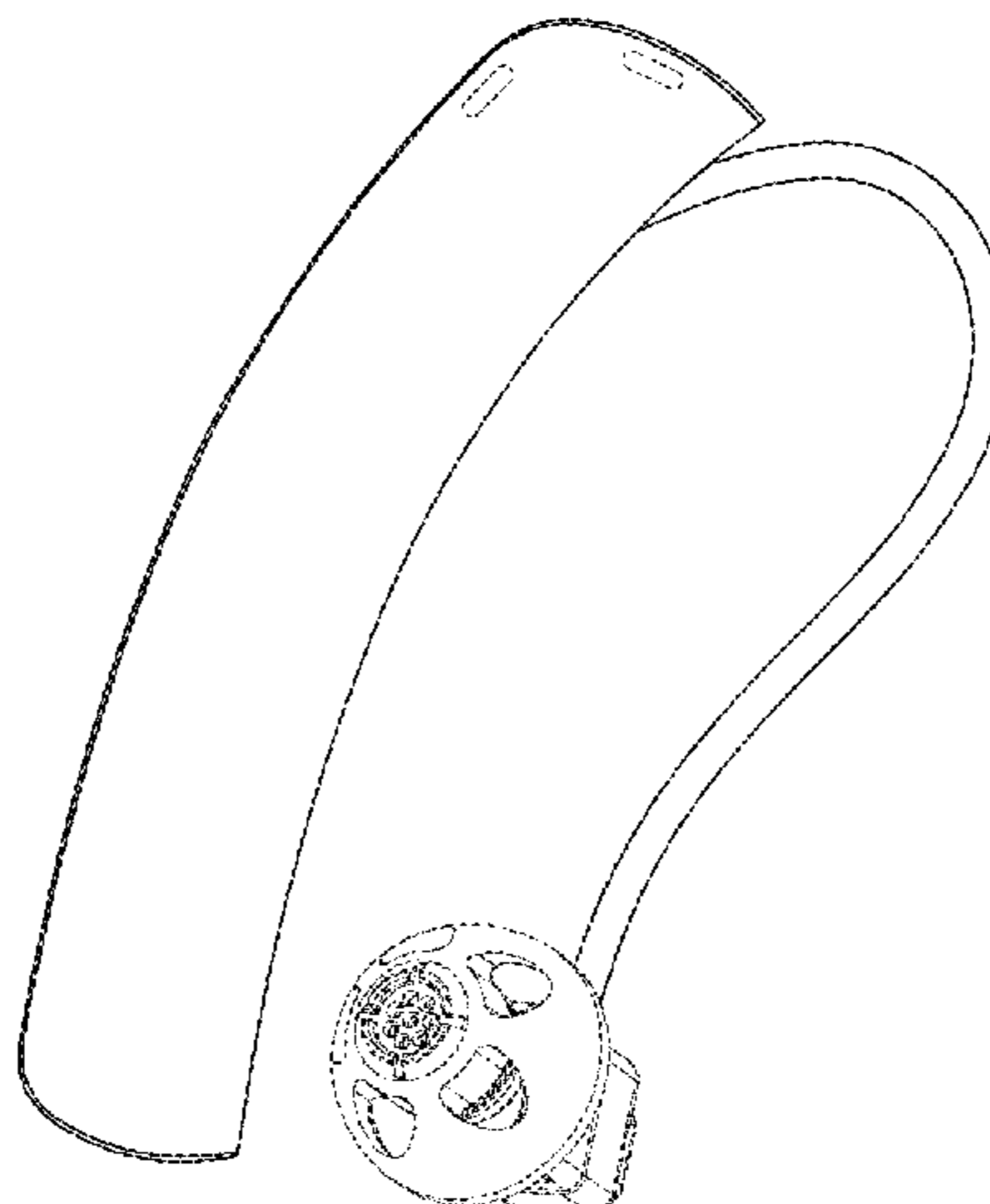

3.5 : Bottom

3.6 : Perspective

3.7 : Perspective

3.8 : Back

The broken lines in the drawing depict unclaimed portions of the hearing aid only and form no part of the claimed design.

**1 Claim, 24 Drawing Sheets**

(58) **Field of Classification Search**

CPC .. H04R 2225/55; H04R 25/70; H04R 25/552;  
H04R 2225/43; H04R 25/558; H04R  
25/65; H04R 2225/025

See application file for complete search history.

(56) **References Cited**

U.S. PATENT DOCUMENTS

D772,417 S	*	11/2016	Li .....	D24/174
D773,671 S	*	12/2016	Johner .....	D24/174
D804,034 S	*	11/2017	Gabathuler .....	D24/174
D804,035 S	*	11/2017	Gabathuler .....	D24/174
D806,251 S	*	12/2017	Lockenwitz .....	D24/174
D806,252 S	*	12/2017	Lockenwitz .....	D24/174
D806,253 S	*	12/2017	Lockenwitz .....	D24/174

\* cited by examiner

1.1

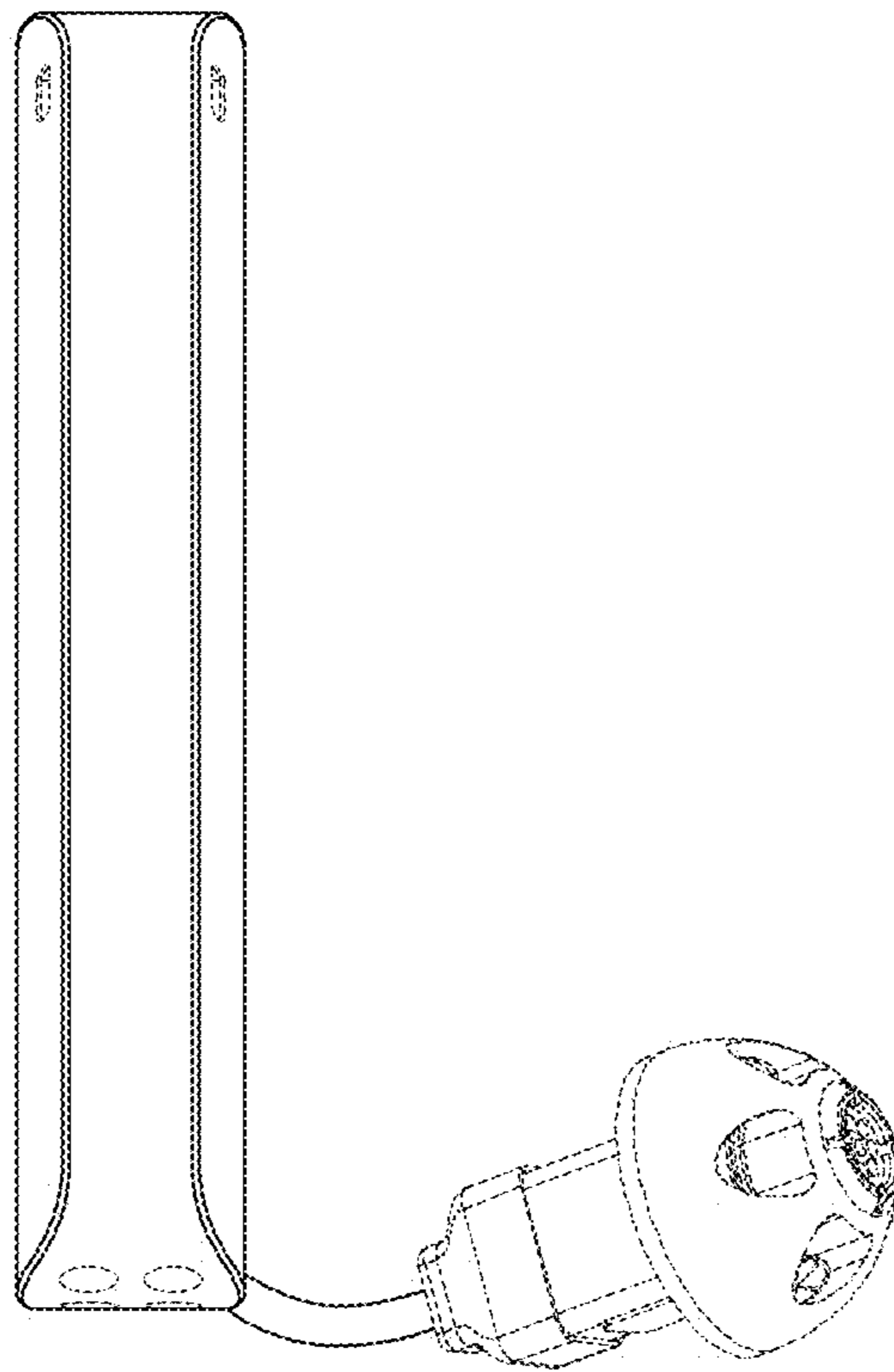

1.2

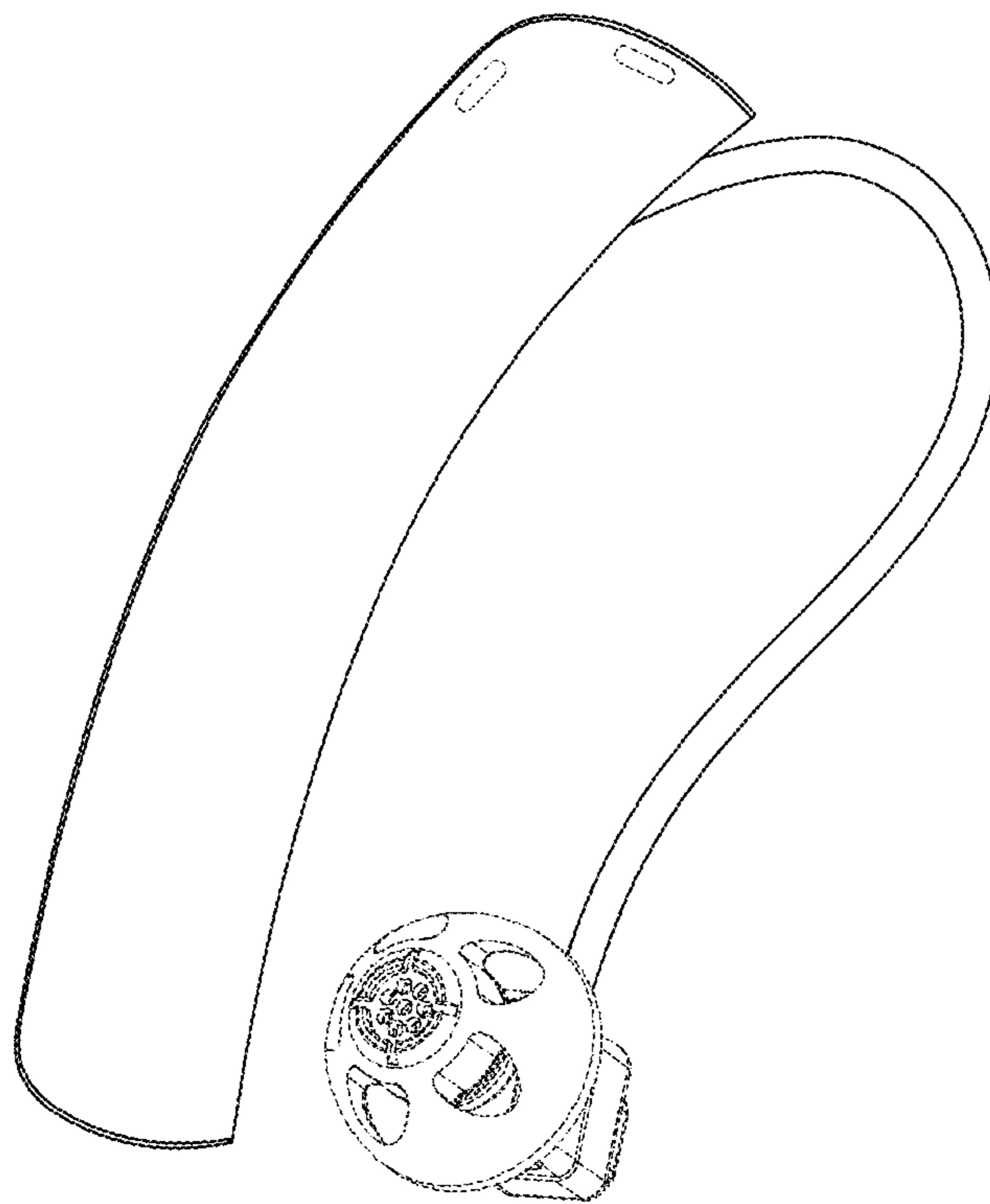

1.3

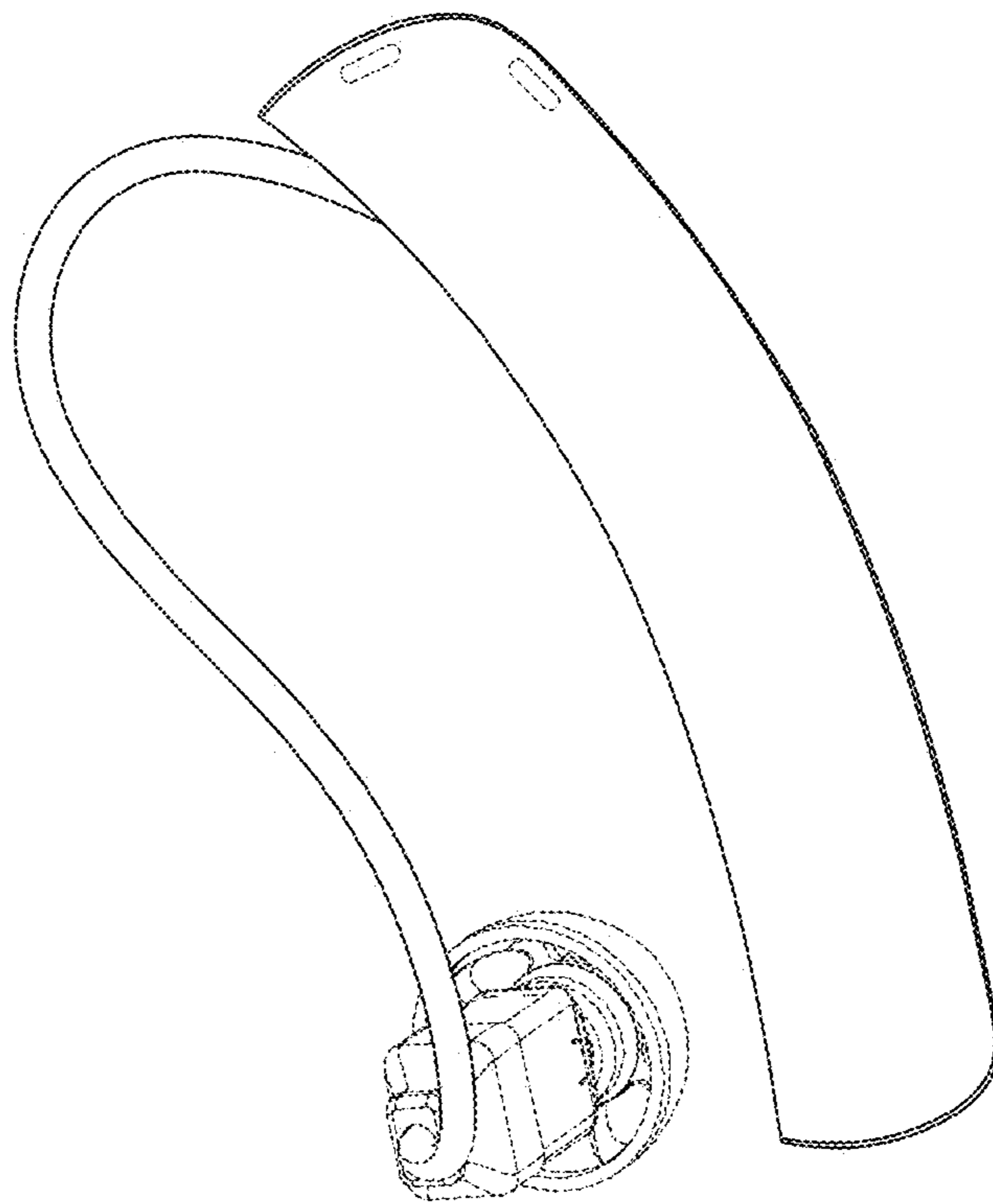

1.4

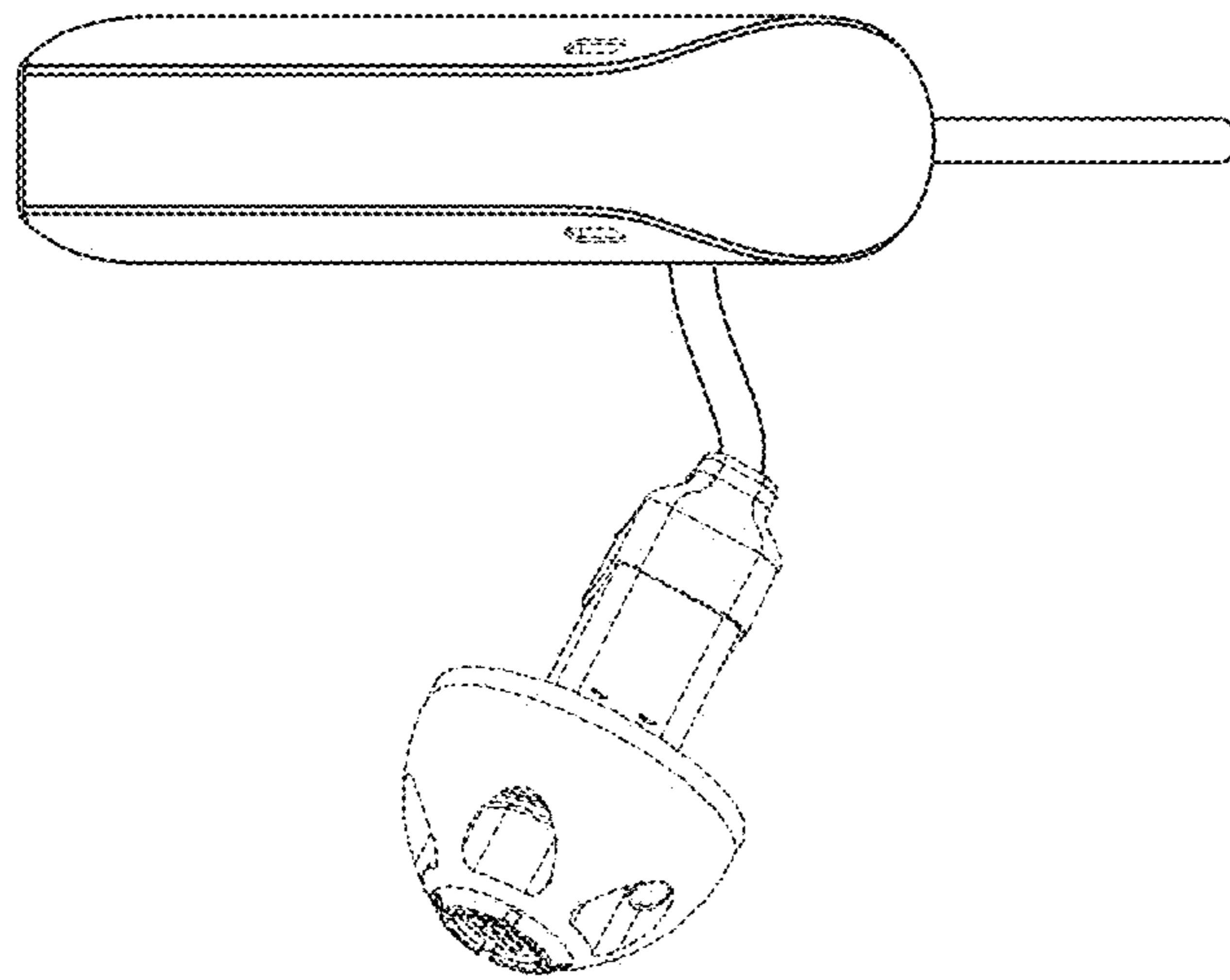

1.5

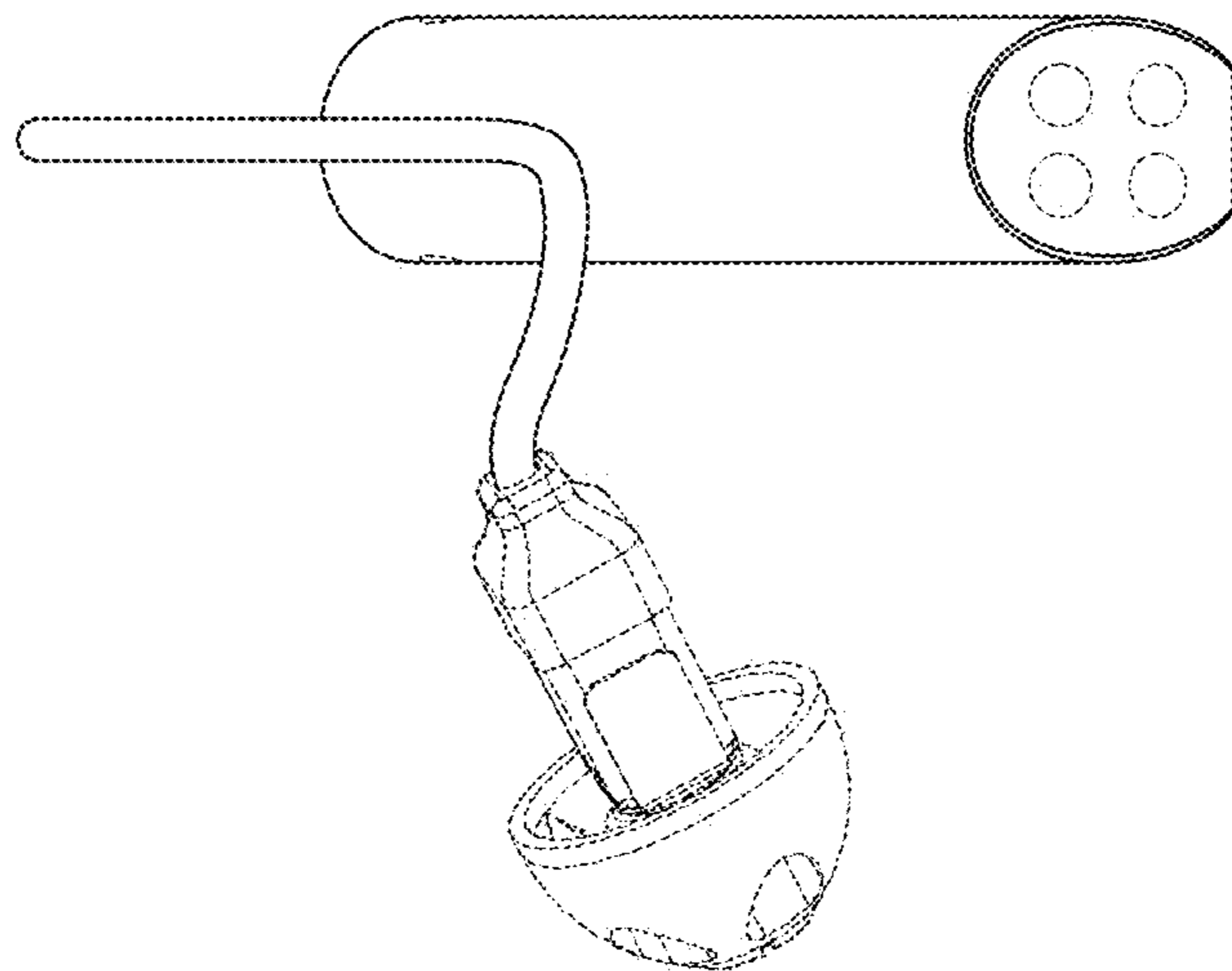

1.6

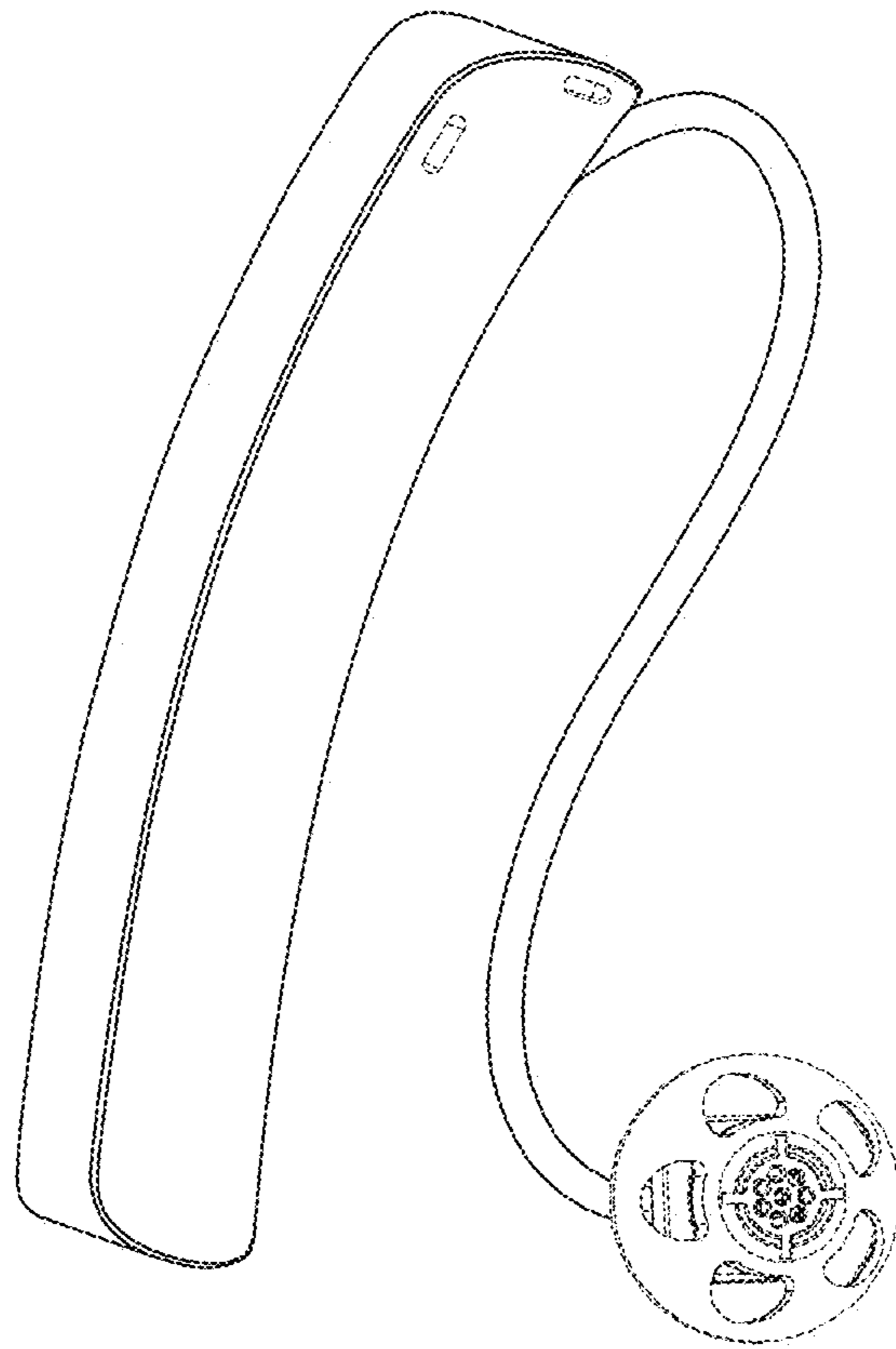



1.7

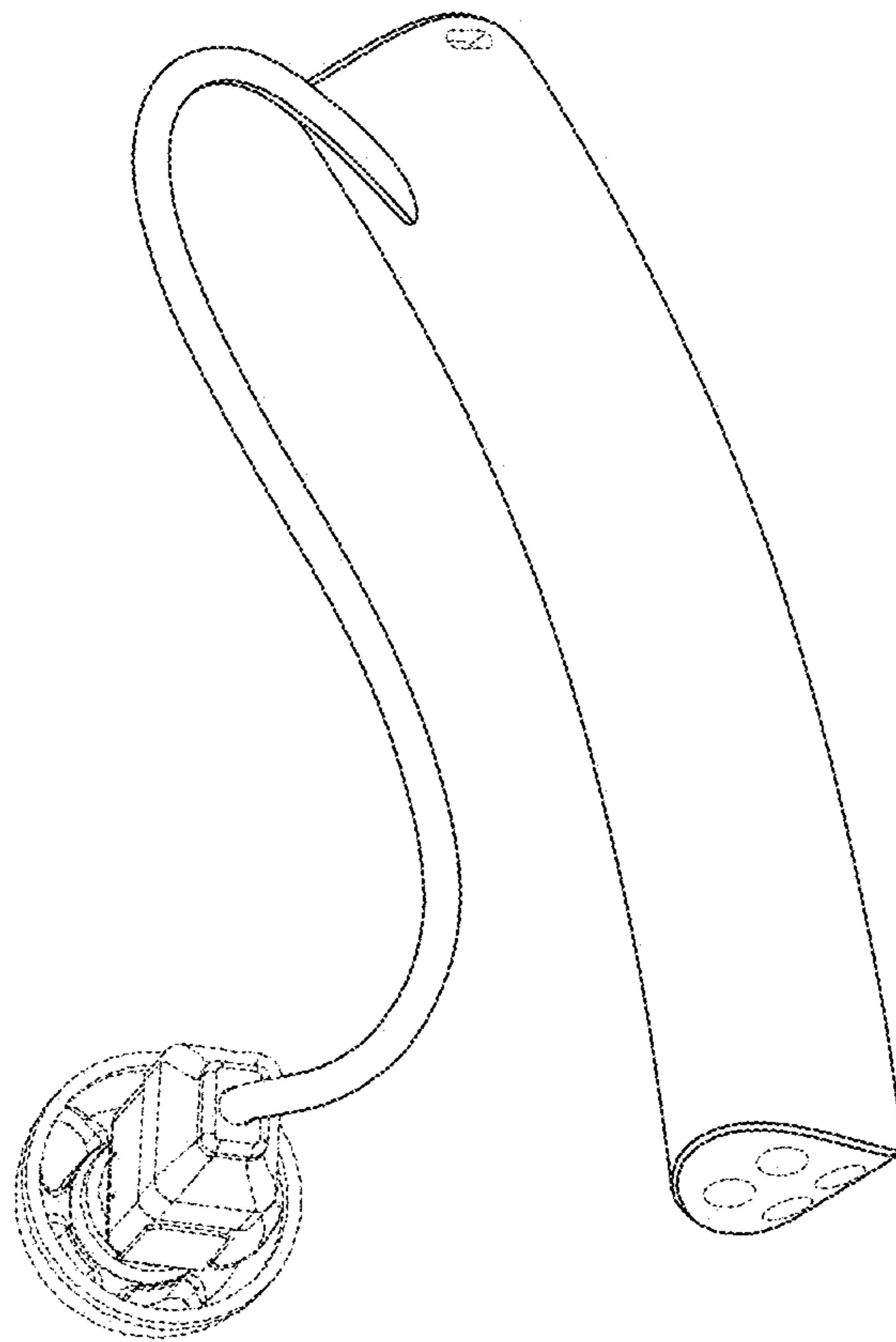

1.8

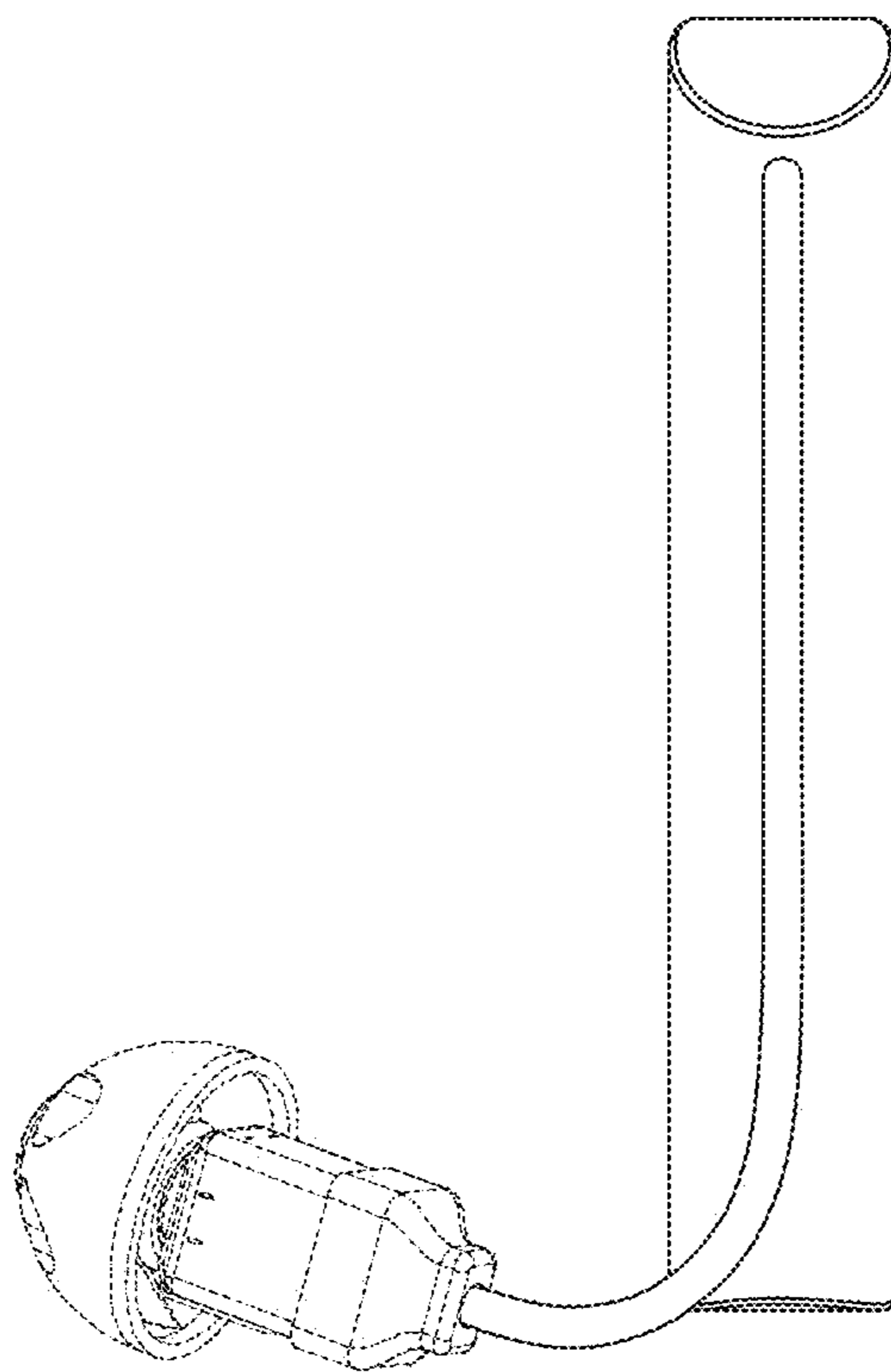

2.1

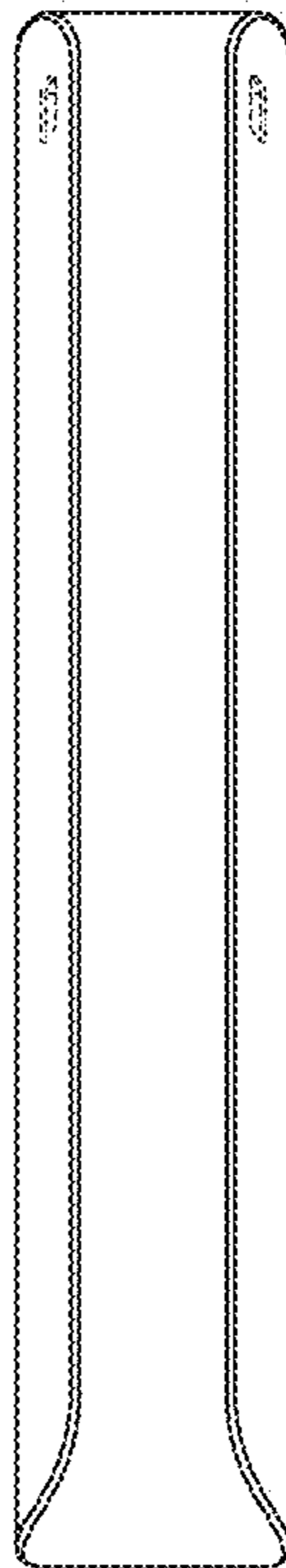

2.2

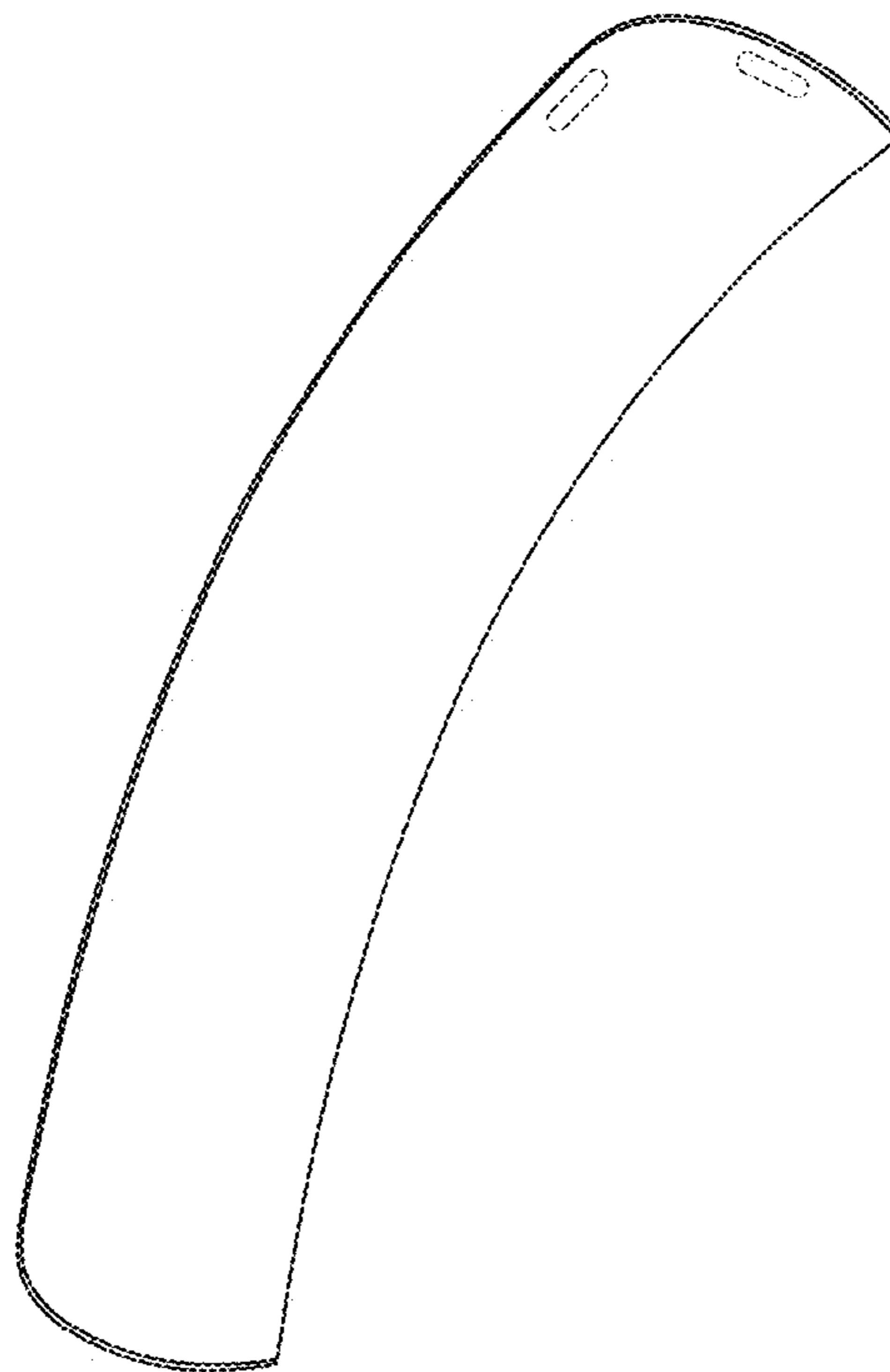

2.3

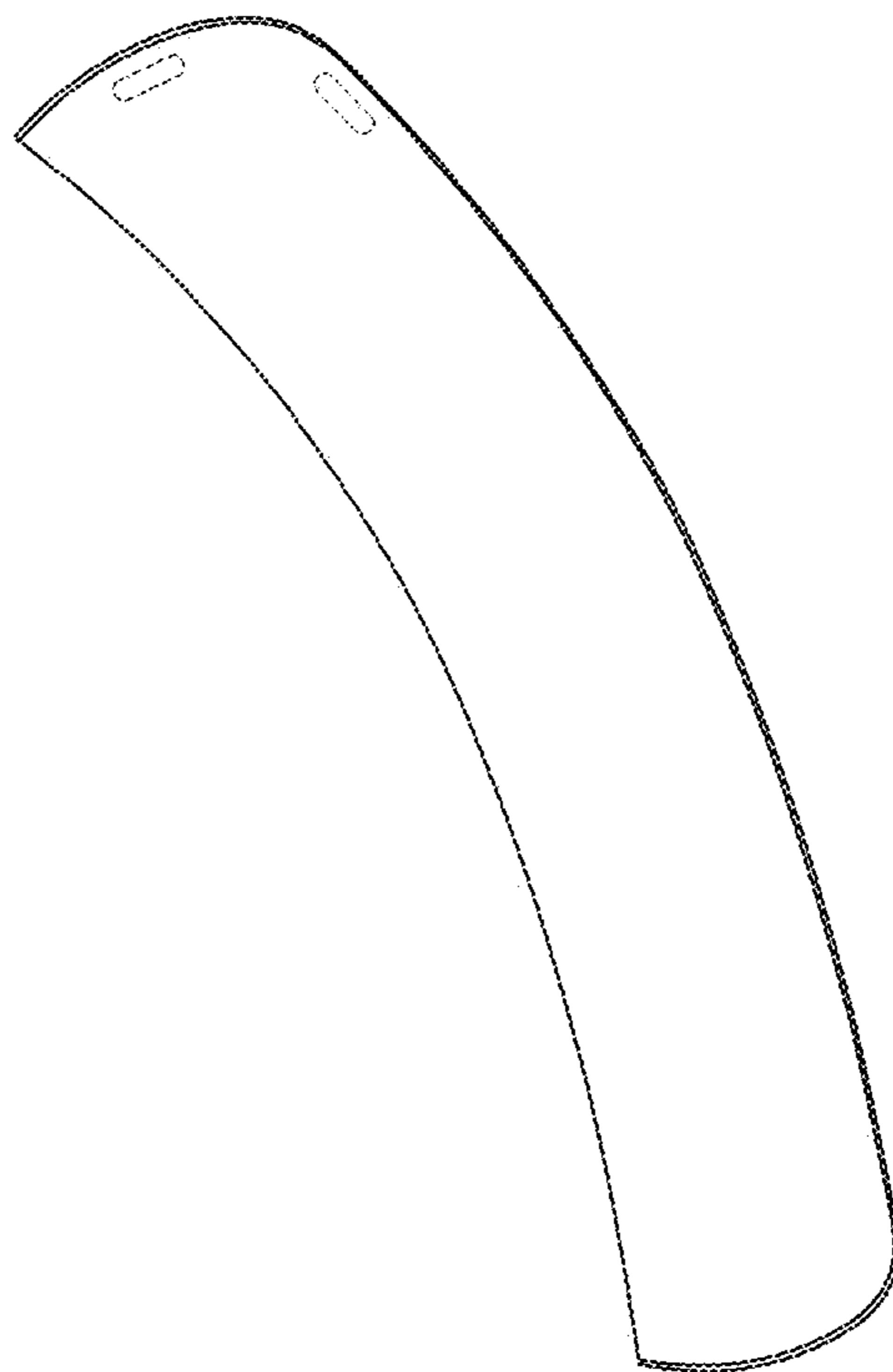

2.4

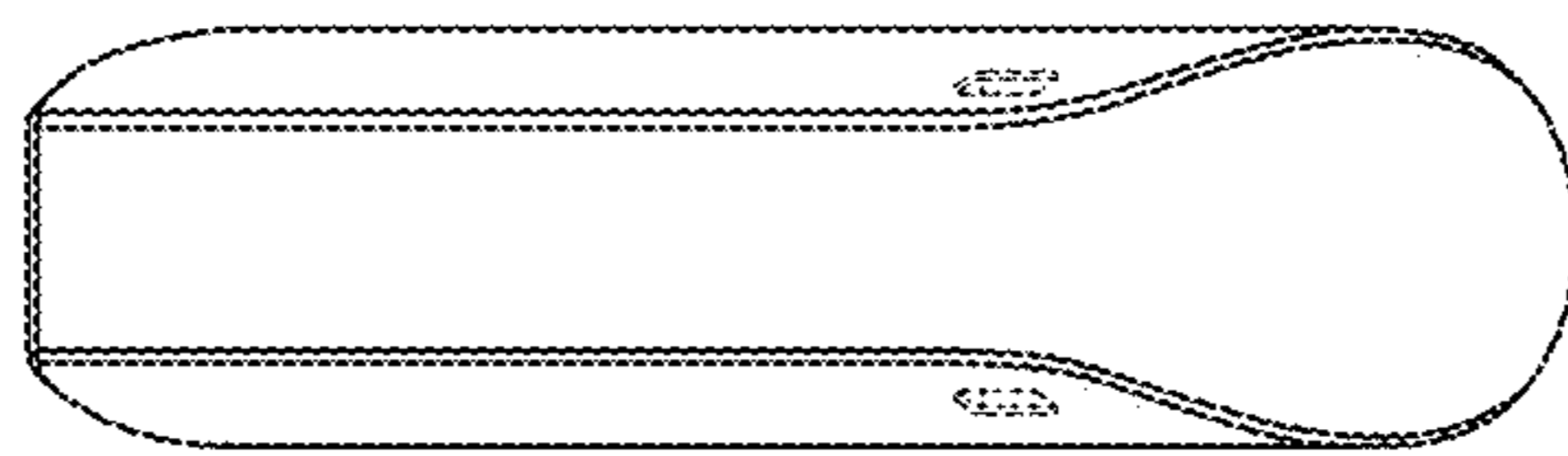

2.5

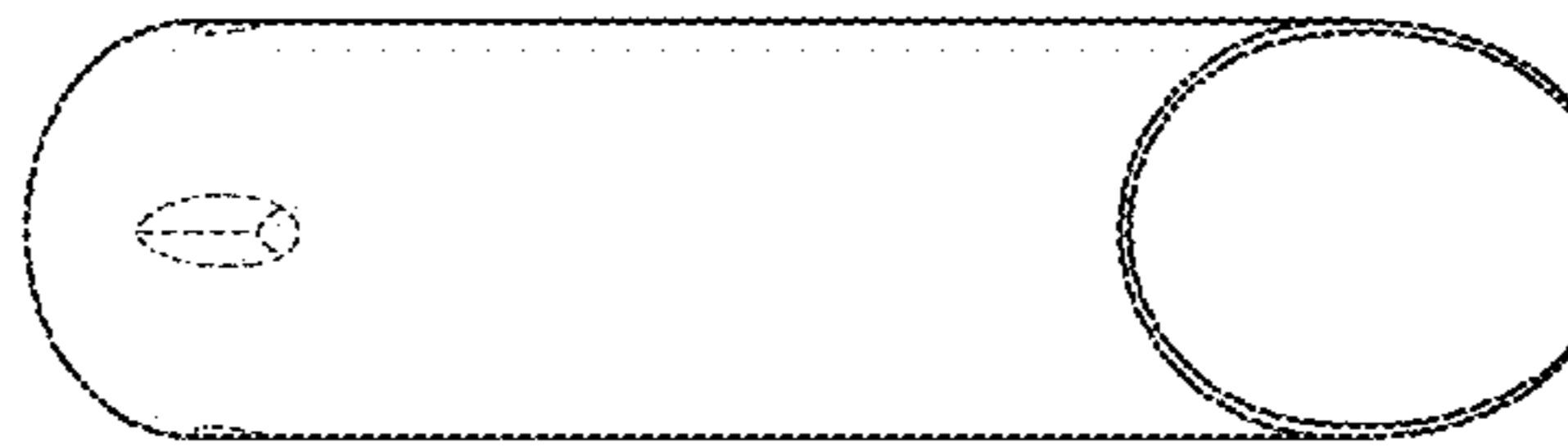

2.6

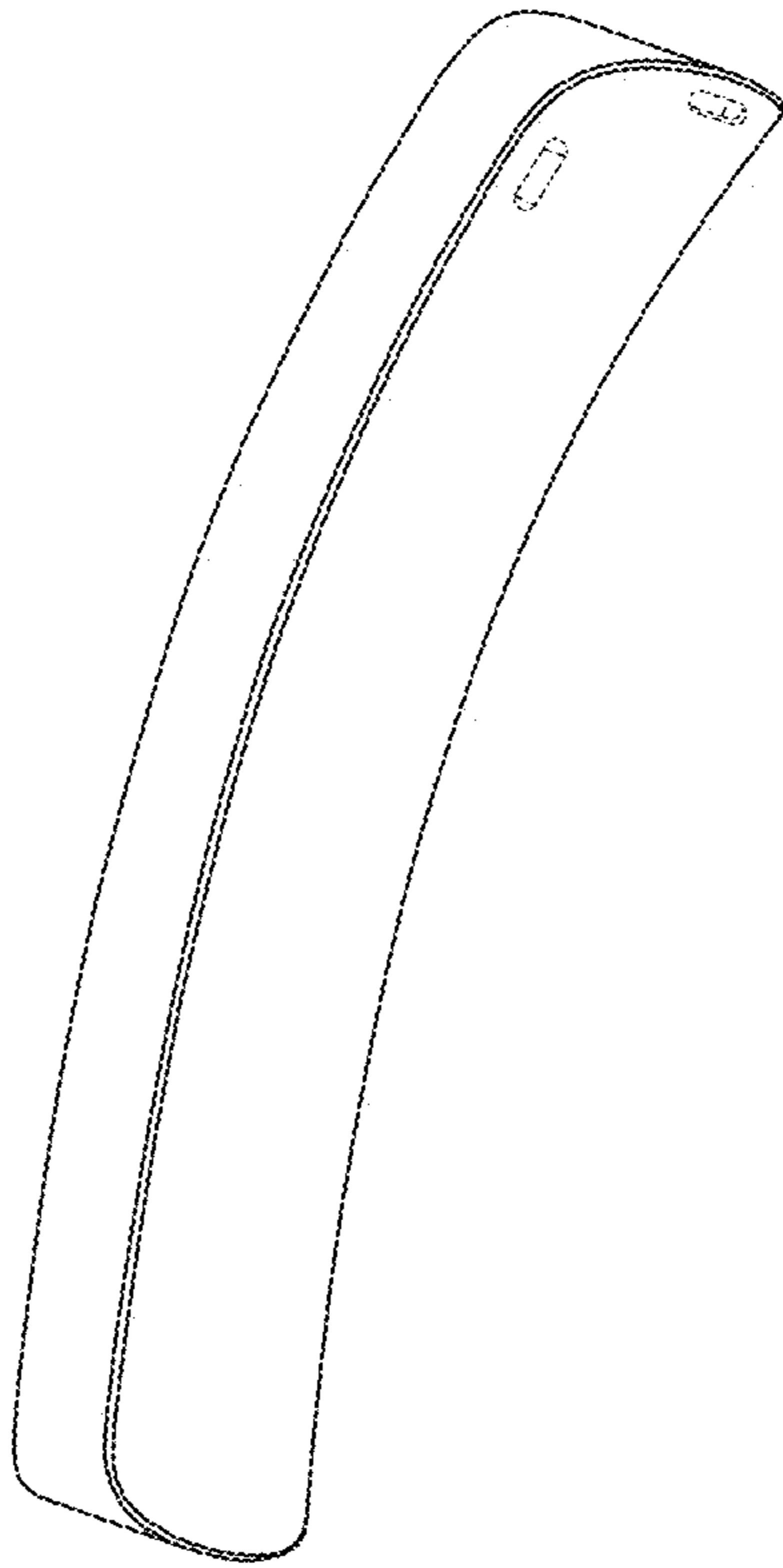



2.7

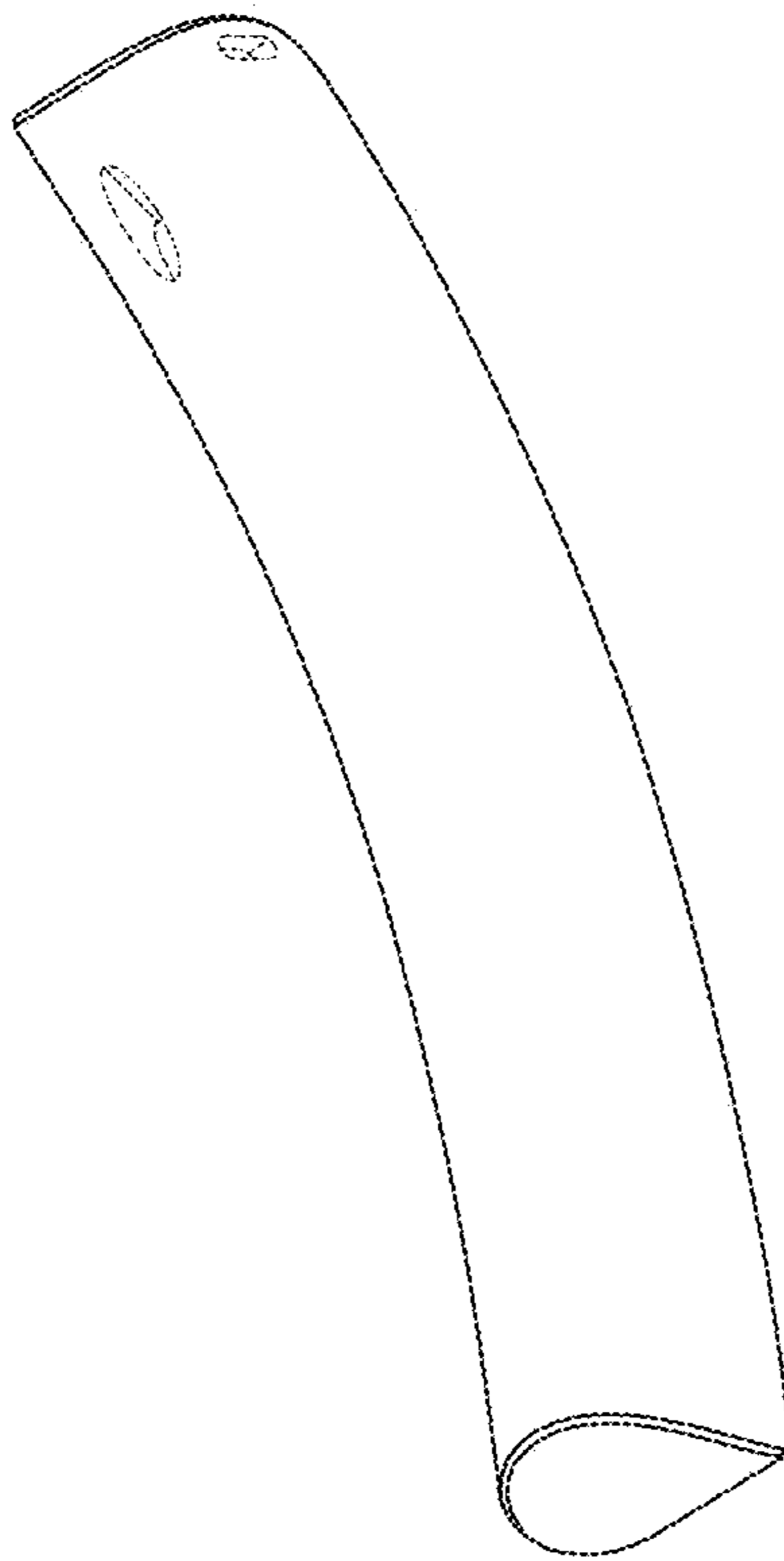

2.8

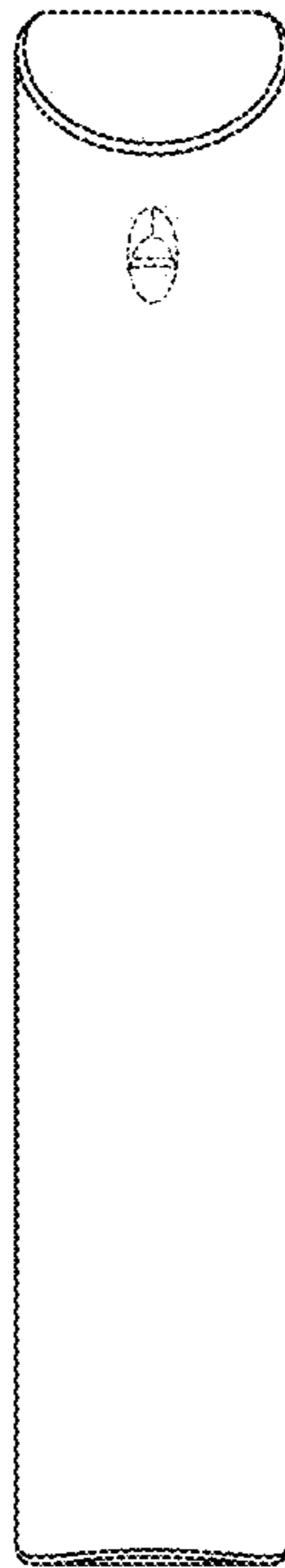

3.1

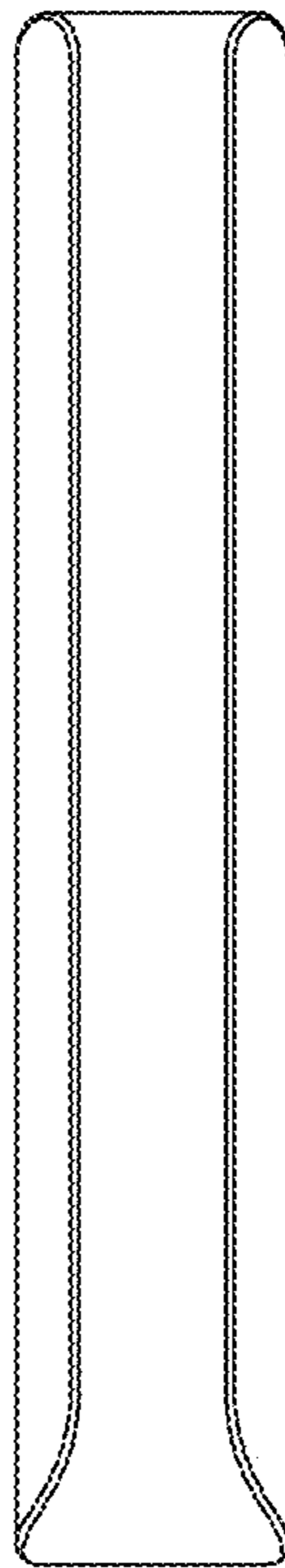

3.2

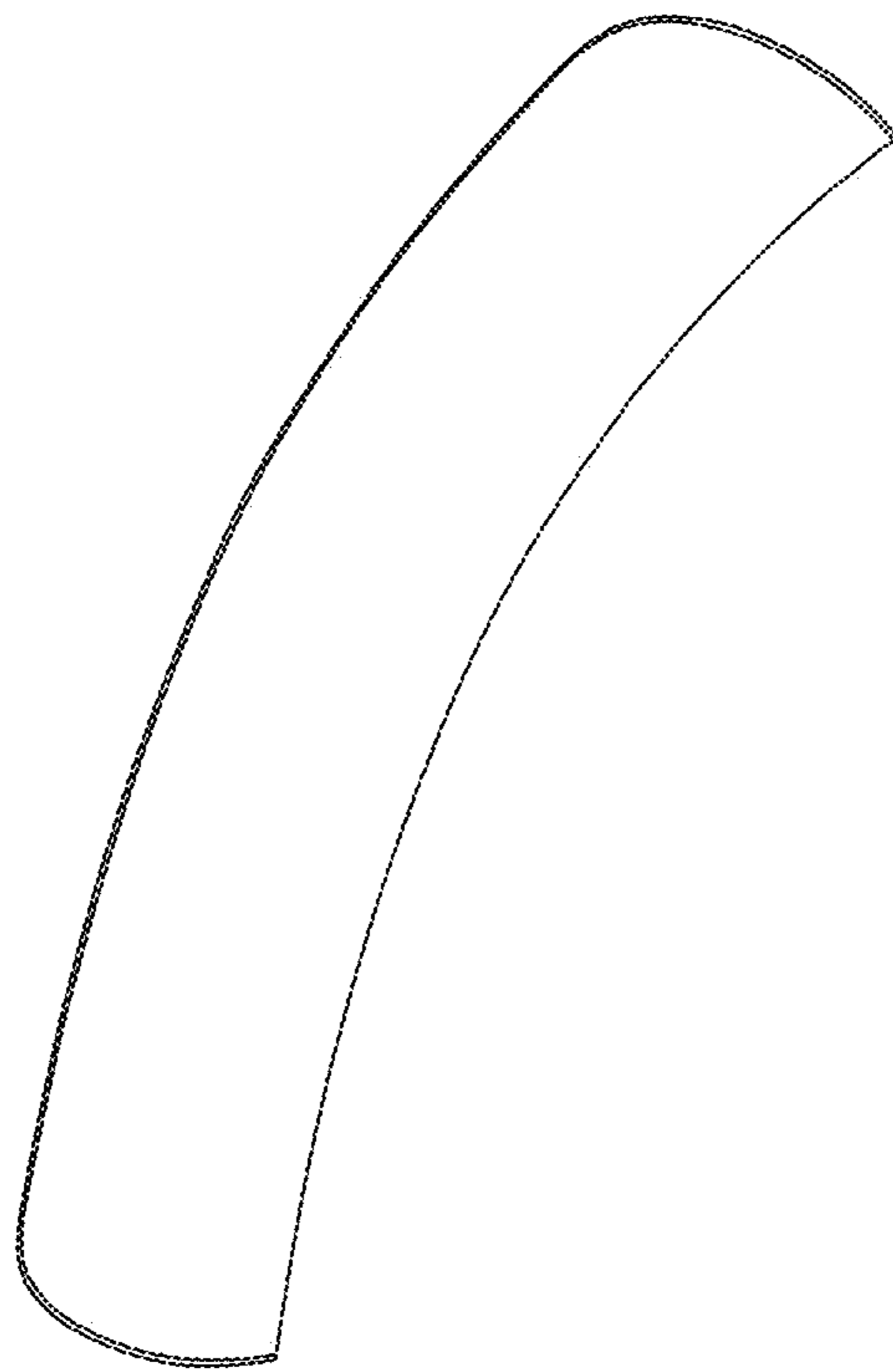

3.3

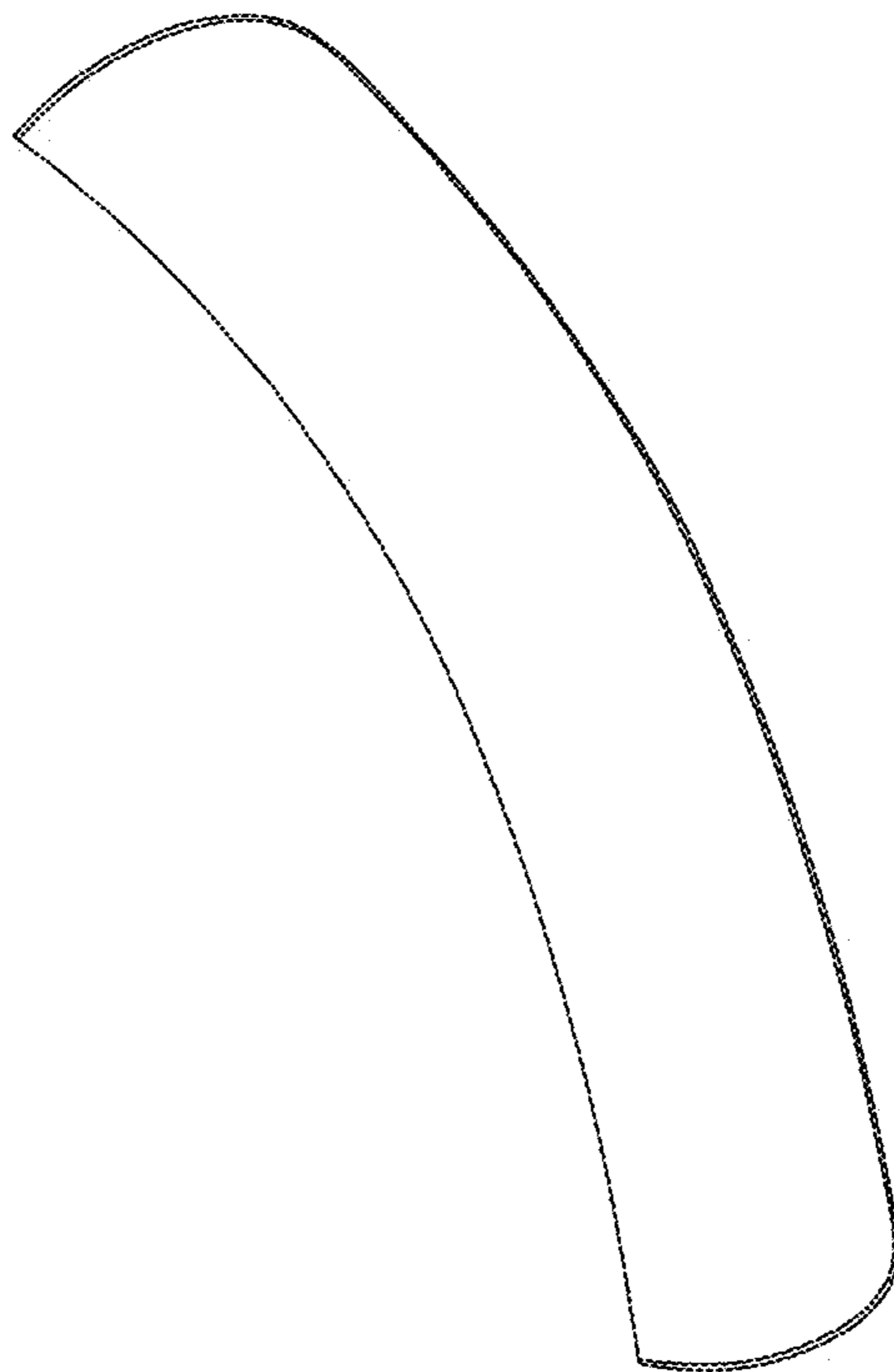

3.4

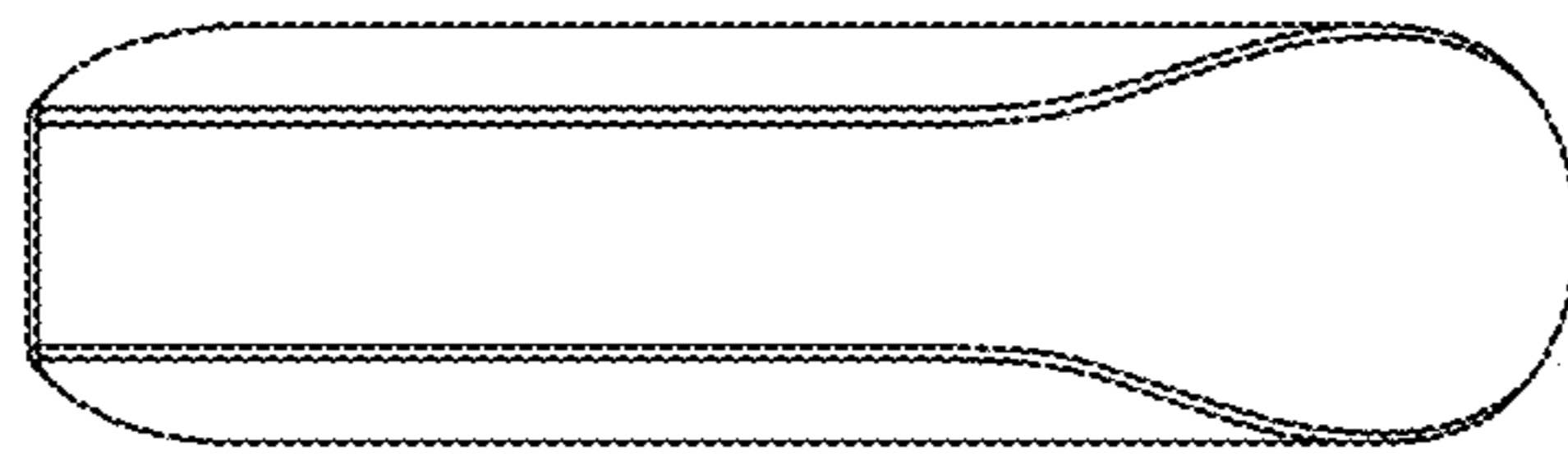

3.5

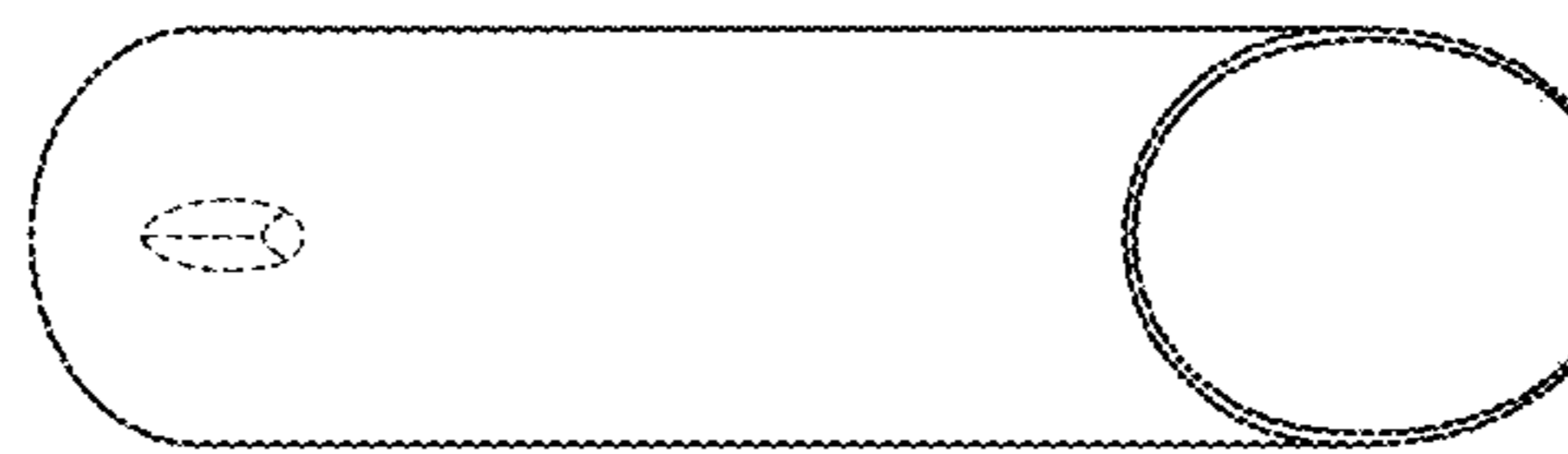

3.6

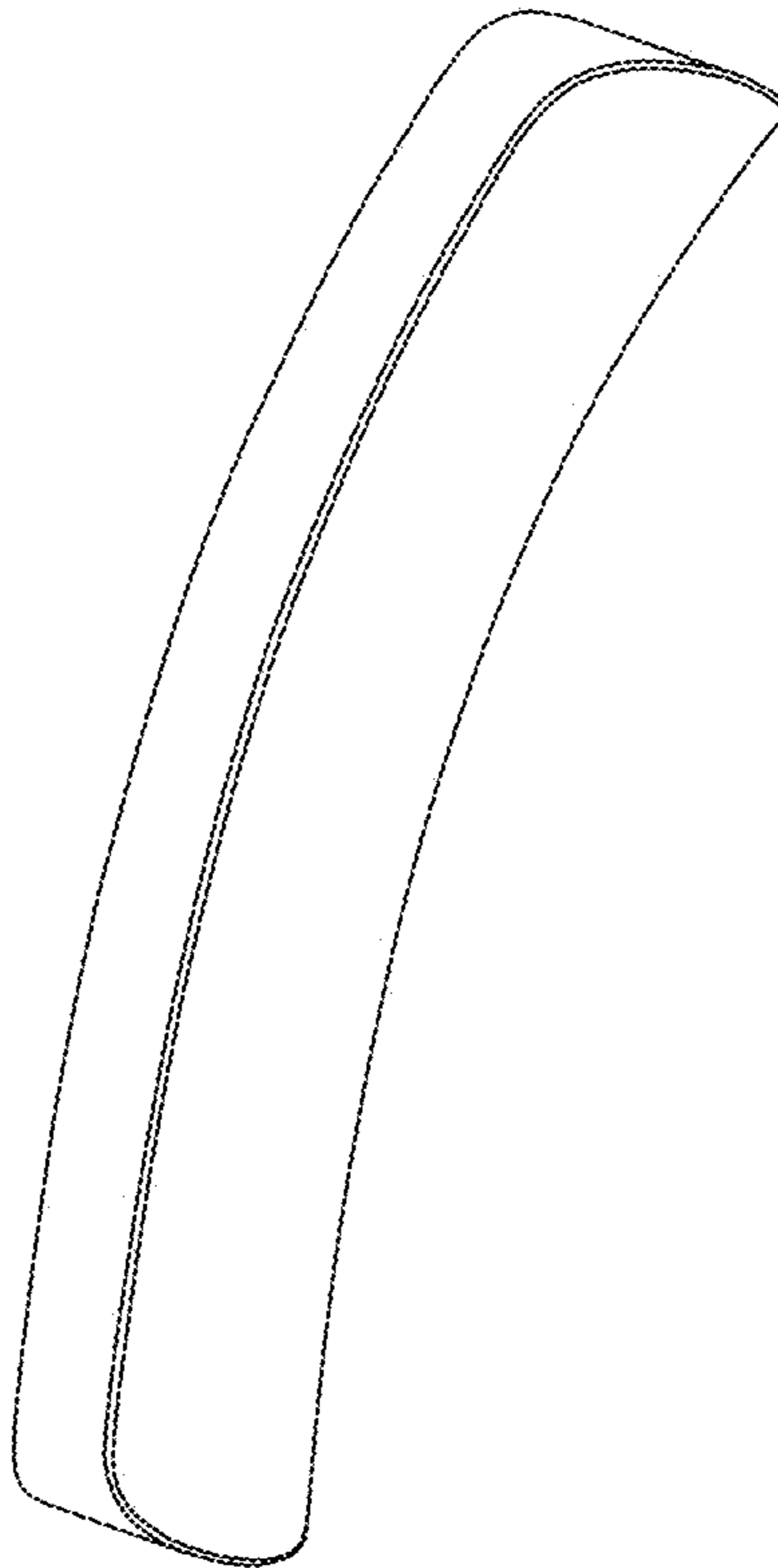



3.7

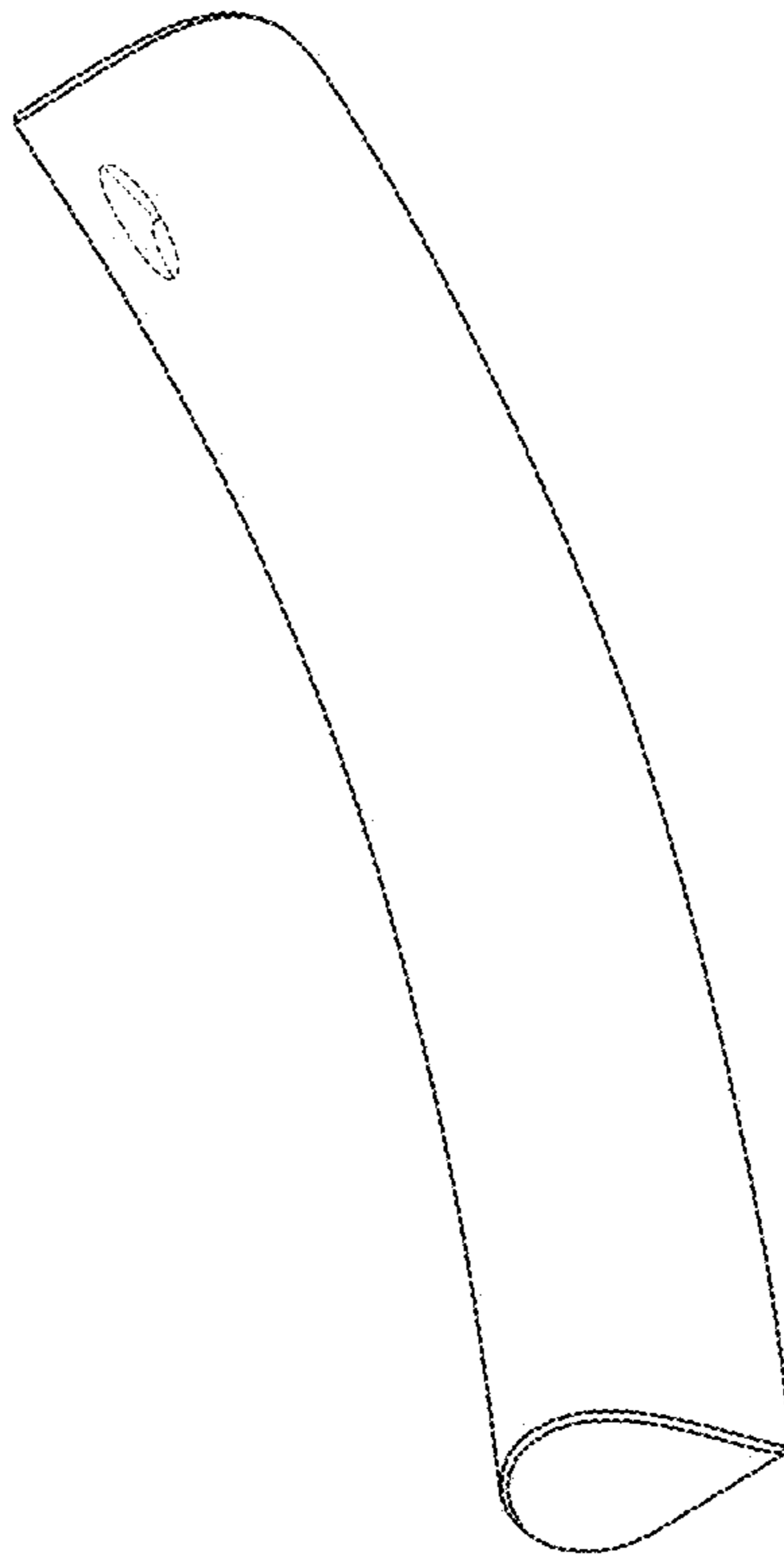

3.8

