



US00D870252S

(12) **United States Design Patent** (10) **Patent No.:** **US D870,252 S**
Vostal et al. (45) **Date of Patent:** **** Dec. 17, 2019**

(54) **FORCED AIR WARMING SYSTEM**

(56) **References Cited**

(71) Applicant: **3M INNOVATIVE PROPERTIES COMPANY**, St. Paul, MN (US)

U.S. PATENT DOCUMENTS

(72) Inventors: **Michael J. Vostal**, Minneapolis, MN (US); **Christopher J. Claypool**, Woodbury, MN (US); **Jared J. Balthazor**, Linwood Township, MN (US)

D445,117 S * 7/2001 Heber D15/79
D652,185 S * 1/2012 Mu D32/21
D676,205 S * 2/2013 Theising D32/21
D771,786 S * 11/2016 Canipe D23/328
2014/0165639 A1* 6/2014 Canipe F24F 5/0035
62/259.4

* cited by examiner

(73) Assignee: **3M Innovative Properties Company**, Saint Paul, MN (US)

Primary Examiner — T Chase Nelson

Assistant Examiner — Ania Aman

(**) Term: **15 Years**

(74) *Attorney, Agent, or Firm* — 3M Innovative Properties Company; Jonathan V. Sry

(21) Appl. No.: **29/639,565**

(22) Filed: **Mar. 7, 2018**

(57) **CLAIM**

(51) **LOC (12) Cl.** **23-03**

The ornamental design for a forced air warming system, as shown and described.

(52) **U.S. Cl.**

USPC **D23/317**; D23/314

(58) **Field of Classification Search**

DESCRIPTION

USPC D23/314, 317, 318, 319, 320, 321, 322, D23/323, 329, 330, 331, 332, 334, 335, D23/333, 336, 337, 338, 339, 340, 341, D23/342, 370, 378, 411, 412, 356, 358, D23/359, 363, 328; D24/127, 128, 129, D24/163, 200, 206, 207, 209, 210, 211; D13/184

CPC F24H 3/00; F24H 3/0411; F24H 3/0417; F24H 9/0063; F24H 9/0073; F24H 9/02; F24H 3/082; F24H 9/2071; F24H 3/002; F24H 3/02; F24H 3/04; F04D 17/04; F04D 25/08; F04D 25/10; F04D 5/00; H05B 3/008; A61F 2007/0098; A61F 7/0097; A61F 7/0085; A61F 7/00

FIG. 1 is a perspective view showing the new design of a forced air warming system;
FIG. 2 is a front view thereof;
FIG. 3 is a back view thereof;
FIG. 4 is a left side view thereof;
FIG. 5 is a right side view thereof;
FIG. 6 is a top view thereof; and,
FIG. 7 is a bottom view thereof.

The portions of the forced air warming system in FIGS. 1-7 shown in broken lines are included to show features that form no part of the claimed design.

See application file for complete search history.

1 Claim, 7 Drawing Sheets

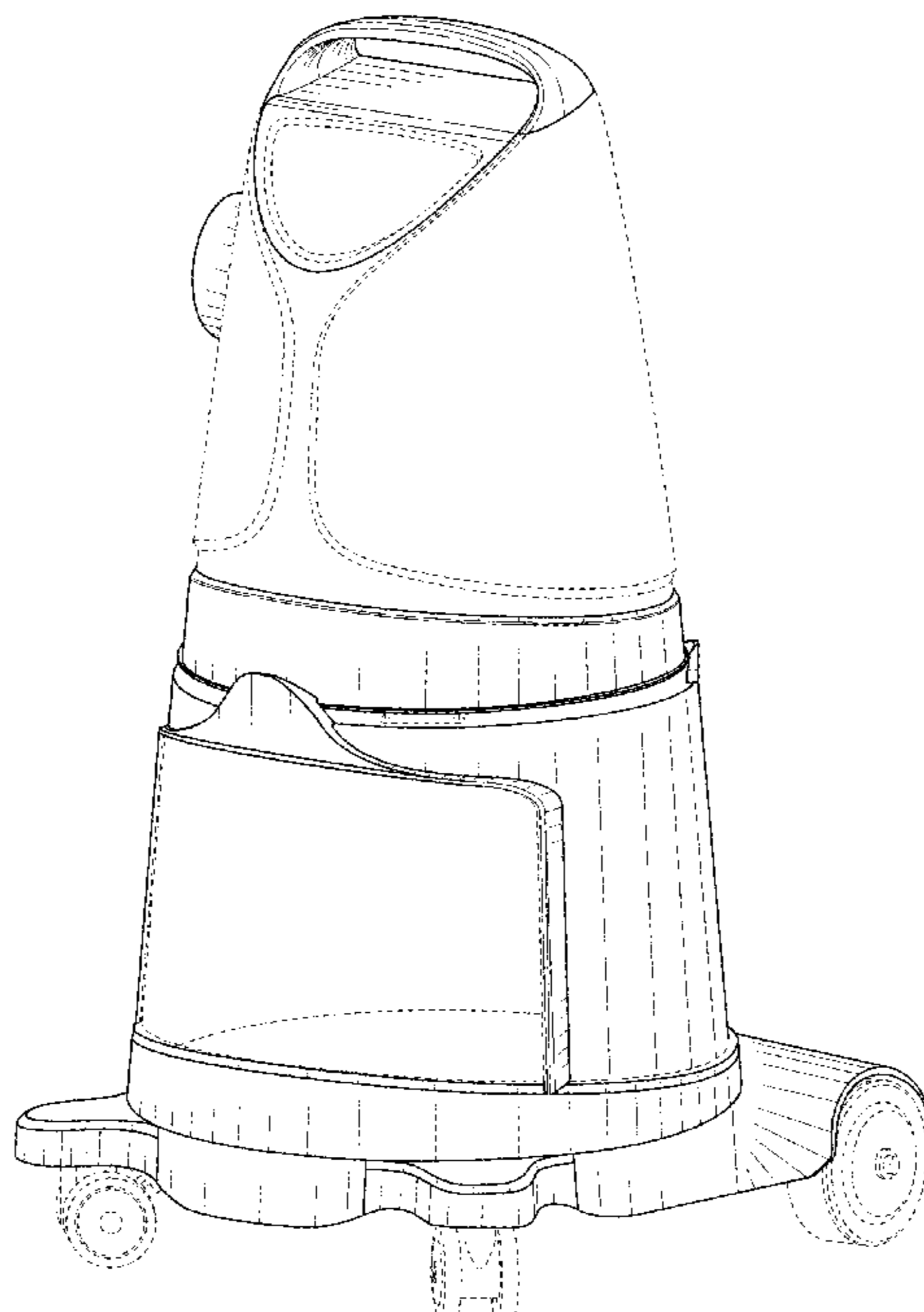

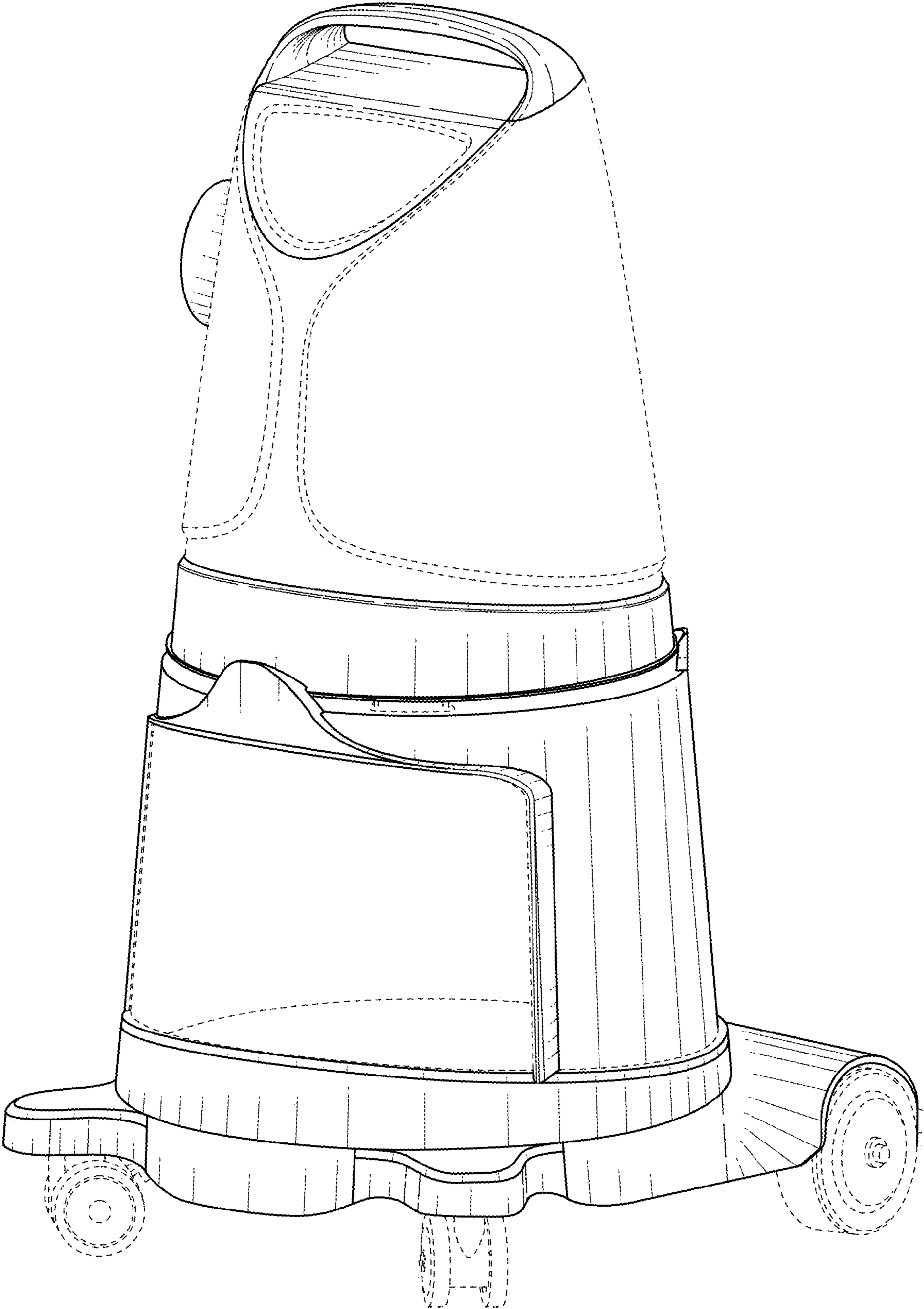

FIG. 1

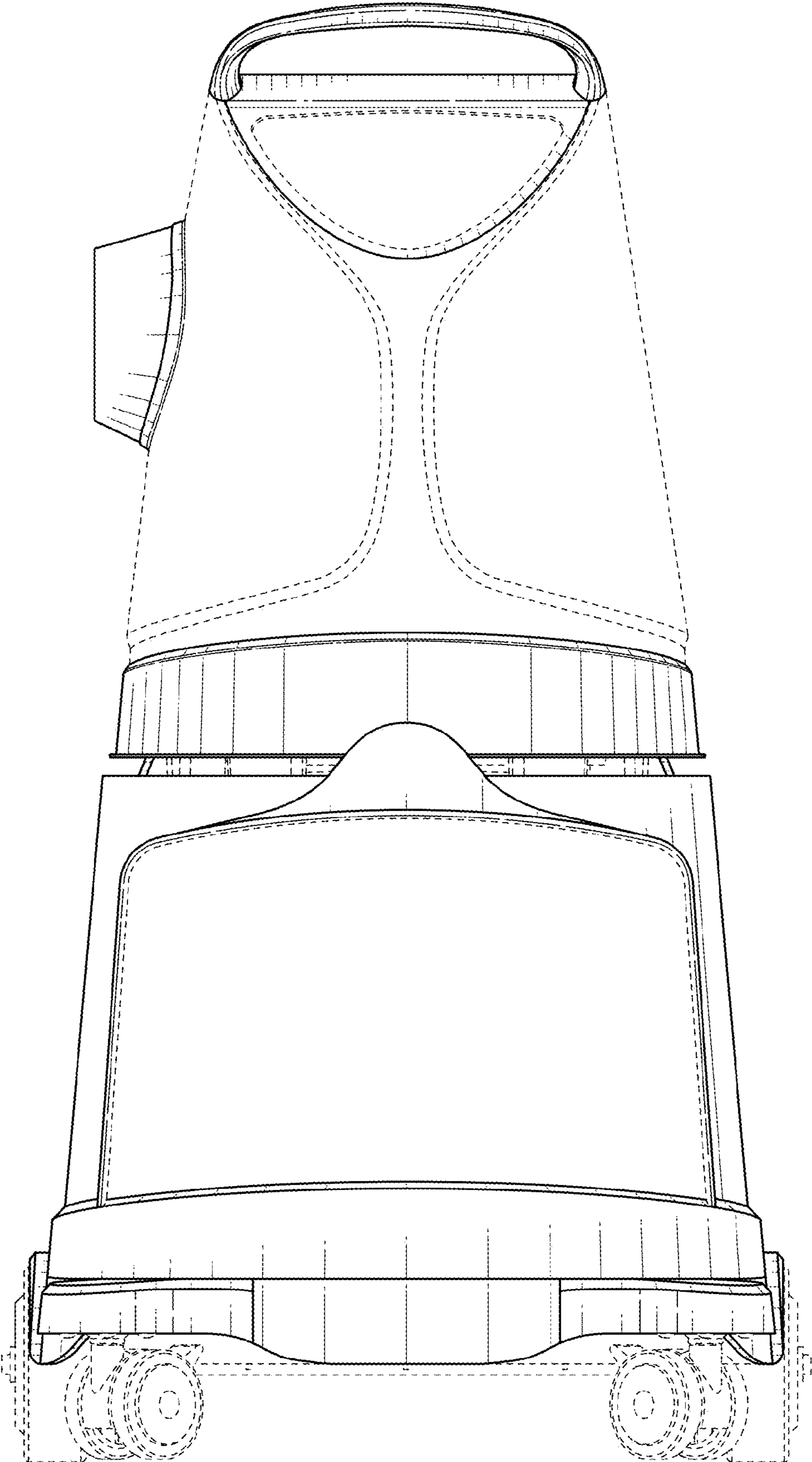

FIG. 2

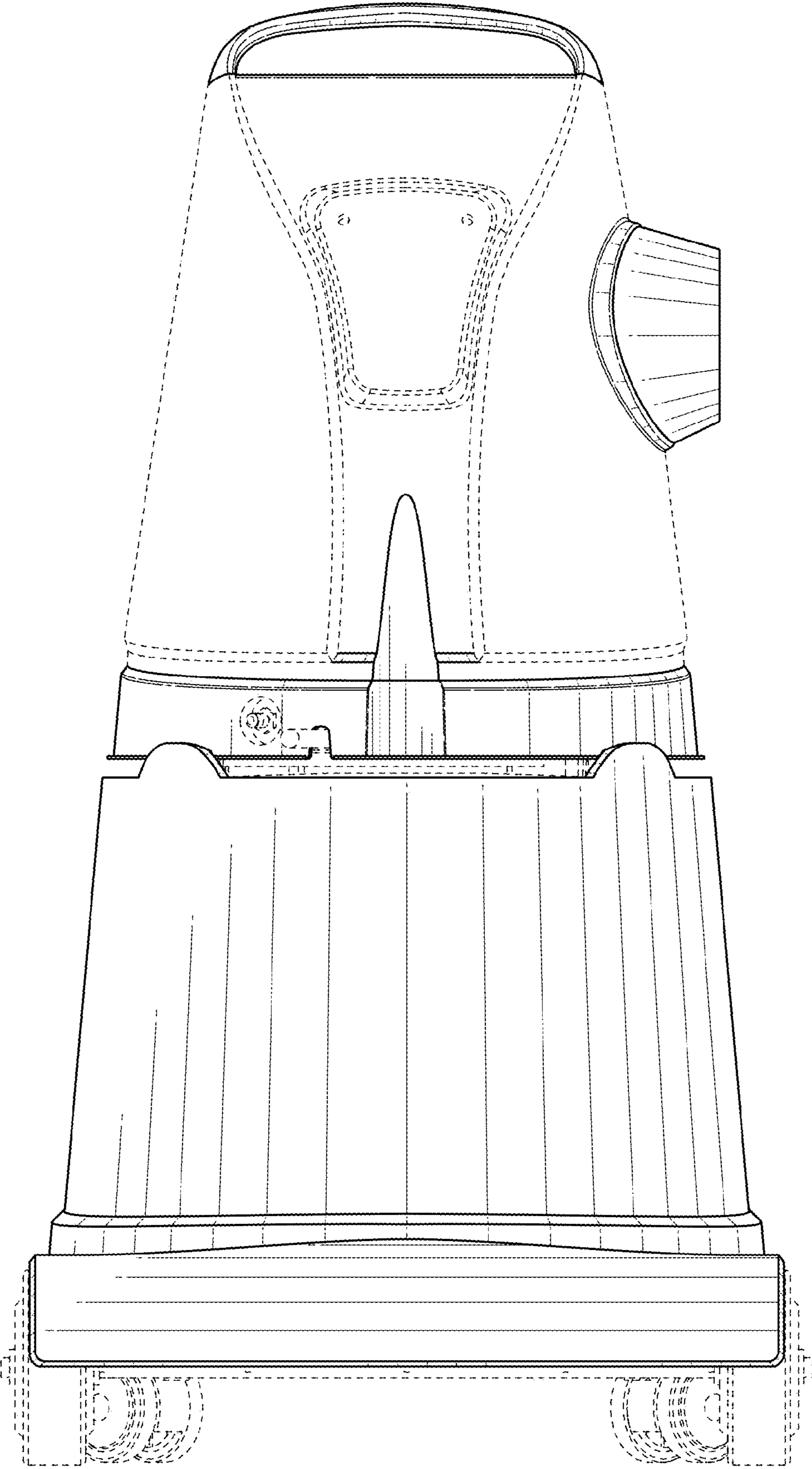

FIG. 3

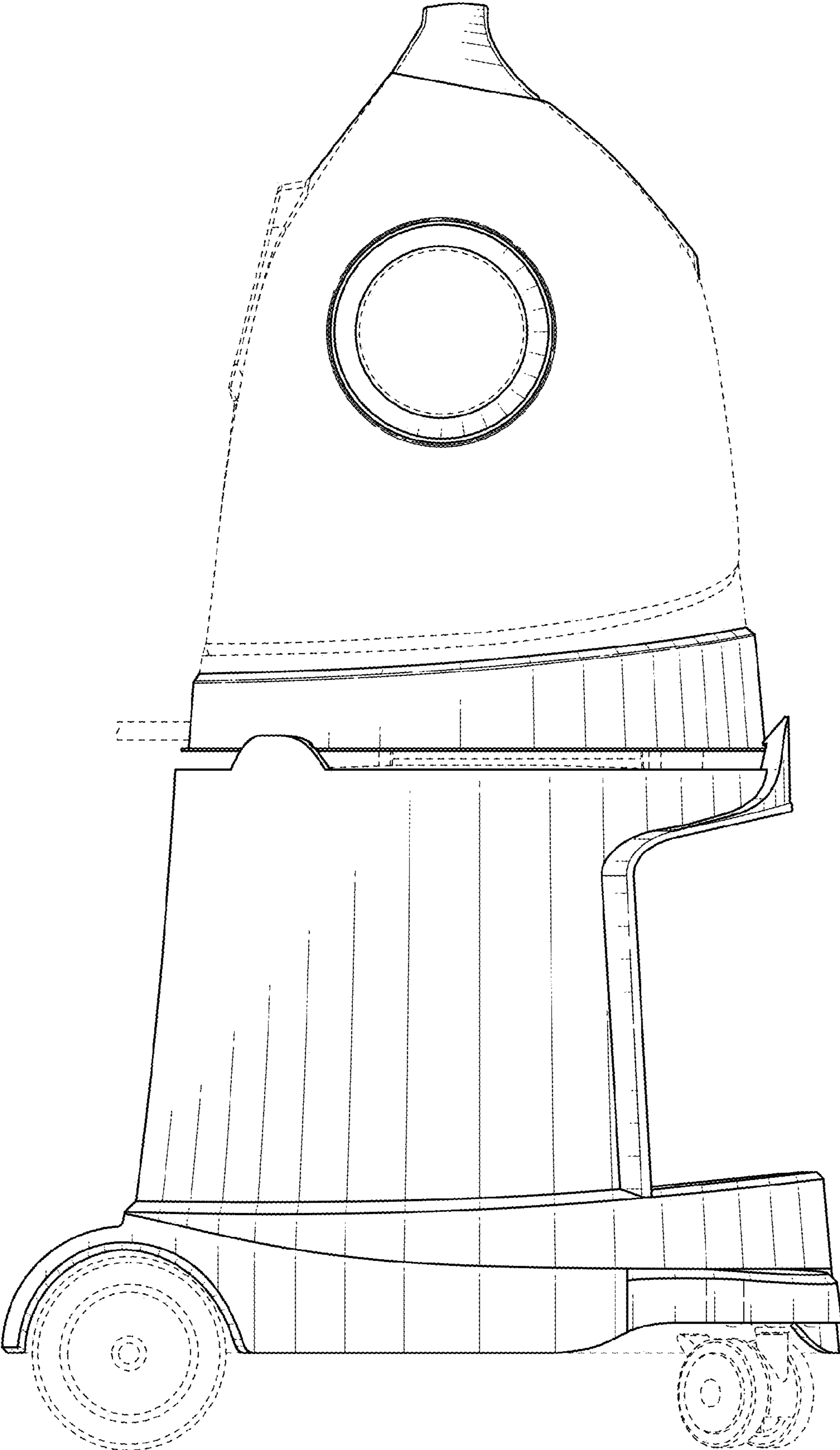

FIG. 4

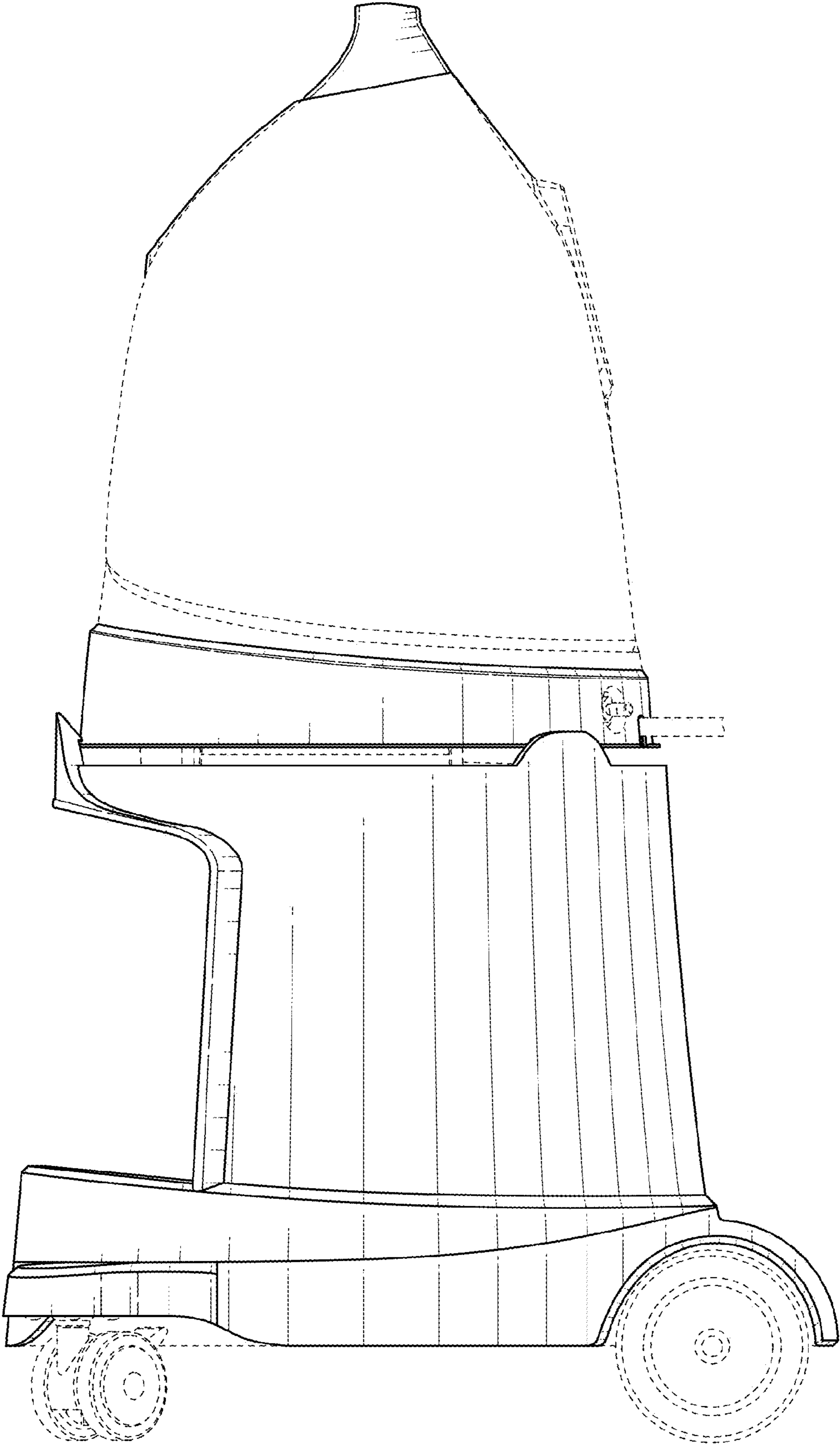

FIG. 5

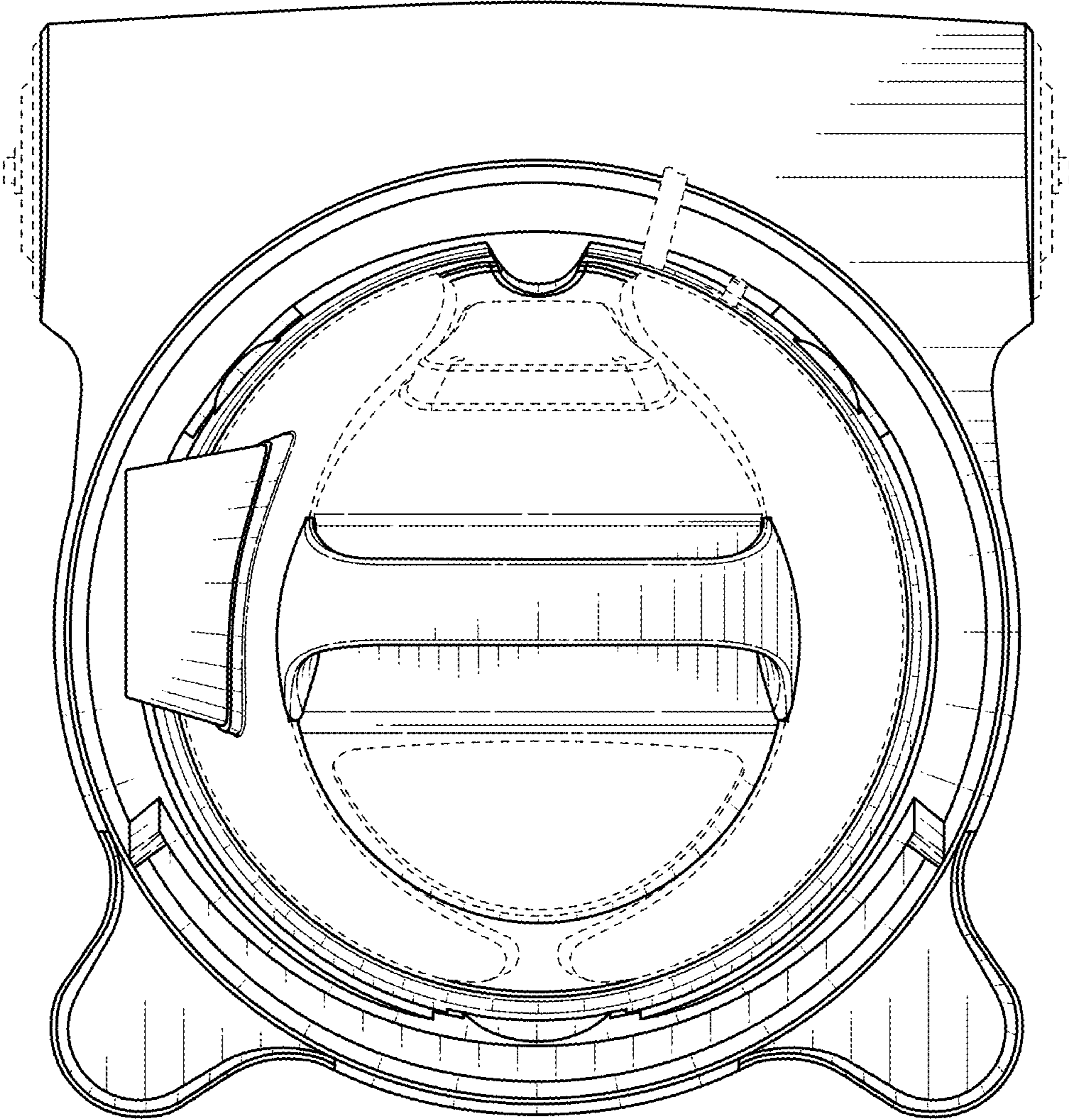

FIG. 6

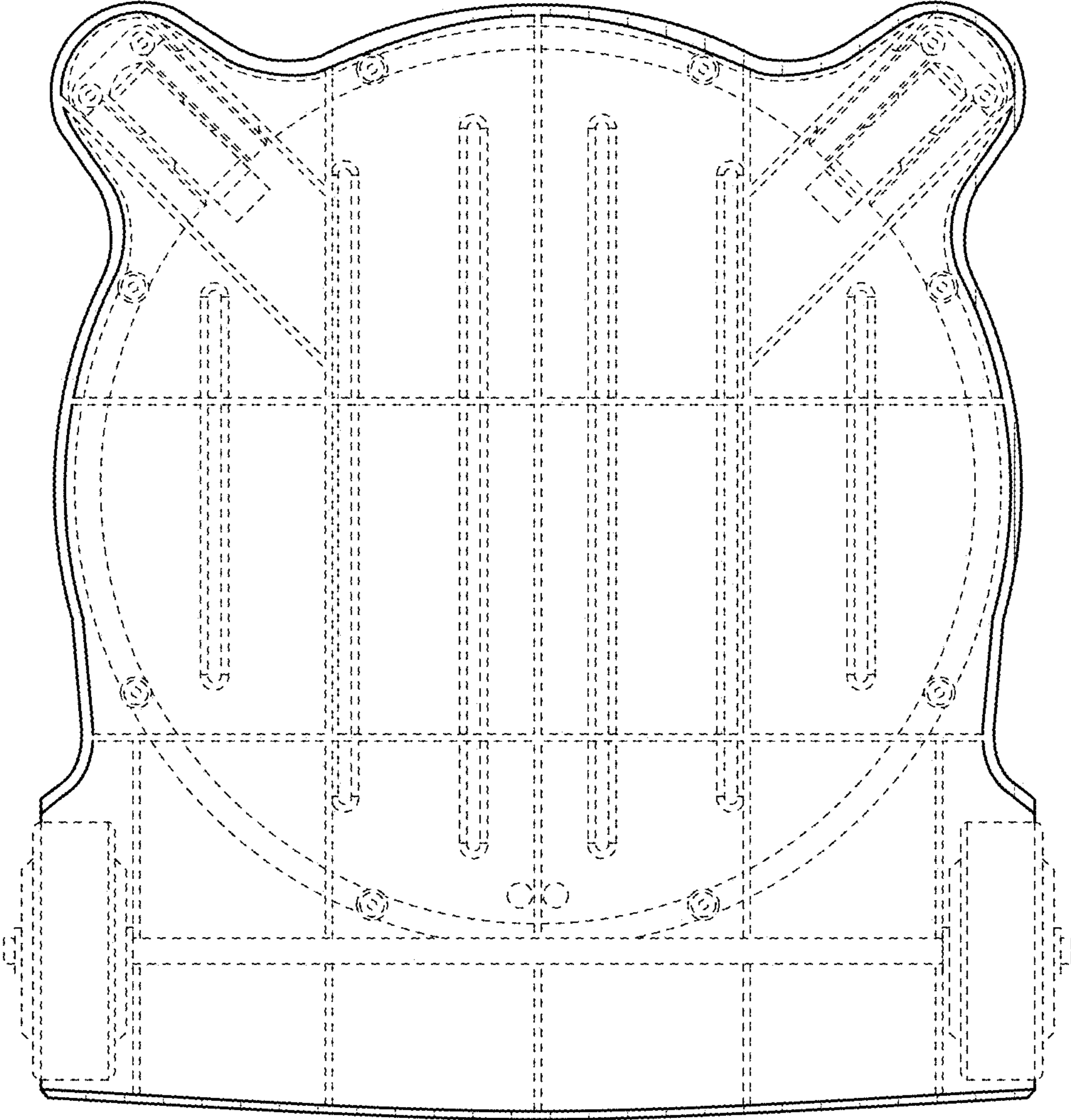

FIG. 7