



US00D870161S

(12) **United States Design Patent** (10) **Patent No.:** **US D870,161 S**  
**Kreuscher** (45) **Date of Patent:** **\*\* Dec. 17, 2019**

(54) **BLAST CHILLER**  
(71) Applicant: **Everidge, Inc.**, Plymouth, MN (US)  
(72) Inventor: **Kenneth E. Kreuscher**, Watertown, WI (US)  
(73) Assignee: **Everidge, Inc.**, Plymouth, MN (US)  
(\*\*) Term: **15 Years**

D649,234 S 11/2011 Iovanel  
D681,181 S 4/2013 Iovanel  
D683,011 S \* 5/2013 Chen ..... D23/370  
8,910,491 B2 12/2014 Iovanel  
9,233,440 B2 1/2016 Iovanel  
D816,821 S \* 5/2018 Tajima ..... D23/354  
2010/0319380 A1 \* 12/2010 Mochizuki ..... F24F 1/06  
62/259.1  
2012/0167608 A1 \* 7/2012 Bae ..... F24F 1/08  
62/296

(21) Appl. No.: **29/628,289**  
(22) Filed: **Dec. 4, 2017**  
(51) **LOC (12) Cl.** ..... **15-07**  
(52) **U.S. Cl.**  
USPC ..... **D15/79**  
(58) **Field of Classification Search**  
USPC ..... D23/385-389, 395, 330, 397, 393, 392,  
D23/370, 351, 354; D15/79-91  
CPC ..... F24F 2110/10; F24F 11/30; F24F 11/56;  
F24F 11/62; F24F 2110/12; F24F  
2110/50; F24F 2140/40; F24F 11/46;  
F24F 11/52; F24F 11/58; F24F 11/61;  
F24F 11/64; F24F 11/65; F24F 11/70;  
F24F 13/0254; F24F 13/08; F24F 13/081;  
F24F 1/0007; F24F 1/0018; F24F  
2110/00; F24F 2110/20; F24F 2120/20;  
F24F 2130/10; F24F 2130/20; F24F  
2221/34; F24F 5/0096  
See application file for complete search history.

**OTHER PUBLICATIONS**

“AP46BC-1T Modular Blast Chiller,” American Panel product sheets, printed Apr. 5, 2016, 2 pages.  
“AP46BCF-2T,” American Panel product sheets, printed Apr. 5, 2016, 2 pages.  
“ThermalRite Blast Chillers and Blast Freezers Offer,” CypenVac Insulation Technology product sheets, 2015, 8 pages.

\* cited by examiner

*Primary Examiner* — Khawaja Anwar

(57) **CLAIM**

The ornamental design for a blast chiller, as shown and described.

**DESCRIPTION**

FIG. 1 is an isometric view from a first, side perspective of a blast chiller;  
FIG. 2 is a first side view thereof;  
FIG. 3 is a second side view thereof;  
FIG. 4 is a third side view thereof;  
FIG. 5 is a fourth side view thereof;  
FIG. 6 is a top side view thereof; and,  
FIG. 7 is a bottom side view thereof.  
Broken lines are also for illustrative purposes only and form no part of the claimed design.

**1 Claim, 6 Drawing Sheets**

(56) **References Cited**  
U.S. PATENT DOCUMENTS

D508,118 S \* 8/2005 Motonishi ..... D23/351  
D534,267 S \* 12/2006 Andersen ..... D23/370  
D600,338 S \* 9/2009 Chung ..... D23/370  
D605,271 S \* 12/2009 Sata ..... D23/351  
D617,887 S \* 6/2010 Sata ..... D23/351  
D628,685 S \* 12/2010 Aoyama ..... D23/351

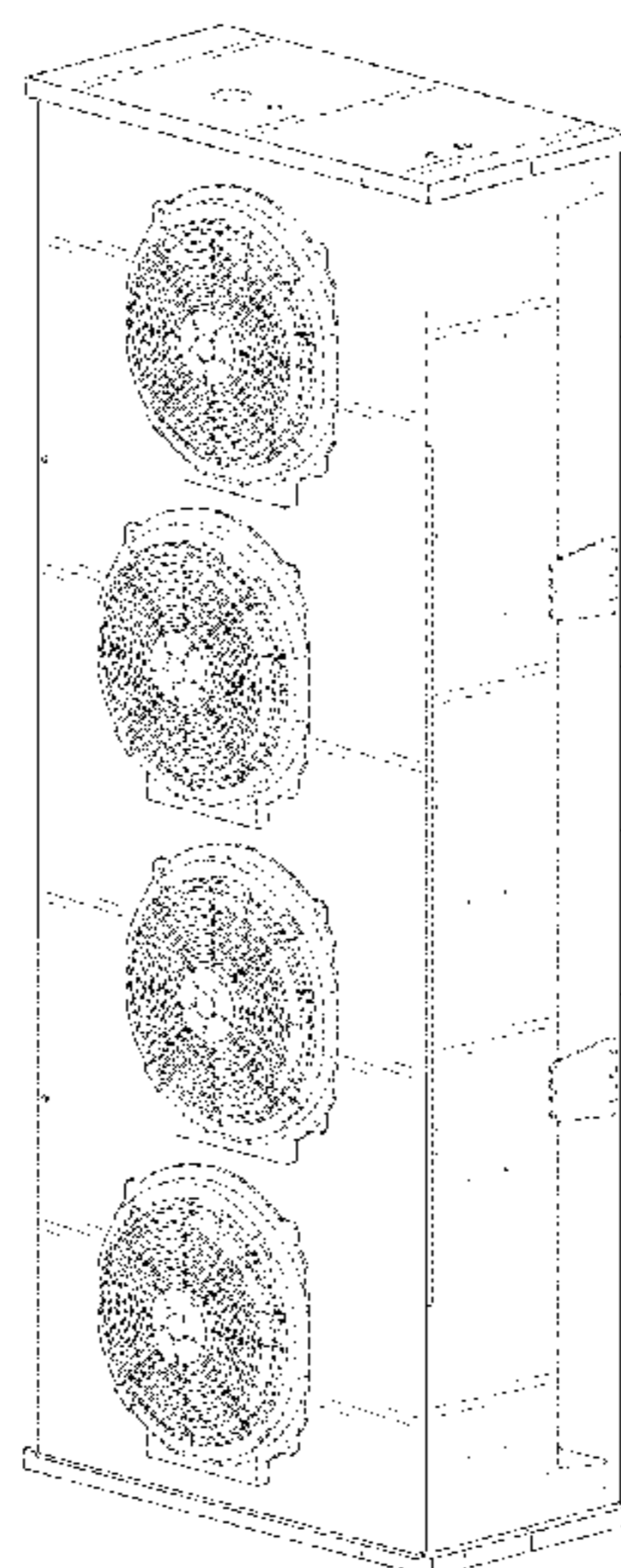

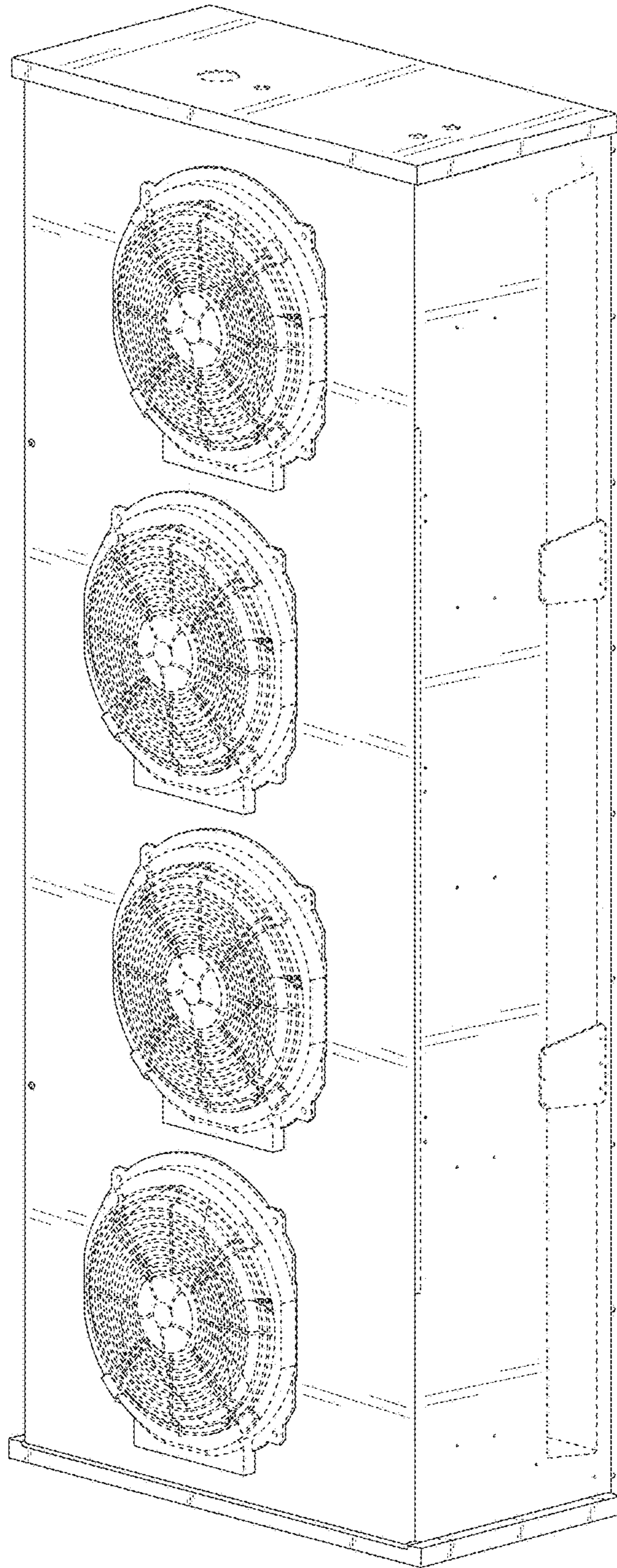

FIG. 1



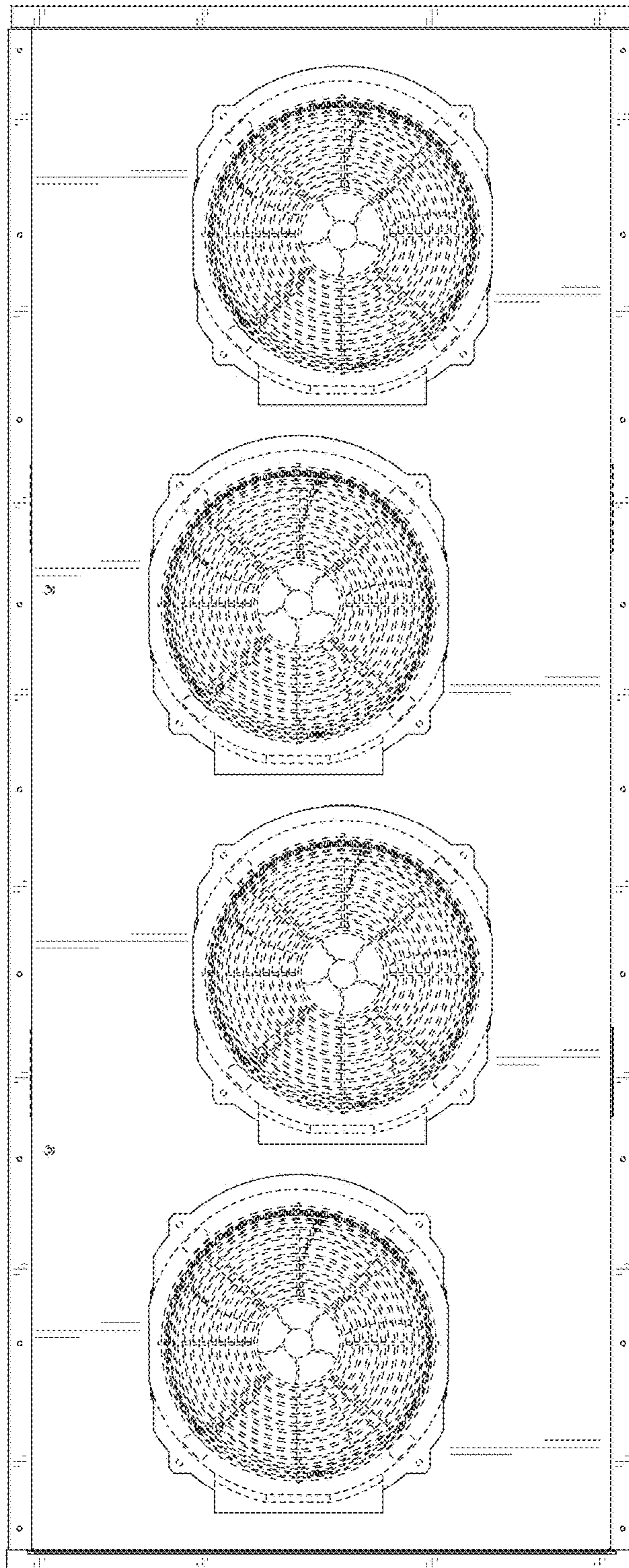

FIG. 2



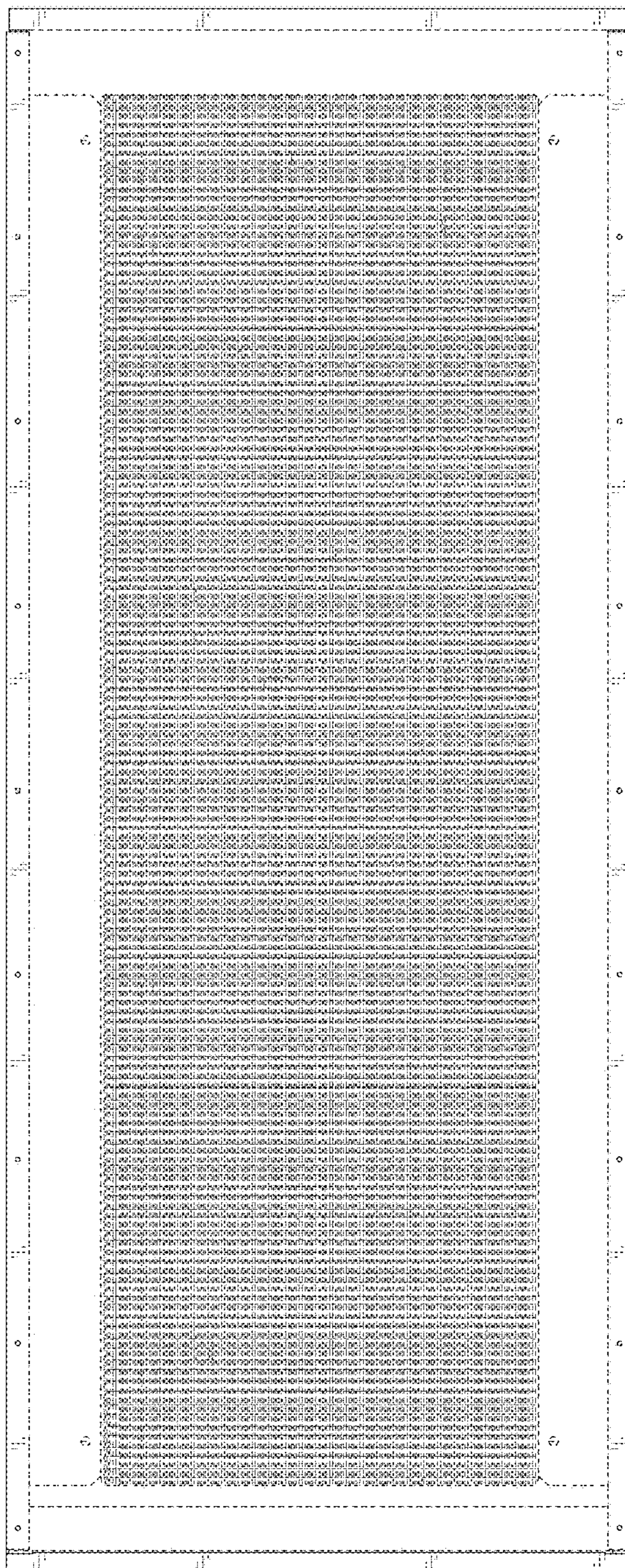

FIG. 3

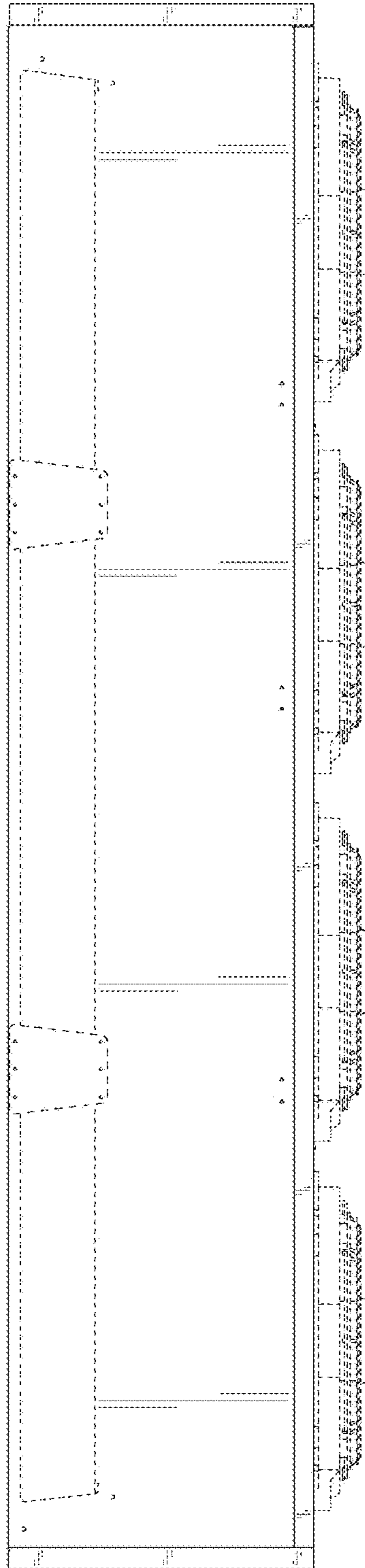

FIG. 4

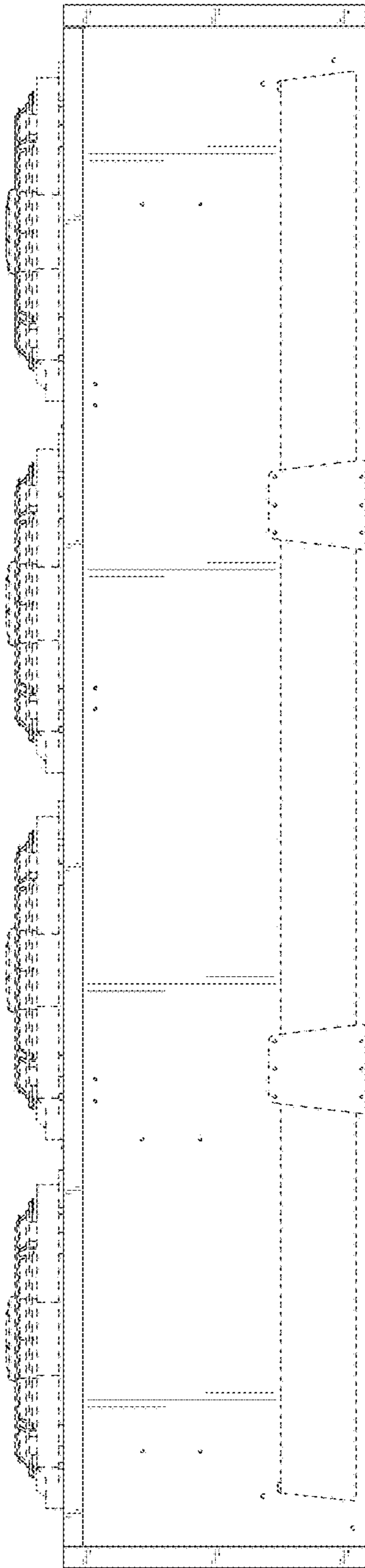

FIG. 5



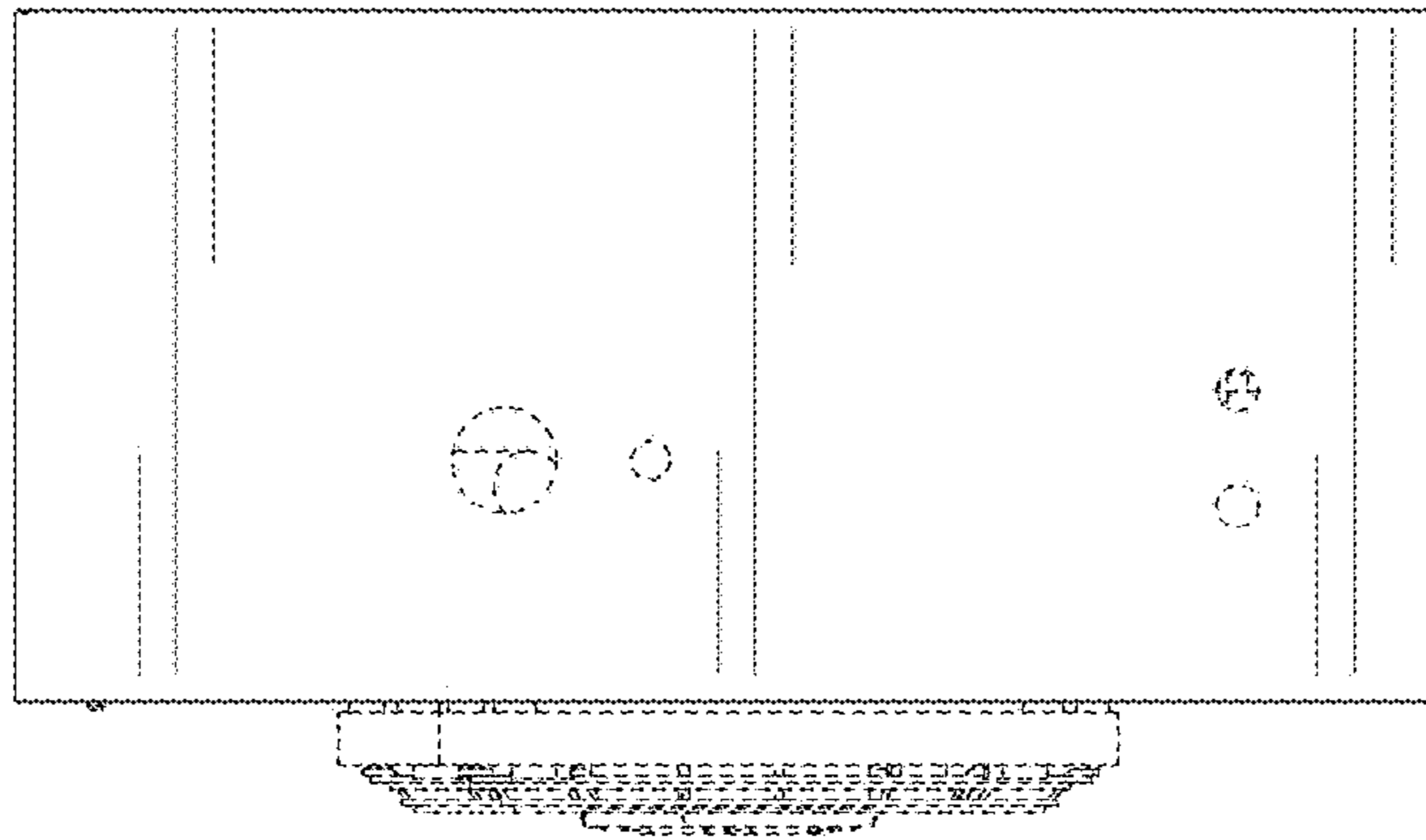

FIG. 6

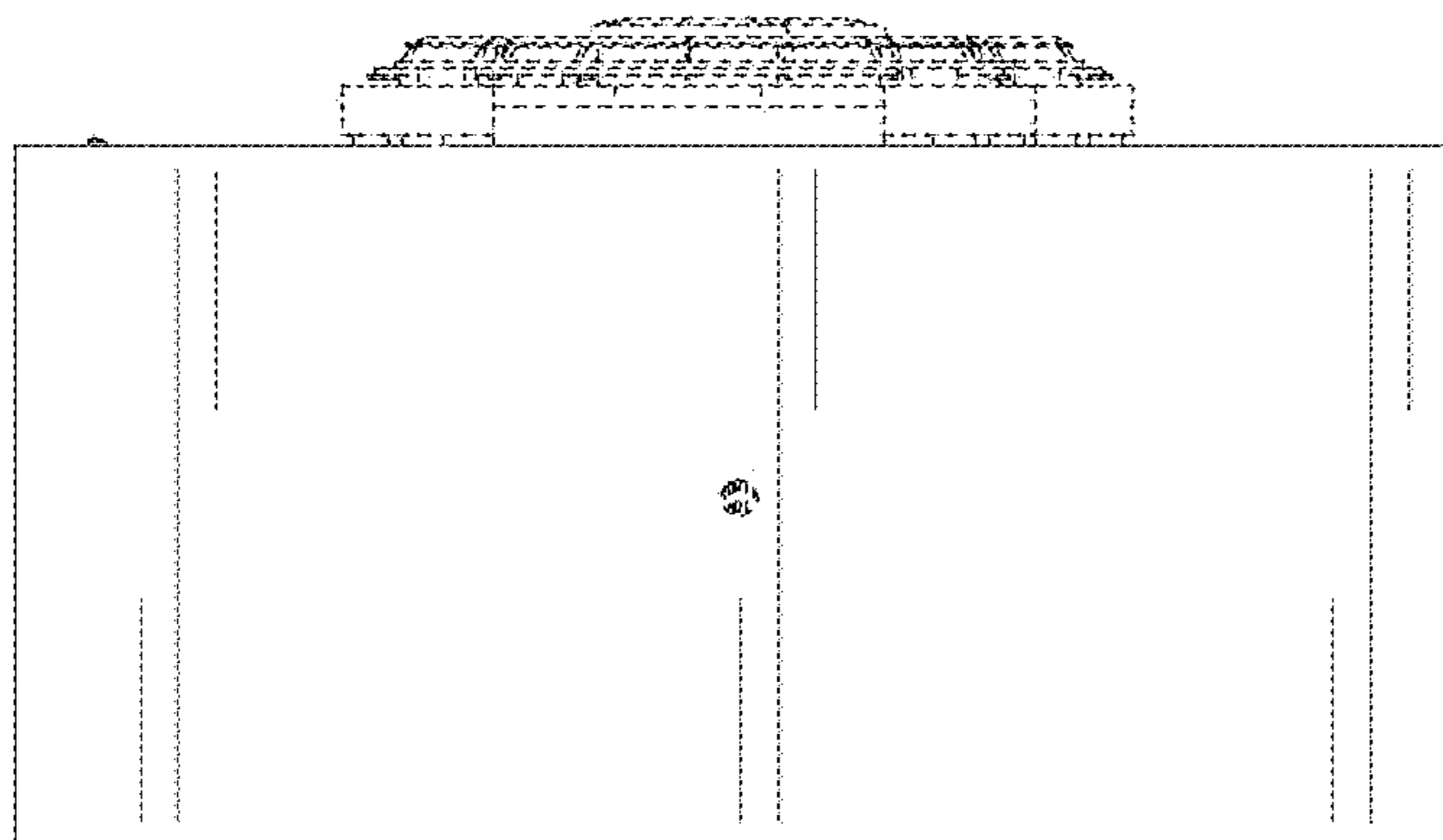

FIG. 7