



US00D86991S

(12) **United States Design Patent**
Dewitt et al.

(10) **Patent No.:** **US D869,991 S**
(45) **Date of Patent:** **** Dec. 17, 2019**

- (54) **VEHICLE EXTERIOR**
- (71) Applicant: **Ford Global Technologies, LLC**,
Dearborn, MI (US)
- (72) Inventors: **David Dewitt**, Docklands (AU); **Todd Willing**, East Melbourne (AU); **Max Wolff**, Birmingham, MI (US)
- (73) Assignee: **Ford Global Technologies, LLC**,
Dearborn, MI (US)
- (**) Term: **15 Years**
- (21) Appl. No.: **29/632,616**
- (22) Filed: **Jan. 9, 2018**
- (51) **LOC (12) Cl.** **12-08**
- (52) **U.S. Cl.**
USPC **D12/98**
- (58) **Field of Classification Search**
USPC D12/86, 90-92, 88, 98; D21/424, 433,
D21/434, 533; 296/181.1, 181.5, 181.3,
296/183.1, 37.6
CPC B60R 9/06; B62D 35/00
See application file for complete search history.

| | | | | |
|--------------|--------|--------|-------|--------|
| D759,545 S * | 6/2016 | Sato | | D12/98 |
| D760,121 S * | 6/2016 | Sato | | D12/98 |
| D763,738 S * | 8/2016 | Dewitt | | D12/98 |
| D764,980 S * | 8/2016 | Platto | | D12/98 |
| D775,551 S * | 1/2017 | Platto | | D12/98 |
| D809,428 S * | 2/2018 | Platto | | D12/98 |
| D809,429 S * | 2/2018 | Platto | | D12/98 |
| D811,274 S * | 2/2018 | Platto | | D12/98 |

* cited by examiner

Primary Examiner — Melody N Brown

(57) **CLAIM**

The ornamental design for a vehicle exterior, as shown and described.

DESCRIPTION

FIG. 1 is a front elevational view of a vehicle exterior showing our new design;
 FIG. 2 is a rear elevational view thereof;
 FIG. 3 is a left side elevational view thereof;
 FIG. 4 is a right side elevational view thereof;
 FIG. 5 is a top plan view thereof;
 FIG. 6 is a top, front, and left side perspective view thereof; and,
 FIG. 7 is a top, rear, and left side perspective view thereof.
 The portions of the vehicle shown throughout the drawing views and deemphasized in half-tone portions outside the broken lines and the broken lines representing the boundary and configuration of what is claimed as the design are for environmental and illustrative purposes that form no part of the claimed design.

1 Claim, 7 Drawing Sheets

- (56) **References Cited**
U.S. PATENT DOCUMENTS
D703,586 S * 4/2014 Platto D12/98
D718,190 S * 11/2014 Platto D12/98
D755,679 S * 5/2016 Sato D12/98

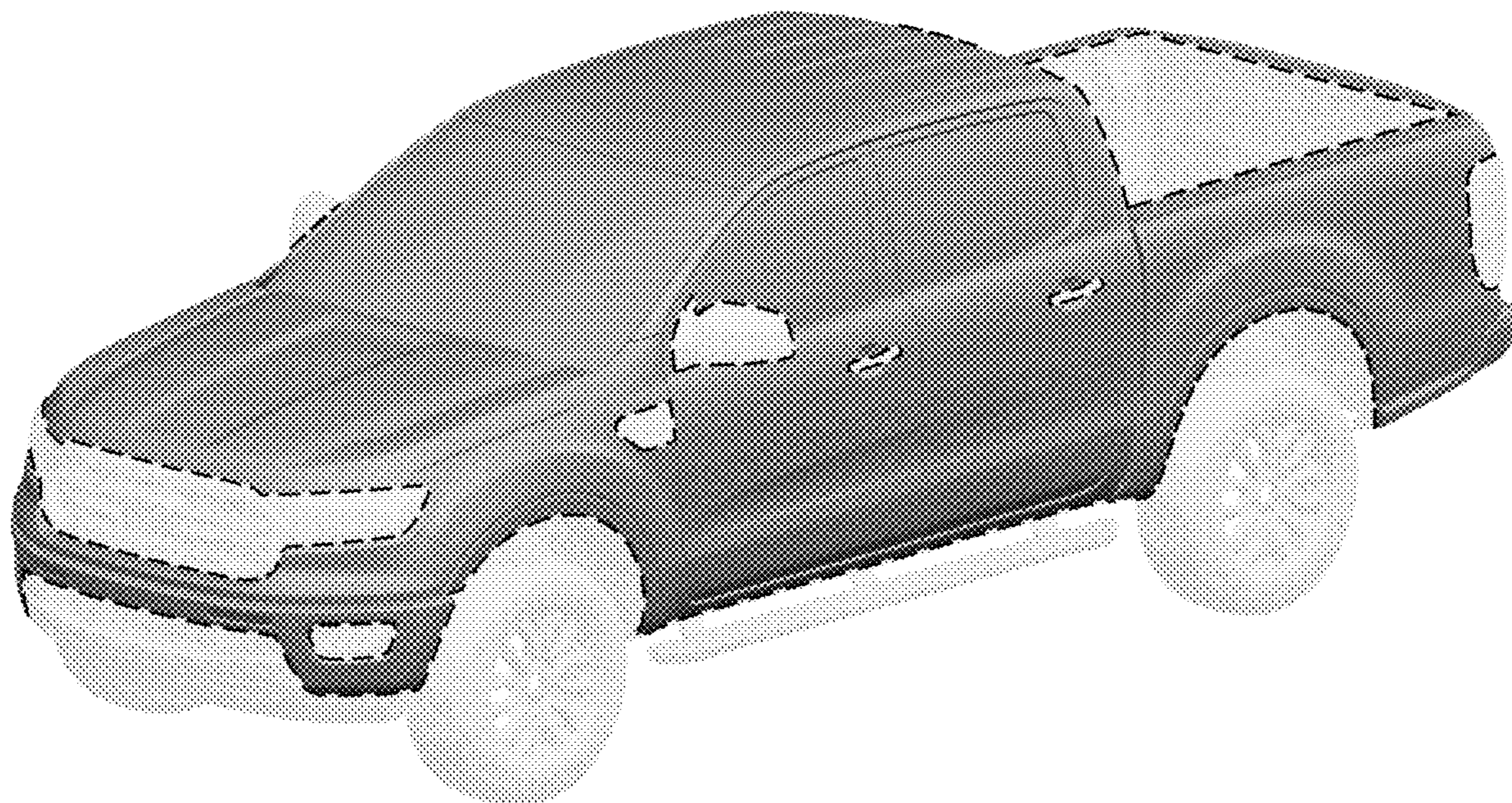

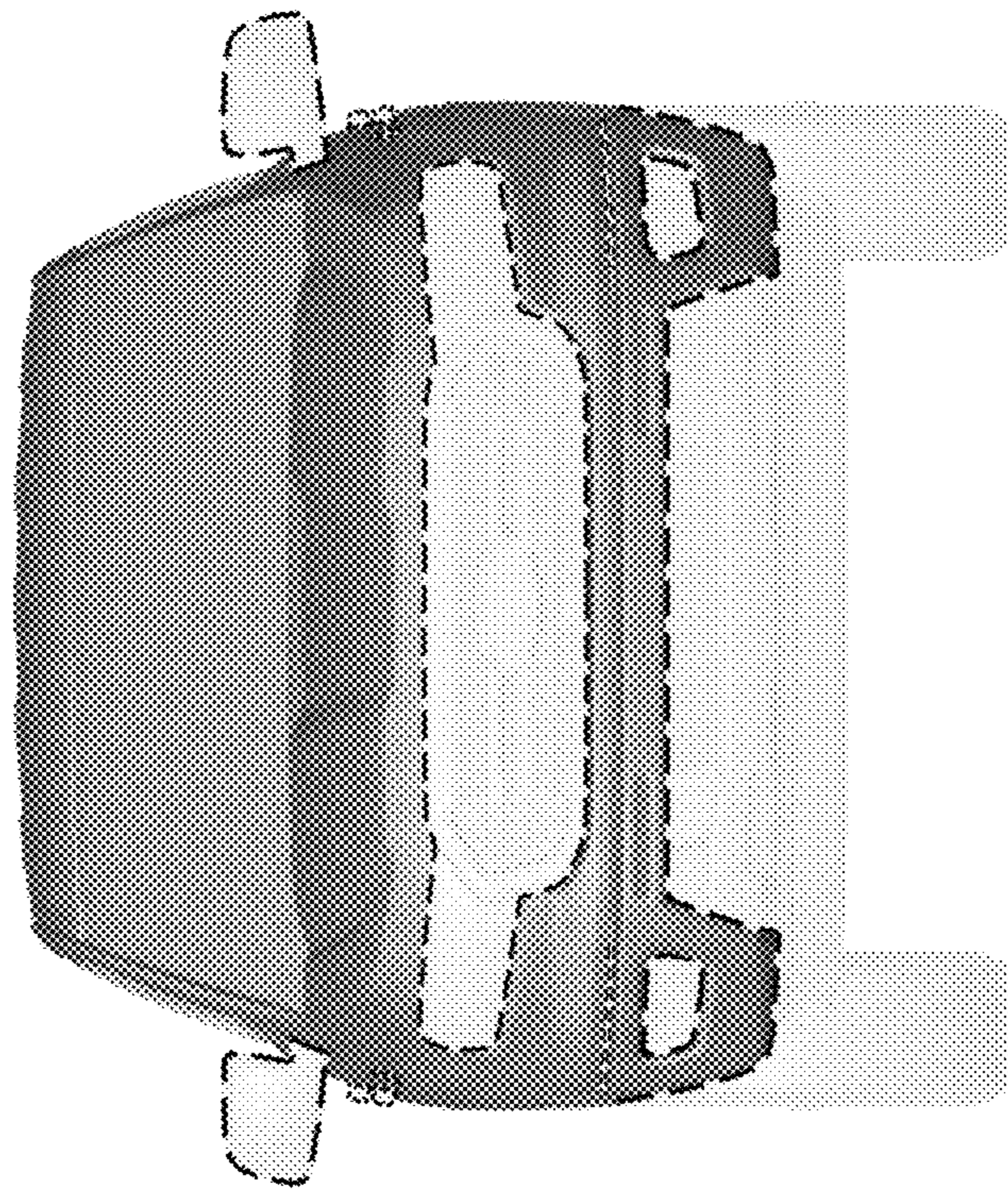

Fig. 1

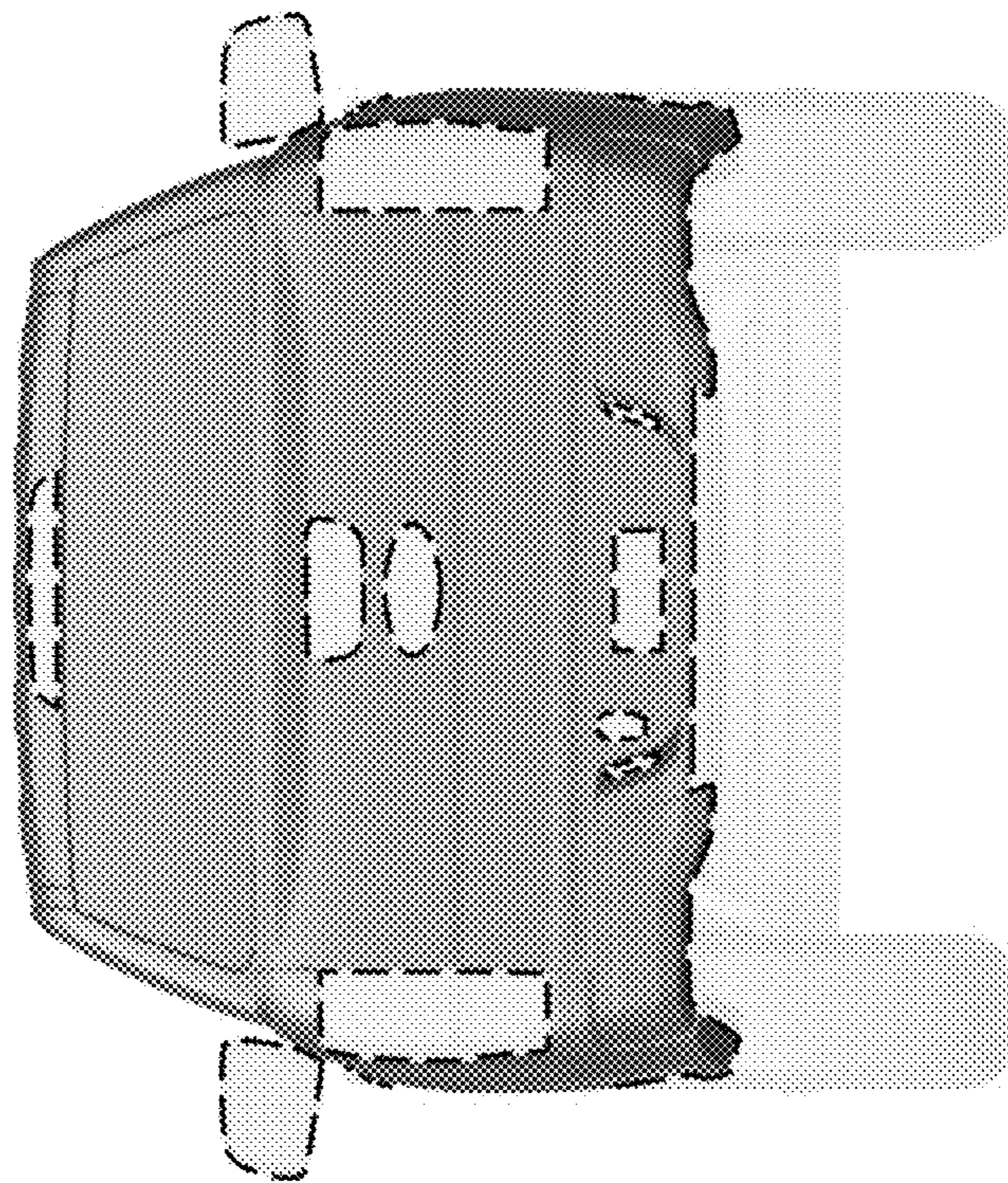

Fig. 2

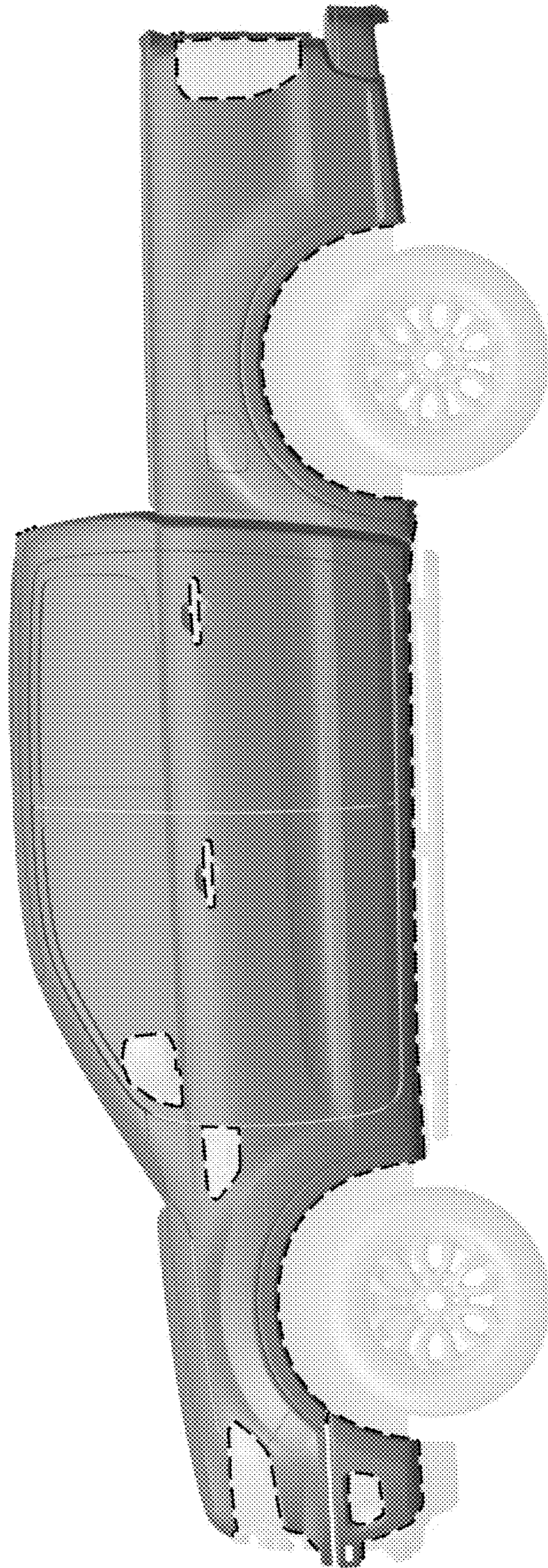

Fig. 3

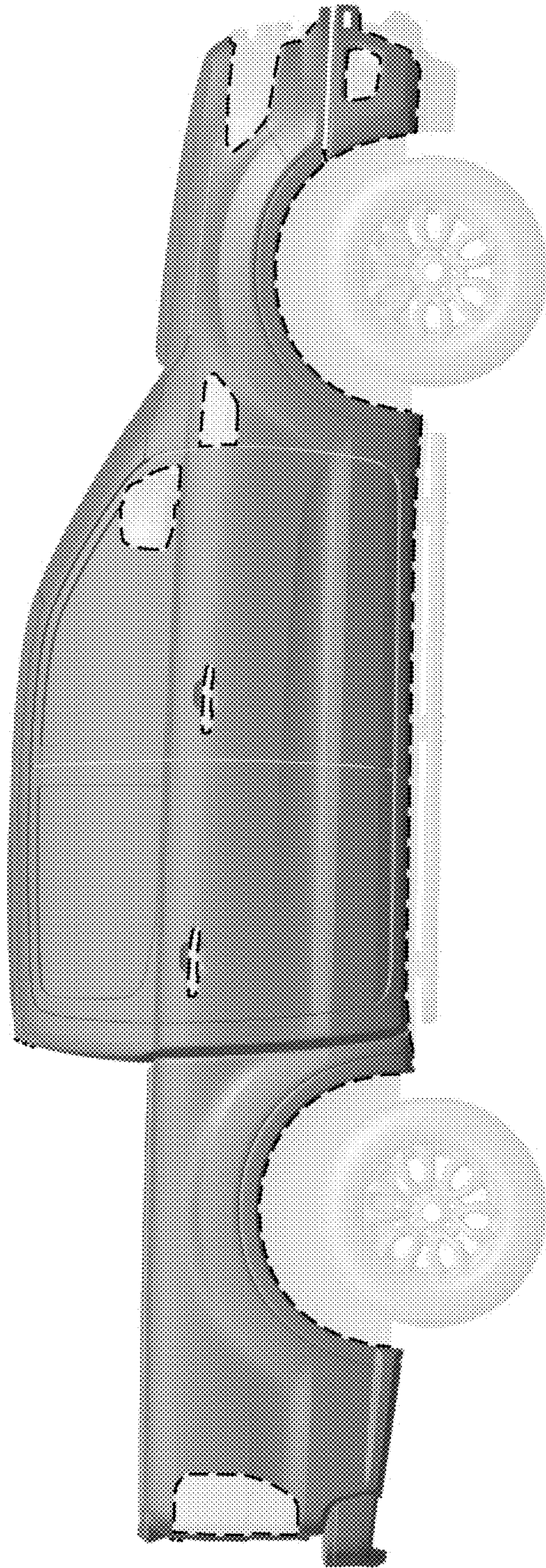

Fig. 4



Fig. 5

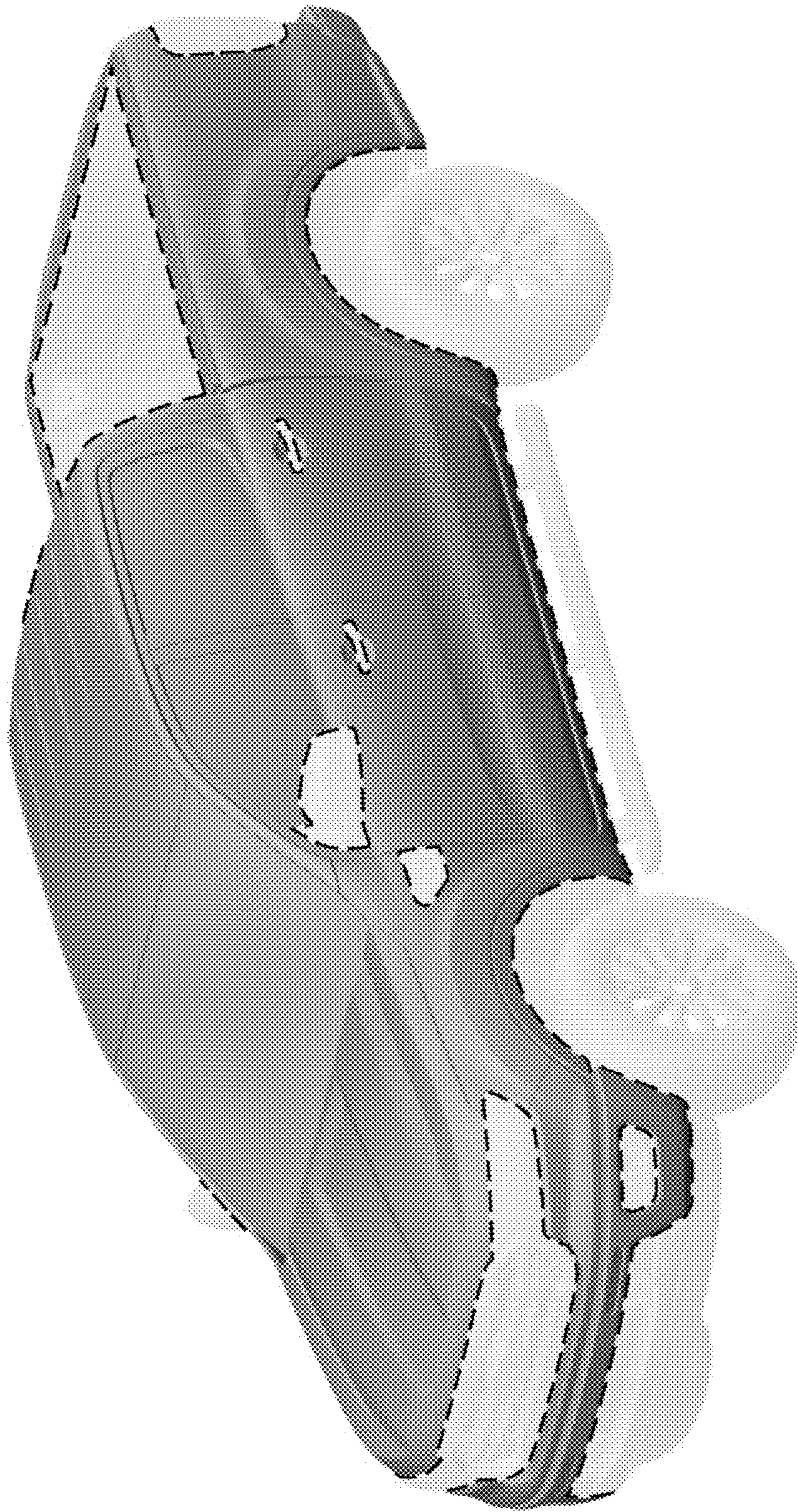

Fig. 6

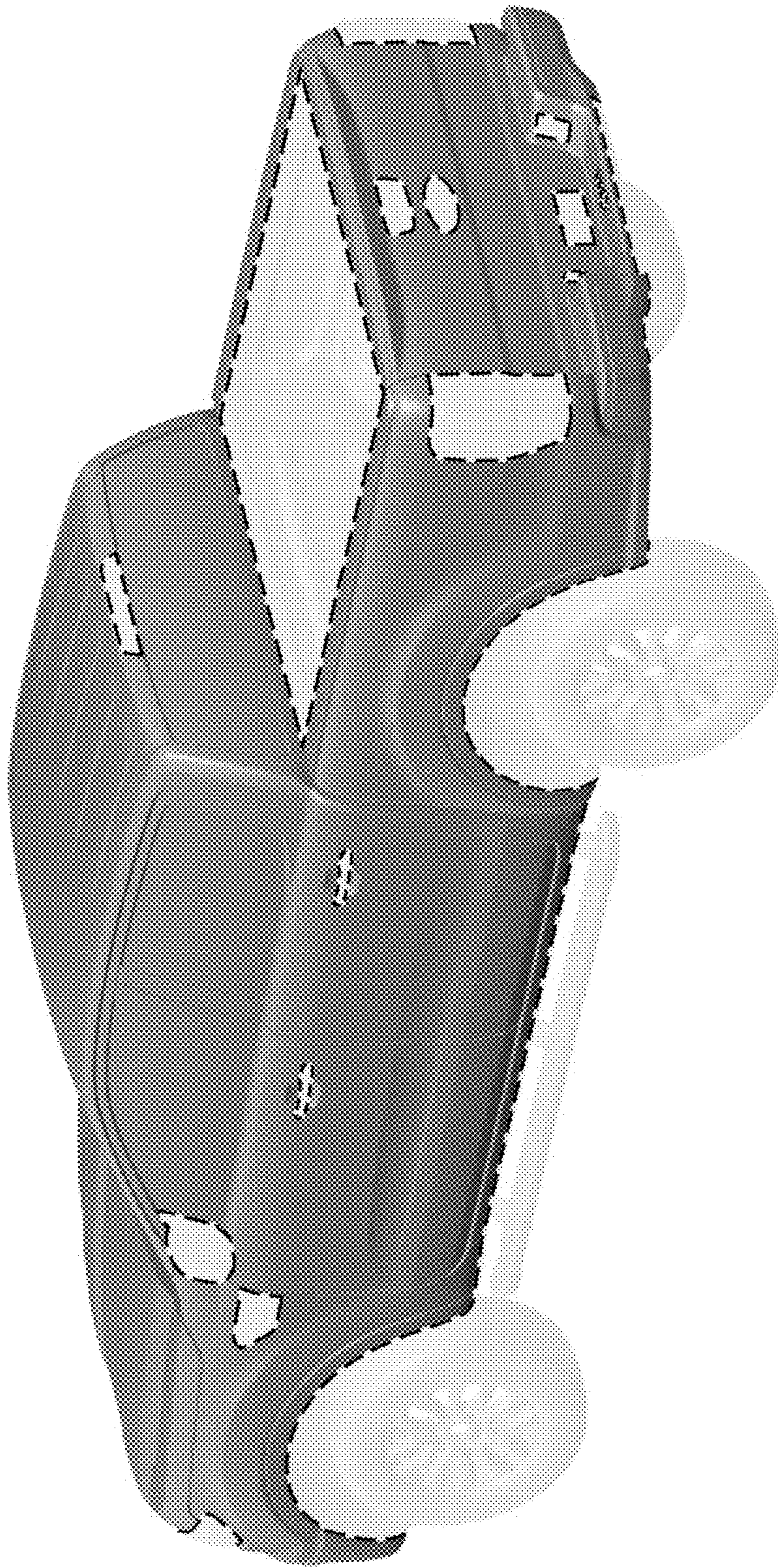

Fig. 7