

US00D869869S

(12) **United States Design Patent**
Ascalon

(10) **Patent No.:** **US D869,869 S**

(45) **Date of Patent:** **** Dec. 17, 2019**

(54) **MODULAR FURNITURE COMPONENT**

(71) Applicant: **TIMES SQUARE DISTRICT
MANAGEMENT ASSOCIATION,
INC.**, New York, NY (US)

(72) Inventor: **Brad Ascalon**, New York, NY (US)

(73) Assignee: **Times Square District Management
Association, Inc.**, New York, NY (US)

(**) Term: **15 Years**

(21) Appl. No.: **29/647,090**

(22) Filed: **May 9, 2018**

(51) **LOC (12) Cl.** **06-01**

(52) **U.S. Cl.**
USPC **D6/349; D11/155**

(58) **Field of Classification Search**
USPC D6/334-338, 340-343, 349-353, 355,
D6/364-366, 596, 601, 604, 691-691.9,
(Continued)

(56) **References Cited**

U.S. PATENT DOCUMENTS

D171,199 S * 12/1953 Edwards D19/75
D236,400 S * 8/1975 Waitzman D6/691
(Continued)

OTHER PUBLICATIONS

Times Square Design Lab Times Square NYC. [online] Published
Nov. 20, 2018. Retrieved May 6, 2019 from URL: [https://www.
timessquarenyc.org/times-square-transformation/times-square-design-
lab](https://www.timessquarenyc.org/times-square-transformation/times-square-design-lab).*

Primary Examiner — Vy N Koenig

(74) *Attorney, Agent, or Firm* — Gottlieb, Rackman &
Reisman, PC

(57) **CLAIM**

The ornamental design for a modular furniture component,
as shown and described.

DESCRIPTION

FIGS. 1-7 illustrate a design for a modular furniture component according to the invention and which further shows in broken line a generally flush top surface suitable for use as a seating surface, and wherein
FIG. 1 is a perspective view thereof;
FIG. 2 is front elevational view thereof;
FIG. 3 is a rear elevational view thereof;
FIG. 4 is a right elevational view thereof;
FIG. 5 is a left elevational view thereof;
FIG. 6 is a top plan view thereof;
FIG. 7 is a bottom plan view thereof;
FIGS. 8-14 illustrate the design for the modular furniture component according to the invention and which further shows in broken line a recessed top surface suitable for use as a receptacle for objects, and wherein
FIG. 8 is a perspective view thereof;
FIG. 9 is front elevational view thereof;
FIG. 10 is a rear elevational view thereof;
FIG. 11 is a right elevational view thereof;
FIG. 12 is a left elevational view thereof;
FIG. 13 is a top plan view thereof;
FIG. 14 is a plan view thereof; and
FIGS. 15-16 illustrate the design for the modular furniture component combined with other instances of the modular furniture component for context and configured to form exemplary seating and display assemblies, and wherein
FIG. 15 is a perspective view of a first exemplary seating and display assembly; and,
FIG. 16 is a perspective view of a second exemplary seating and display assembly.
The broken lines in the figures are for the purpose of illustrating environmental structure, specifically certain features of the modular furniture component in all figures and the individual and plants in FIGS. 15 and 16, and form no part of the claimed design.
The symbolic break lines in the figures convey that the appearance of any portion of the modular furniture component between the symbolic break lines forms no part of the claimed design.

1 Claim, 12 Drawing Sheets

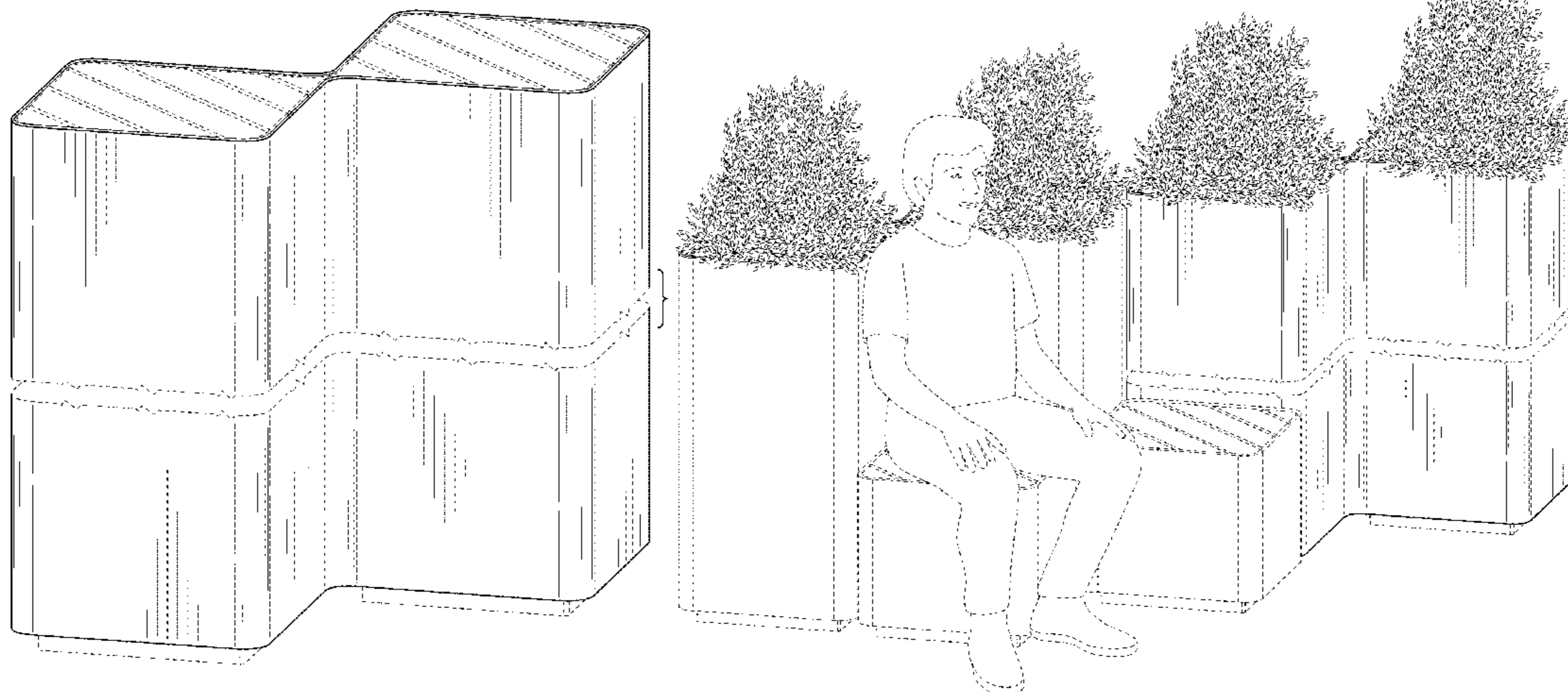

(58) **Field of Classification Search**

USPC D6/692–692.6, 716–716.1; D25/65;
D11/143, 155

CPC A47B 7/00–02; A47C 11/00; A47C 12/00;
A47C 16/02–04; A47C 9/00–105

See application file for complete search history.

(56) **References Cited**

U.S. PATENT DOCUMENTS

D245,408	S	*	8/1977	Baumann	D11/155
D261,874	S	*	11/1981	Tenzer	D11/143
D268,256	S	*	3/1983	Peterson	D11/155
D274,676	S	*	7/1984	Massonnet	D6/349
D332,681	S	*	1/1993	Waterson	D34/7
D338,140	S	*	8/1993	Scott, Jr.	D11/155
D340,169	S	*	10/1993	Scott, Jr.	D11/155
D525,166	S	*	7/2006	Cordeiro	D11/143
D622,959	S	*	9/2010	Zalewski	D3/273
D684,215	S	*	6/2013	Markowitz	D21/333
D693,155	S	*	11/2013	Wu	D6/672
D693,612	S	*	11/2013	Arko	D6/708
D735,500	S	*	8/2015	Wu	D6/675
D742,134	S	*	11/2015	Miller	D6/381
D761,153	S	*	7/2016	Agar	D11/143
D782,229	S	*	3/2017	Merritt	D6/691
D805,311	S	*	12/2017	Mandon	D6/349

* cited by examiner

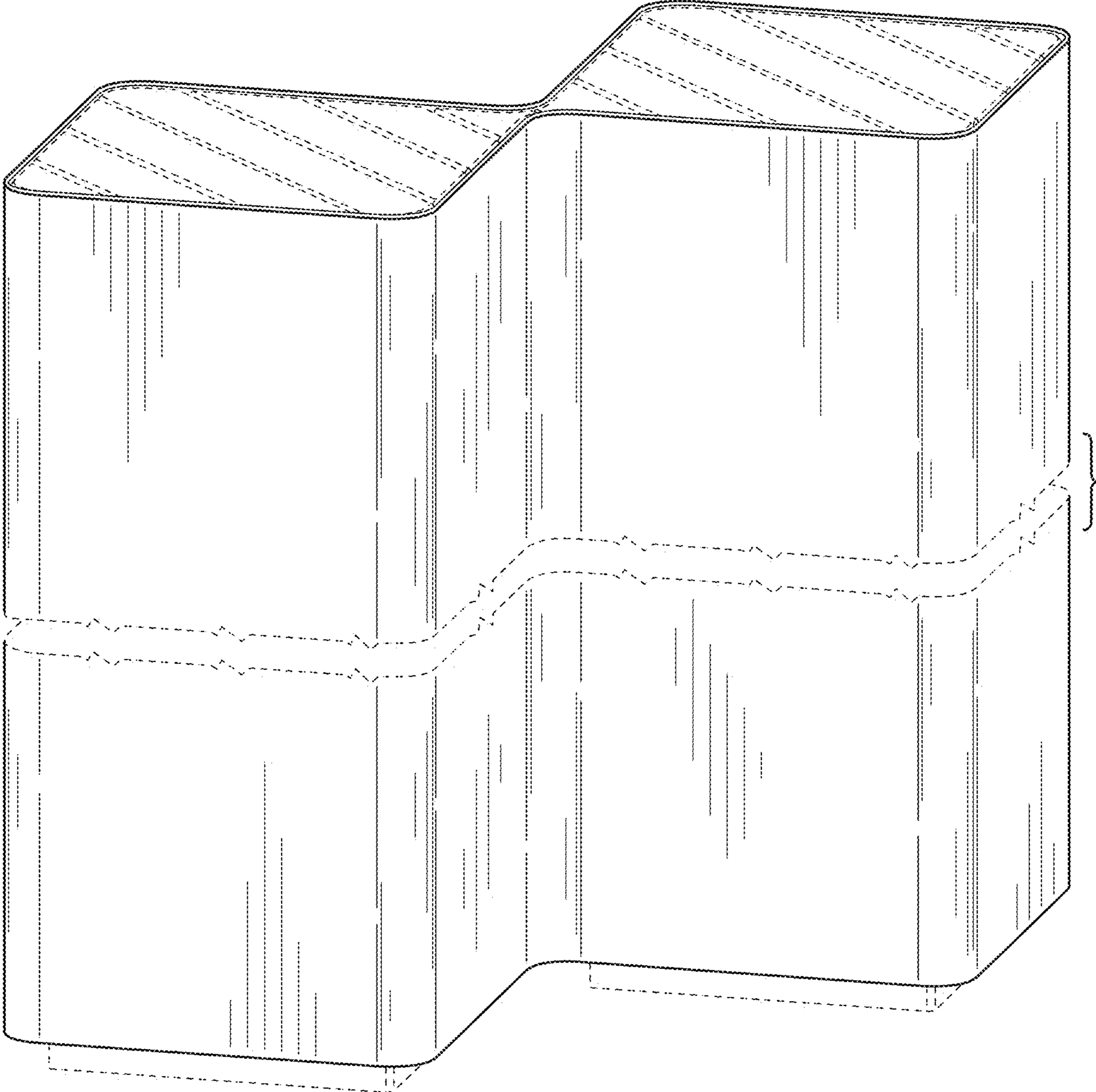

FIG. 1

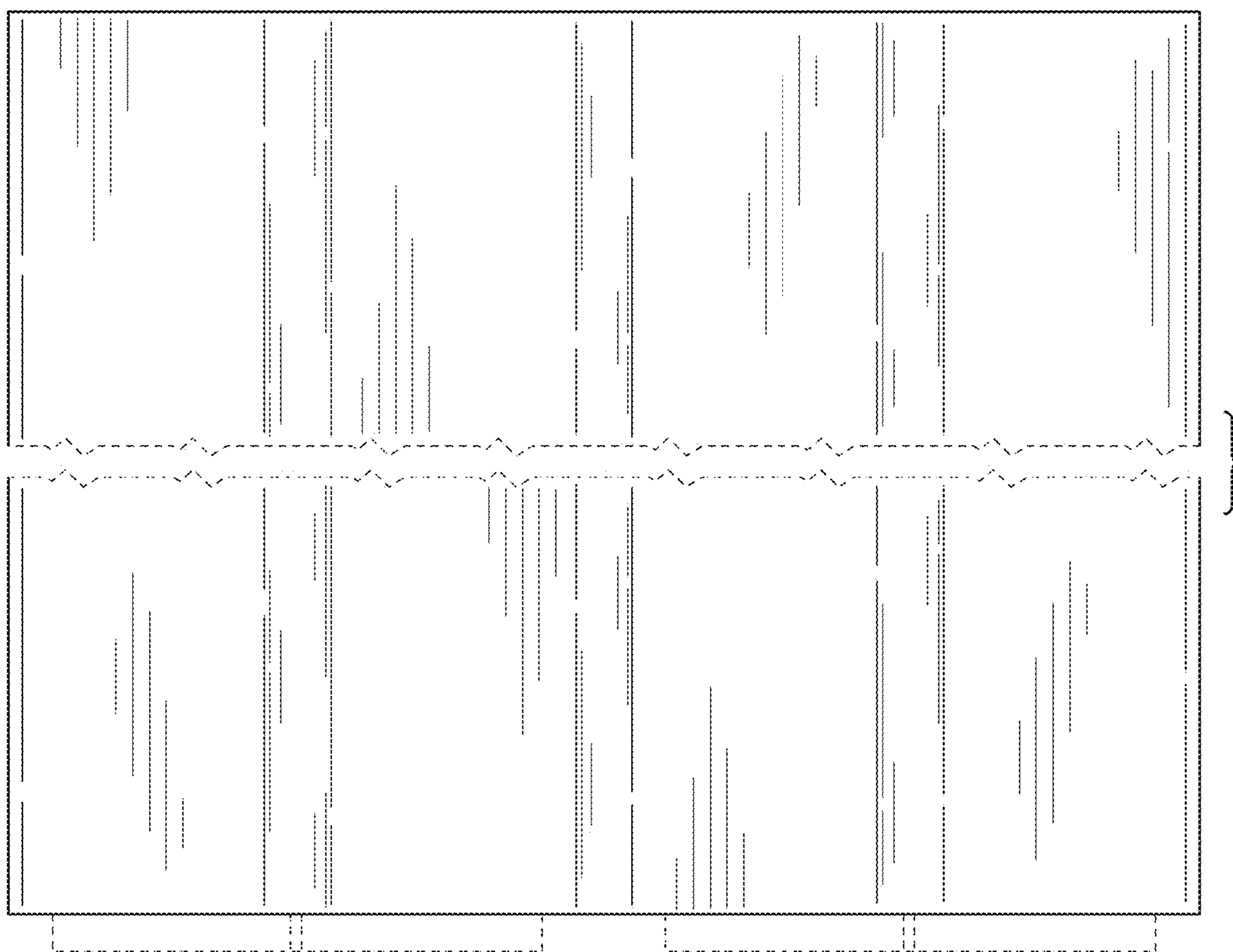

FIG. 2

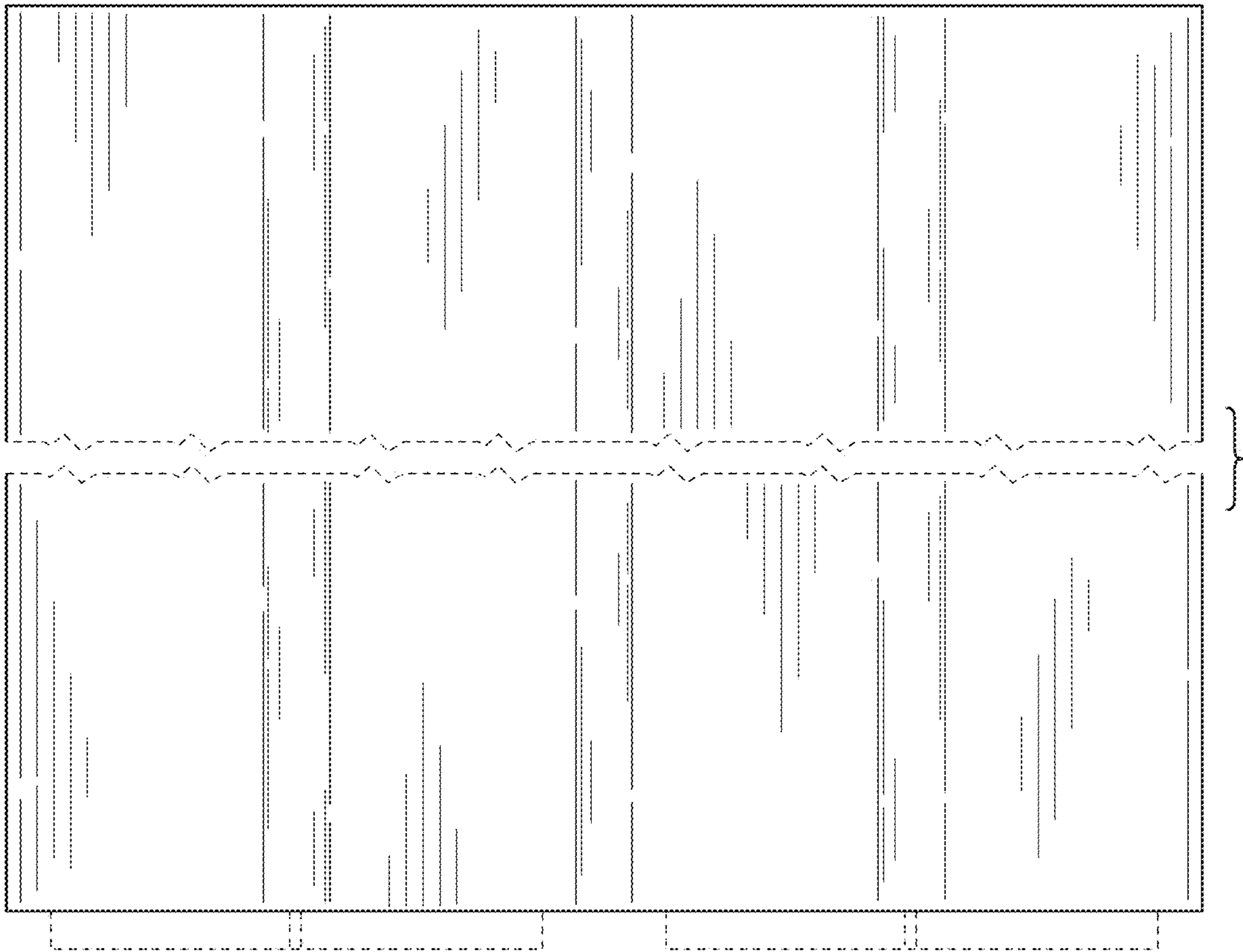

FIG. 3

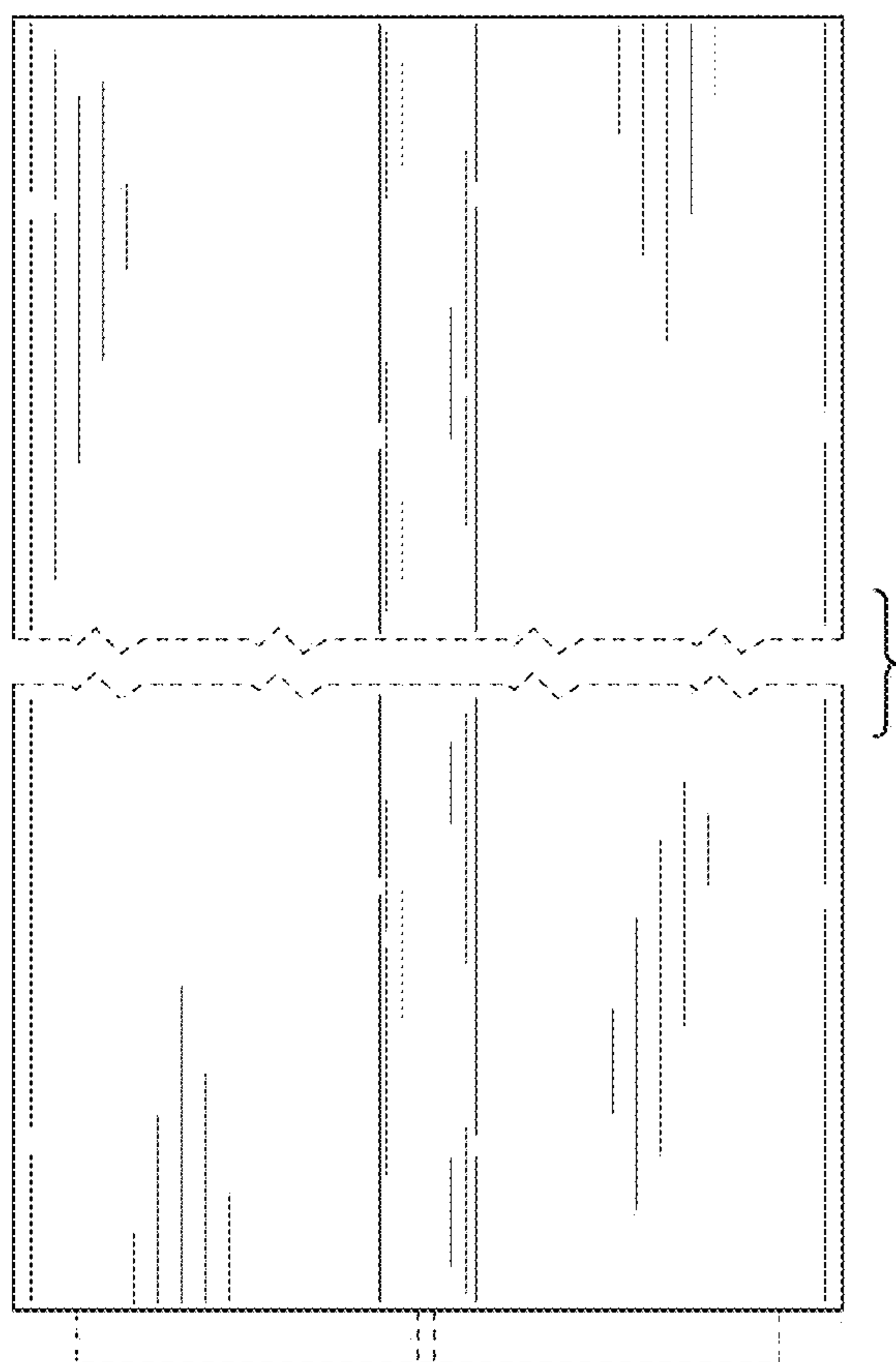

FIG. 4

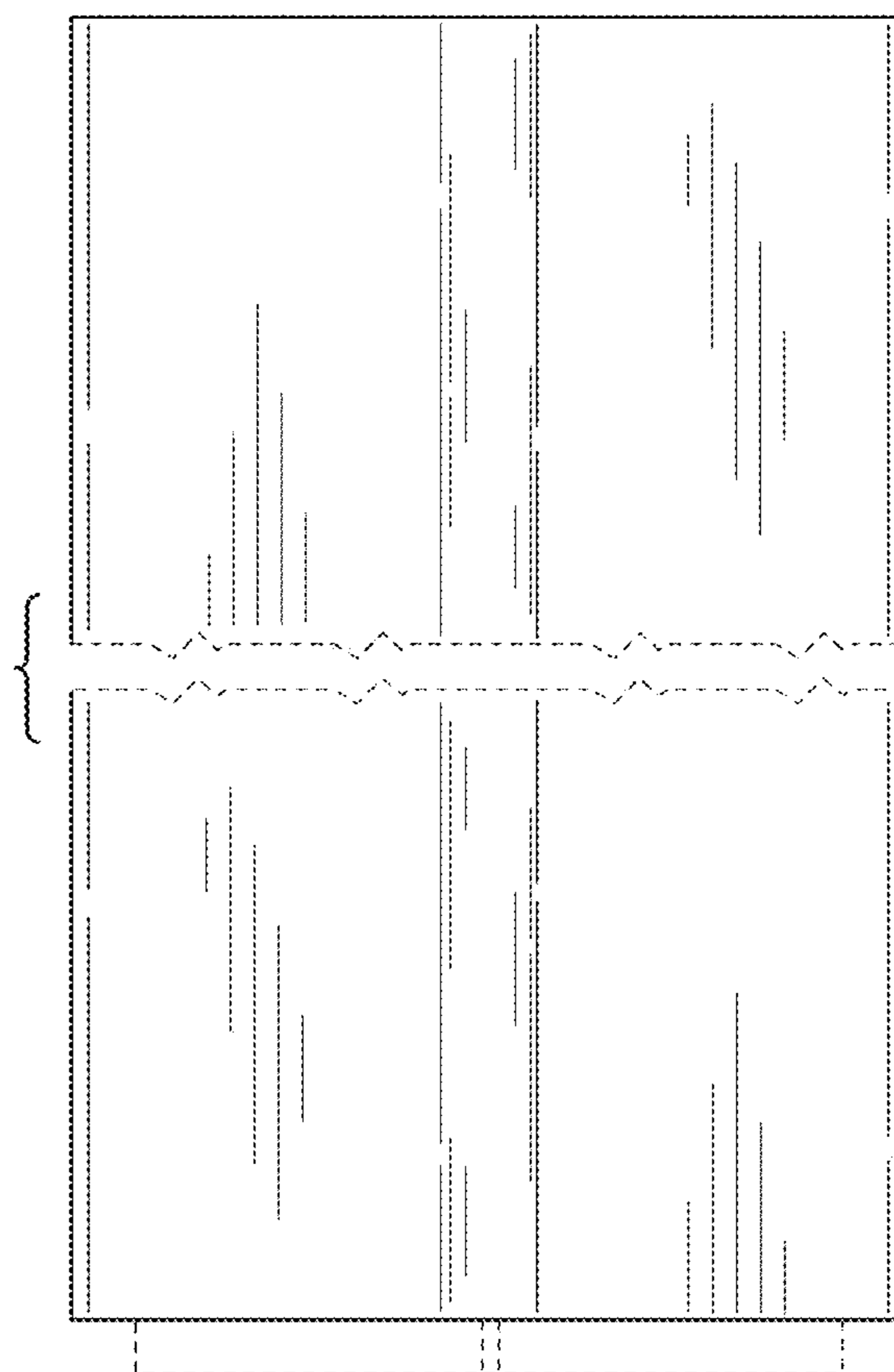

FIG. 5

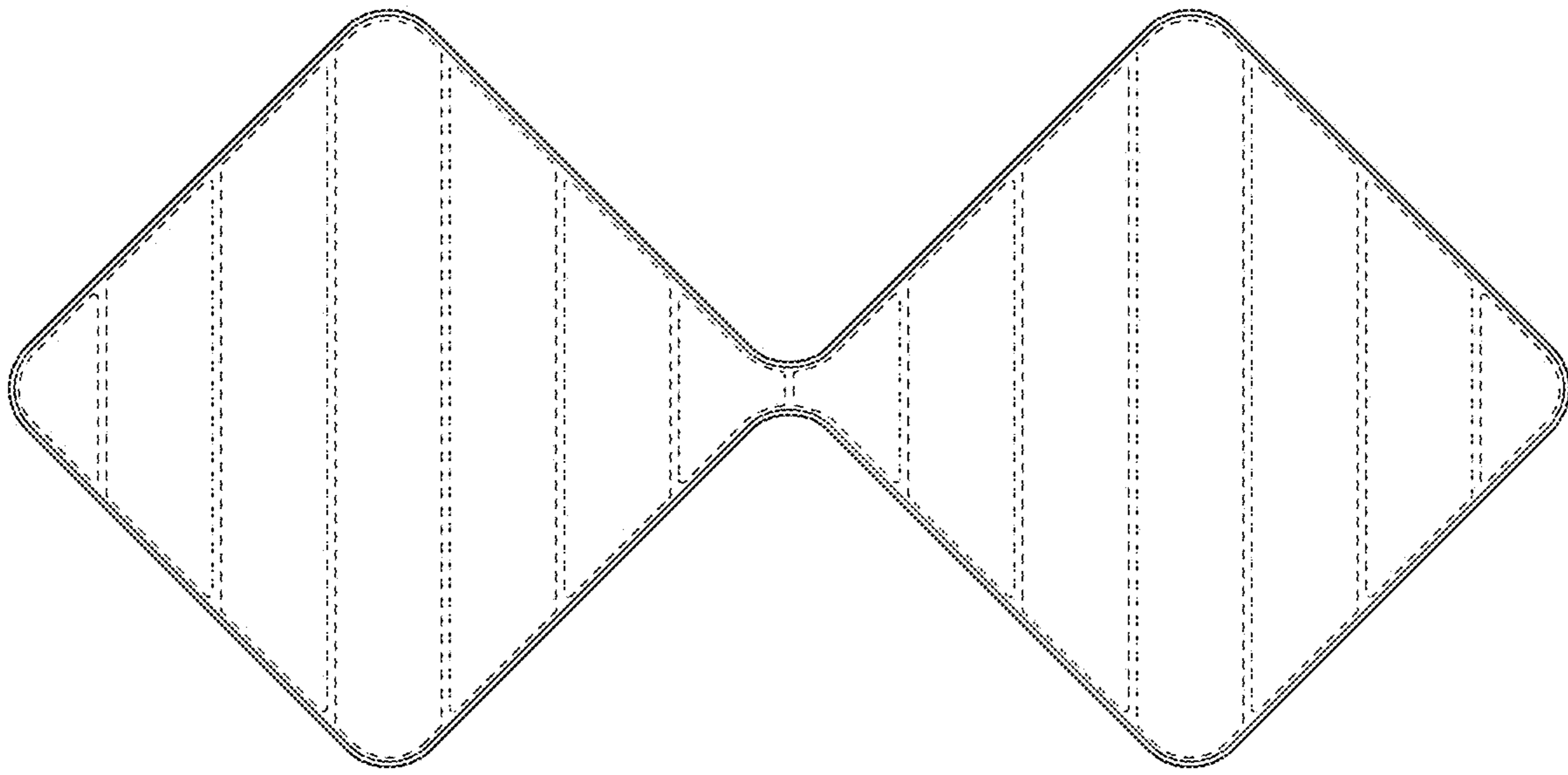

FIG. 6

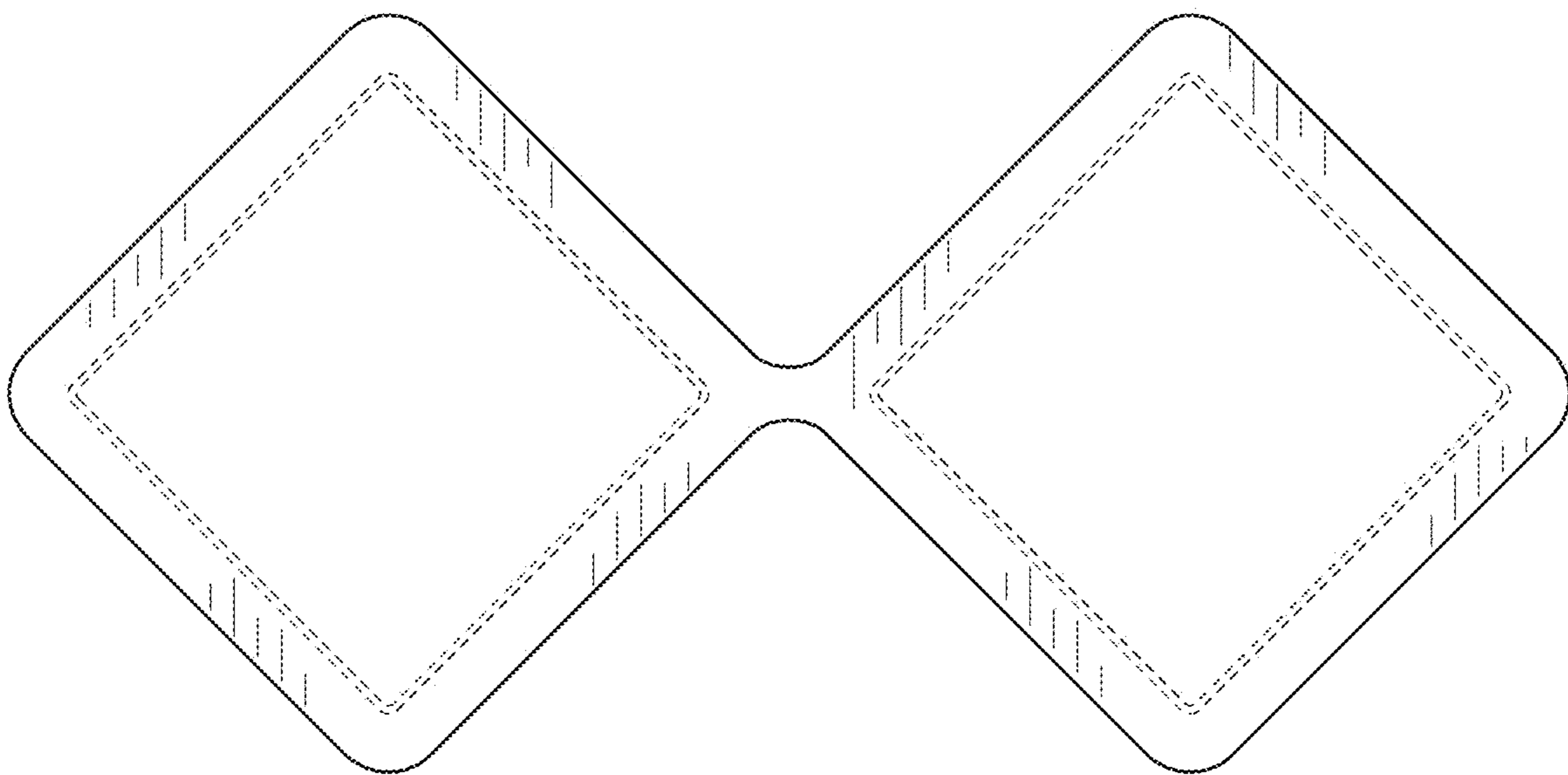

FIG. 7

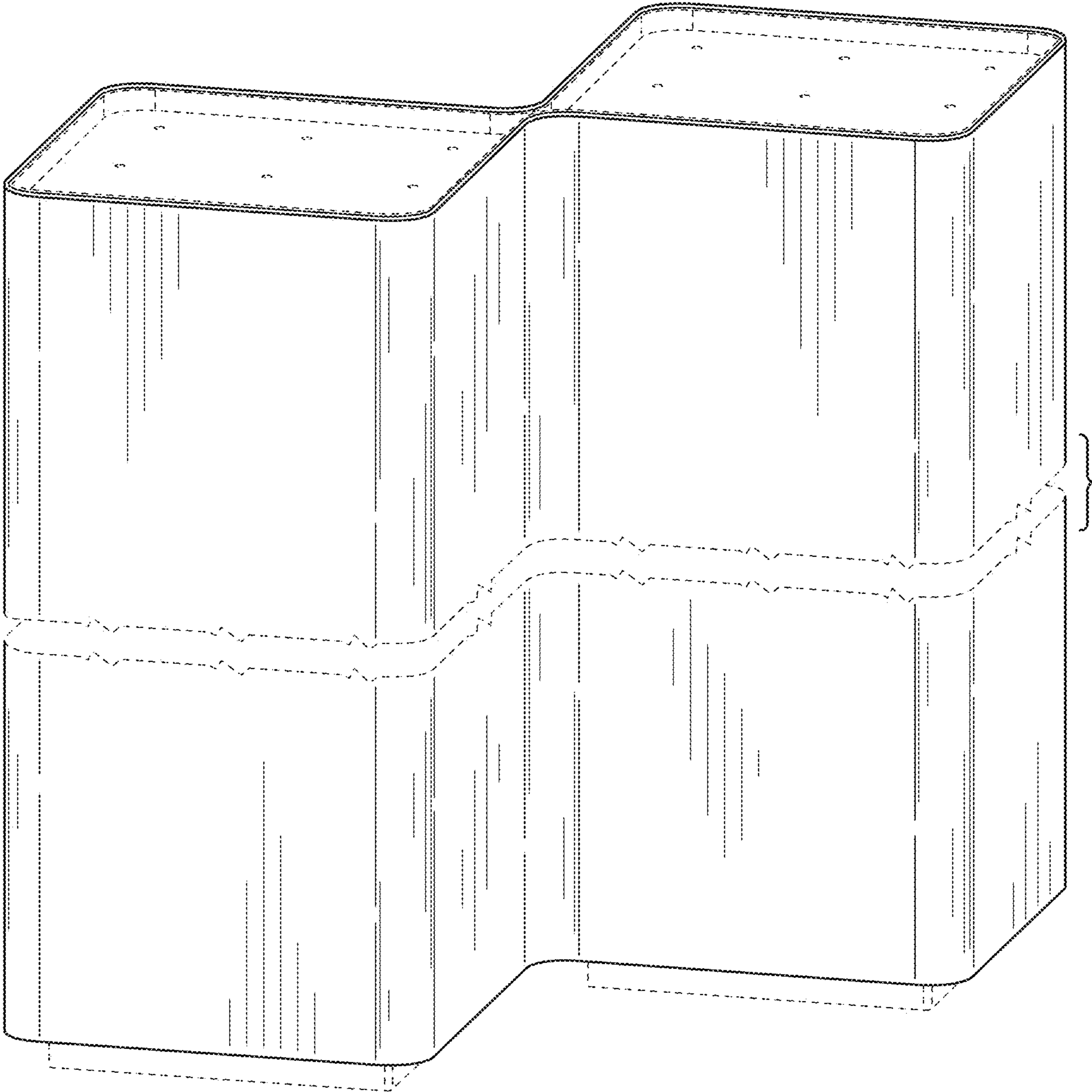

FIG. 8

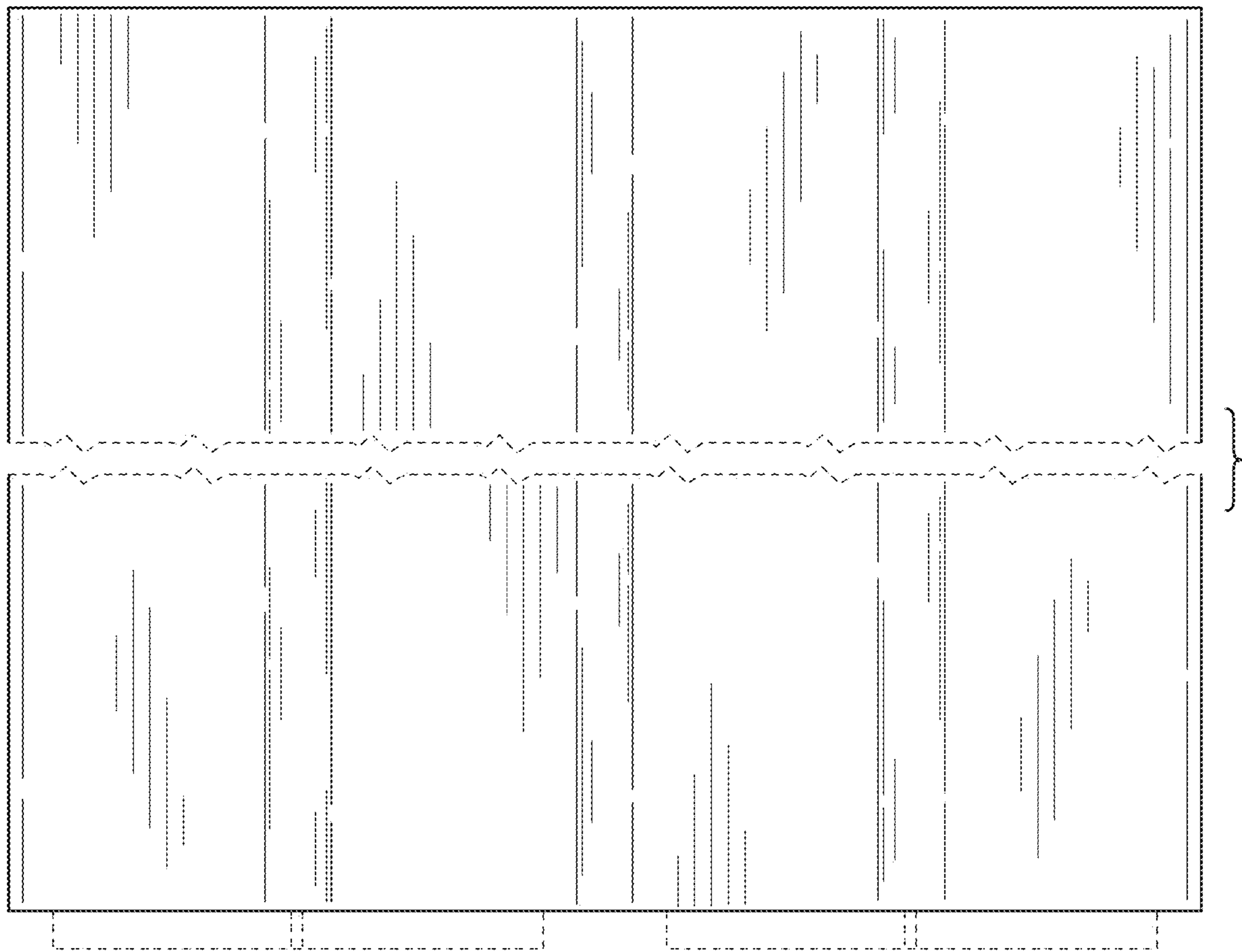

FIG. 9

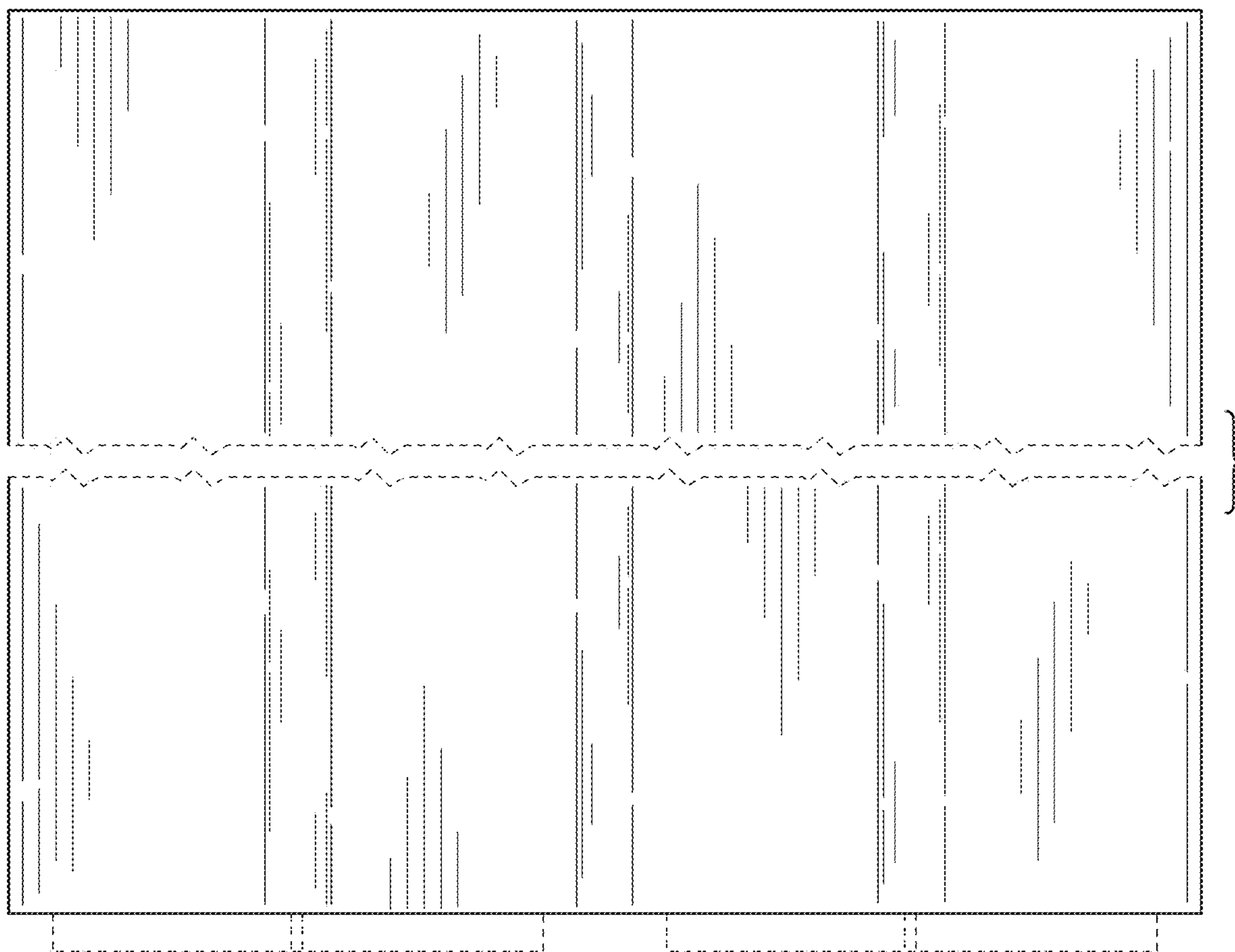

FIG. 10

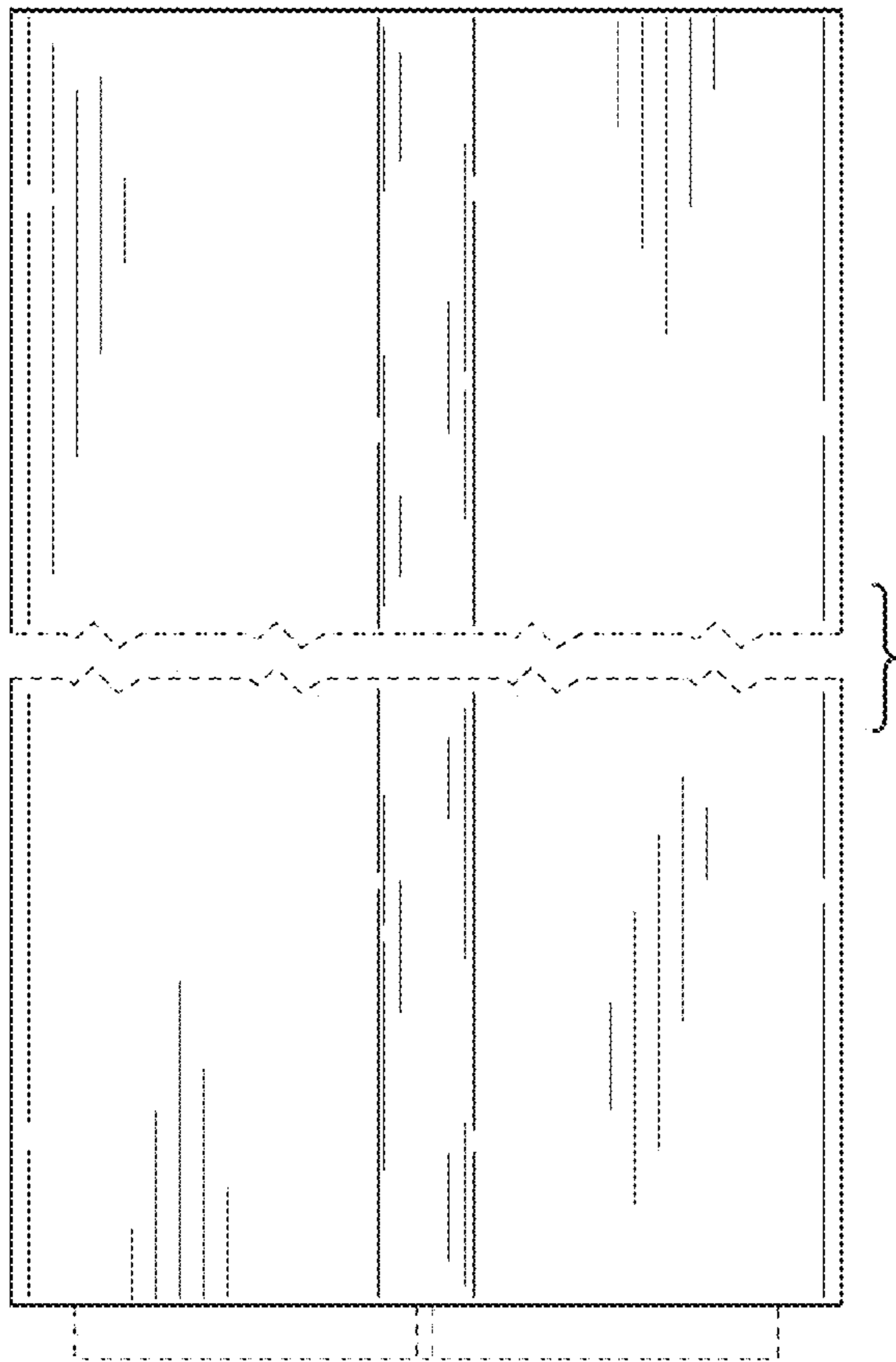

FIG. 11

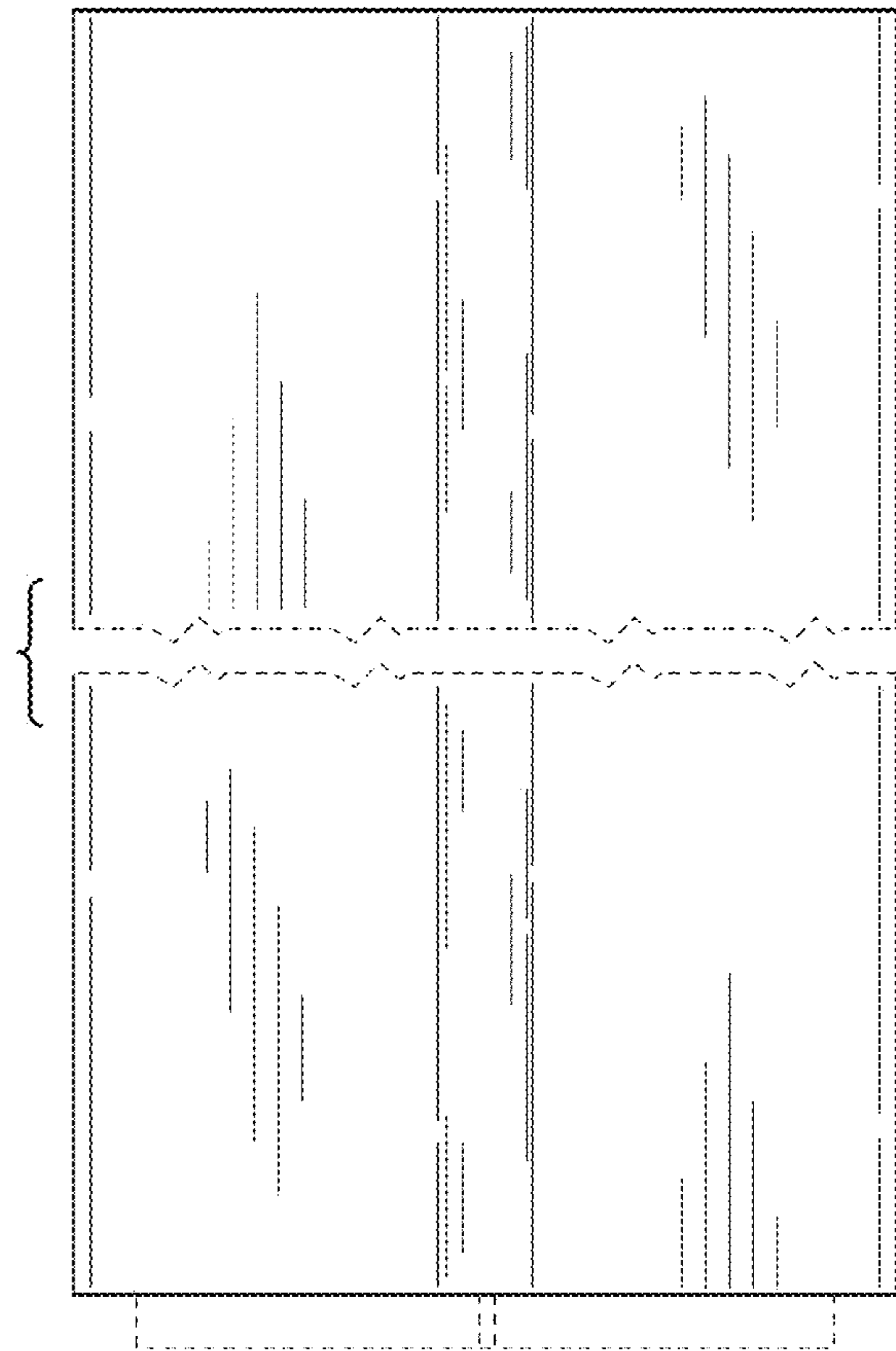

FIG. 12

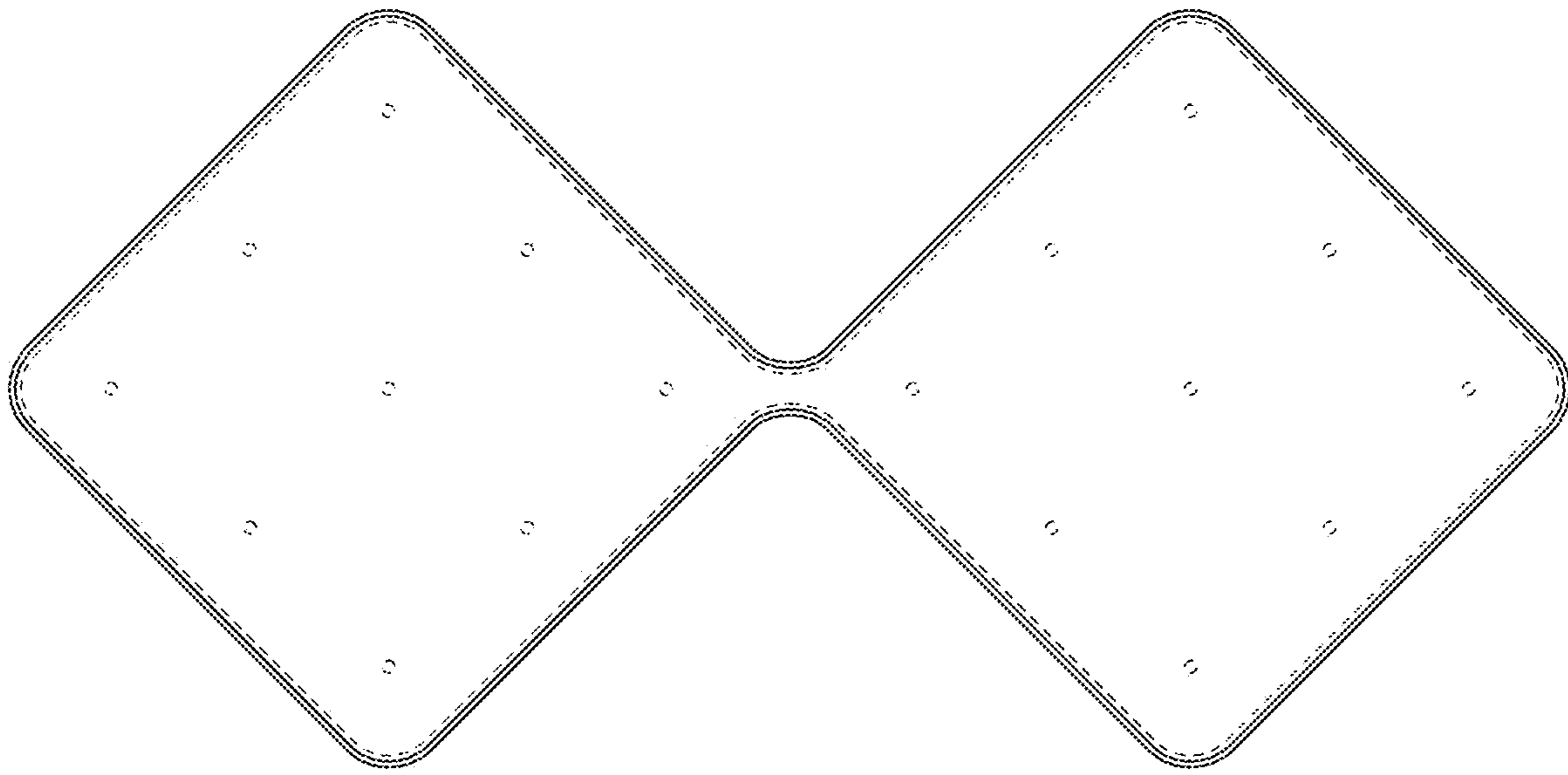

FIG. 13

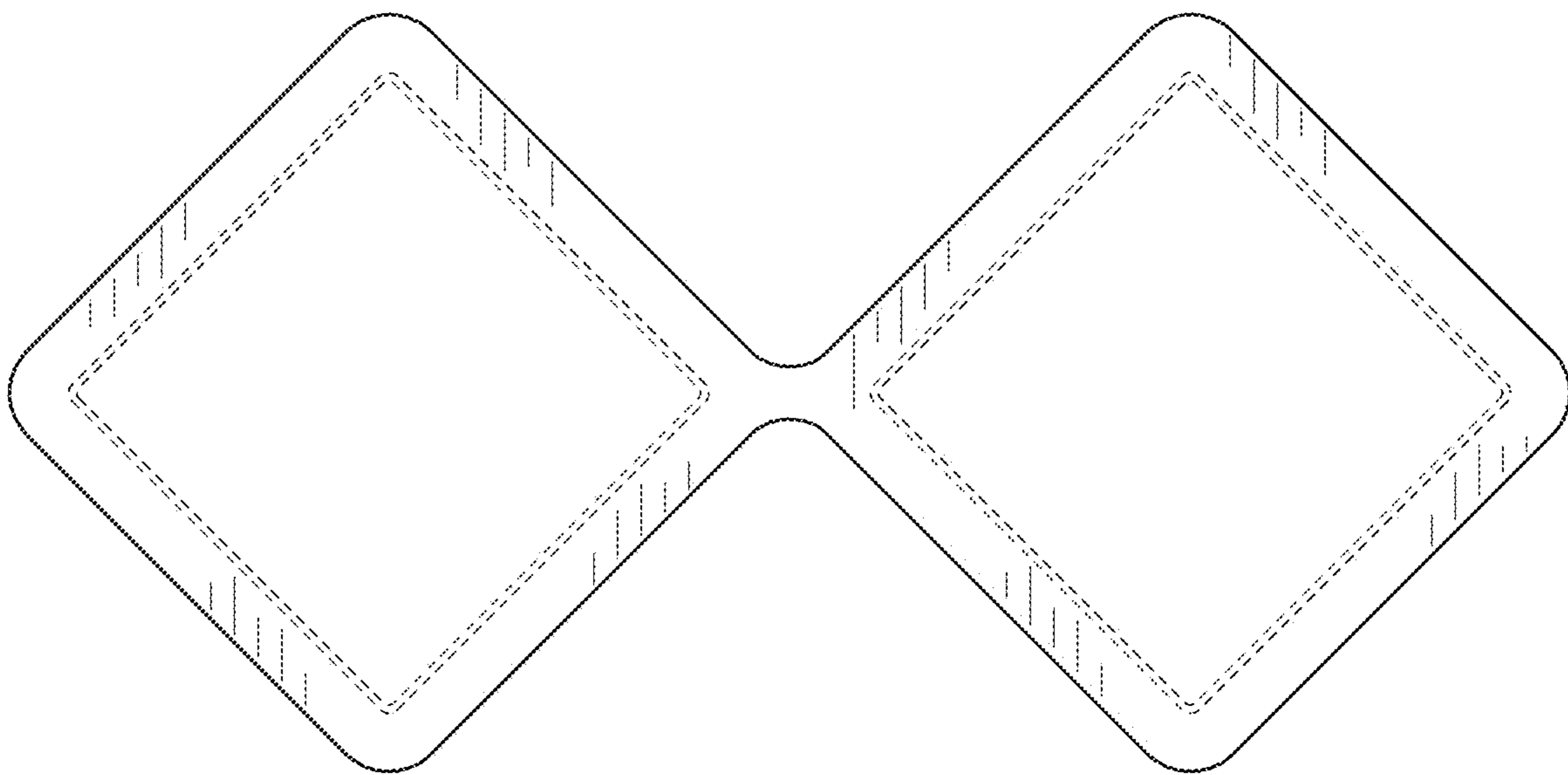

FIG. 14

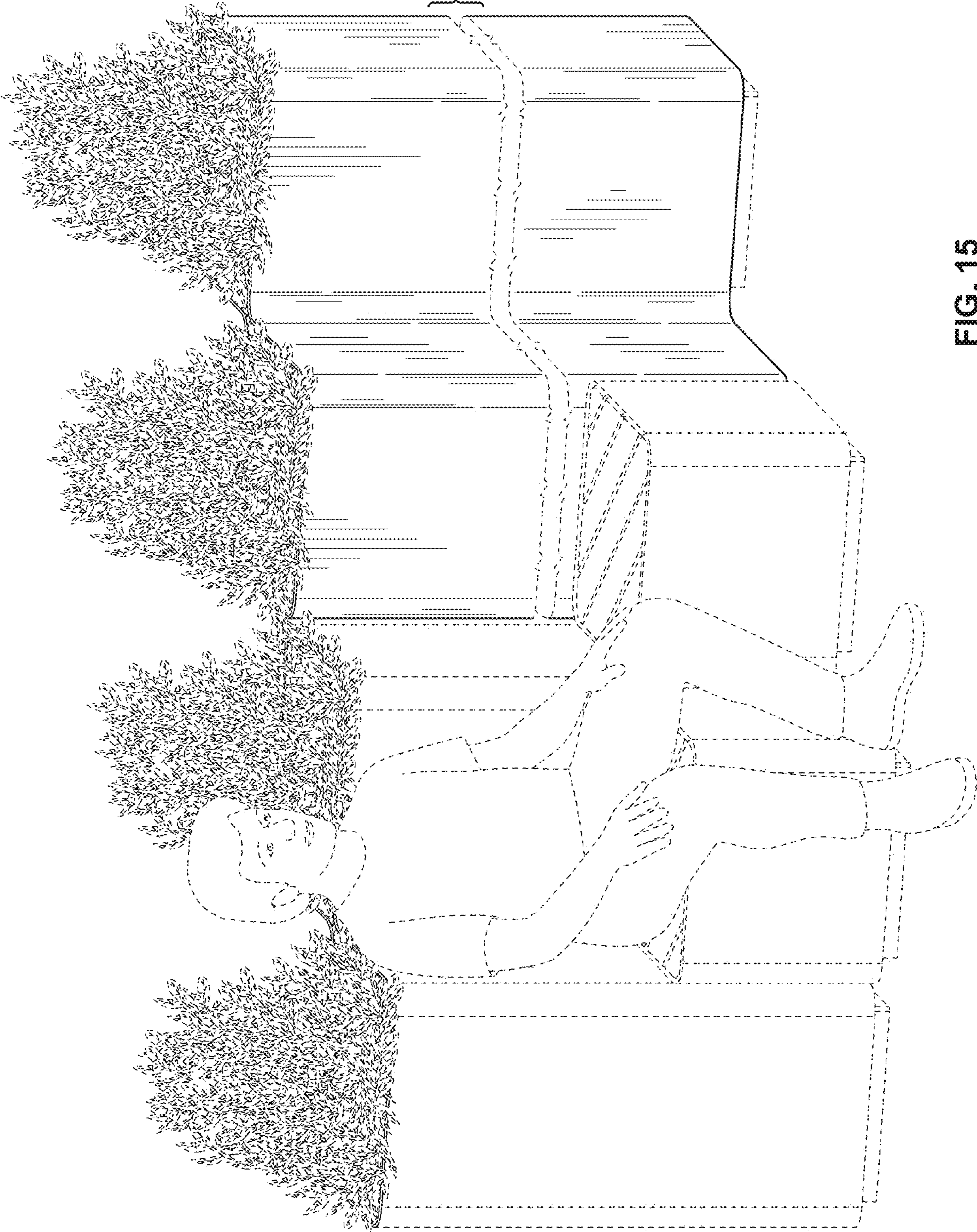

FIG. 15

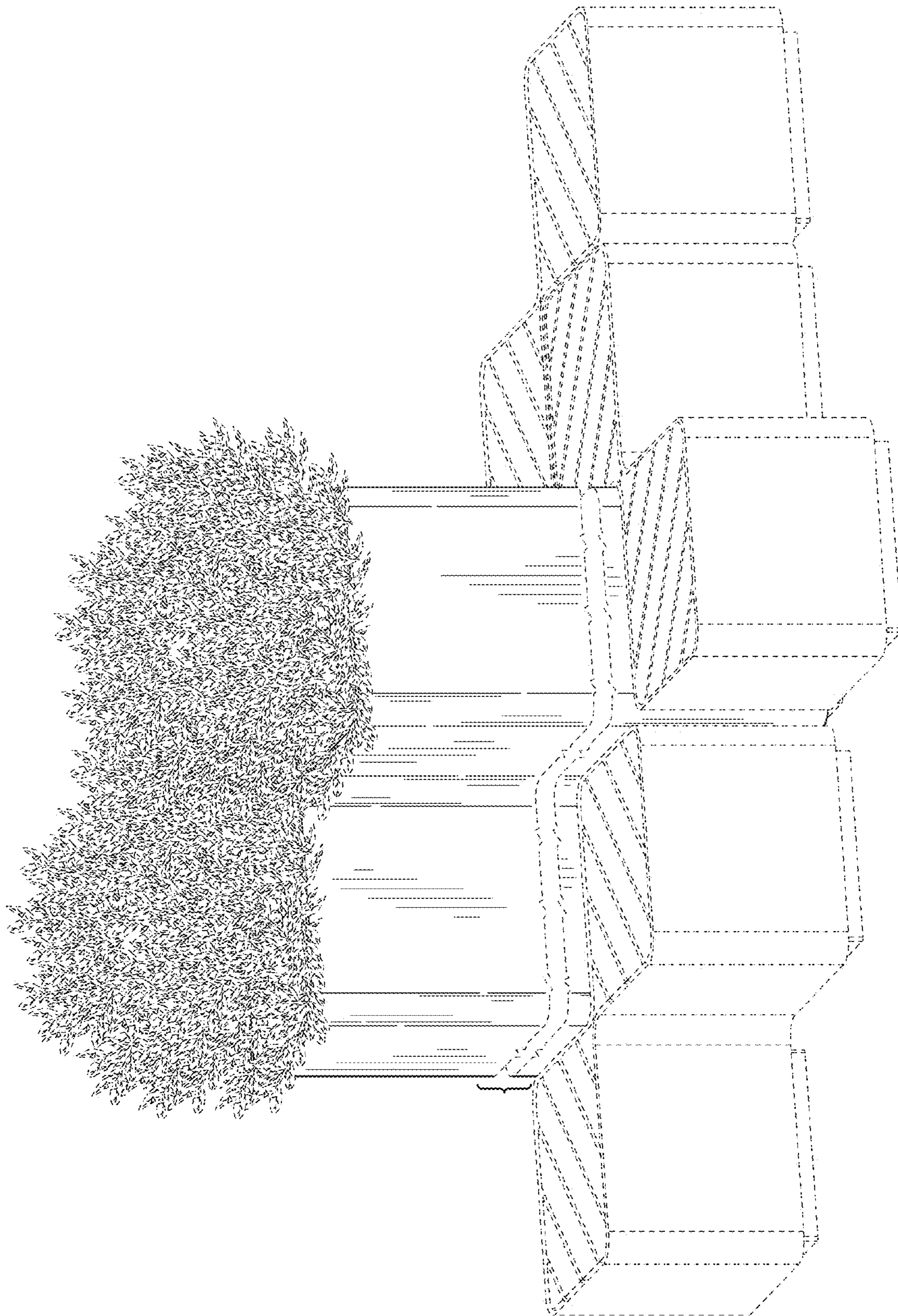

FIG. 16