



US00D869547S

(12) **United States Design Patent** (10) **Patent No.:** **US D869,547 S**
Xin (45) **Date of Patent:** **** Dec. 10, 2019**

(54) **SKI GLASSES**

(71) Applicant: **Yi Xin**, Hunan (CN)

(72) Inventor: **Yi Xin**, Hunan (CN)

(**) Term: **15 Years**

(21) Appl. No.: **29/611,395**

(22) Filed: **Jul. 20, 2017**

(51) **LOC (12) Cl.** **16-06**

(52) **U.S. Cl.**

USPC **D16/312**

(58) **Field of Classification Search**

USPC D16/101, 300-342, 900; D29/109-110;
351/41, 44, 45-48, 51-52, 62, 158, 92,
351/103-123, 140-153, 63, 59; 2/13, 15,
2/426-432, 447-449, 441, 434-437
CPC G02C 2200/08; G02C 1/06; G02C 5/14;
G02C 11/02; G02C 11/04; G02C 5/16;
G02C 2200/22; G02C 5/146; G02C
5/2254; G02C 5/008; G01C 5/16; A61M
2021/0044; A63B 33/002

See application file for complete search history.

(56) **References Cited**

U.S. PATENT DOCUMENTS

3,517,393 A * 6/1970 Beauchef G02C 11/08
2/436
D327,490 S * 6/1992 Wilson D16/312
D405,102 S * 2/1999 Moritz D16/312
6,047,410 A * 4/2000 Dondero A61F 9/027
2/426
D427,225 S * 6/2000 Arnette D16/312
D428,039 S * 7/2000 Thixton D16/312
6,098,204 A * 8/2000 Arnette A61F 9/02
2/202
D477,010 S * 7/2003 Moritz D16/312
D484,524 S * 12/2003 Wiedner D16/312
D488,182 S * 4/2004 Sheldon D16/312
D503,422 S * 3/2005 Canavan D16/101

D505,444 S * 5/2005 Borlet D16/312
D508,939 S * 8/2005 Hussey D16/312
D509,236 S * 9/2005 Sheldon D16/306
D519,147 S * 4/2006 Moritz D16/312
D524,352 S * 7/2006 Hsu D16/312
D527,757 S * 9/2006 Chen D16/312
D537,099 S * 2/2007 Saderholm D16/312
D537,100 S * 2/2007 Moritz D16/312
D542,327 S * 5/2007 Hsu D16/312
D542,829 S * 5/2007 Hsu D16/312
D542,830 S * 5/2007 Hsu D16/312
D544,900 S * 6/2007 Li D16/312

(Continued)

FOREIGN PATENT DOCUMENTS

KR 300822231 * 10/2015

Primary Examiner — Michelle E. Wilson

Assistant Examiner — Sanjeev Paul

(74) *Attorney, Agent, or Firm* — ScienBiziP, P.C.

(57) **CLAIM**

The ornamental design for a ski glasses, as shown and described.

DESCRIPTION

FIG. 1 is a first perspective view of a ski glasses showing my new design;

FIG. 2 is a second perspective view thereof;

FIG. 3 is a front elevational view thereof;

FIG. 4 is a rear elevational view thereof;

FIG. 5 is a left side view thereof;

FIG. 6 is a right side view thereof;

FIG. 7 is a top plan view thereof;

FIG. 8 is a bottom plan view thereof; and,

FIG. 9 is a perspective view showing the ski glasses in a use state.

The broken lines in FIG. 9 depict a belt and a head which form no part of the claimed design.

The diagonal lines indicate transparency.

1 Claim, 9 Drawing Sheets

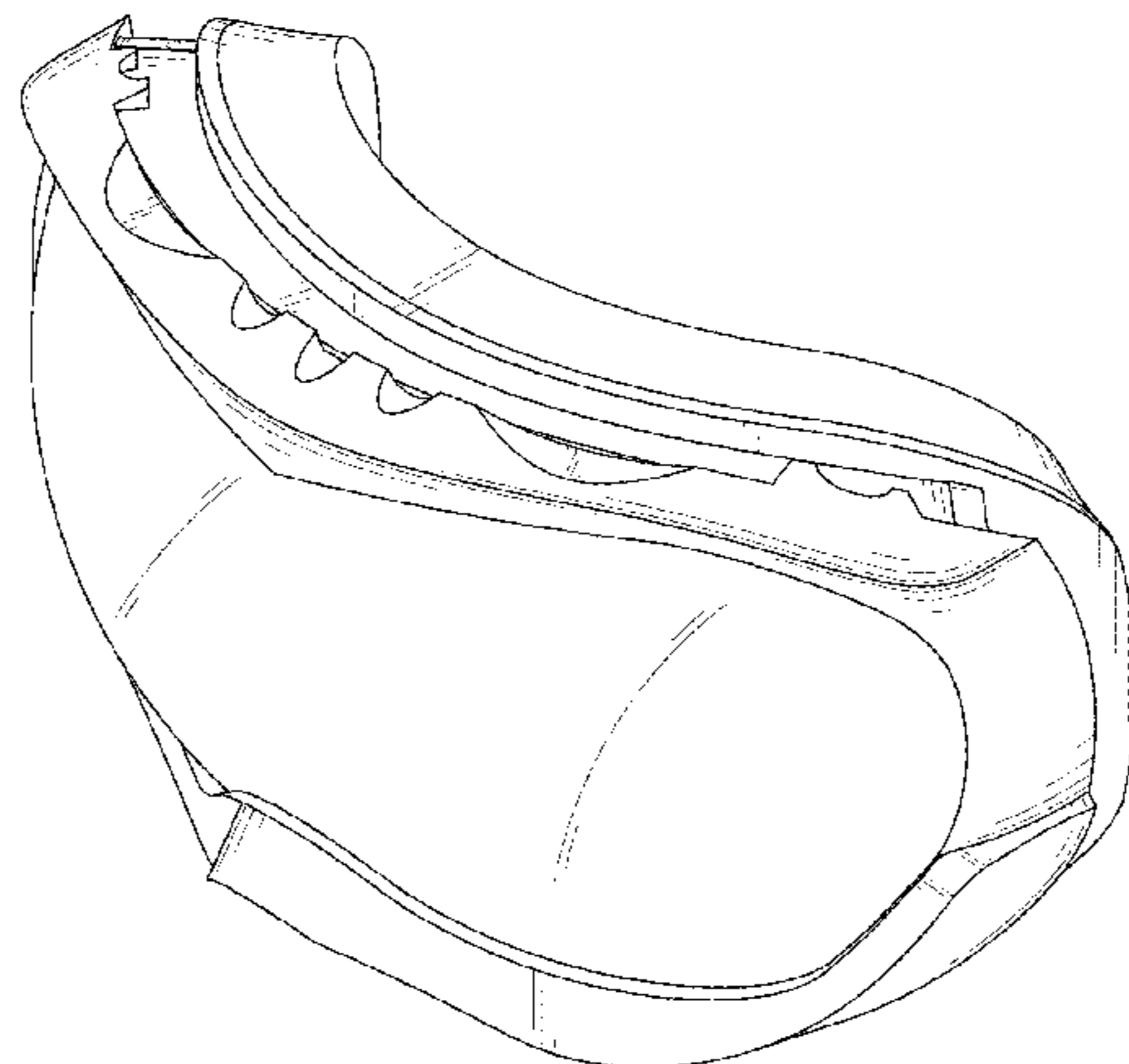

(56)

References Cited

U.S. PATENT DOCUMENTS

D547,354 S *	7/2007	Fuchs	D16/312
D549,267 S *	8/2007	Chen	D16/312
D551,278 S *	9/2007	Moritz	D16/312
D551,280 S *	9/2007	Li	D16/312
D552,662 S *	10/2007	Woxing	D16/312
D556,238 S *	11/2007	Yang	D16/312
D556,811 S *	12/2007	Bruck	D16/312
D556,812 S *	12/2007	Wang-Lee	D16/312
D559,299 S *	1/2008	Tabacchi	D16/303
7,322,051 B1 *	1/2008	Wang	A61F 9/027 2/448
D569,411 S *	5/2008	Chiang	D16/311
D574,409 S *	8/2008	Stanley	D16/312
D577,054 S *	9/2008	Moritz	D16/312
D578,562 S *	10/2008	Moritz	D16/312
D581,964 S *	12/2008	Hooper	D16/311
D588,624 S *	3/2009	Yang	D16/311
D592,694 S *	5/2009	Fuchs	D16/312
D595,332 S *	6/2009	Yang	D16/312
D598,040 S *	8/2009	Sheldon	D16/312
D608,816 S *	1/2010	Wang-Lee	D16/312
D609,265 S *	2/2010	Wang-Lee	D16/312
D610,602 S *	2/2010	Yun	D16/312
D616,483 S *	5/2010	Moritz	D16/312
D616,914 S *	6/2010	Moritz	D16/312
D620,969 S *	8/2010	Cyr	D16/312
D626,166 S *	10/2010	Yang	D16/312
D626,582 S *	11/2010	Cheng	D16/326
D629,034 S *	12/2010	McNeal	A61F 9/025 D16/312
D629,035 S *	12/2010	Moritz	D16/312
D629,442 S *	12/2010	Tominaga	D16/312
D633,937 S *	3/2011	Yasuhara	D16/312
D640,724 S *	6/2011	Goodman	D16/312
D649,178 S *	11/2011	Moritz	D16/312
D649,577 S *	11/2011	Goodman	D16/312
D653,686 S *	2/2012	Tobia	D16/101
D653,695 S *	2/2012	Tobia	D16/312
D657,812 S *	4/2012	Li	D16/312
D659,742 S *	5/2012	Chen	D16/312
D669,113 S *	10/2012	Sandor	D16/309
D670,753 S *	11/2012	Chen	D16/312
D675,244 S *	1/2013	Orzeck	D16/312
8,371,691 B2 *	2/2013	Chiou	G02C 9/00 351/47
D678,932 S *	3/2013	Moritz	D16/312
D687,479 S *	8/2013	Moritz	D16/312
D687,480 S *	8/2013	Castro	D16/312
D687,881 S *	8/2013	Ginther	D16/312
D694,806 S *	12/2013	Mage	D16/312
D695,335 S *	12/2013	Goodman	D16/312
D695,818 S *	12/2013	Laperriere	D16/312
D698,854 S *	2/2014	McNeal	D16/312
D700,929 S *	3/2014	McNeal	D16/312
D711,961 S *	8/2014	Arnette	D16/312
D714,378 S *	9/2014	Sandor	D16/313
D715,350 S *	10/2014	Moritz	D16/312
D717,851 S *	11/2014	Arnette	D16/101
D718,369 S *	11/2014	Janavicius	D16/312
D723,094 S *	2/2015	Chen	D16/312
D725,175 S *	3/2015	Wang-Lee	D16/312
D726,378 S *	4/2015	Wako	D29/110
D727,398 S *	4/2015	Blanchard	D16/312
D727,400 S *	4/2015	Blanchard	D16/314
D729,303 S *	5/2015	Laperriere	D16/326
D747,758 S *	1/2016	Lee	D16/312
D757,833 S *	5/2016	Pfanner	D16/101
D761,344 S *	7/2016	Chen	D16/312
D784,441 S *	4/2017	Garfias	D16/312
D785,699 S *	5/2017	Chen	D16/312
D802,651 S *	11/2017	Thixton	D16/330
D828,866 S *	9/2018	Yoo	D16/313
D829,810 S *	10/2018	Nellestam	D16/313
D830,448 S *	10/2018	Hardi	D16/301
D834,087 S *	11/2018	Yoo	D16/313
D834,755 S *	11/2018	Schempp	D29/110
D847,248 S *	4/2019	Liang	D16/313
2003/0110552 A1 *	6/2003	Youmans	A61F 9/028 2/426
2003/0233702 A1 *	12/2003	Chen	A61F 9/027 2/428
2007/0169252 A1 *	7/2007	Rayl	A61F 9/025 2/435
2008/0301857 A1 *	12/2008	Wang-Lee	A61F 9/025 2/431
2008/0316421 A1 *	12/2008	Wang	A61F 9/025 351/62
2009/0100577 A1 *	4/2009	Kobayashi	A61F 9/02 2/436
2011/0296596 A1 *	12/2011	Chen	A61F 9/028 2/436
2012/0236250 A1 *	9/2012	Yang	G02C 7/02 351/62
2013/0185849 A1 *	7/2013	Laughlin	A61F 9/025 2/431
2014/0033408 A1 *	2/2014	Currens	A61F 9/025 2/431
2015/0202087 A1 *	7/2015	Chen	A61F 9/026 2/431
2015/0290036 A1 *	10/2015	Wang-Lee	A61F 9/026 2/428
2015/0297410 A1 *	10/2015	Park	A61F 9/028 2/436
2015/0320600 A1 *	11/2015	Blanchard	A61F 9/025 2/431

* cited by examiner

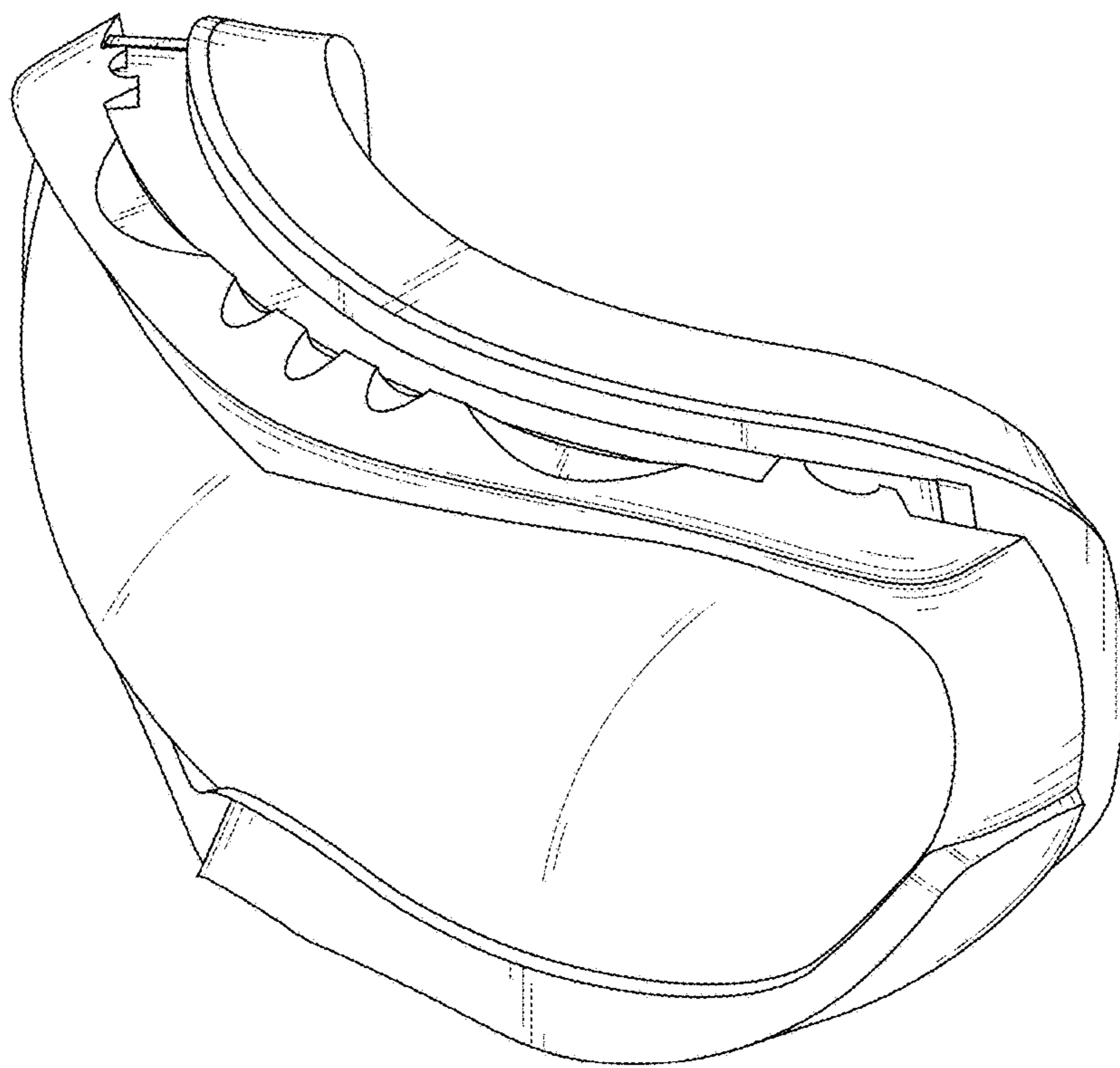

FIG. 1

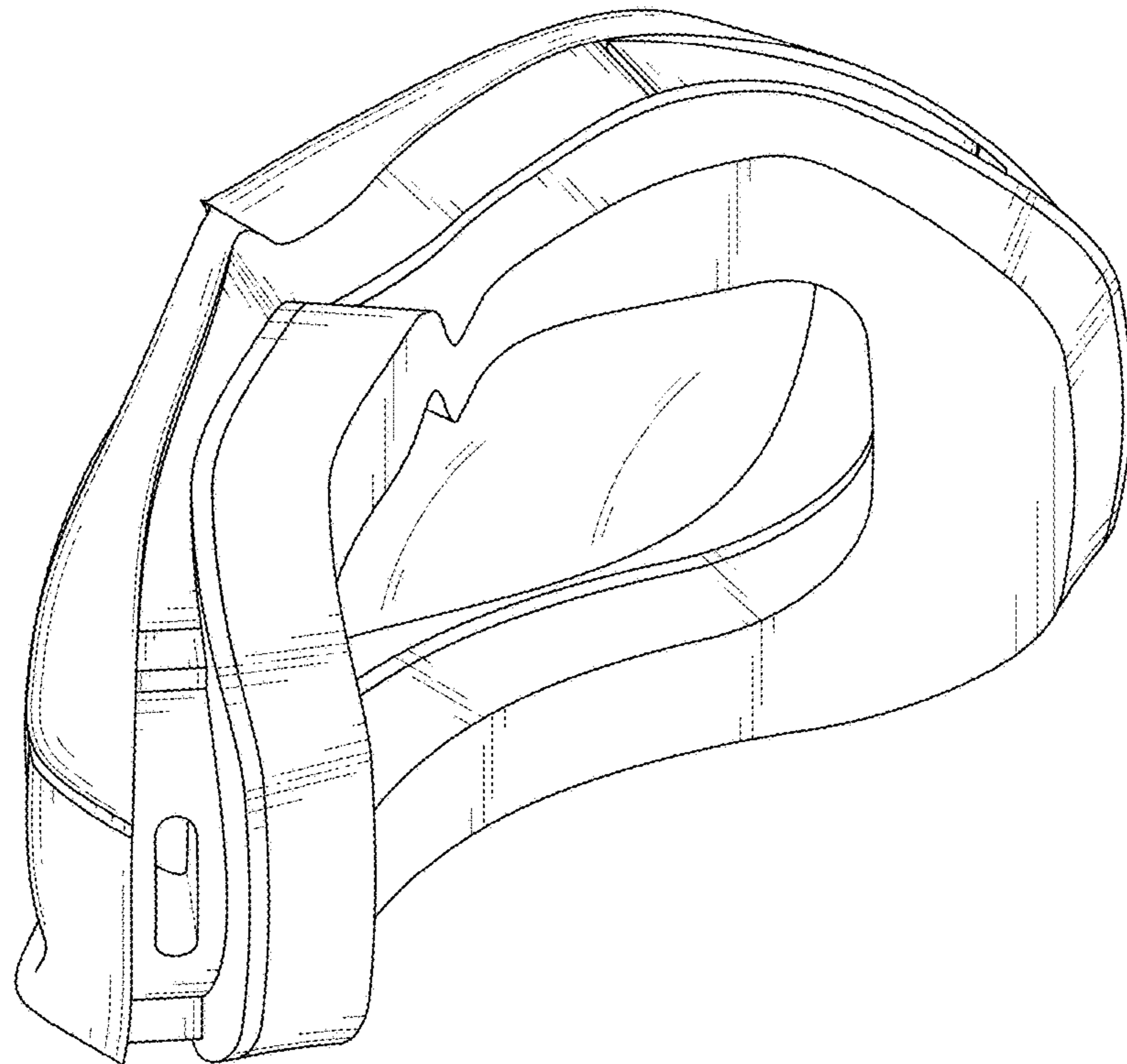

FIG. 2

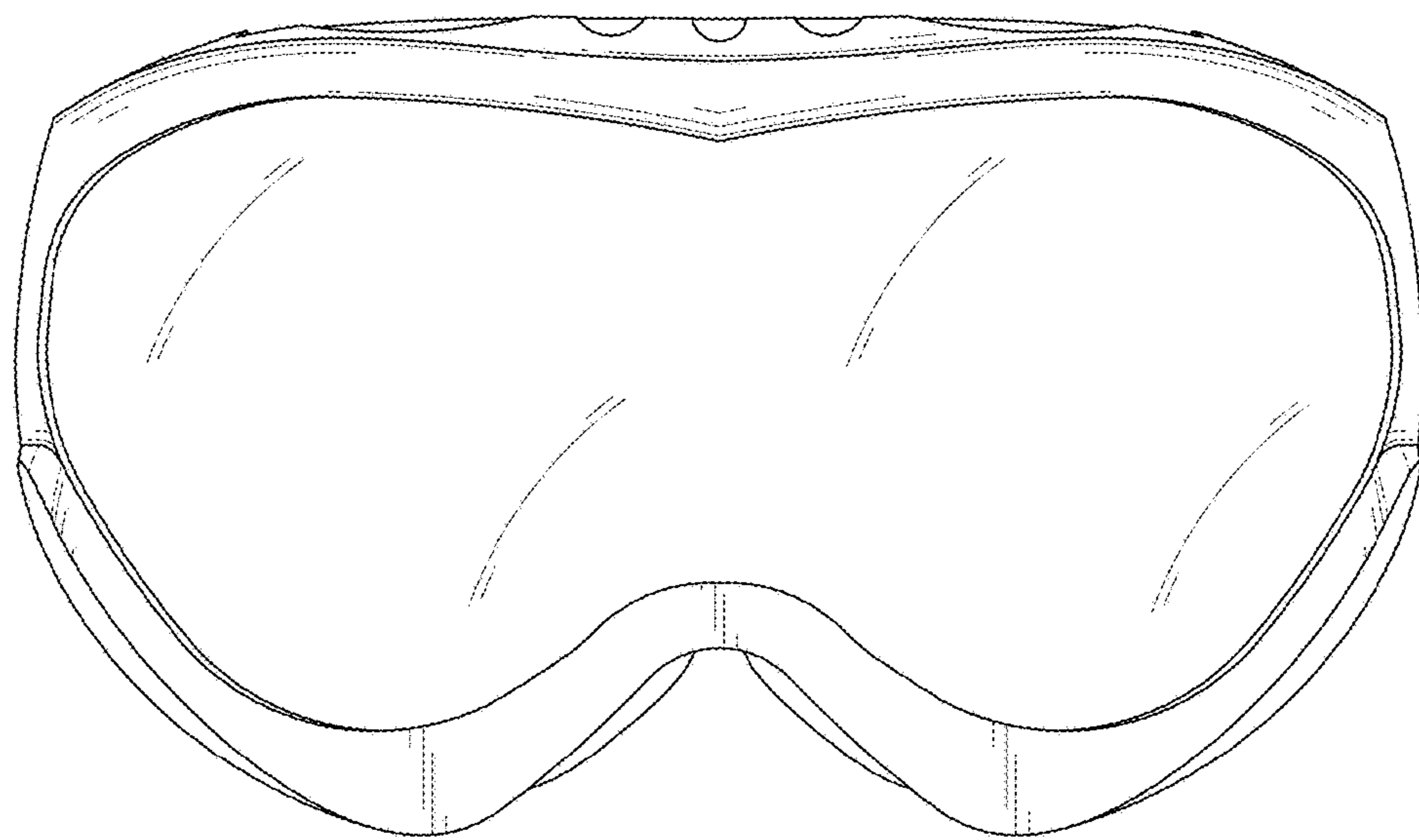

FIG. 3

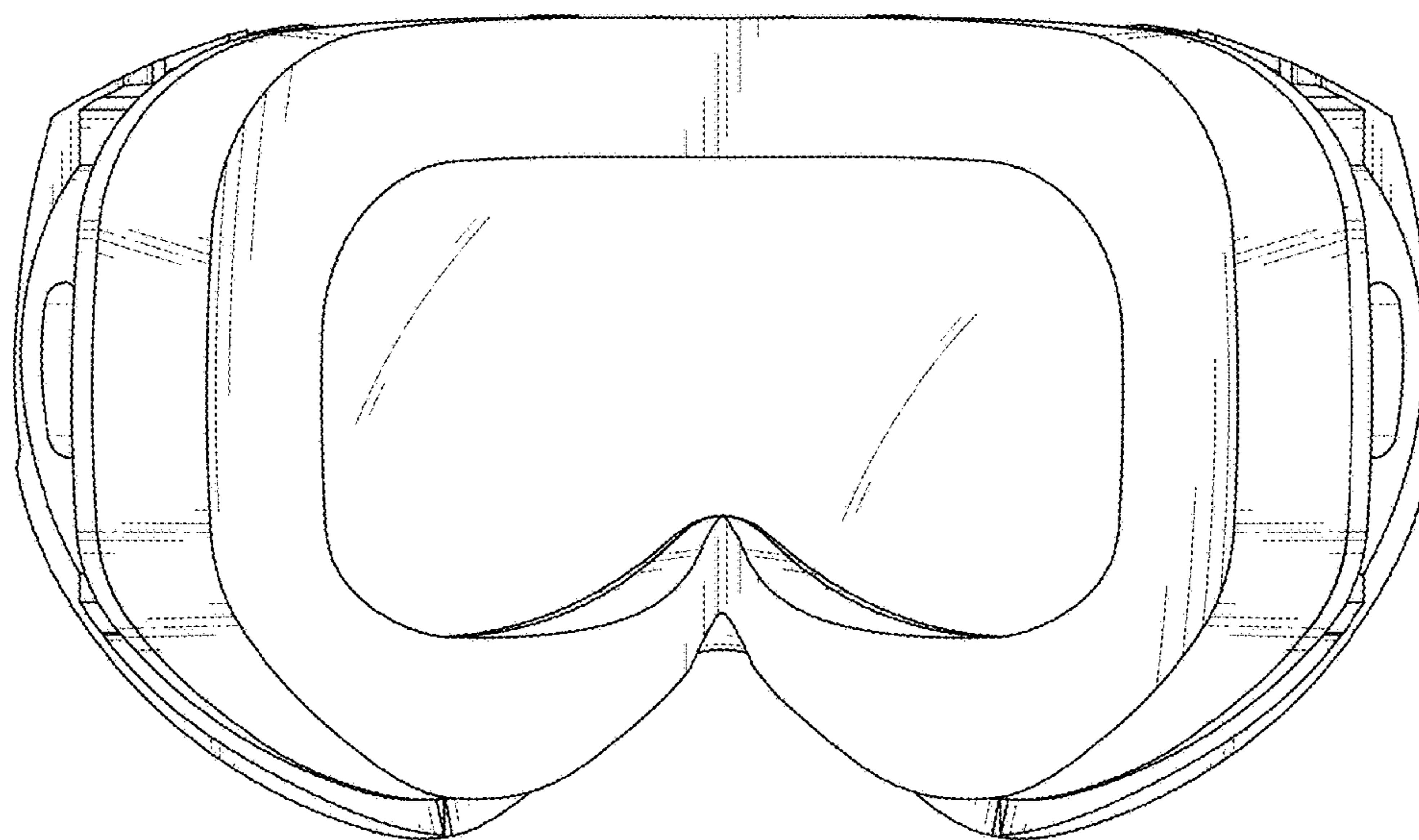

FIG. 4

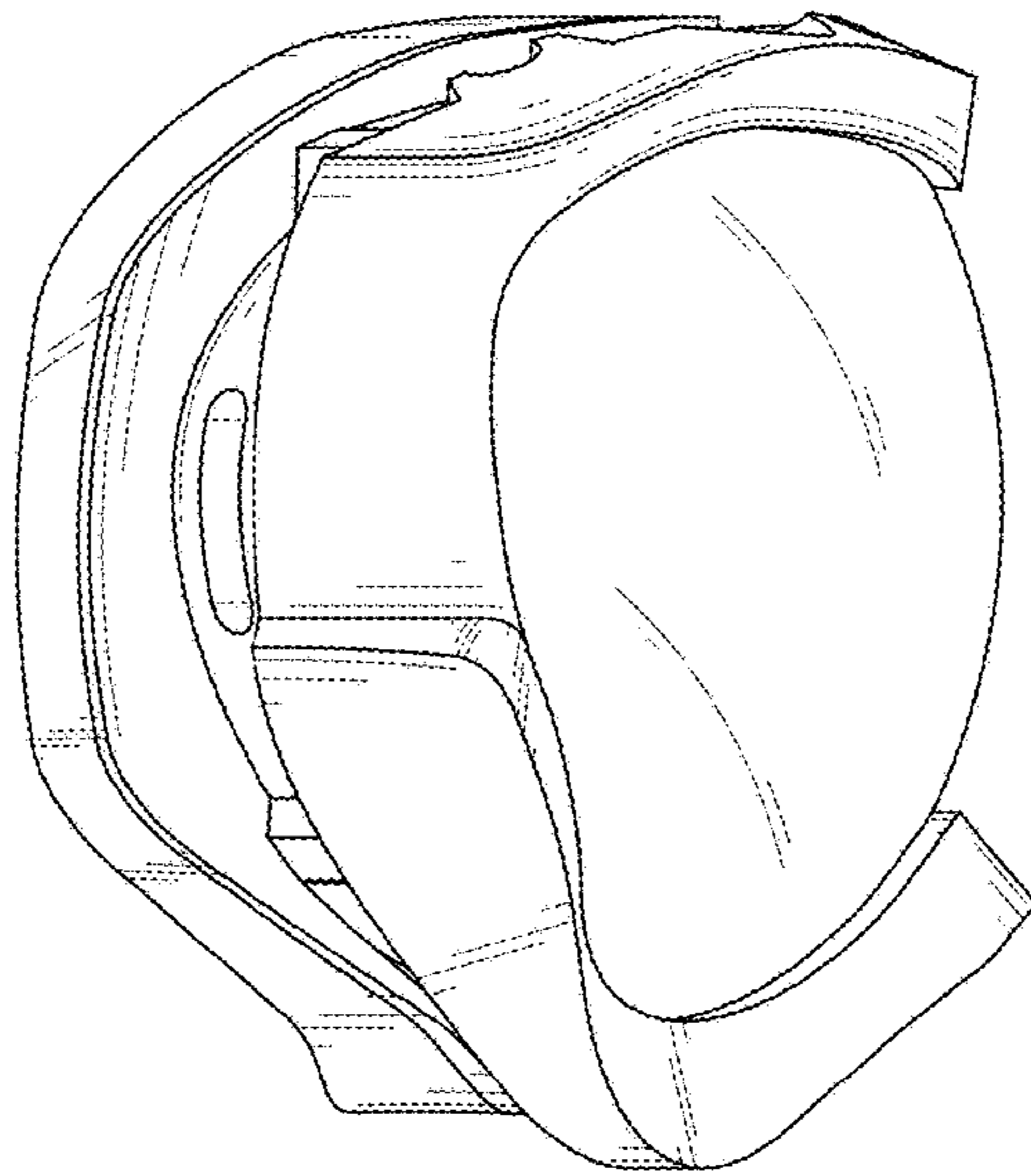

FIG. 5

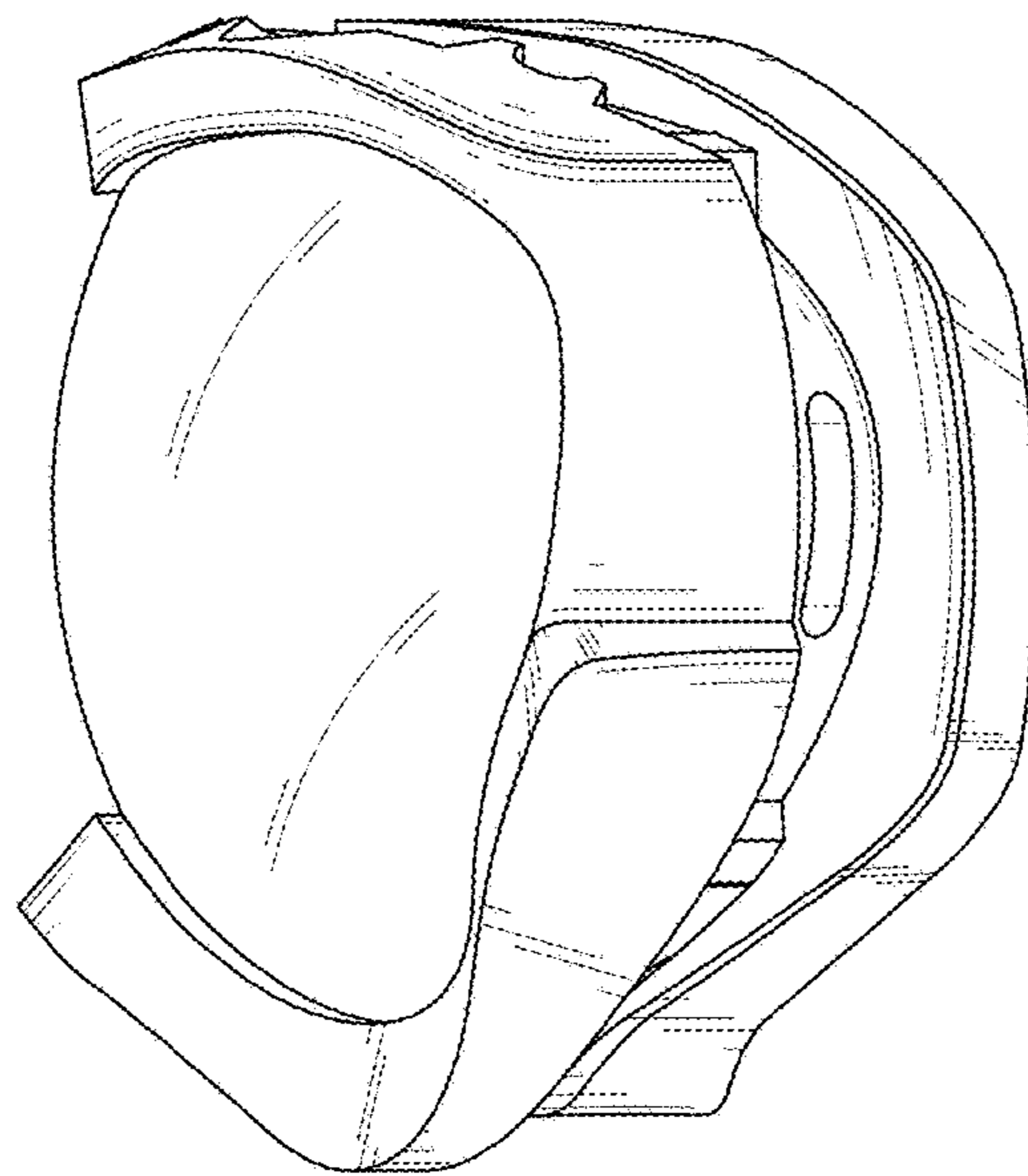

FIG. 6

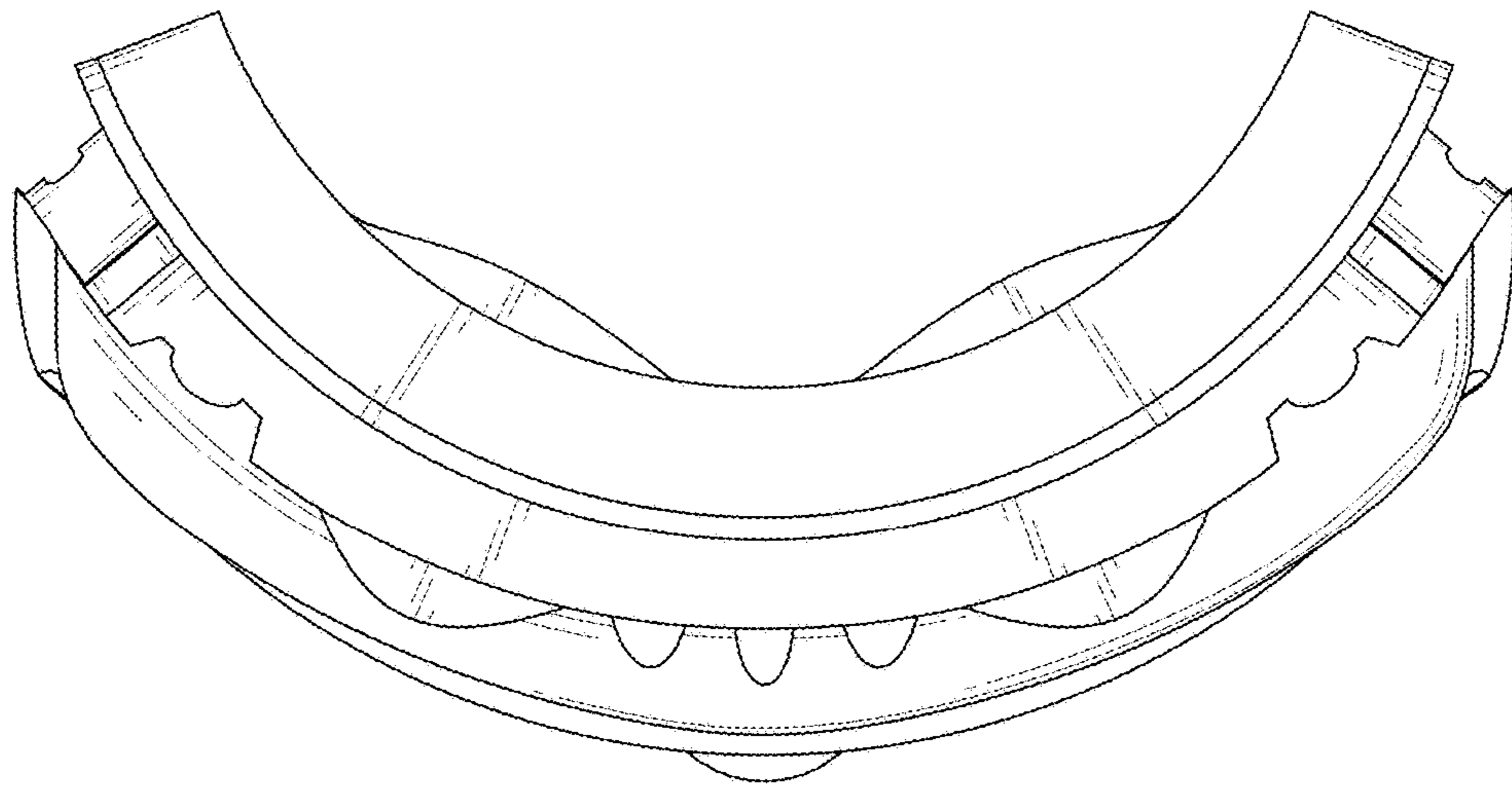

FIG. 7

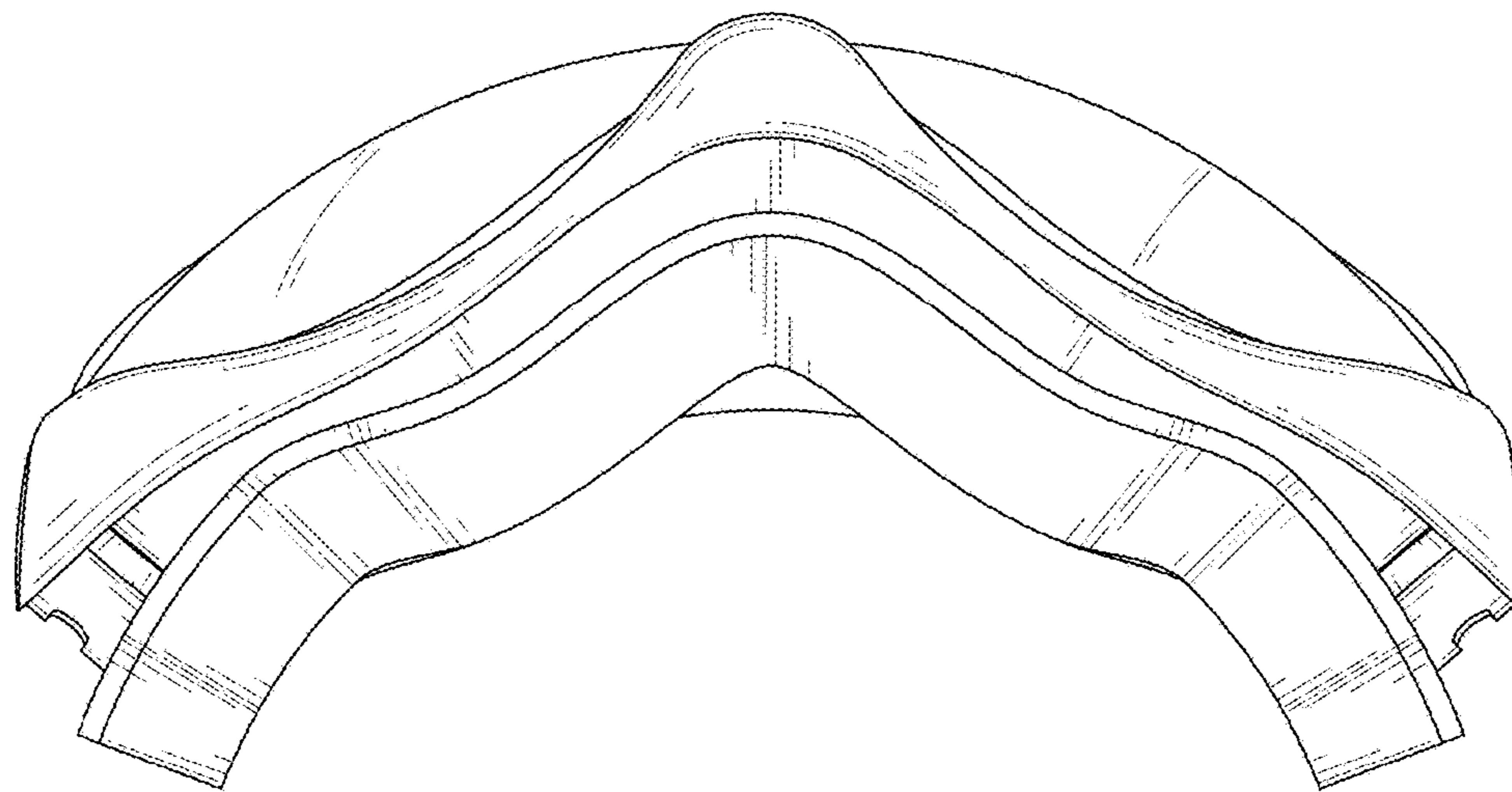

FIG. 8

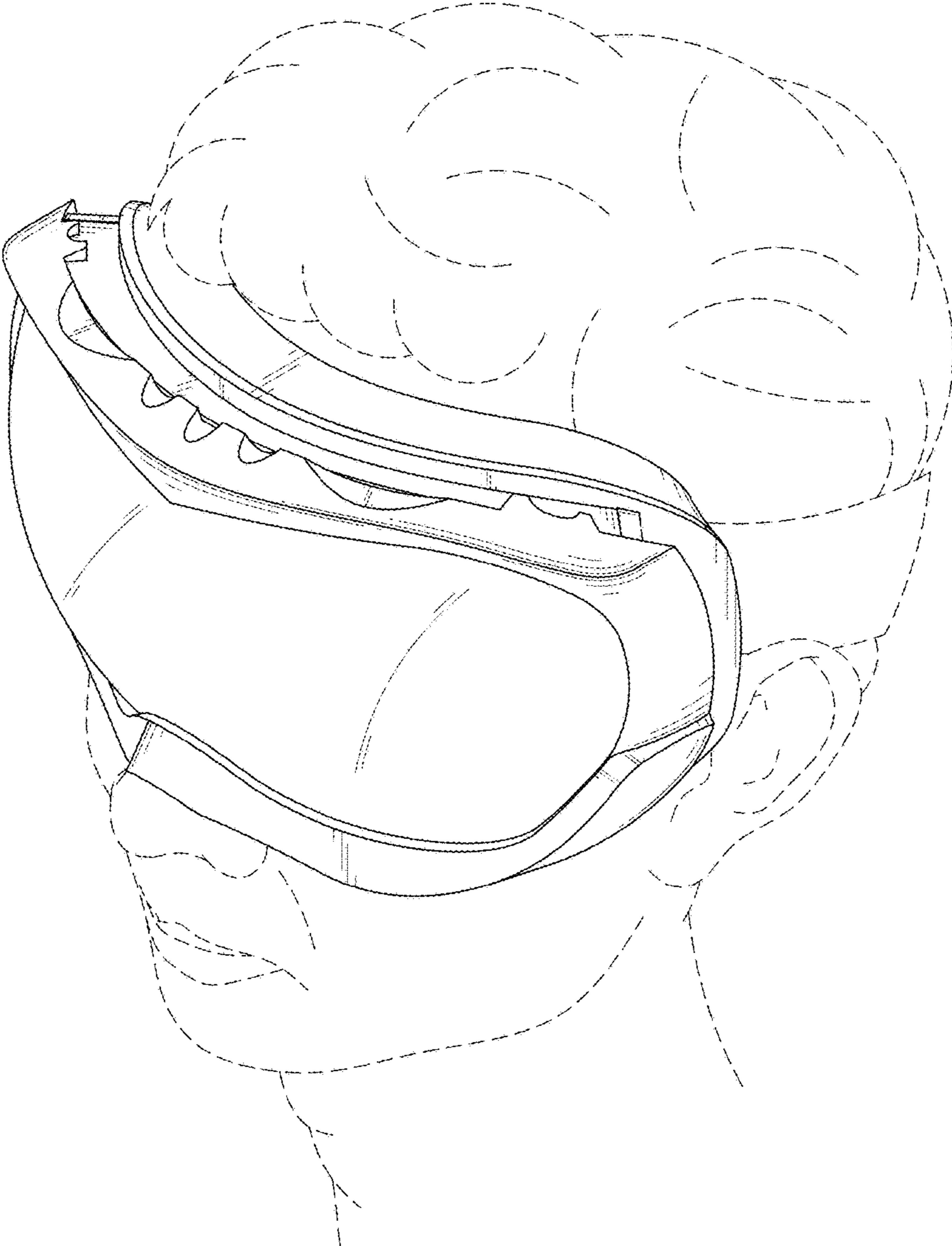

FIG. 9