

US00D869426S

(12) **United States Design Patent**  
**Sandlund**

(10) **Patent No.:** **US D869,426 S**

(45) **Date of Patent:** **\*\* Dec. 10, 2019**

(54) **MEDIA SERVER**

(71) Applicant: **DATATON AB**, Linköping (SE)

(72) Inventor: **Björn Sandlund**, Linköping (SE)

(73) Assignee: **DATATON AB**, Linköping (SE)

(\*\*) Term: **15 Years**

(21) Appl. No.: **29/628,937**

(22) Filed: **Dec. 8, 2017**

(30) **Foreign Application Priority Data**

Jun. 8, 2017 (EP) ..... 004037299

(51) **LOC (12) Cl.** ..... **14-01**

(52) **U.S. Cl.**  
USPC ..... **D14/203.1**

(58) **Field of Classification Search**

USPC ..... D14/158, 160–165, 167–168, 172,  
D14/188–189, 191, 203.1–203.6, 204,  
D14/207–216, 217, 218, 226, 249, 299,  
D14/341, 344, 345, 356, 358, 439, 480.1,  
D14/480.3–480.5, 496, 498–505, 510,  
D14/511, 257; D3/215, 218; D13/184

CPC ..... G06F 1/1613; G06F 1/163; G06F 1/1633;  
G06F 1/1681; G06F 13/10; G06F 13/12;  
H04M 1/0202; H04M 1/05; H04M  
1/6091; H04M 1/6066; H01R 12/00;  
H04B 1/385; H05K 5/00; H05K 5/03;  
H05K 5/04; G11B 33/00; G11B 33/02;  
G11B 33/022; G11B 33/027; G11B  
33/123; A63F 9/24; A63F 13/00; A63F  
13/12; G09G 5/00; G09G 5/12

See application file for complete search history.

(56) **References Cited**

**U.S. PATENT DOCUMENTS**

D304,823 S \* 11/1989 Pfeifer ..... D14/353  
D313,230 S \* 12/1990 Isaacs ..... D14/125

D313,795 S \* 1/1991 Bina ..... D14/355  
D331,227 S \* 11/1992 Esslinger ..... D14/355  
D441,375 S \* 5/2001 Hisatsune ..... D14/125  
D470,119 S \* 2/2003 Ota ..... D14/167  
D522,531 S \* 6/2006 Solomon ..... D14/188  
D529,903 S \* 10/2006 McRae ..... D14/240  
D563,994 S \* 3/2008 Liu ..... D14/356

(Continued)

**OTHER PUBLICATIONS**

Dataton's Media Player, online, post date Jun. 14, 2017, URL:  
<http://www.soundandcommunications.com/datatons-media-player/>,  
retrieved May 7, 2019.\*

(Continued)

*Primary Examiner* — Jeffery D Asch

*Assistant Examiner* — Rebekah A Caruso

(74) *Attorney, Agent, or Firm* — Moore & Van Allen  
PLLC; Jeffrey R. Gray

(57) **CLAIM**

The ornamental design for a media server, as shown and  
described.

**DESCRIPTION**

FIG. 1 is a front elevation view of a media server showing  
my new design.

FIG. 2 is a rear elevation view of the media server as shown  
in FIG. 1 showing my new design.

FIG. 3 is a left side elevation view of the media server as  
shown in FIG. 1 showing my new design.

FIG. 4 is a right side elevation view of the media server as  
shown in FIG. 1 showing my new design.

FIG. 5 is a top plan view of the media server as shown in  
FIG. 1 showing my new design.

FIG. 6 is a bottom plan view of the media server as shown  
in FIG. 1 showing my new design; and,

FIG. 7 is a front perspective view of the media server as  
shown in FIG. 1 showing my new design.

**1 Claim, 7 Drawing Sheets**

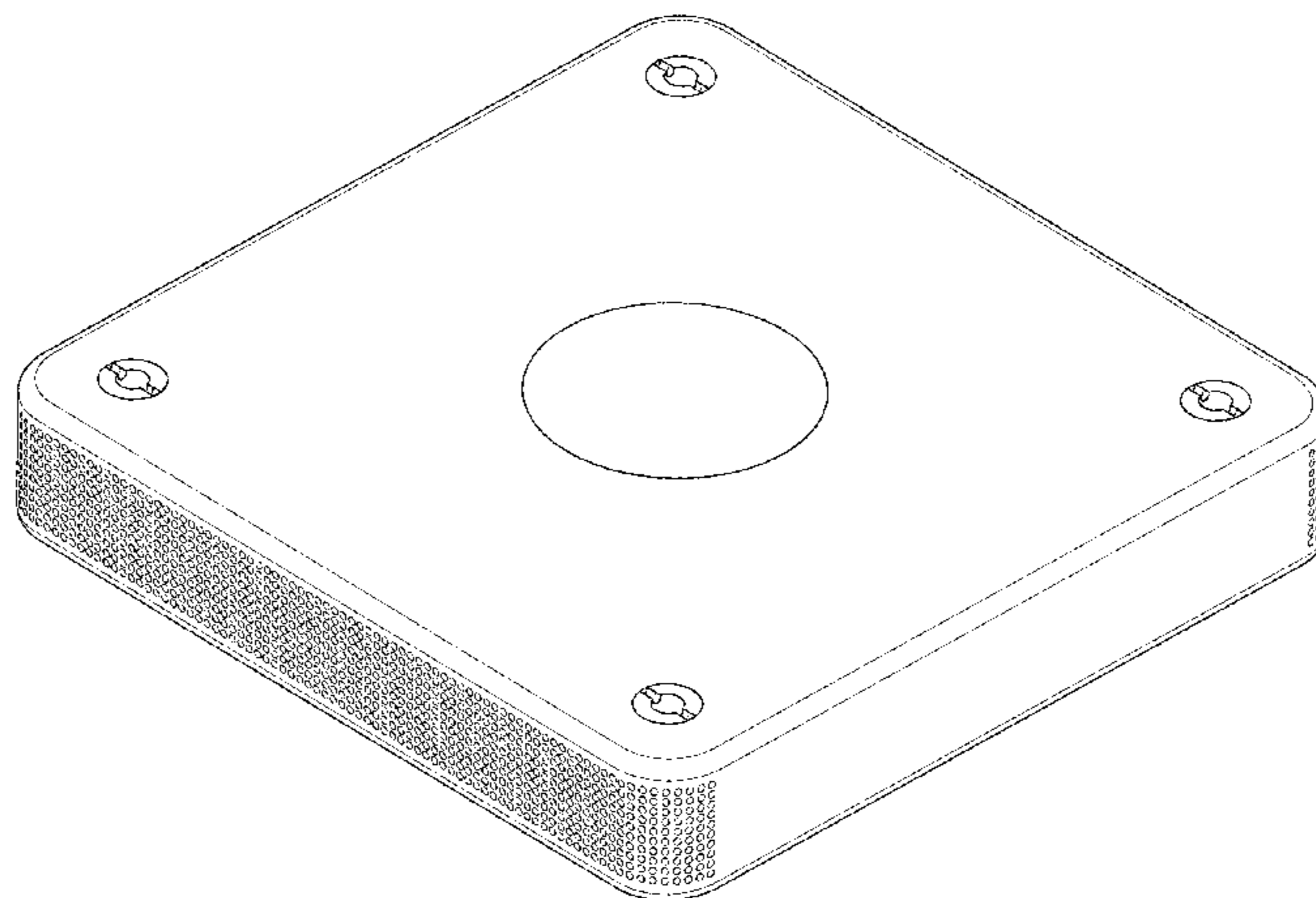

(56)

**References Cited**

U.S. PATENT DOCUMENTS

D601,980	S	*	10/2009	Ogawa	.....	D14/125
D620,953	S	*	8/2010	Andre	.....	D14/203.3
D650,394	S	*	12/2011	Seoc	.....	D14/496
D722,587	S	*	2/2015	Green	.....	D14/188
D752,529	S	*	3/2016	Loretan	.....	D14/125
D765,066	S	*	8/2016	Cowles	.....	D14/240
D810,044	S	*	2/2018	Ohmachi	.....	D14/188
D820,244	S	*	6/2018	Cowles	.....	D14/239
D836,619	S	*	12/2018	Yokoyama	.....	D14/240
D844,006	S	*	3/2019	Molnar	.....	D14/434
D844,578	S	*	4/2019	Seflic	.....	D14/125
D844,619	S	*	4/2019	Wendling	.....	D14/434

OTHER PUBLICATIONS

Dataton Launches New Media Server: WATCHPAX, online, post date May 21, 2013, URL: <http://isquint.net/2013/dataton-launches-new-media-server-watchpax/> , retrieved May 7, 2019.\*

\* cited by examiner

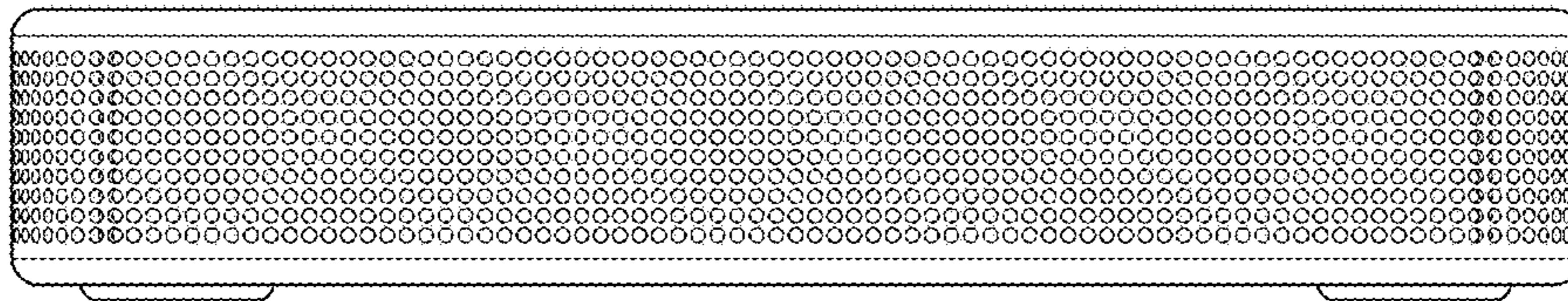

FIG. 1

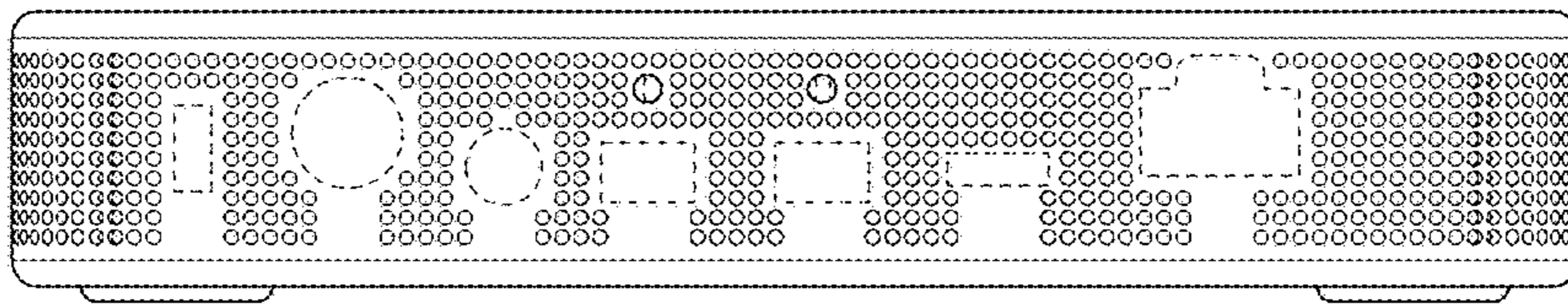

FIG. 2

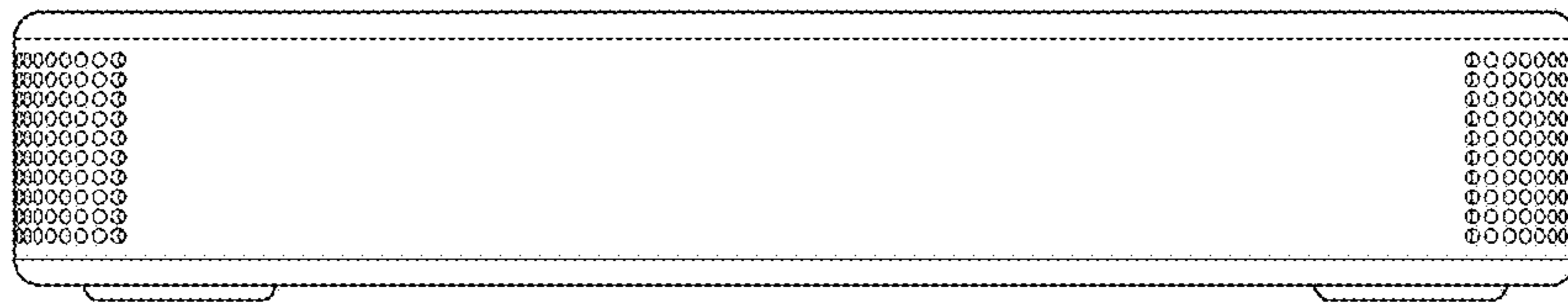

FIG. 3

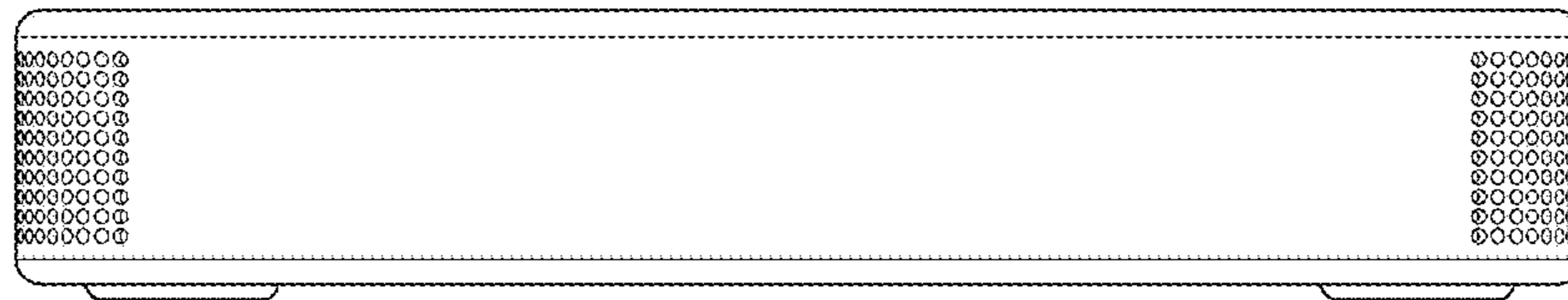

FIG. 4

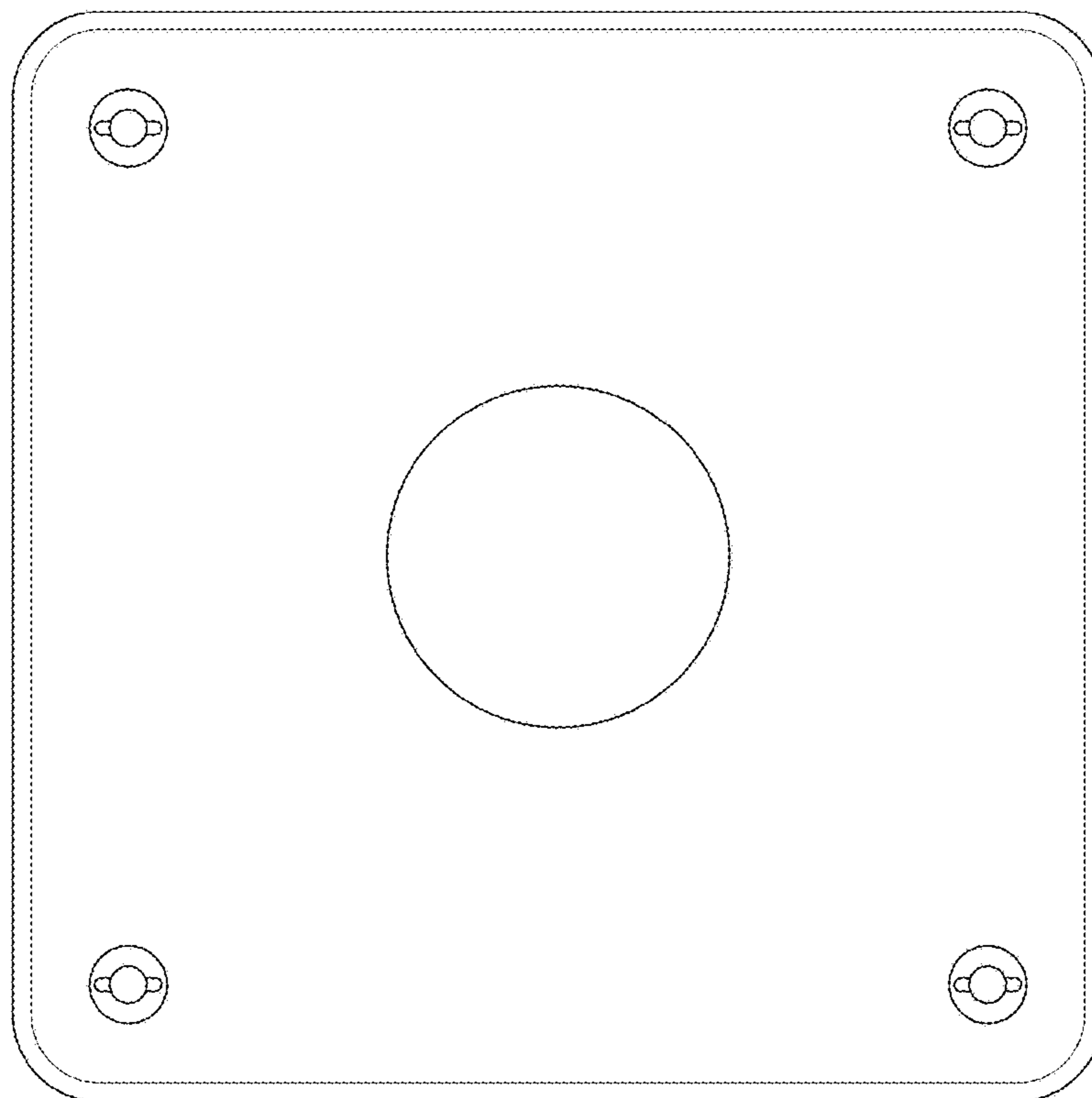

FIG. 5



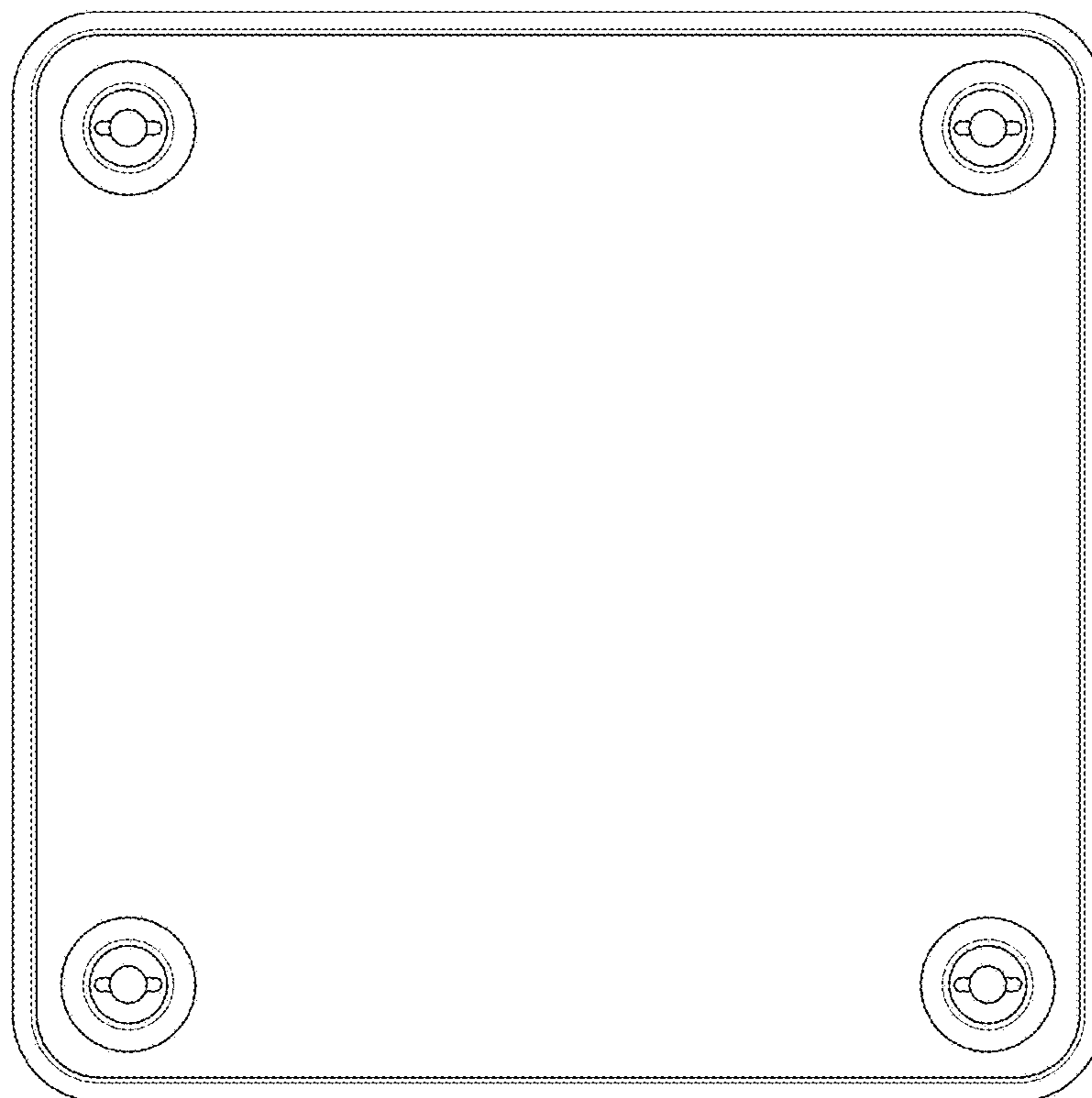

FIG. 6



