



US00D869393S

(12) **United States Design Patent** (10) **Patent No.:** **US D869,393 S**  
**Urasini et al.** (45) **Date of Patent:** **\*\* Dec. 10, 2019**

(54) **CHARGING DOCK** 13/6675; H01M 2/1022; H01M 2/1055;  
H01M 10/44; H01M 10/46; H01M  
(71) Applicant: **PHILIP MORRIS PRODUCTS S.A.,** 10/425; B60L 11/182  
Neuchâtel (CH) See application file for complete search history.

(72) Inventors: **Sara Urasini**, Bray (IE); **Florent Cuchet**, Stockholm (SE); **Peter Bevan**, Greystones (IE); **Bayden Filleul**, Temple Bar (IE); **Michael Nolan**, Rathgar (IE)

(73) Assignee: **PHILIP MORRIS PRODUCTS S.A.,** Neuchatel (CH)

(\*\*) Term: **15 Years**

(21) Appl. No.: **35/504,797**

(22) Filed: **Oct. 20, 2017**

(80) **Hague Agreement Data**

Int. Filing Date: **Oct. 20, 2017**

Int. Reg. No.: **DM/099361**

Int. Reg. Date: **Oct. 20, 2017**

Int. Reg. Pub. Date: **Apr. 20, 2018**

(30) **Foreign Application Priority Data**

Apr. 21, 2017 (EM) ..... 003865708-0001  
Apr. 21, 2017 (EM) ..... 003865708-0003  
Apr. 21, 2017 (EM) ..... 003865708-0005  
Apr. 21, 2017 (EM) ..... 003865708-0006

(51) **LOC (12) Cl.** ..... **13-02**

(52) **U.S. Cl.**  
USPC ..... **D13/108**

(58) **Field of Classification Search**

USPC ..... D13/107-110, 118-119, 184; D14/251,  
D14/253, 432, 434; D6/512, 524;  
D9/734, 432

CPC ..... Y02E 60/12; Y02T 90/14; Y02T 90/122;  
Y02T 90/128; Y02T 90/163; H02J 7/025;  
H02J 7/0042; H02J 7/0044; H02J 7/0045;  
H02J 7/0003; H01F 38/14; H01R

(56) **References Cited**

U.S. PATENT DOCUMENTS

D274,903 S \* 7/1984 Eckmann ..... D13/107  
D278,295 S \* 4/1985 Thompson ..... D6/518  
D279,181 S \* 6/1985 Claxton ..... D13/107  
D477,823 S \* 7/2003 Lavello, Sr. .... D14/149  
D495,336 S \* 8/2004 Andre ..... D14/434

(Continued)

FOREIGN PATENT DOCUMENTS

AU 360099 4/2014  
CN 302789796 S 4/2014

(Continued)

OTHER PUBLICATIONS

Israeli Office Action dated Aug. 14, 2018 (no English translation provided).

(Continued)

*Primary Examiner* — Barbara Fox

*Assistant Examiner* — Nathaniel D. Buckner

(74) *Attorney, Agent, or Firm* — Oblon, McClelland, Maier & Neustadt, L.L.P.

(57) **CLAIM**

The ornamental design for a charging dock, as shown and described.

**DESCRIPTION**

2. Charging Dock

Design 2: fig. 2.1 is a front, top, and left side perspective view; fig. 2.2 is a front view; fig. 2.3 is a back view; fig. 2.4

(Continued)

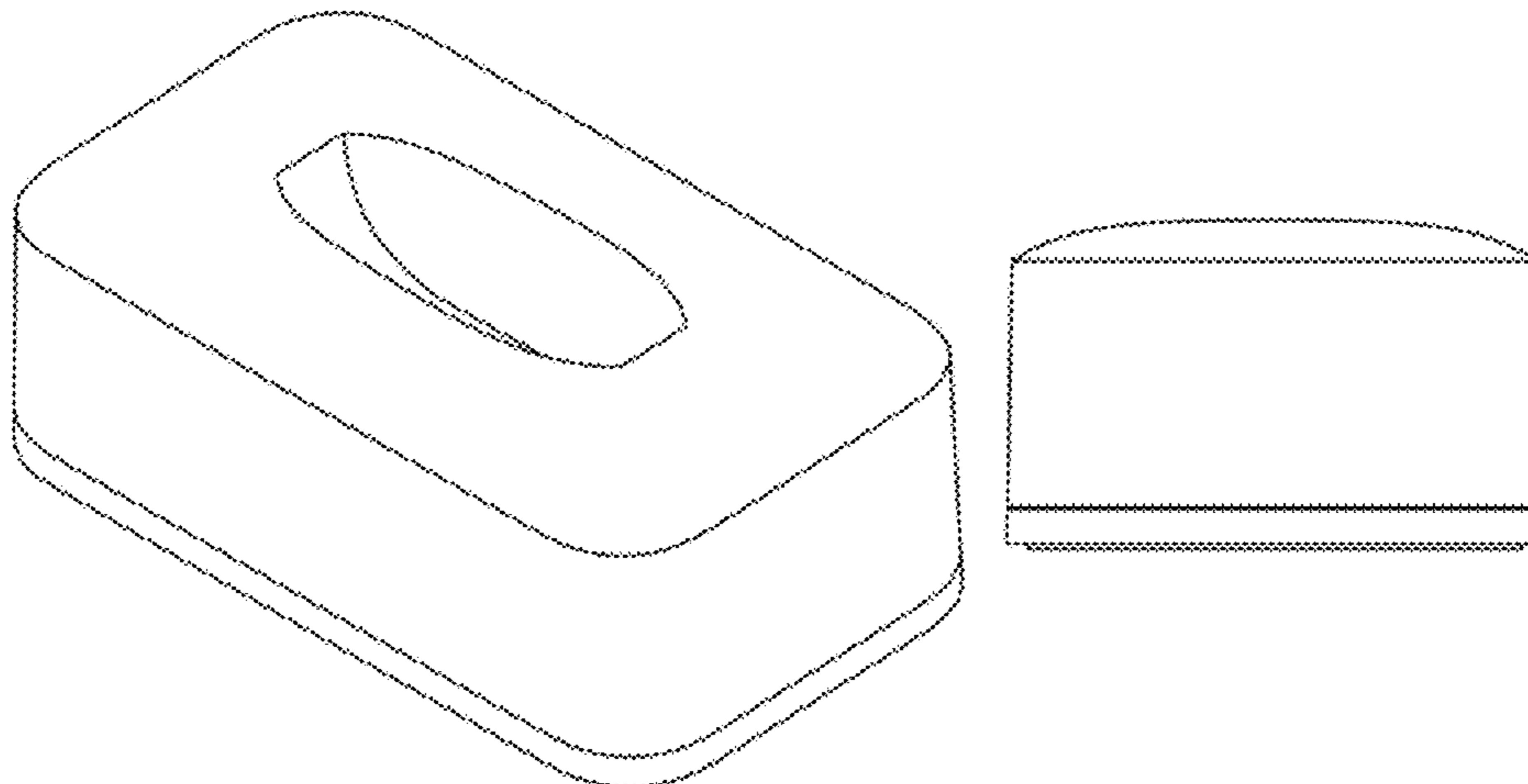

is a left side view; fig. 2.5 is a right side view; fig. 2.6 is a top view; and fig. 2.7 is a bottom view.

**1 Claim, 7 Drawing Sheets**

(56)

**References Cited**

U.S. PATENT DOCUMENTS

D558,739 S \* 1/2008 Andre ..... D14/217  
 D590,770 S \* 4/2009 Moss ..... D13/108  
 7,665,628 B1 \* 2/2010 Milligan ..... A47K 10/422  
 221/213  
 7,719,830 B2 \* 5/2010 Howarth ..... G06F 1/1632  
 312/223.2  
 D643,398 S \* 8/2011 Zakarias ..... D14/148  
 D660,794 S 5/2012 Fahrendorff et al.  
 D685,392 S \* 7/2013 Chamness ..... D14/496  
 D710,797 S \* 8/2014 Awiszus ..... D13/107  
 D722,961 S 2/2015 Lin et al.  
 D726,690 S \* 4/2015 Andre ..... D14/217  
 D727,257 S 4/2015 Miller et al.  
 D745,456 S 12/2015 Fung et al.  
 D751,079 S \* 3/2016 Skjoldborg ..... D14/434  
 D764,404 S 8/2016 Lau et al.  
 D783,525 S 4/2017 Gupta et al.  
 D806,019 S \* 12/2017 Wang ..... D13/107  
 D811,767 S \* 3/2018 Li ..... D6/518  
 2015/0245746 A1 \* 9/2015 Chorne ..... A47K 10/422  
 221/1  
 2016/0120378 A1 \* 5/2016 Matthews ..... A47K 10/421  
 221/45

FOREIGN PATENT DOCUMENTS

CN 303059048 S 12/2014  
 CN 304072464 S 3/2017  
 CN 304344809 S 11/2017  
 JP D1071789 5/2000  
 JP 2000211679 A \* 8/2000  
 JP D1277483 S 7/2006  
 JP D1381389 S 3/2010  
 JP 1500012 S 6/2014  
 JP D1570646 2/2017  
 JP D1574479 4/2017  
 JP D1581073 7/2017  
 KR 30-0574040 10/2010  
 KR 30-06212540 9/2011  
 KR 30-0740841 4/2014  
 KR 30-0785298 2/2015  
 KR 30-0855862 S 5/2016  
 KR 30-0871492 9/2016  
 KR 30-0901646 4/2017

OTHER PUBLICATIONS

<http://www.asiaone.com/digital/prolong-your-smartphones-battery-life-5-best-portable-chargers-market> Digital Life, Jul. 25, 2014.  
 Taiwanese Search Report for corresponding TW106306222, dated Feb. 13, 2019. English translation provided.  
 Taiwanese Search Report for corresponding TW107306370, dated Apr. 19, 2019. English translation provided.  
 Taiwanese Search Report for corresponding TW107306371, dated Jan. 25, 2019. English translation provided.  
 Taiwanese Search Report for corresponding TW107306372, dated Mar. 26, 2019. English translation provided.  
 Vietnamese Office Action dated Apr. 18, 2019, in Design Application No. 3-2017-02197, 2 pages.

\* cited by examiner

2.1

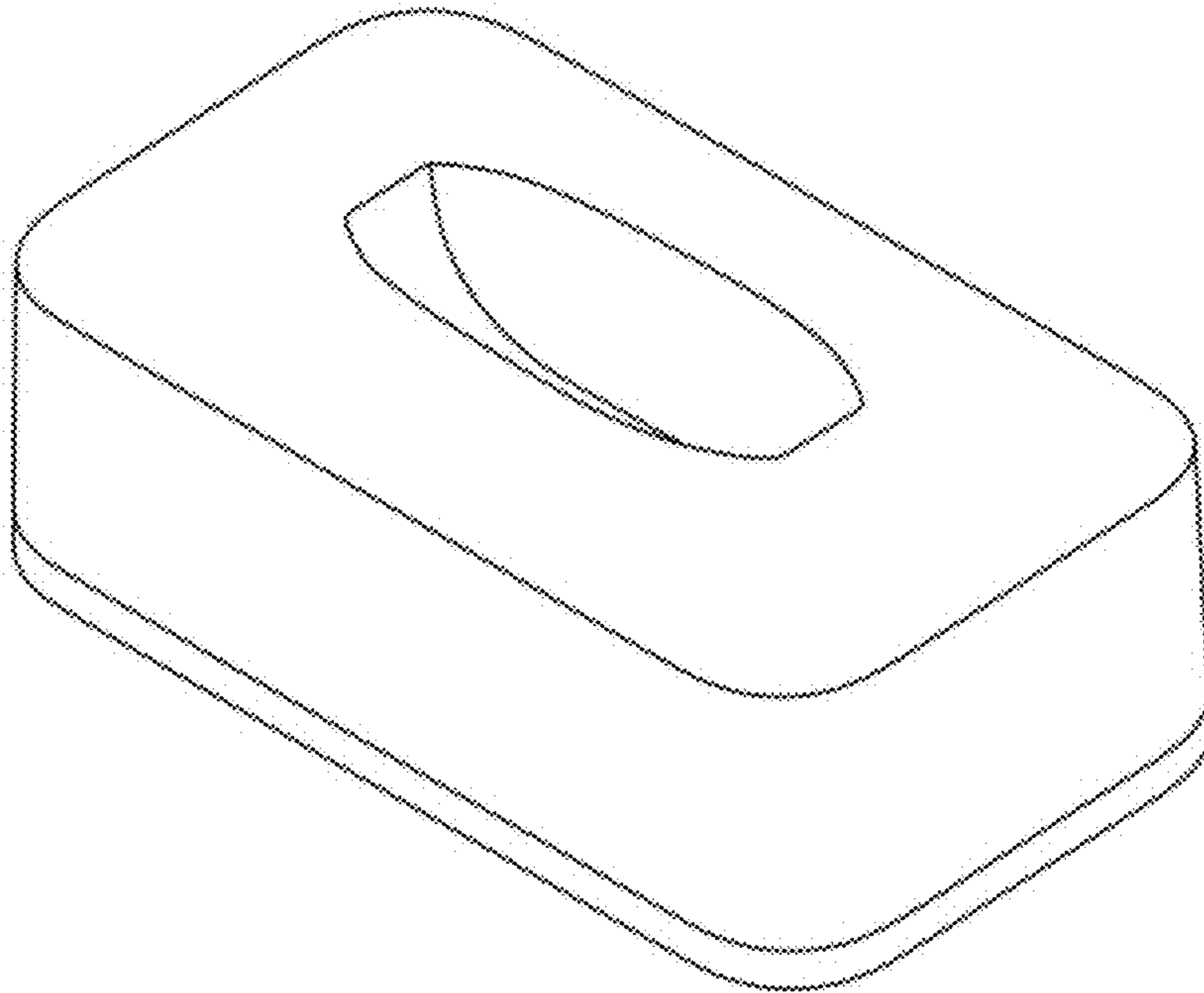

2.2

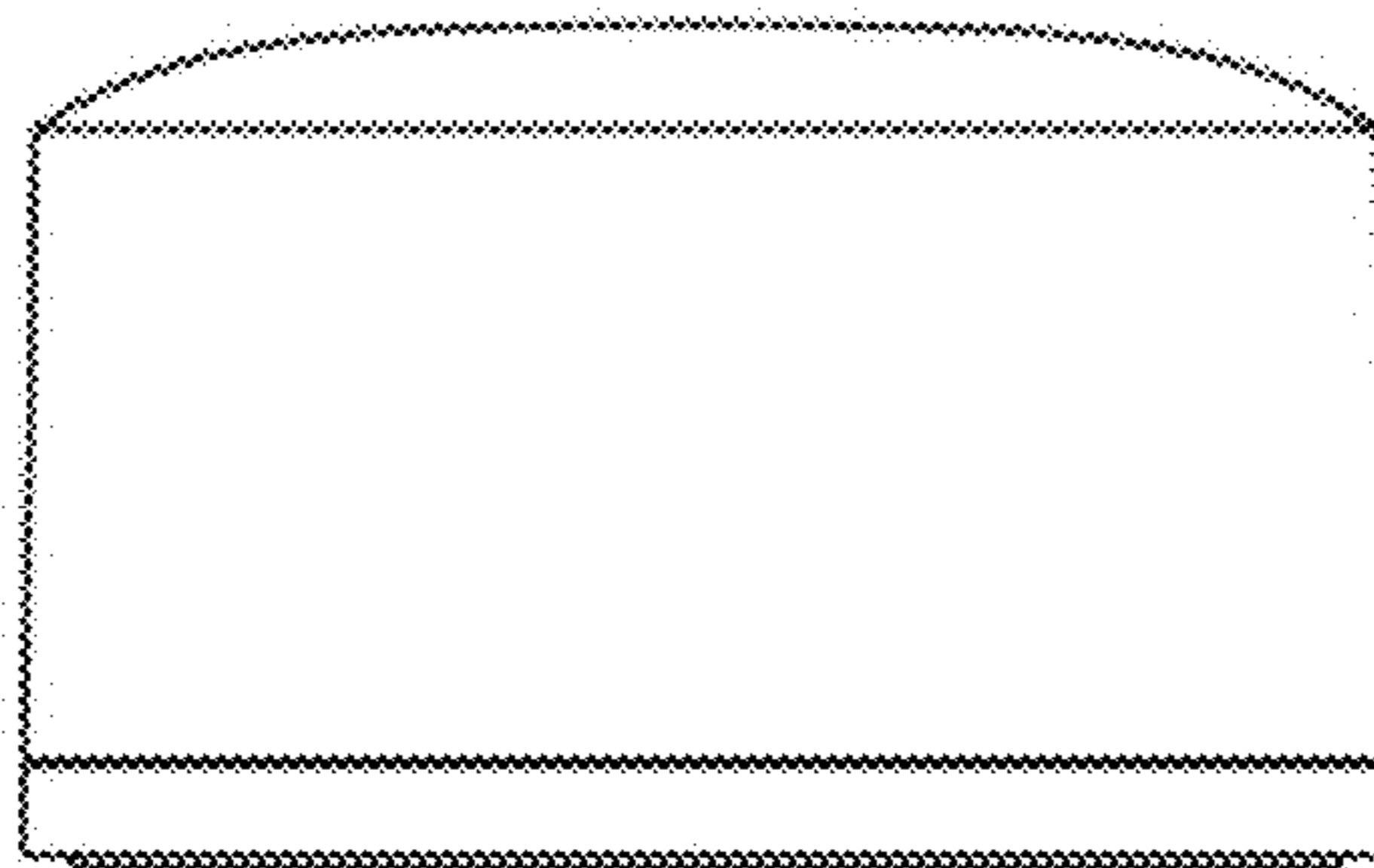

2.3

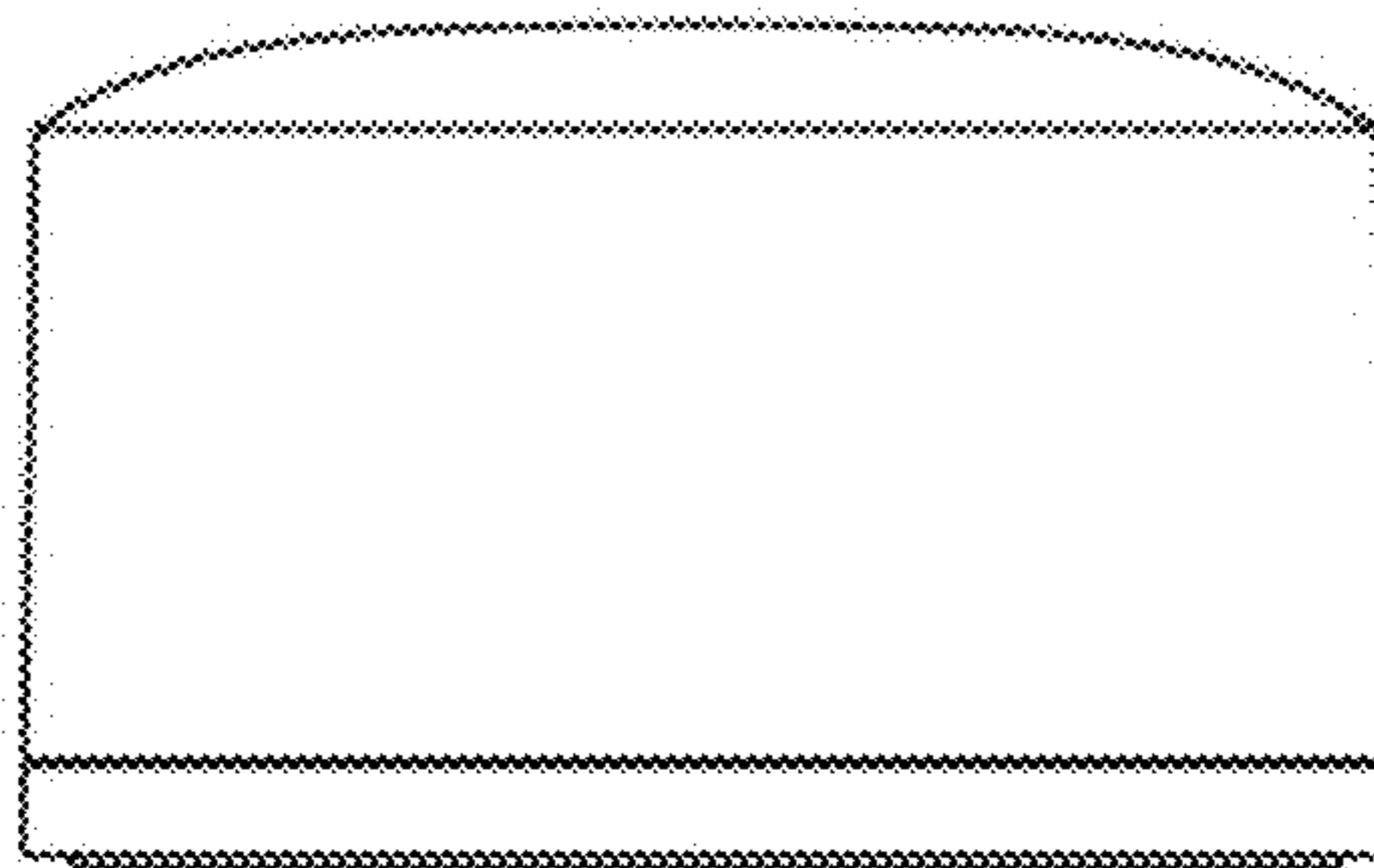

2.4

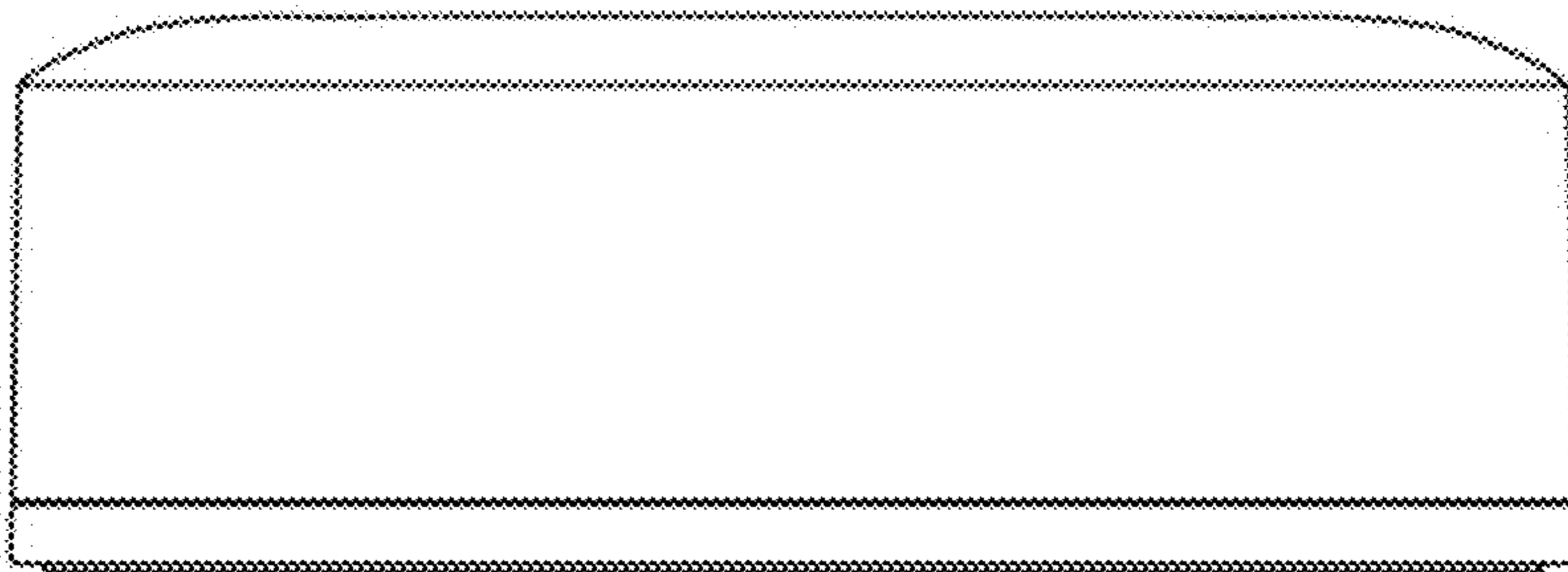

2.5

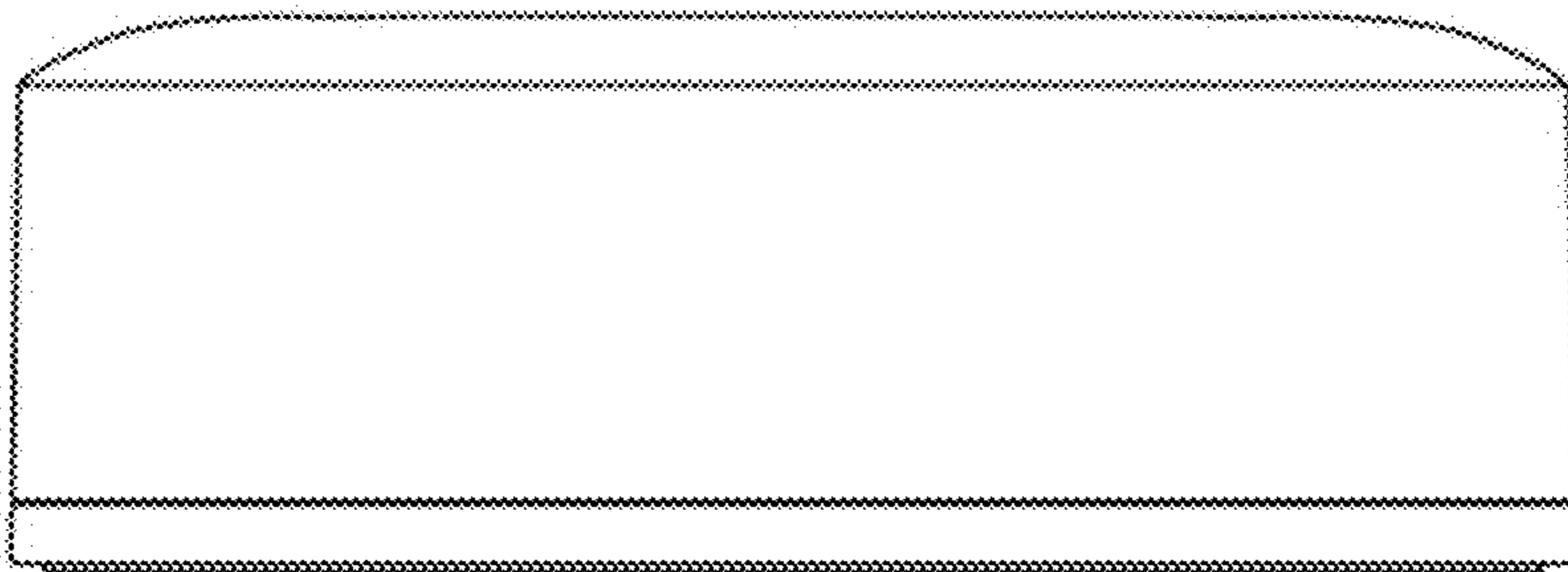

2.6

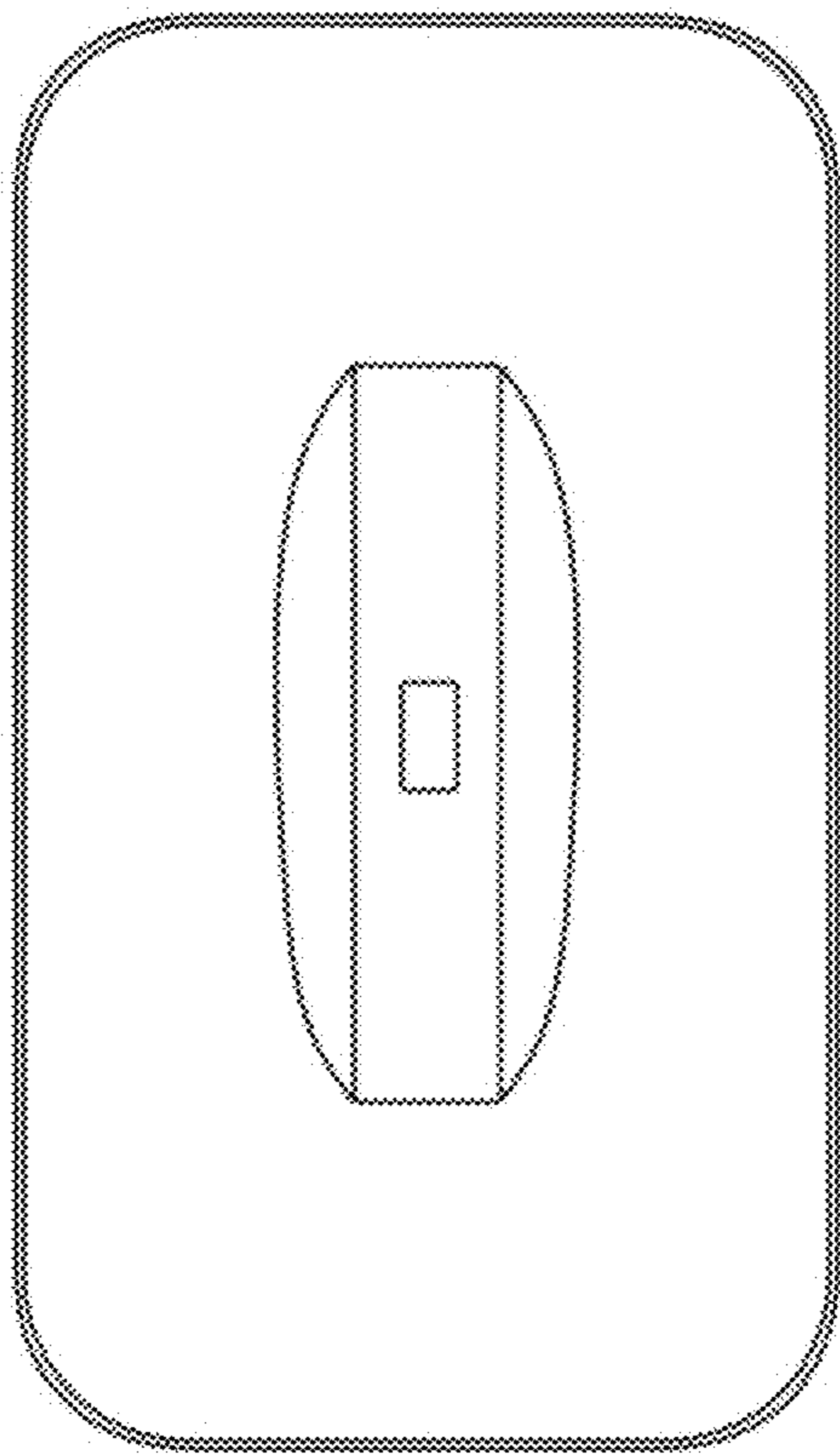



2.7

