



US00D869369S

(12) **United States Design Patent** (10) **Patent No.:** **US D869,369 S**  
**Rogers** (45) **Date of Patent:** **\*\* Dec. 10, 2019**

(54) **PADDLE BLADE**

D361,344 S \* 8/1995 Cugley ..... D12/215  
D362,834 S \* 10/1995 Stout ..... D12/215  
D363,458 S \* 10/1995 Killen ..... D12/215

(71) Applicant: **CAMCO Manufacturing, Inc.**,  
Greensboro, NC (US)

(Continued)

(72) Inventor: **Thomas Wayne Rogers**, Brentwood,  
TN (US)

*Primary Examiner* — Michelle E. Wilson

*Assistant Examiner* — Clese Moore, Jr.

(73) Assignee: **Camco Manufacturing, Inc.**,  
Greensboro, NC (US)

(74) *Attorney, Agent, or Firm* — Tuggle Duggins P.A.;  
Blake P. Hurt

(\*\*) Term: **15 Years**

(57) **CLAIM**

What is claimed is the ornamental design for a paddle blade,  
as shown and described.

(21) Appl. No.: **29/666,968**

**DESCRIPTION**

(22) Filed: **Oct. 17, 2018**

FIG. 1 is a rear perspective view showing a paddle blade of  
Applicant's invention.

(51) **LOC (12) Cl.** ..... **12-06**

FIG. 2 is a front perspective view of the paddle blade of FIG.  
1.

(52) **U.S. Cl.**

FIG. 3 is a top plan view of the paddle blade of FIG. 1.

USPC ..... **D12/215**

FIG. 4 is a right side elevational view of the paddle blade of  
FIG. 1.

(58) **Field of Classification Search**

USPC ..... D12/215, 300, 302, 317

CPC ..... B63H 16/04; B63H 16/046

See application file for complete search history.

FIG. 5 is a left side elevational view of the paddle blade of  
FIG. 1.

FIG. 6 is a cross-sectional view of the paddle blade of FIG.  
1 taken along line 6-6 as shown in FIG. 3.

FIG. 7 is a cross-sectional view of the paddle blade of FIG.  
1 taken along line 7-7 as shown in FIG. 3.

FIG. 8 is a cross-sectional view of the paddle blade of FIG.  
1 taken along line 8-8 as shown in FIG. 4.

FIG. 9 a bottom plan view of the paddle blade of FIG. 1.

FIG. 10 is a front elevational view of the paddle blade of  
FIG. 1; and,

FIG. 11 is a rear elevational view of the paddle blade of FIG.  
1.

The dash-dash broken lines shown in the drawings illustrate  
portions and environment of the paddle blade that form no  
part of the claimed design.

The dash-dot broken lines shown in the drawings illustrate  
the boundary of the paddle blade that form no part of the  
claimed design.

(56) **References Cited**

**U.S. PATENT DOCUMENTS**

D191,890 S \* 12/1961 Clark et al. .... D12/215  
3,030,641 A \* 4/1962 Ake ..... B63H 16/04  
416/71  
D204,525 S \* 4/1966 Borse ..... D12/215  
D213,472 S \* 3/1969 Castloo ..... D12/215  
D216,227 S \* 12/1969 Nichols ..... D12/215  
D216,344 S \* 12/1969 Nichols ..... D12/215  
D244,680 S \* 6/1977 Leidigh ..... D12/215  
D260,254 S \* 8/1981 Heller ..... D12/215  
4,610,633 A \* 9/1986 Freudenberg ..... B63H 16/04  
416/74  
4,622,017 A \* 11/1986 McGraw ..... B63H 16/04  
416/74  
D297,927 S \* 10/1988 Keal ..... D12/215  
D335,274 S \* 5/1993 Beckerer, Jr. .... D12/215

**1 Claim, 3 Drawing Sheets**

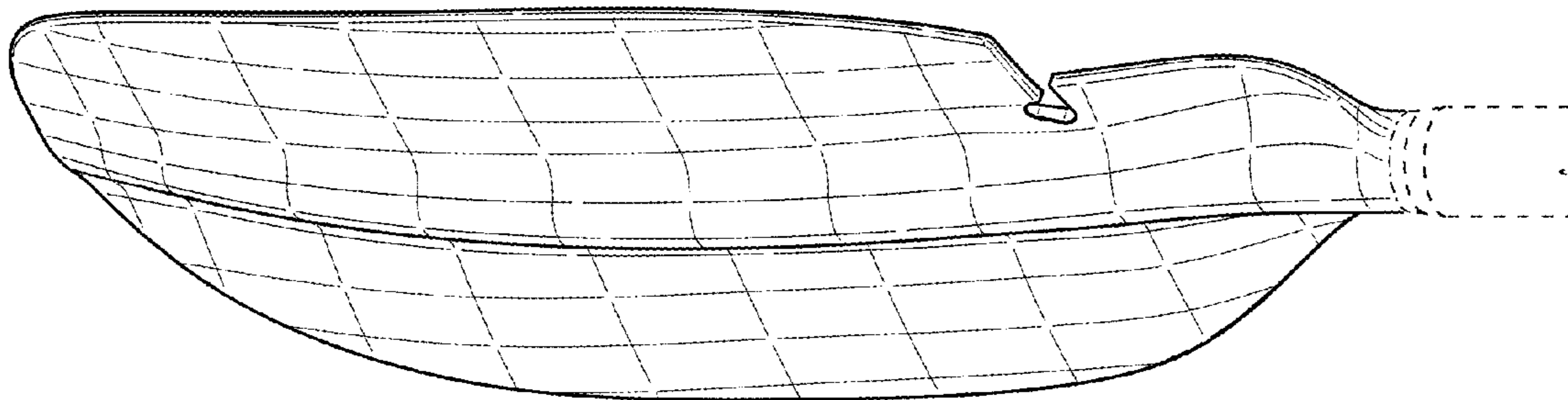

(56)

**References Cited**

U.S. PATENT DOCUMENTS

D441,653 S \* 5/2001 LeRoux ..... D9/434  
6,328,617 B1 \* 12/2001 Gunnell ..... B63H 16/04  
416/70 R  
D460,399 S \* 7/2002 Peng ..... D12/215  
D519,798 S \* 5/2006 Dallas ..... D8/20  
D578,054 S \* 10/2008 Peng ..... D12/215  
D578,055 S \* 10/2008 Halm ..... D12/215  
D598,358 S \* 8/2009 Bradley ..... D12/215  
D616,723 S \* 6/2010 Lyden ..... D8/351  
D617,628 S \* 6/2010 Lyden ..... D8/351  
D693,285 S \* 11/2013 Hall ..... D12/215  
8,632,371 B1 \* 1/2014 Ramsey ..... B63H 16/04  
440/101  
D728,890 S \* 5/2015 Reed ..... D34/28  
D737,015 S \* 8/2015 Reed ..... D34/28  
D804,392 S \* 12/2017 Harvell ..... D12/215  
2006/0105649 A1 \* 5/2006 Jones ..... B63H 16/04  
441/56  
2014/0332639 A1 \* 11/2014 Ahlem ..... A01J 7/00  
248/68.1

\* cited by examiner

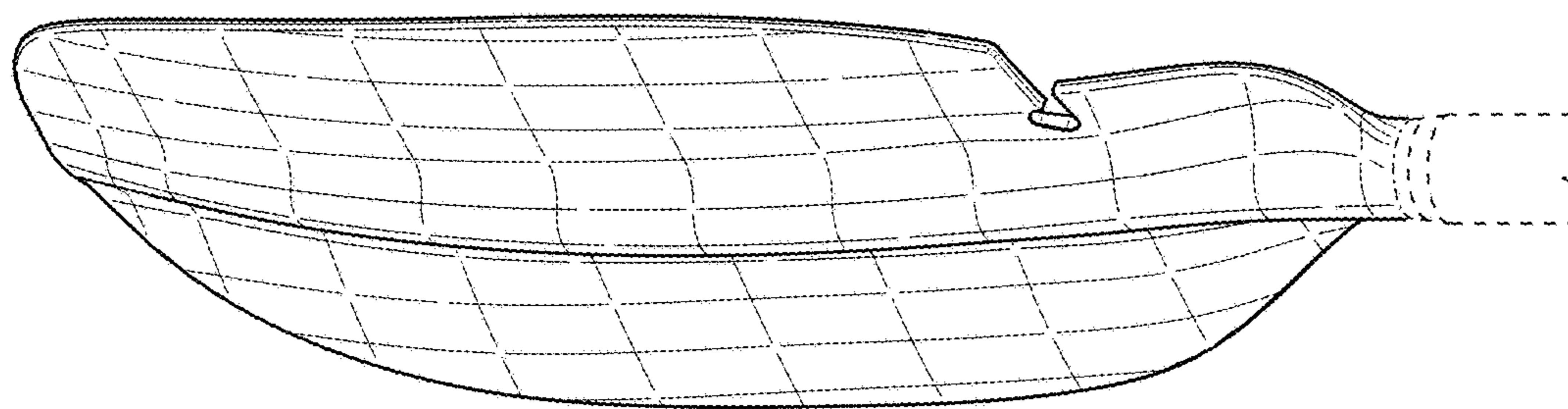

*FIG. 1*

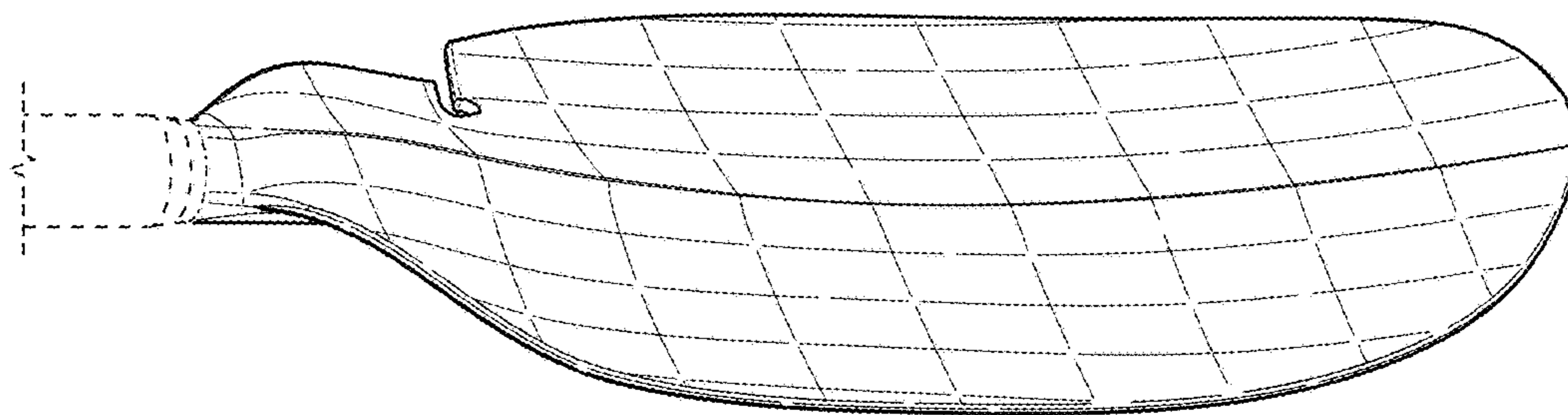

*FIG. 2*

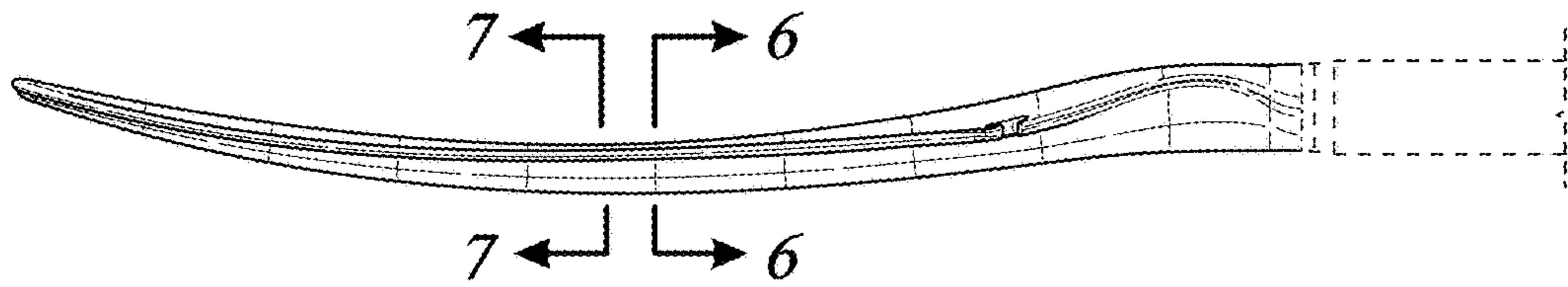

FIG. 3

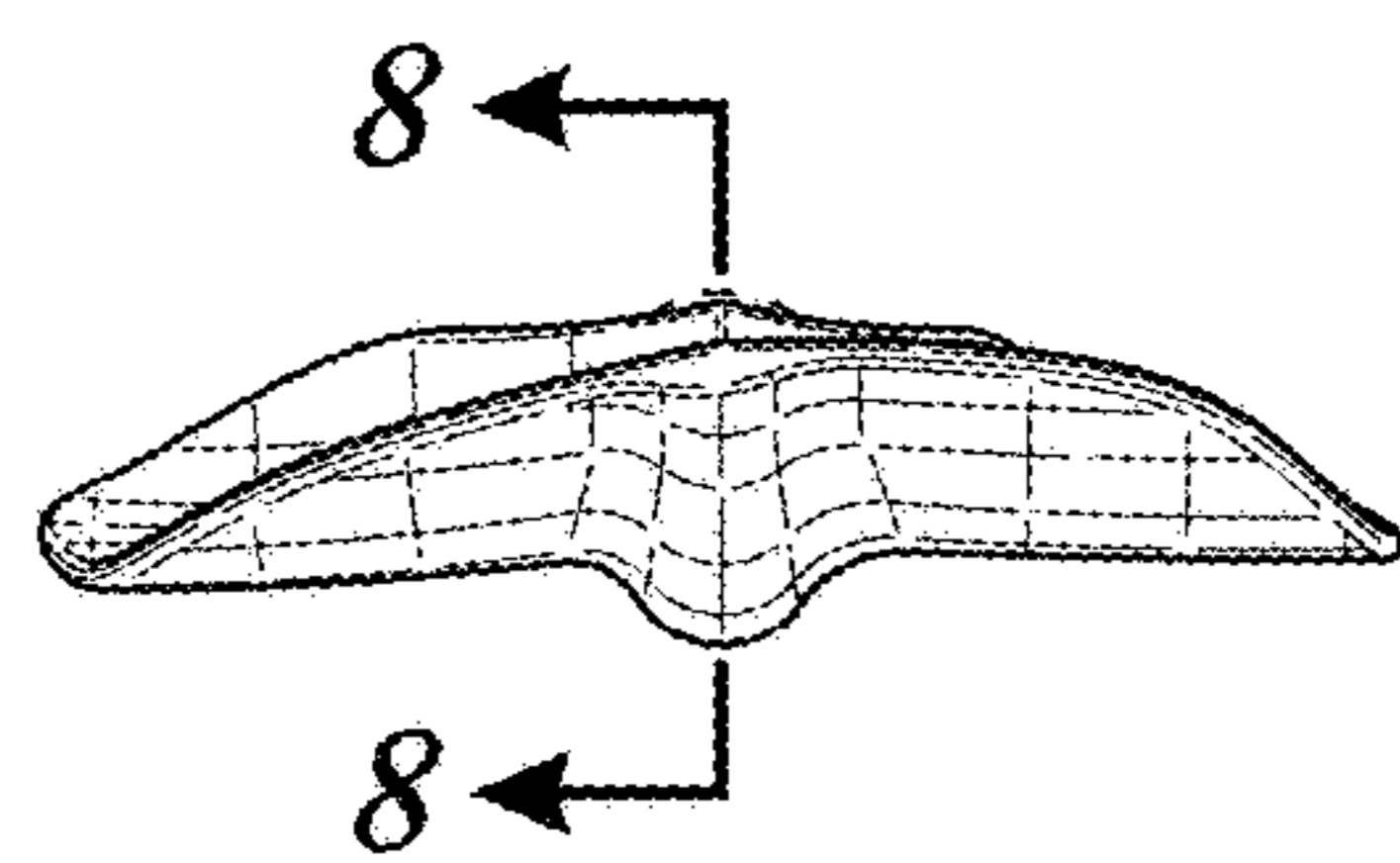

FIG. 4

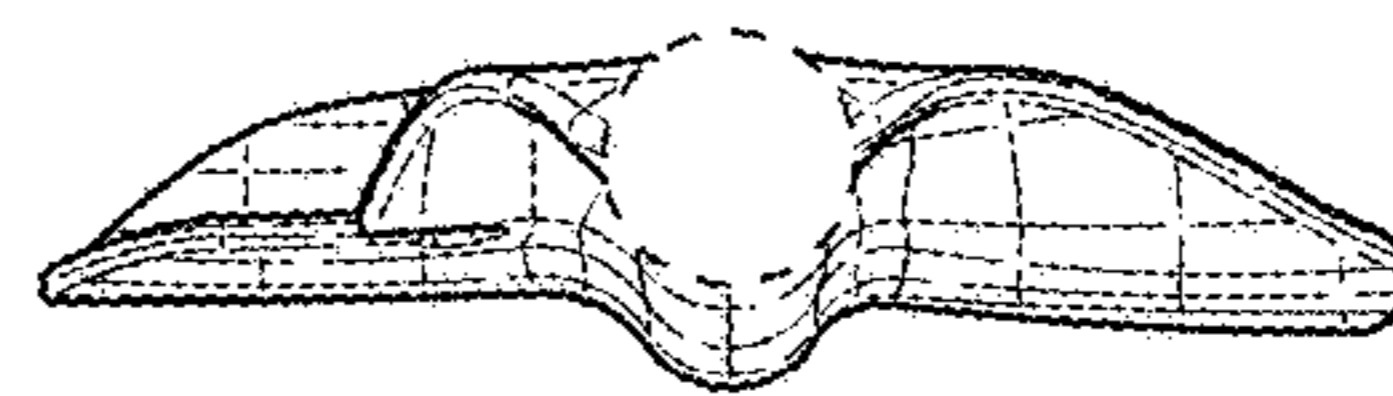

FIG. 5

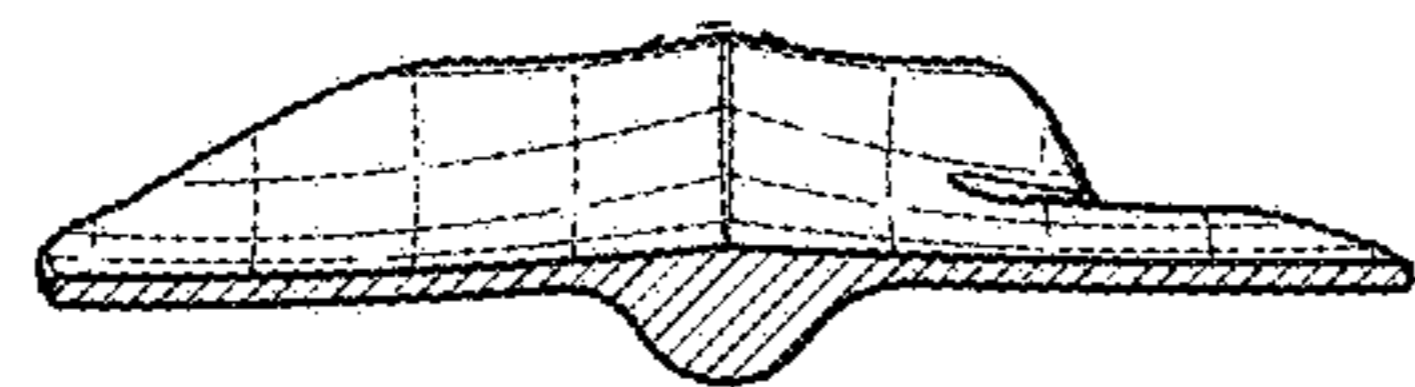

FIG. 6

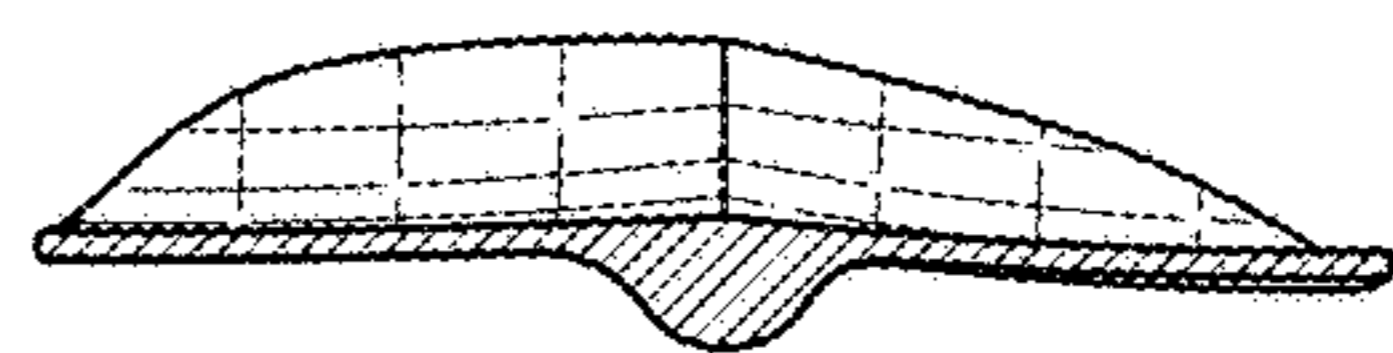

FIG. 7

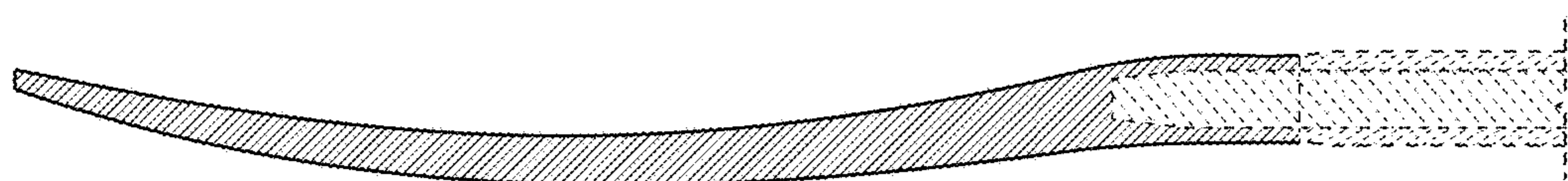
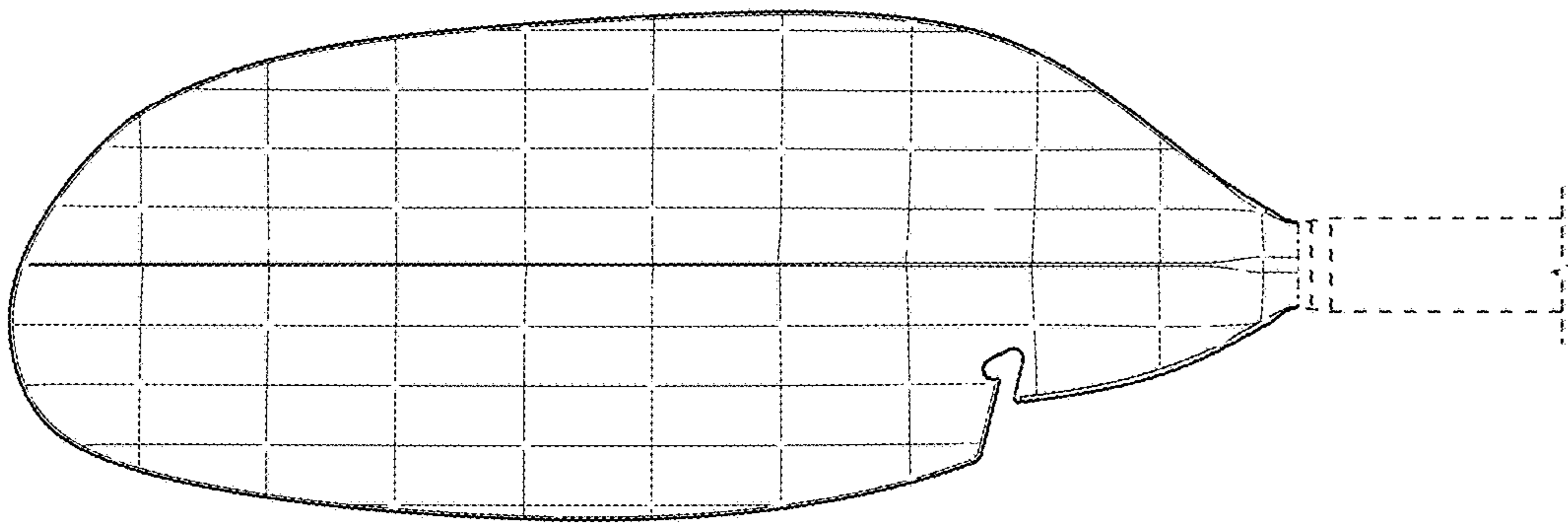

FIG. 8

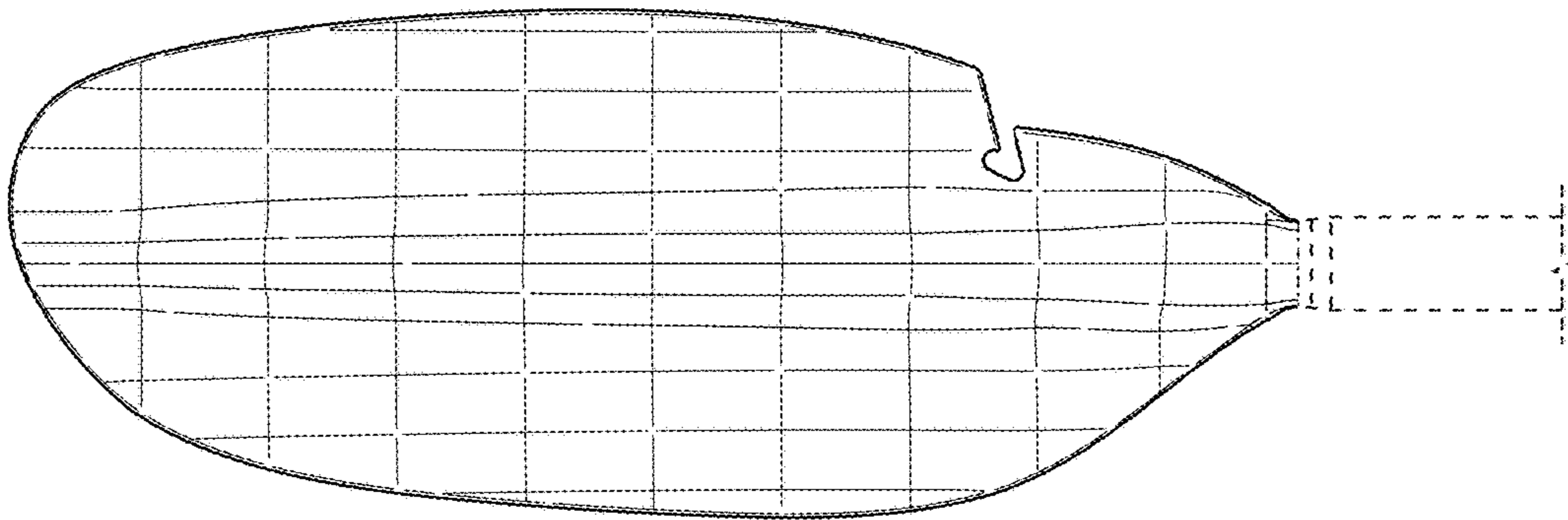

FIG. 9





*FIG. 10*



*FIG. 11*