

US00D869297S

(12) **United States Design Patent**  
**Mane et al.**

(10) **Patent No.:** **US D869,297 S**  
(45) **Date of Patent:** **\*\* Dec. 10, 2019**

(54) **PLANT SENSOR SYSTEM**

- (71) Applicant: **OMS Investments, Inc.**, Los Angeles, CA (US)
- (72) Inventors: **Mercedes Mane**, Mahomet, IL (US);  
**Dyson Singer**, Urbana, IL (US);  
**Kannan Puthuval**, Urbana, IL (US)
- (73) Assignee: **OMS Investments, Inc.**, Los Angeles, CA (US)
- (\*\*) Term: **15 Years**
- (21) Appl. No.: **29/660,754**
- (22) Filed: **Aug. 22, 2018**

**Related U.S. Application Data**

- (63) Continuation of application No. 29/583,418, filed on Nov. 4, 2016, now Pat. No. Des. 829,574.
- (51) **LOC (12) Cl.** ..... **10-04**
- (52) **U.S. Cl.**  
USPC ..... **D10/56**
- (58) **Field of Classification Search**  
USPC ..... D10/46, 56

(Continued)

(56) **References Cited**

**U.S. PATENT DOCUMENTS**

- D688,573 S 8/2013 Behrmann
- D725,507 S \* 3/2015 Marquez ..... D10/56
- D796,354 S \* 9/2017 Chan ..... D10/56

**OTHER PUBLICATIONS**

“New PlantLink devices announced”, The WiFi Garden, Mar. 17, 2016, <http://thewifigarden.com/new-plantlink-announced>, accessed on Jan. 28, 2019.

\* cited by examiner

*Primary Examiner* — Antoine Duval Davis

(74) *Attorney, Agent, or Firm* — Ulmer & Berne LLP

(57) **CLAIM**

The ornamental design for a plant sensor system, as shown and described.

**DESCRIPTION**

- FIG. 1 Is an environmental view of the claimed design.
- FIG. 2 Is a perspective view of the claimed design of FIG. 1.
- FIG. 3 Is a front planar view of the claimed design of FIG. 1.
- FIG. 4 Is a back planar view of the claimed design of FIG. 1.
- FIG. 5 Is a left side planar view of the claimed design of FIG. 1.
- FIG. 6 Is a right side planar view of the claimed design of FIG. 1.
- FIG. 7 Is a top planar view of the claimed design of FIG. 1.
- FIG. 8 Is a bottom planar view of the claimed design of FIG. 1.
- FIG. 9 Is an environmental view of the claimed design.
- FIG. 10 Is a perspective view of the claimed design of FIG. 9.
- FIG. 11 Is a front planar view of the claimed design of FIG. 9.
- FIG. 12 Is a back planar view of the claimed design of FIG. 9.
- FIG. 13 Is a left side planar view of the claimed design of FIG. 9.
- FIG. 14 Is a right side planar view of the claimed design of FIG. 9.
- FIG. 15 Is a top planar view of the claimed design of FIG. 9; and,
- FIG. 16 Is a bottom planar view of the claimed design of FIG. 9.

The broken-line disclosure shown in the views is understood to represent portions of the article in which the claimed design is embodied, but which form no part of the claimed design.

The text “plantlink” in FIGS. 1-3, 5, and 7 is a registered trademark and forms part of the claimed design, according to a first embodiment, in FIGS. 1-8. The owner of the registered trademark “plantlink” is OMS Investments, Inc.

**1 Claim, 12 Drawing Sheets**

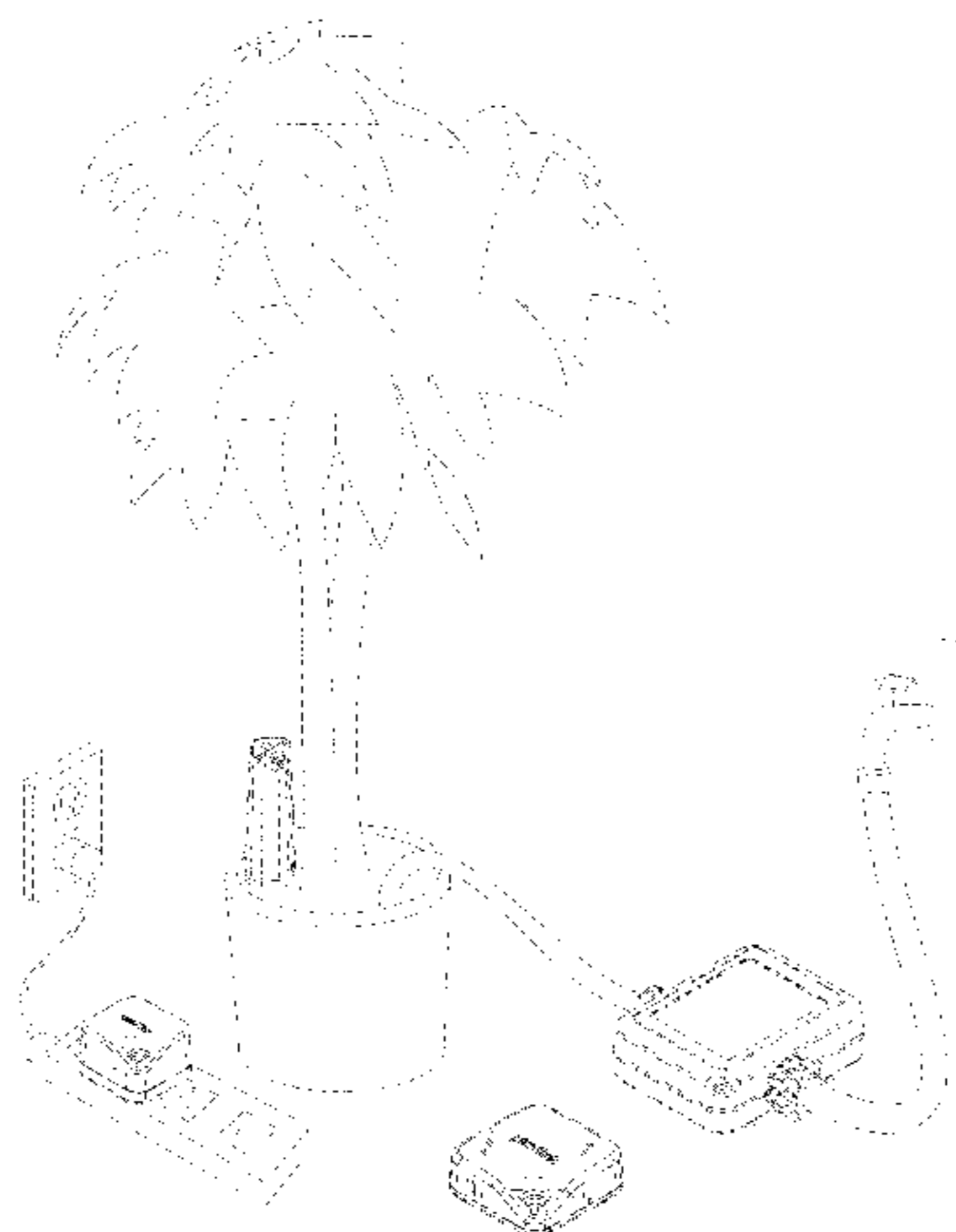

(58) **Field of Classification Search**

CPC ..... A01G 25/16; A01G 25/167; A01G 7/00;  
G01F 23/30; G01F 23/58; G08B 21/00;  
G08B 21/20; G01N 33/246; G01N 33/24;  
G01N 29/036; G01N 2291/0212; G01N  
27/223; G01N 27/041; G01N 27/048;  
G01R 27/2623; G01R 27/20; G01R 27/14

See application file for complete search history.

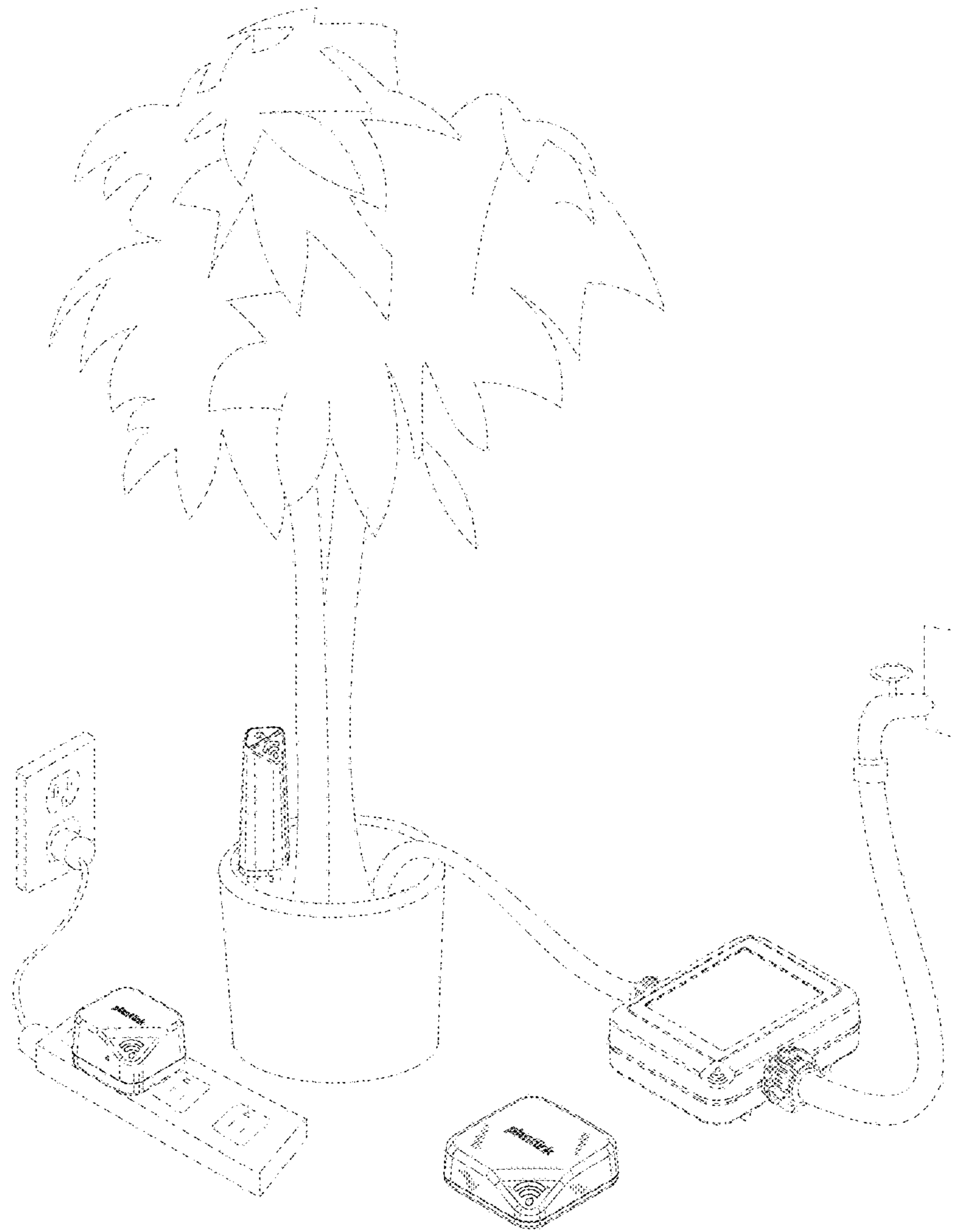

FIG. 1

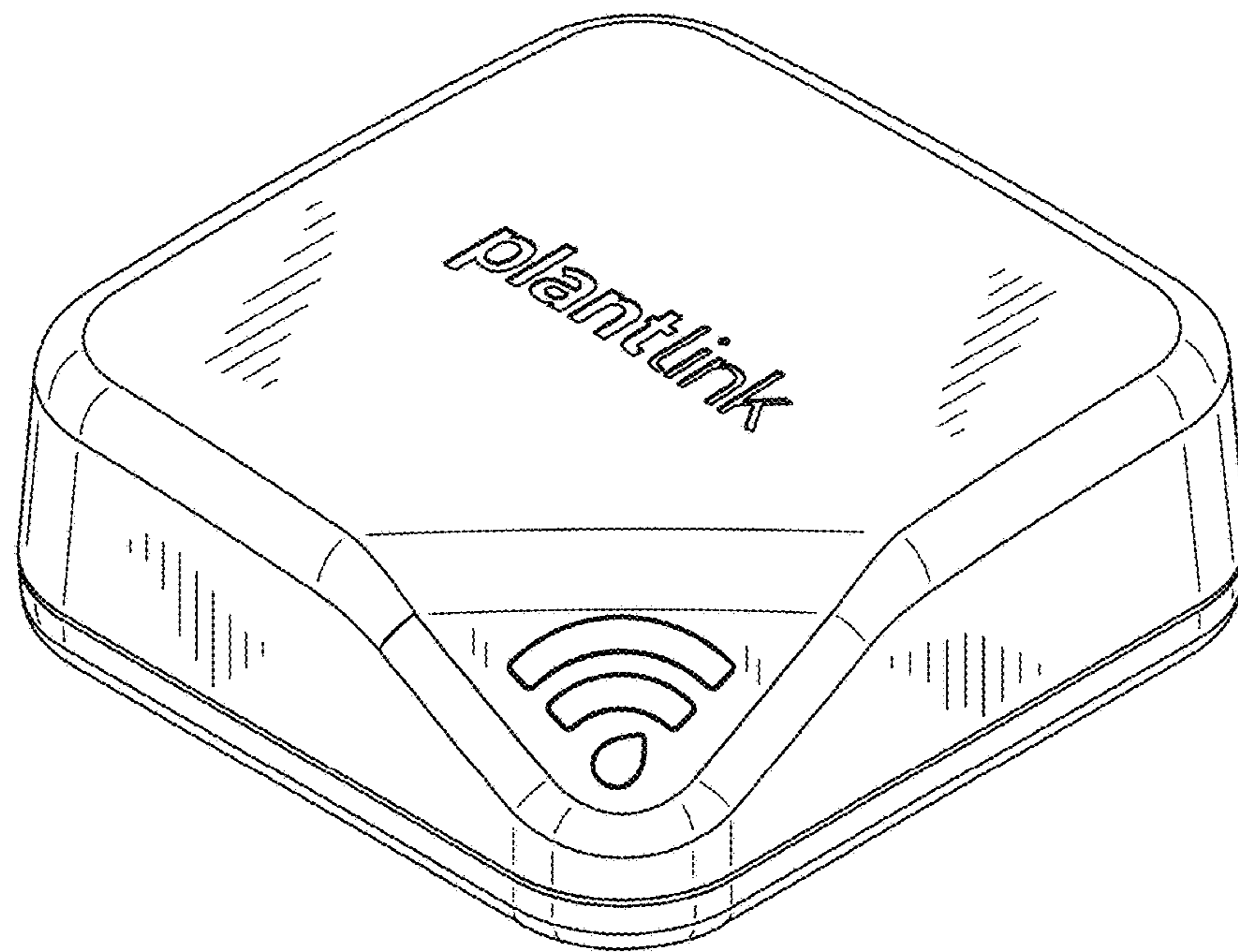

FIG. 2

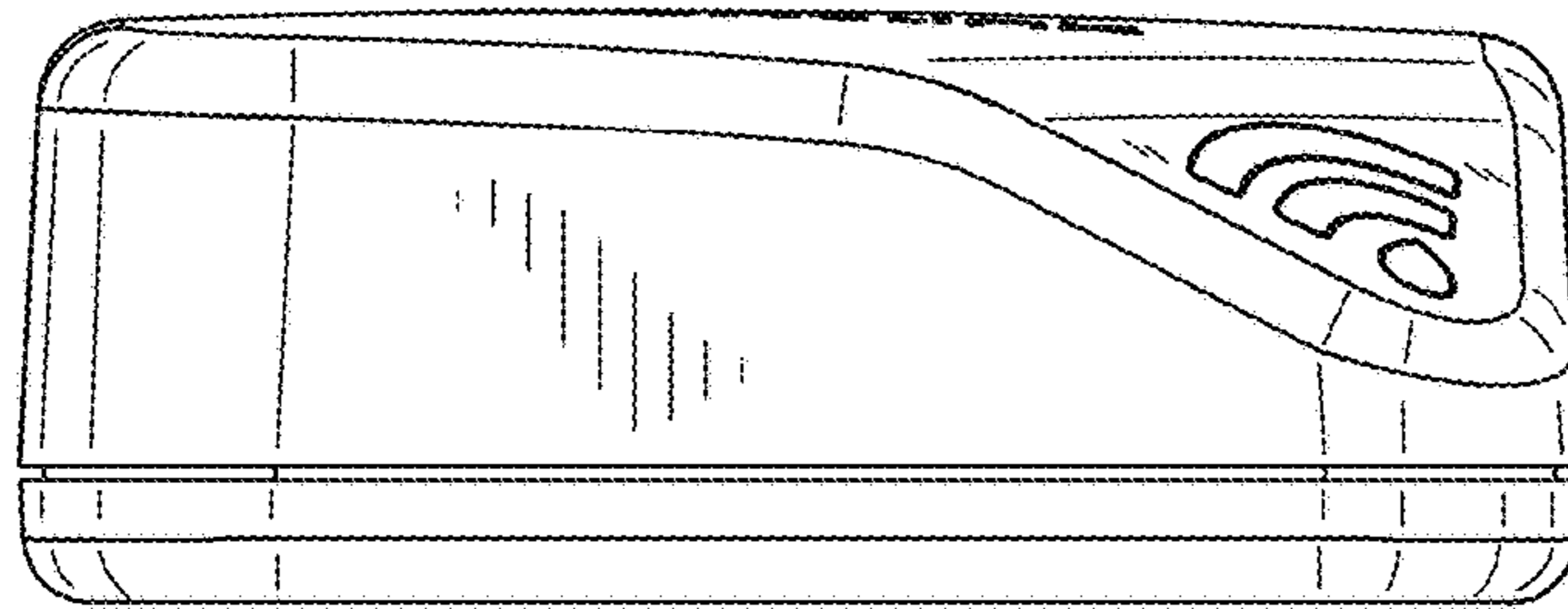

FIG. 3

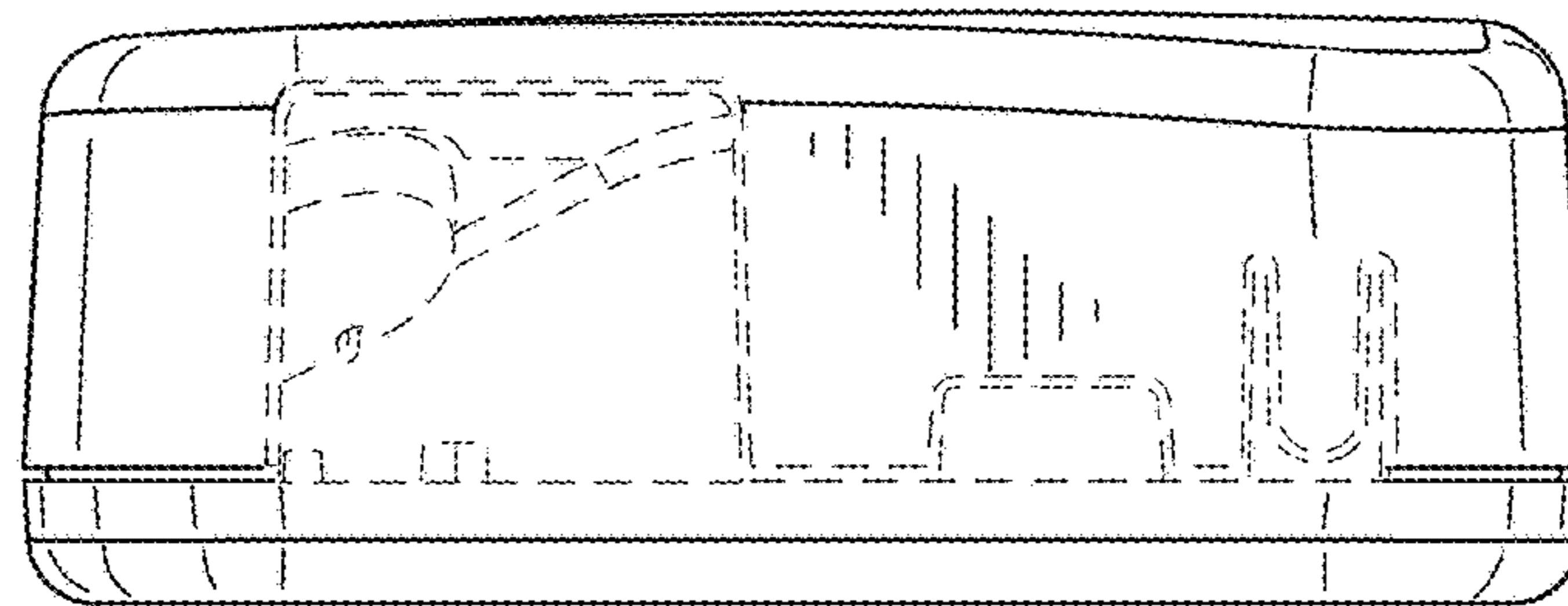

FIG. 4

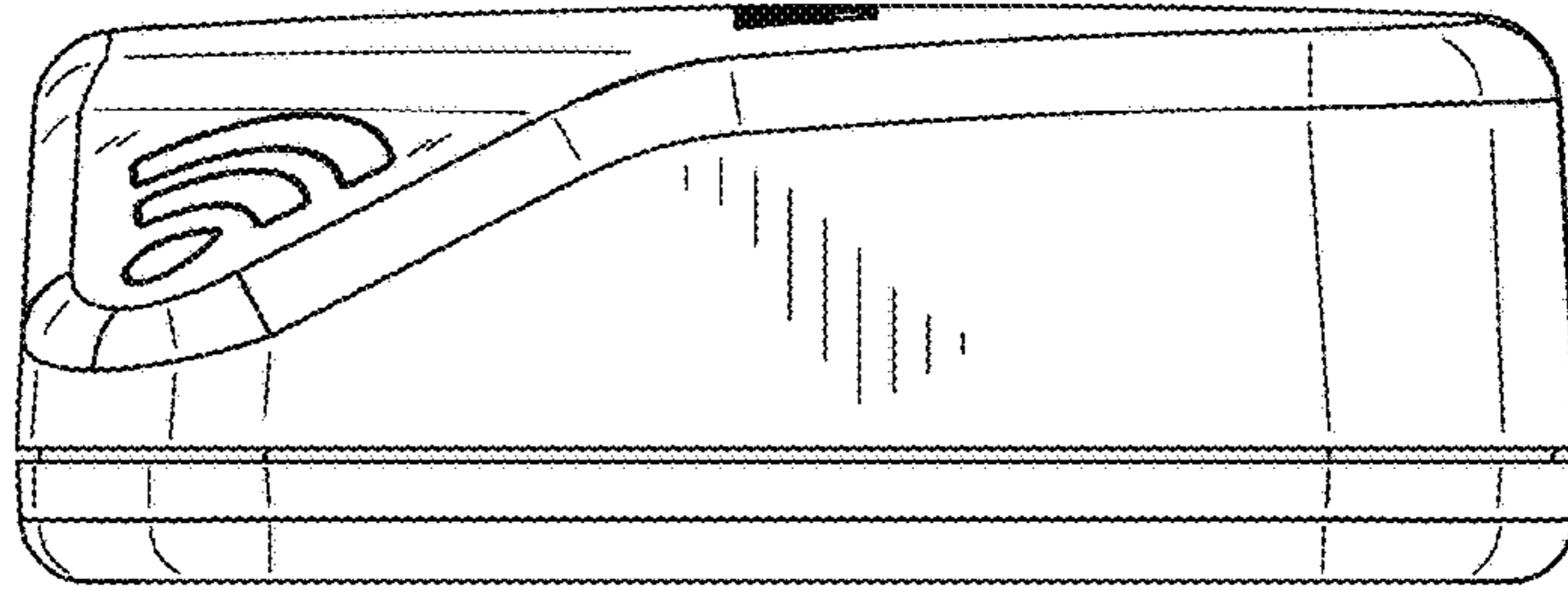

FIG. 5

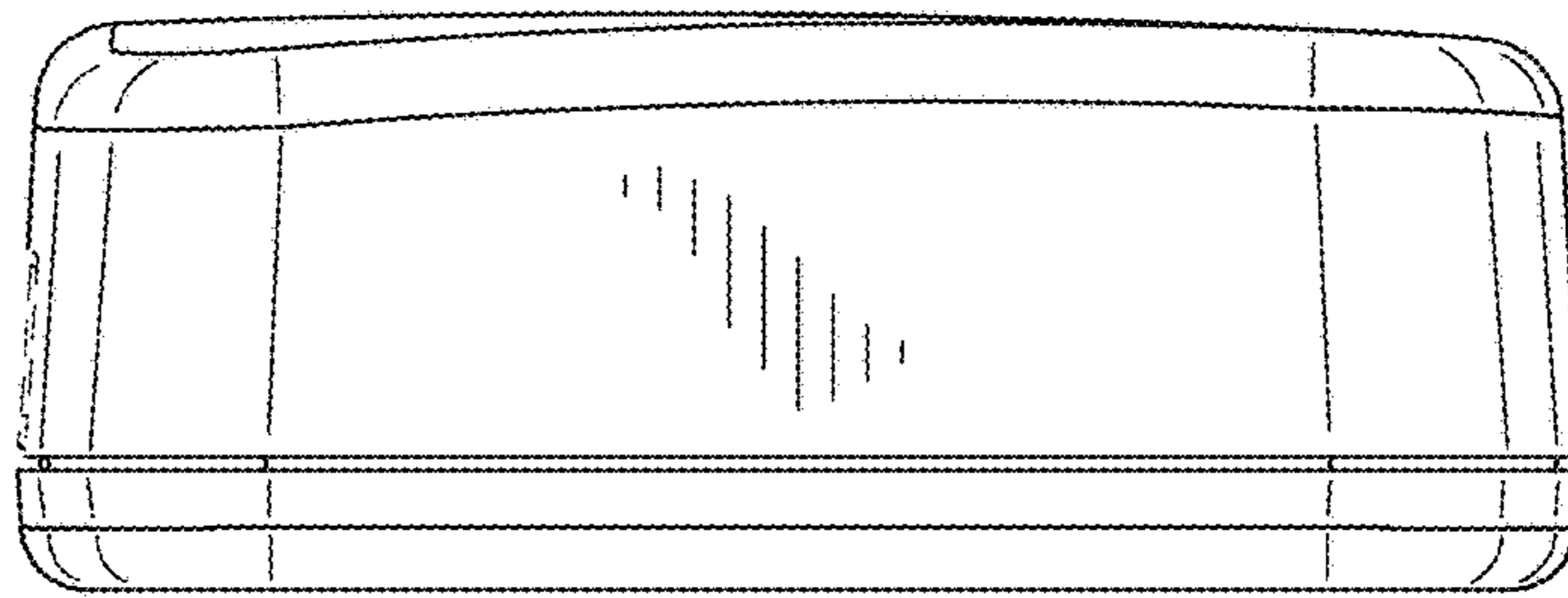

FIG. 6

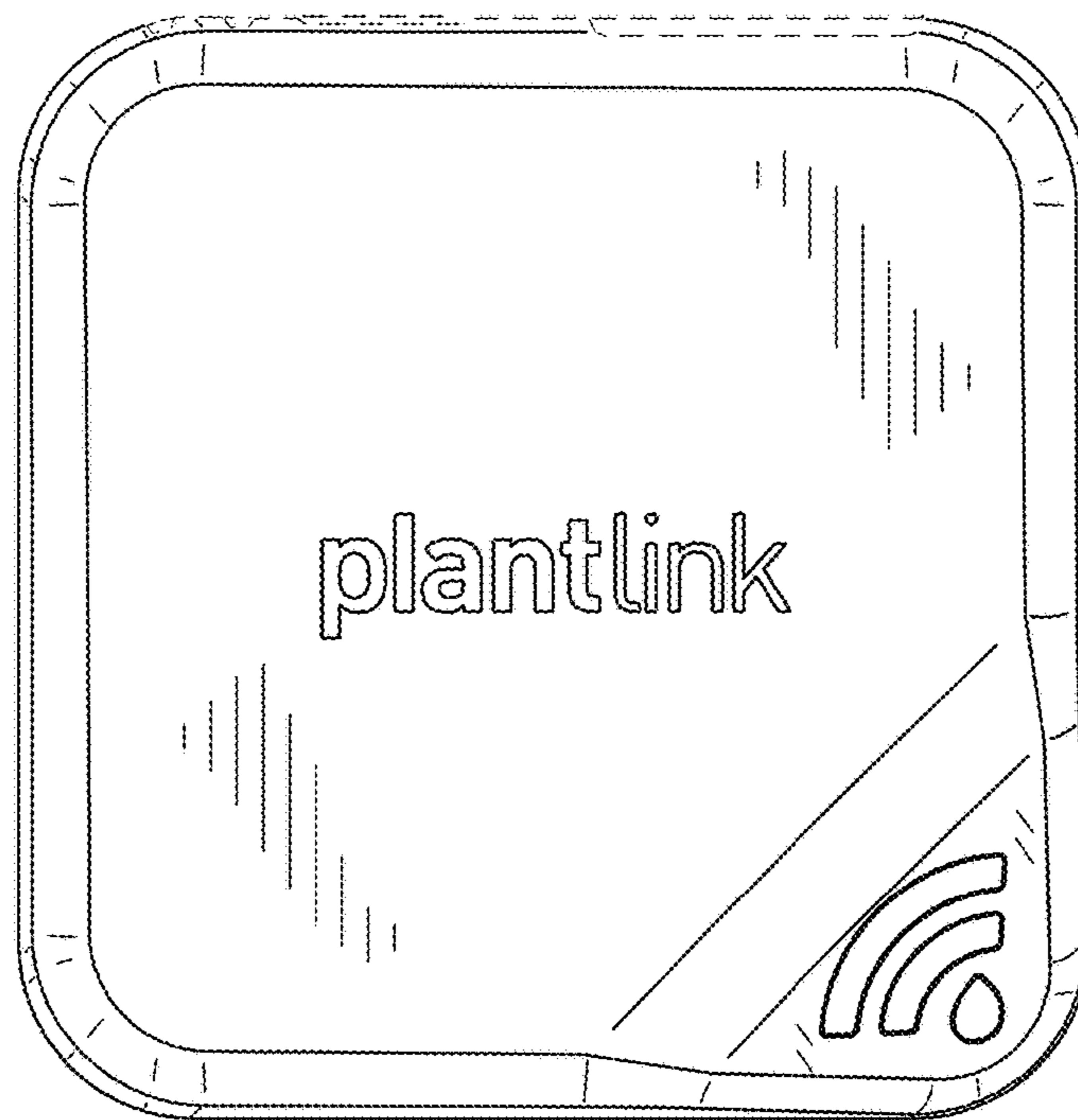

FIG. 7

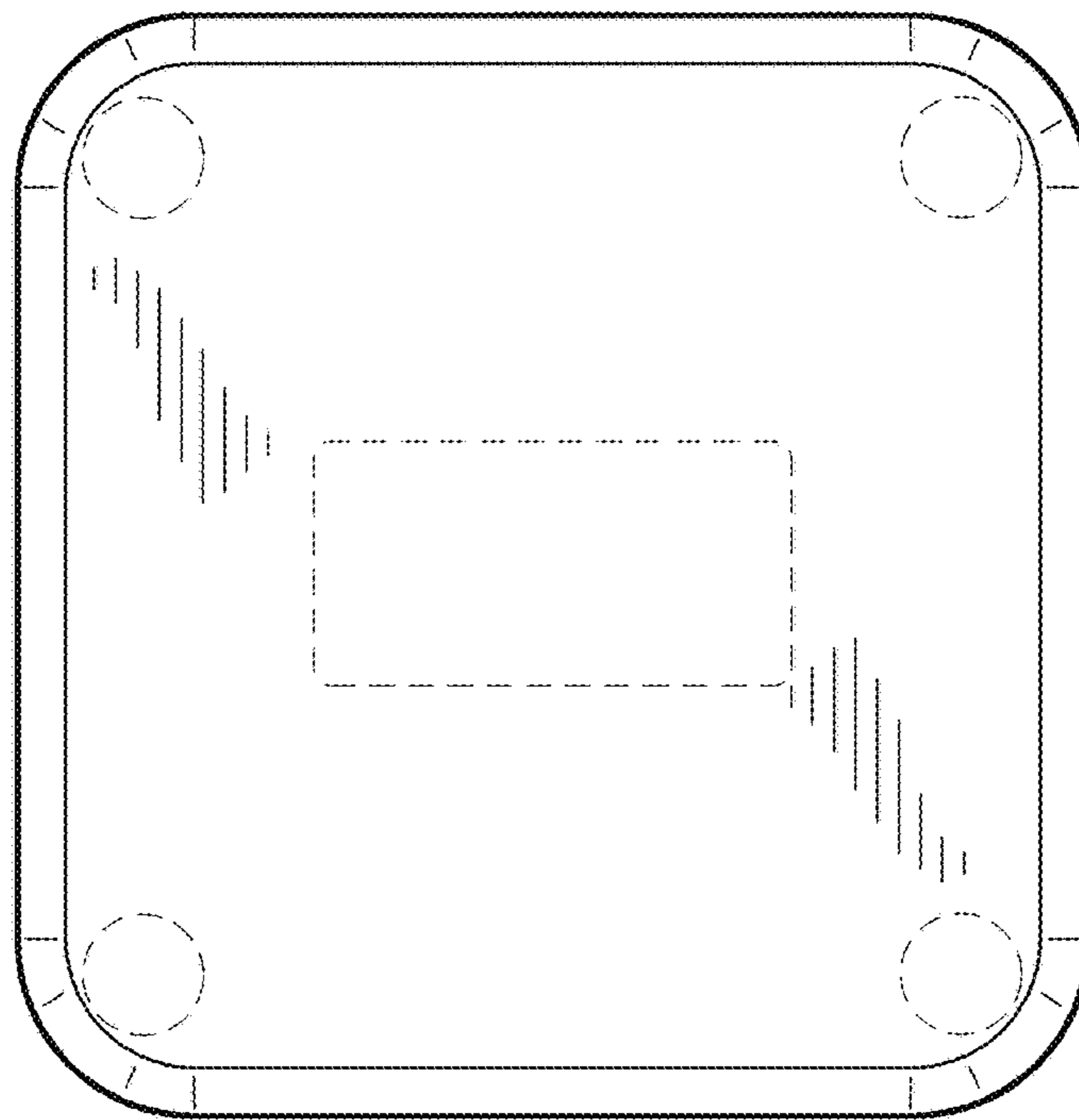

FIG. 8



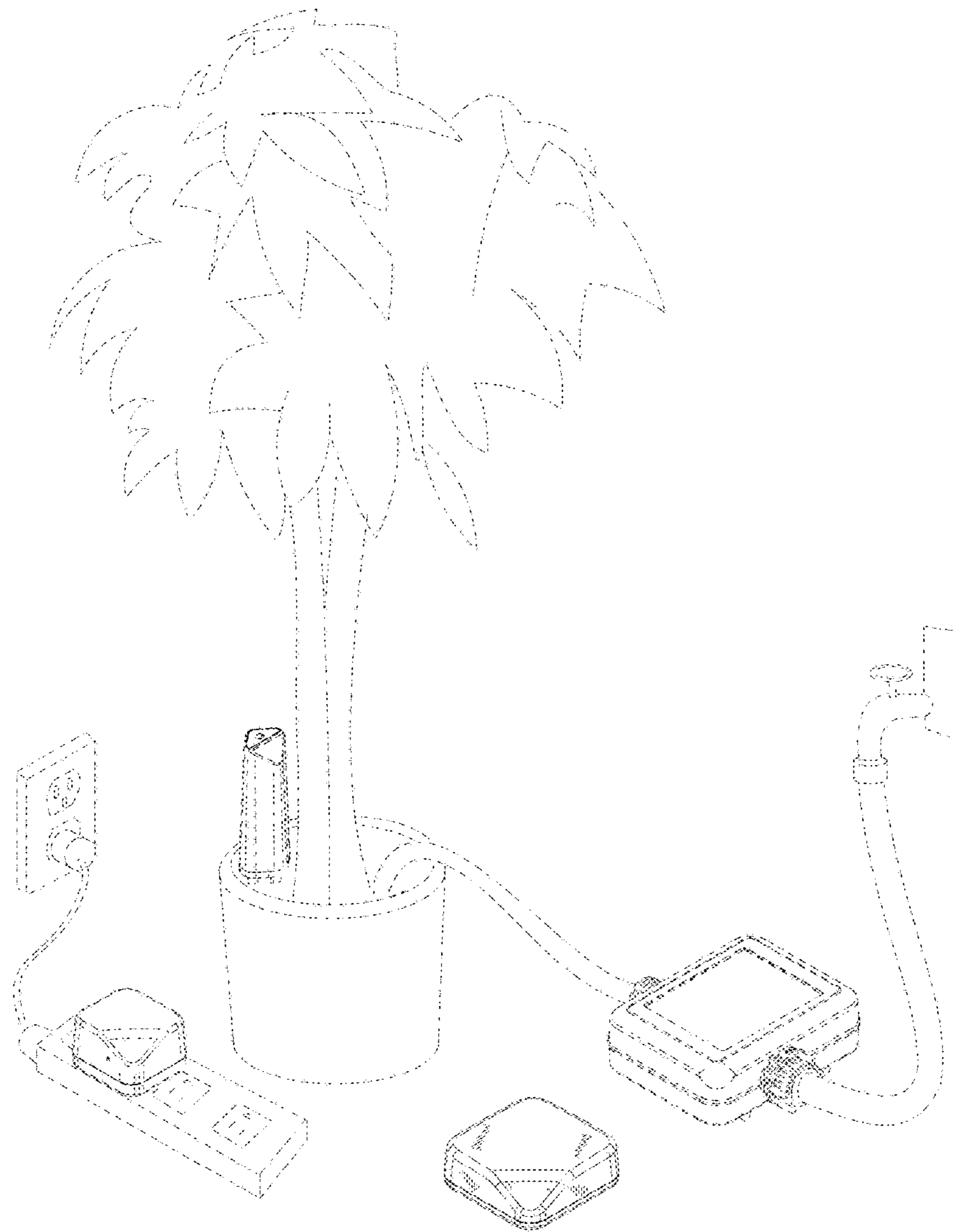

FIG. 9

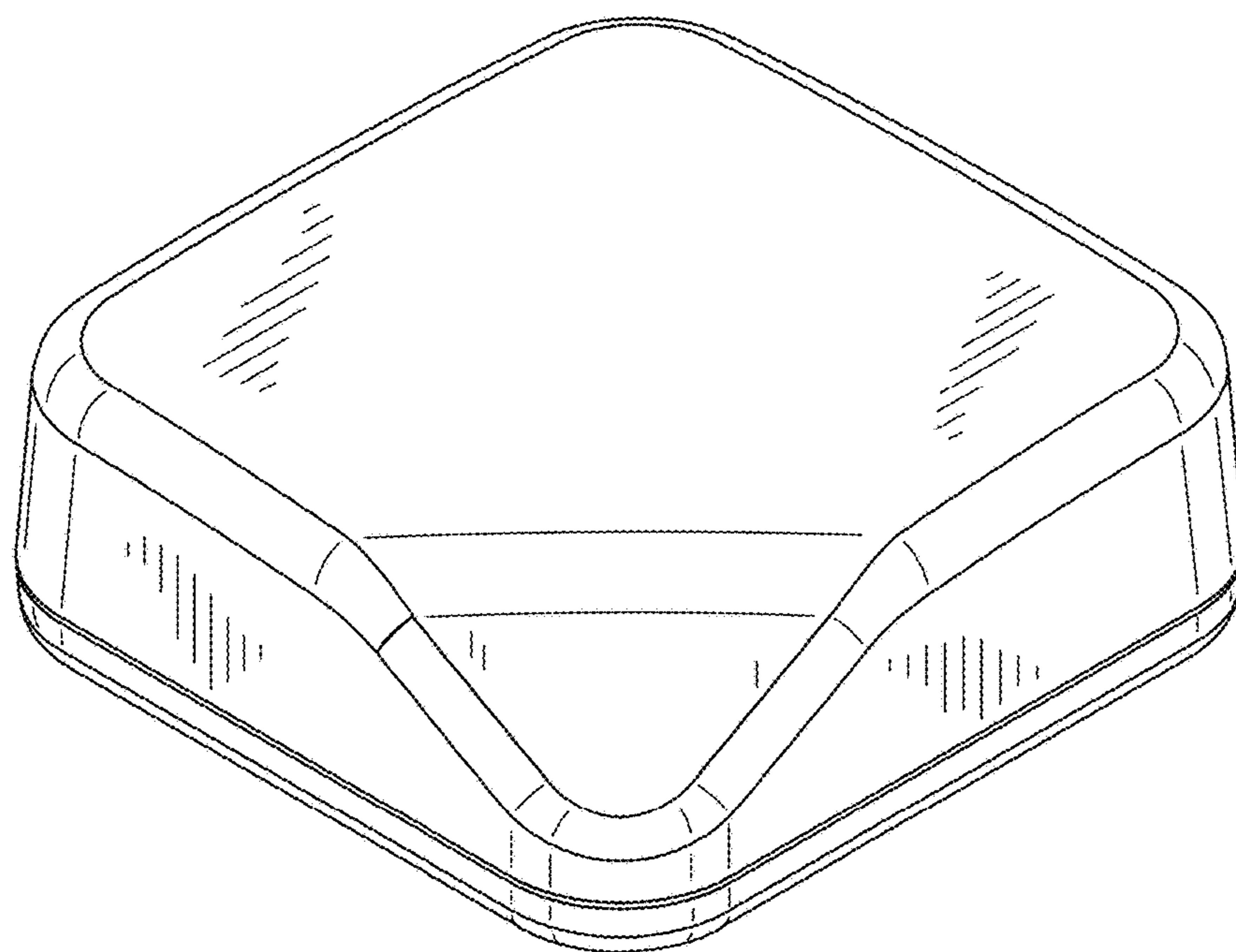

FIG. 10

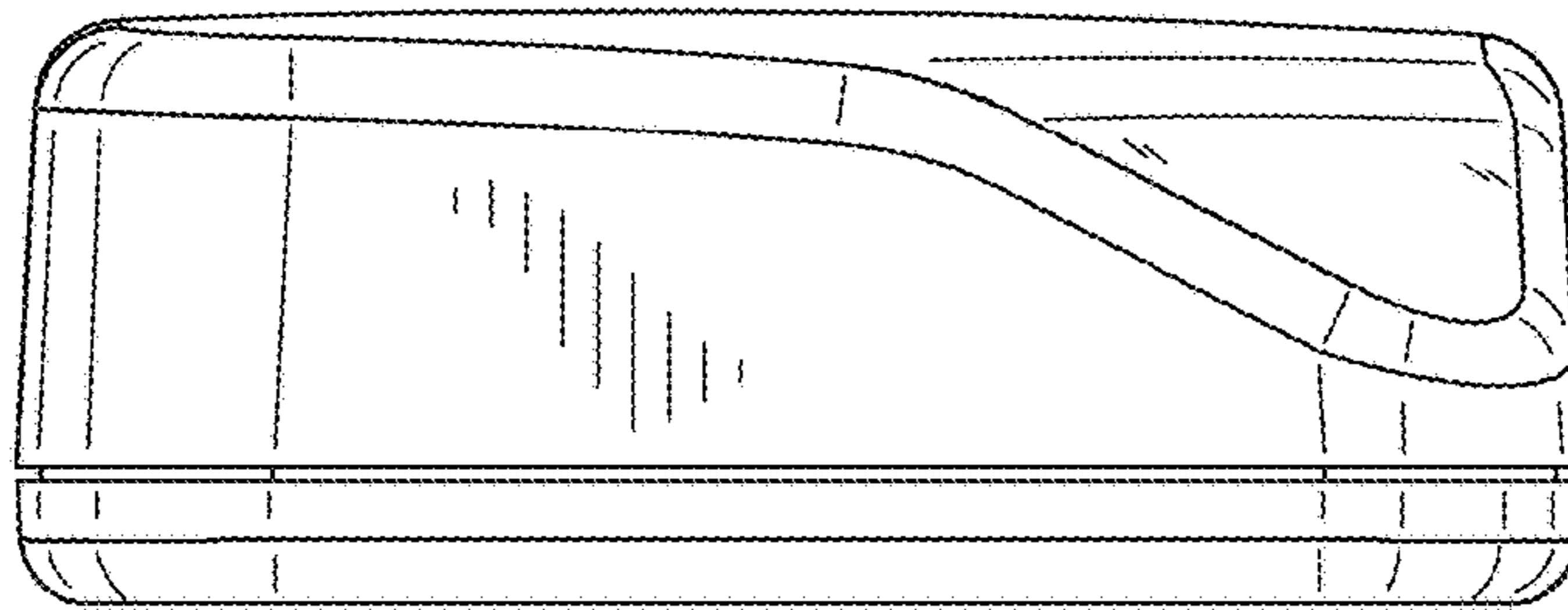

FIG. 11

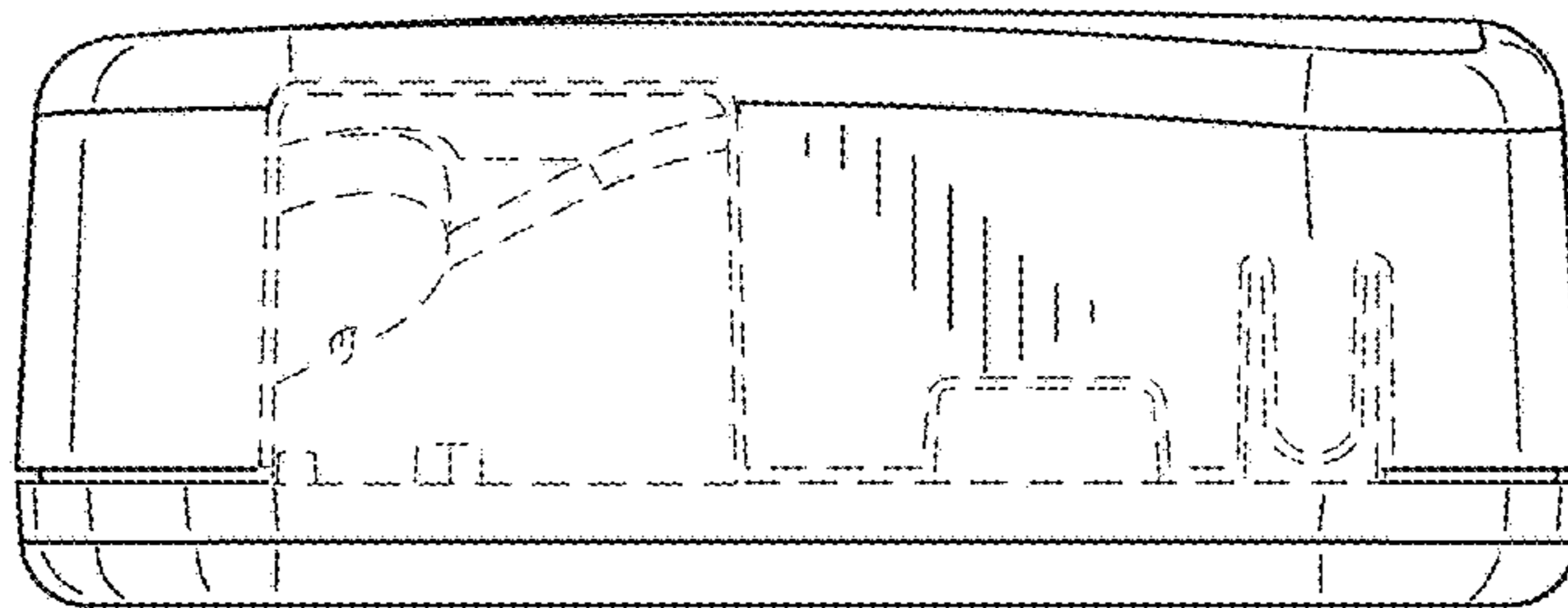

FIG. 12

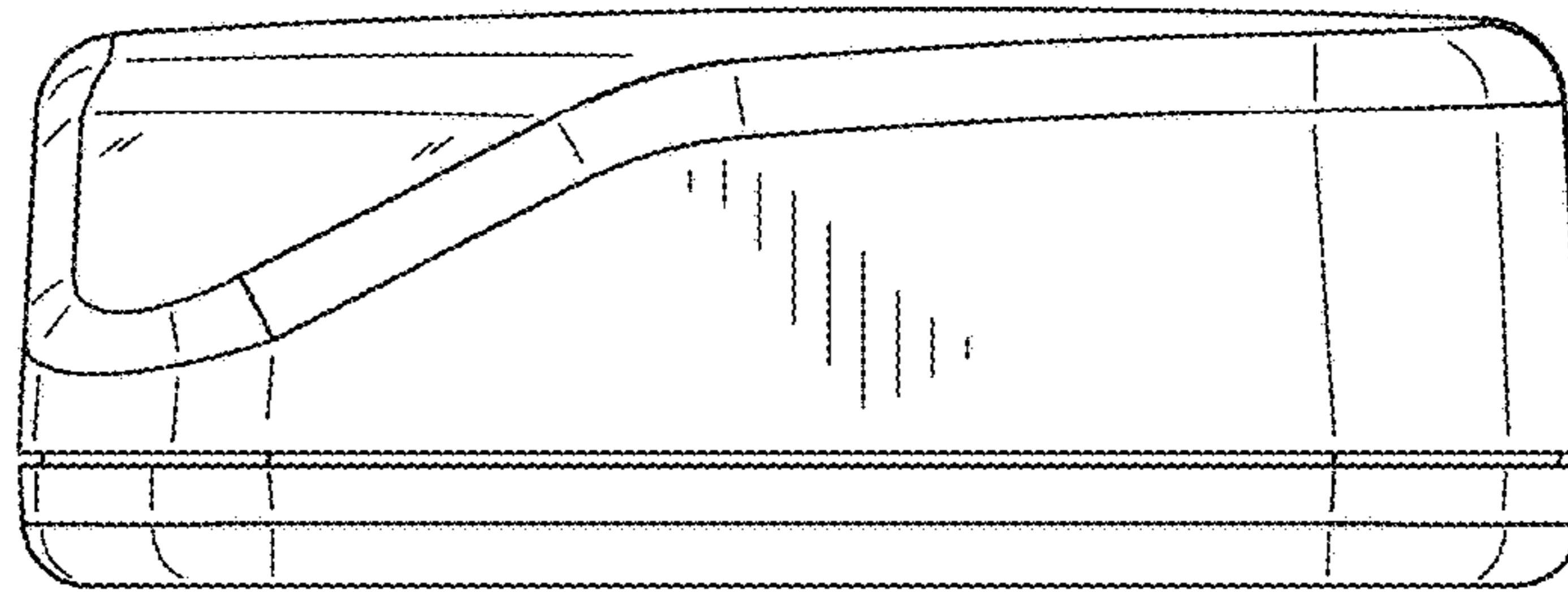

FIG. 13

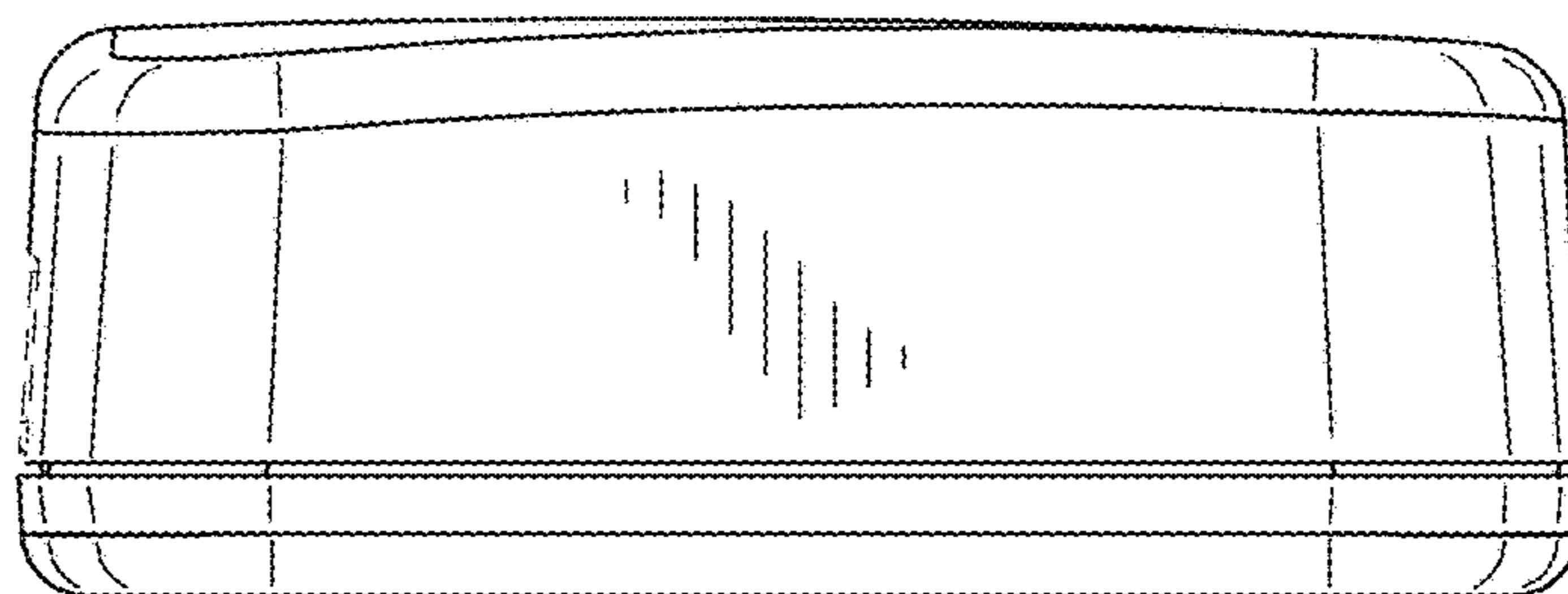

FIG. 14

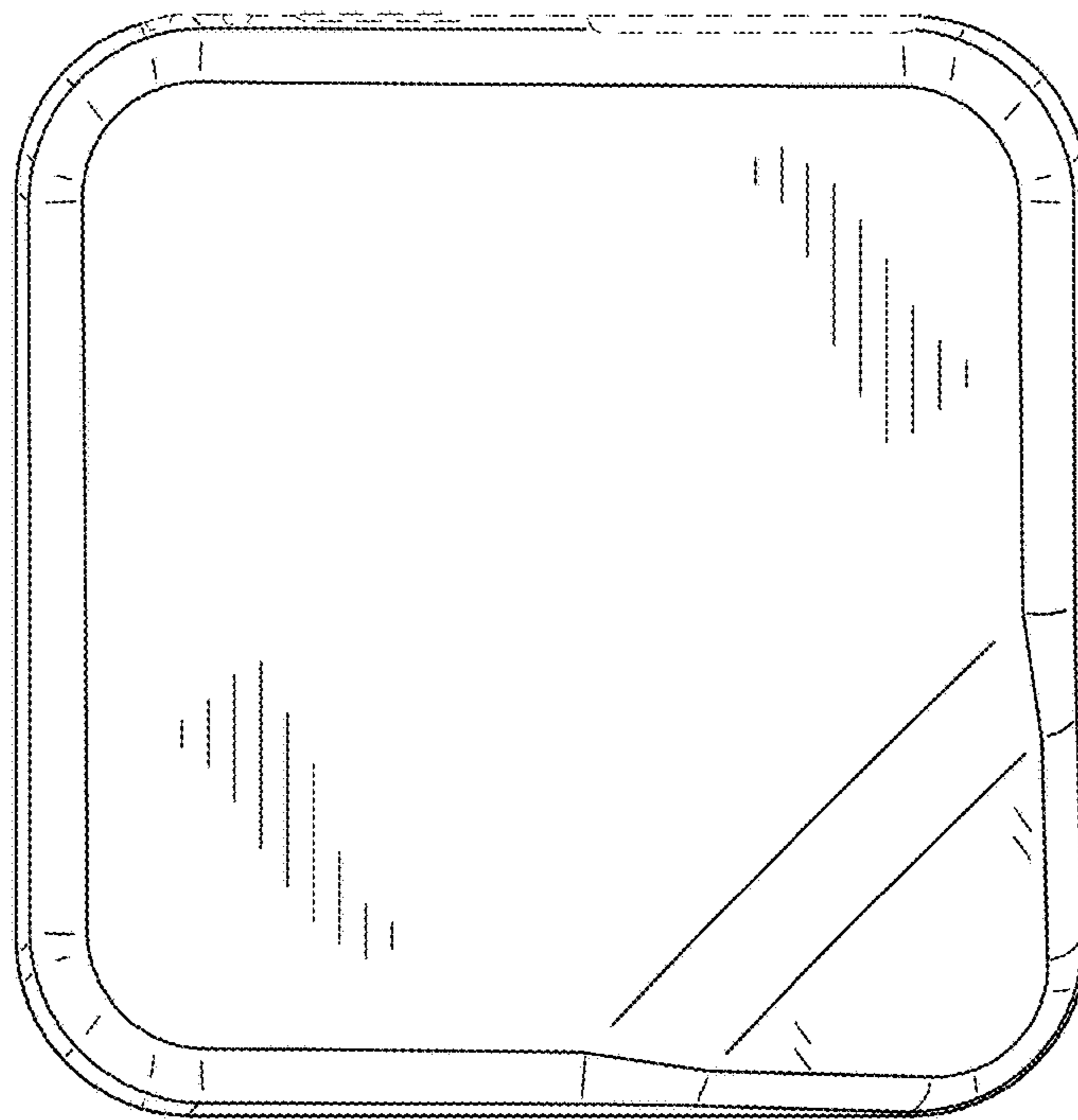

FIG. 15

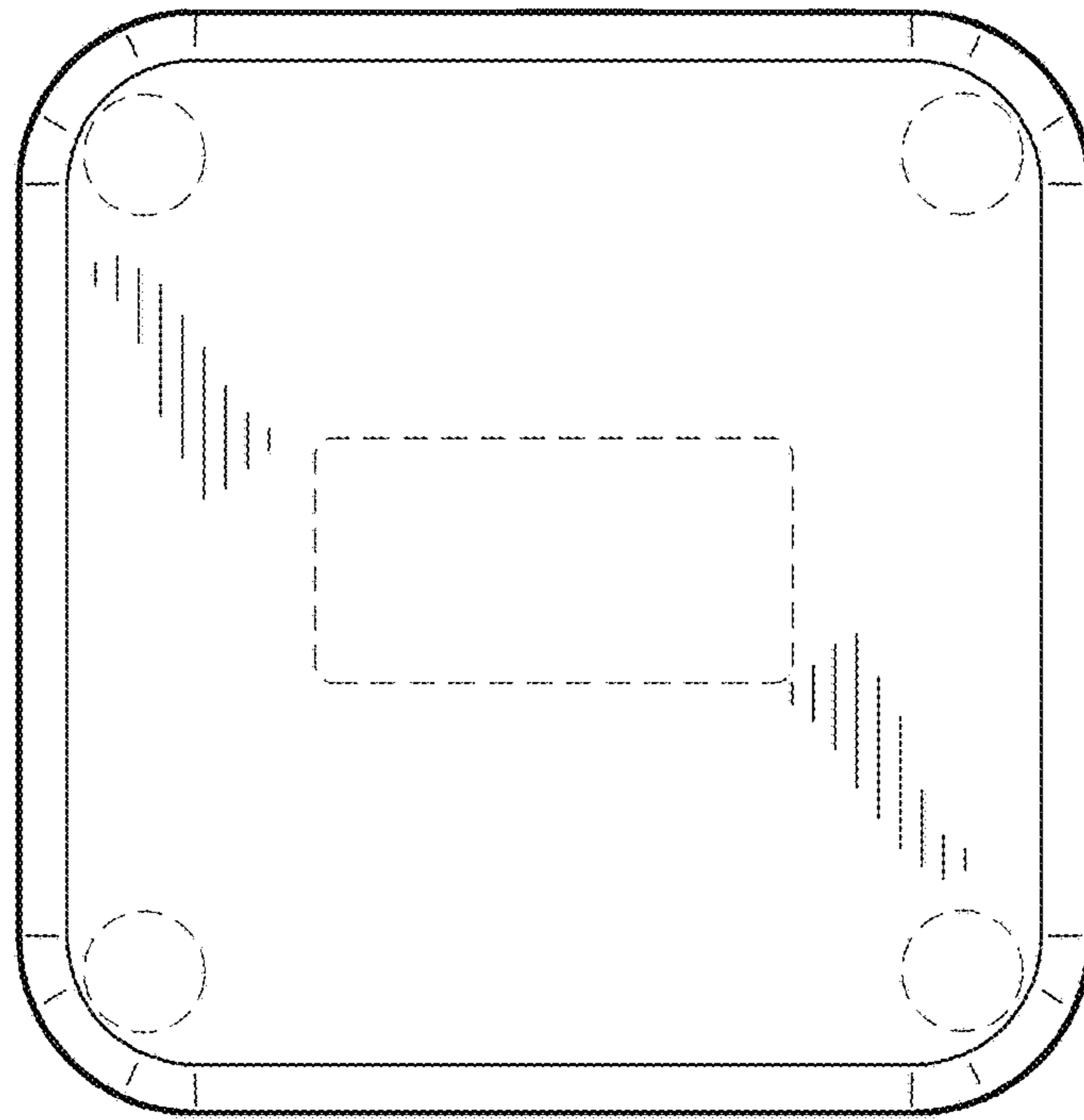

FIG. 16