



US00D869267S

(12) **United States Design Patent**
Ju et al.

(10) **Patent No.:** **US D869,267 S**
(45) **Date of Patent:** **** Dec. 10, 2019**

(54) **KEY DUPLICATOR**

(71) Applicant: **RED Technology Co., Ltd.**, Daejeon (KR)

(72) Inventors: **Jae Sung Ju**, Daejeon (KR); **Bum Suk Ho**, Daejeon (KR); **Seung Won Kwak**, Daejeon (KR); **In Sik Oh**, Daejeon (KR); **Jeong Wook Choi**, Daejeon (KR); **Il Ho Kim**, Daejeon (KR); **Mi Ri Kwak**, Daejeon (KR); **Tae Ri Kang**, Daejeon (KR); **Dan Bi Kim**, Daejeon (KR)

(**) Term: **15 Years**

(21) Appl. No.: **29/622,218**

(22) Filed: **Oct. 16, 2017**

(51) **LOC (12) Cl.** **08-99**

(52) **U.S. Cl.**
USPC **D8/499**; D15/127

(58) **Field of Classification Search**
USPC D8/499; D14/370, 434-435, 437, 432, D14/356; D13/184; D15/127, 128
CPC B23C 3/28; B23C 3/36; B23C 3/35
See application file for complete search history.

(56) **References Cited**

U.S. PATENT DOCUMENTS

- 5,660,509 A * 8/1997 Cole B23C 3/35
409/137
- D441,379 S * 5/2001 Kanat D15/127
- 6,836,553 B2 * 12/2004 Campbell B23C 3/35
382/100
- 6,839,449 B1 * 1/2005 Campbell B23C 3/35
382/100

- 7,077,607 B2 * 7/2006 Foscan B23B 31/028
279/156
- 9,101,990 B2 * 8/2015 Mutch B23C 3/35
- D787,575 S * 5/2017 Ferretti D15/127
- 2009/0074528 A1 * 3/2009 Hadad B23C 3/35
409/82

* cited by examiner

Primary Examiner — Janice Hallmark
Assistant Examiner — Harold E Blackwell, II
(74) *Attorney, Agent, or Firm* — Antonio Ha & U.S. Patent, LLC

(57) **CLAIM**

The ornamental design for an key duplicator, as shown and described.

DESCRIPTION

FIG. 1 is a perspective view of the key duplicator of the present invention;
FIG. 2 is a front view of the key duplicator of the present invention;
FIG. 3 is a rear view of the key duplicator of the present invention;
FIG. 4 is a left side view of the key duplicator of the present invention;
FIG. 5 is a right side view of the key duplicator of the present invention;
FIG. 6 is a top view of the key duplicator of the present invention; and,
FIG. 7 is a bottom view of the key duplicator of the present invention.

1 Claim, 7 Drawing Sheets

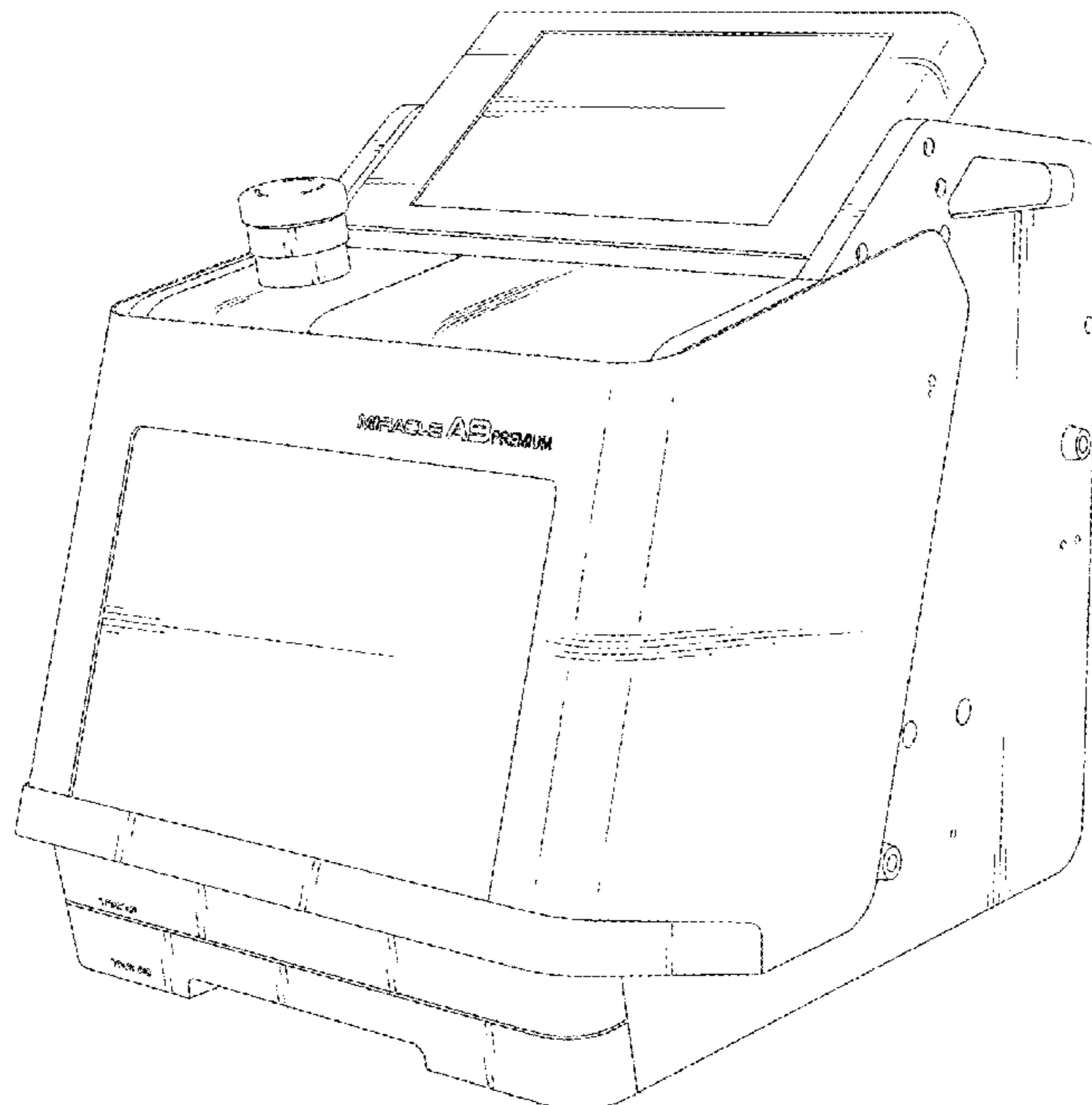

Fig. 1

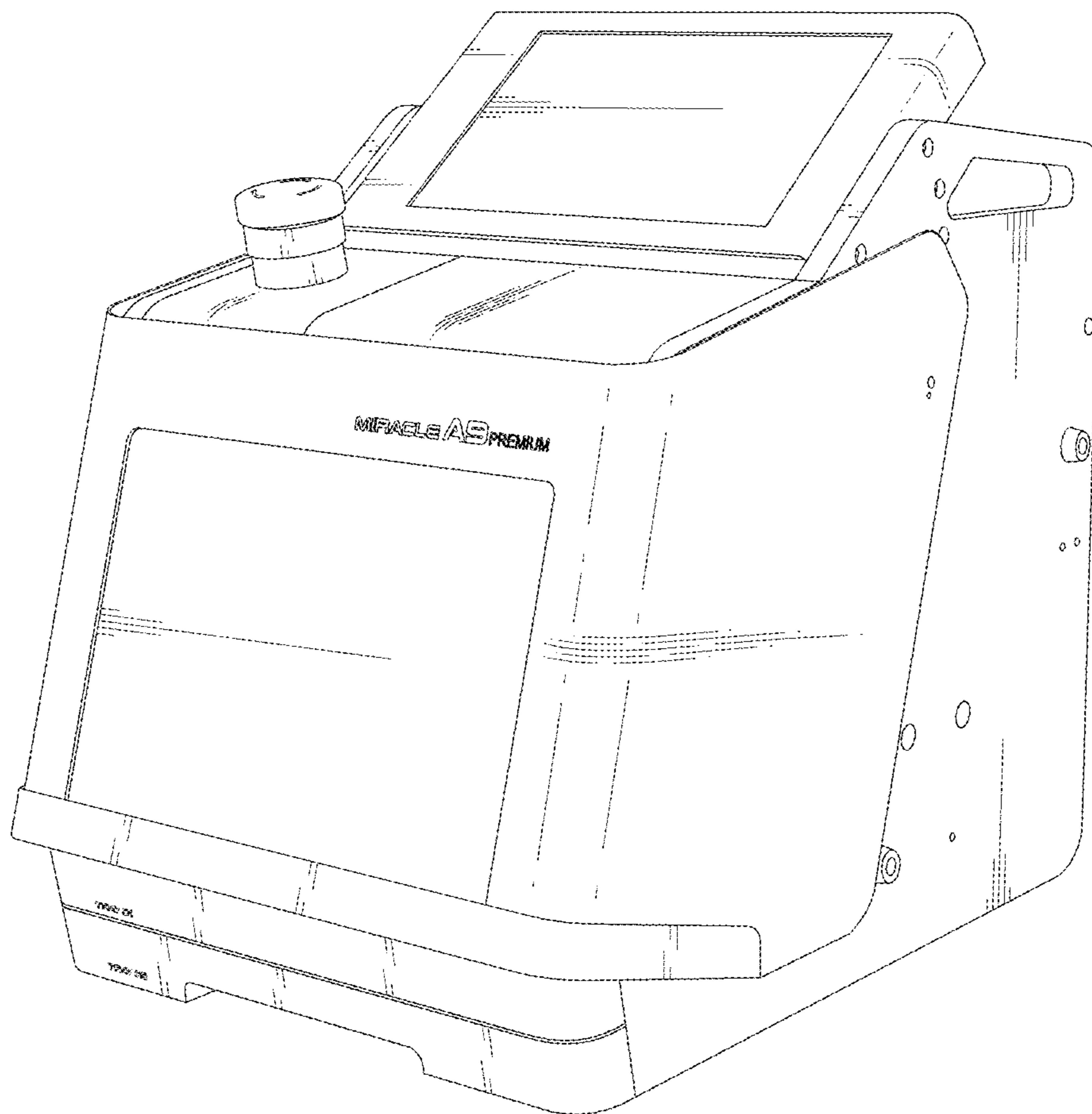

Fig. 2

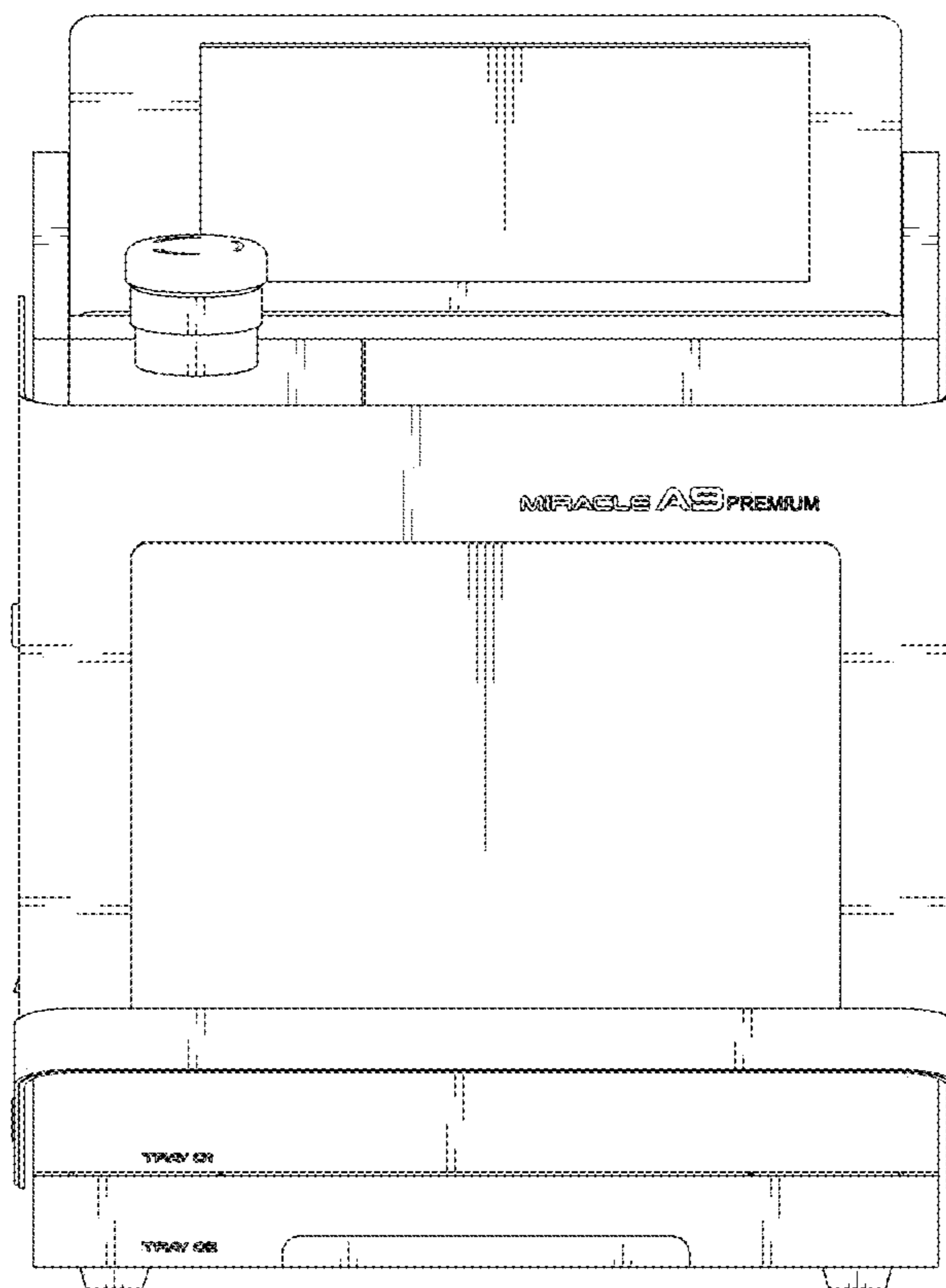

Fig. 3

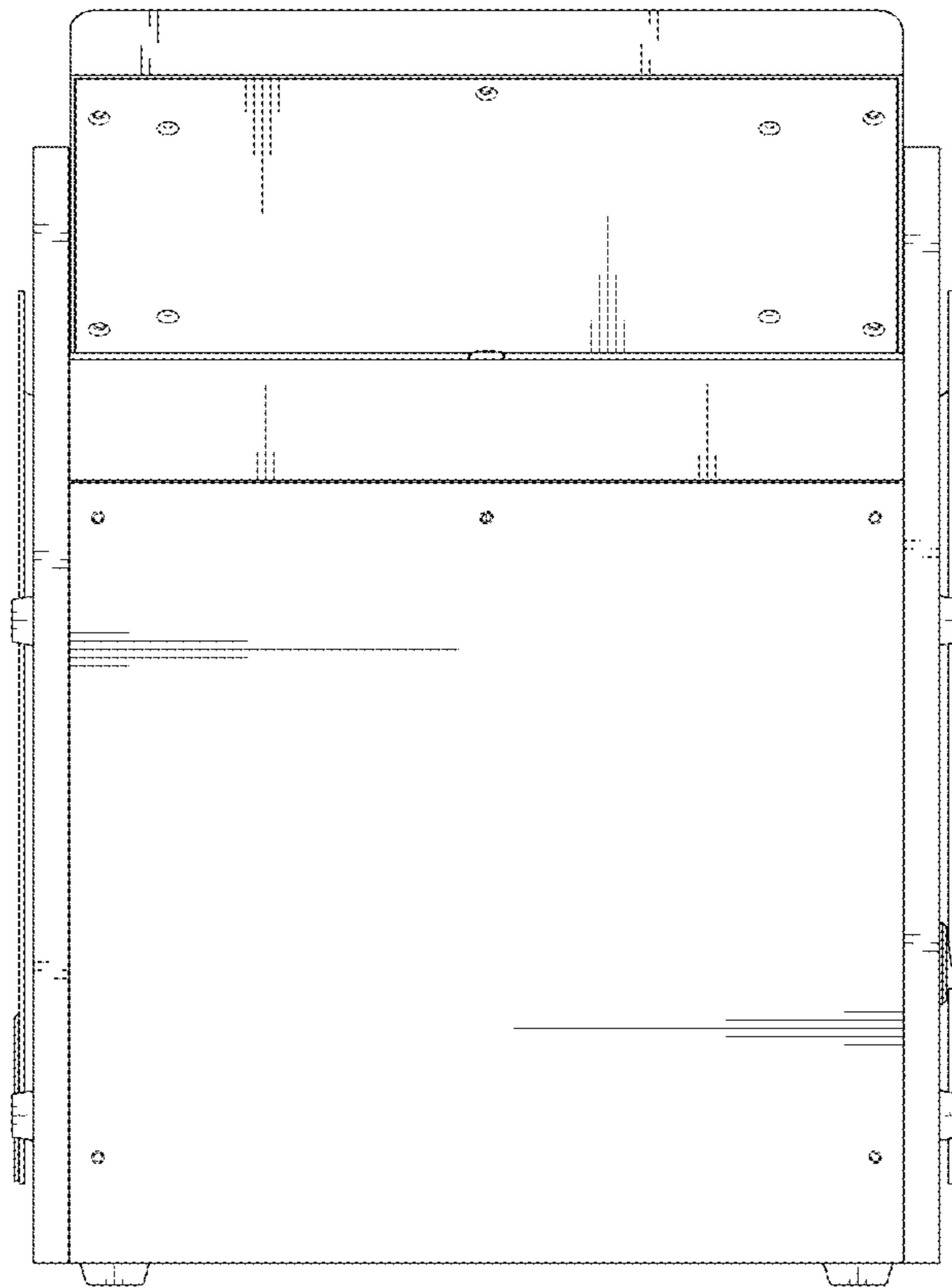

Fig. 4

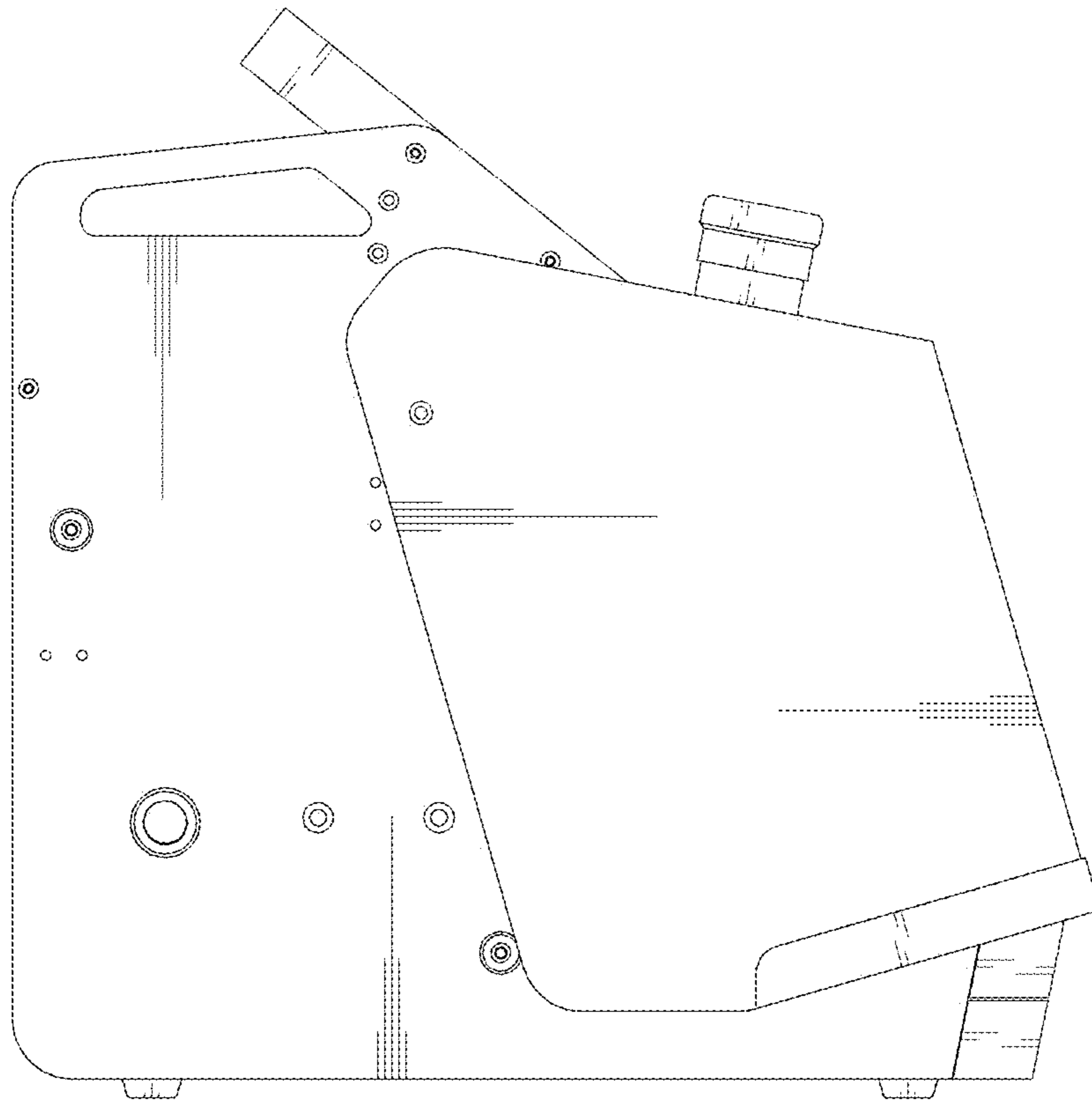

Fig. 5

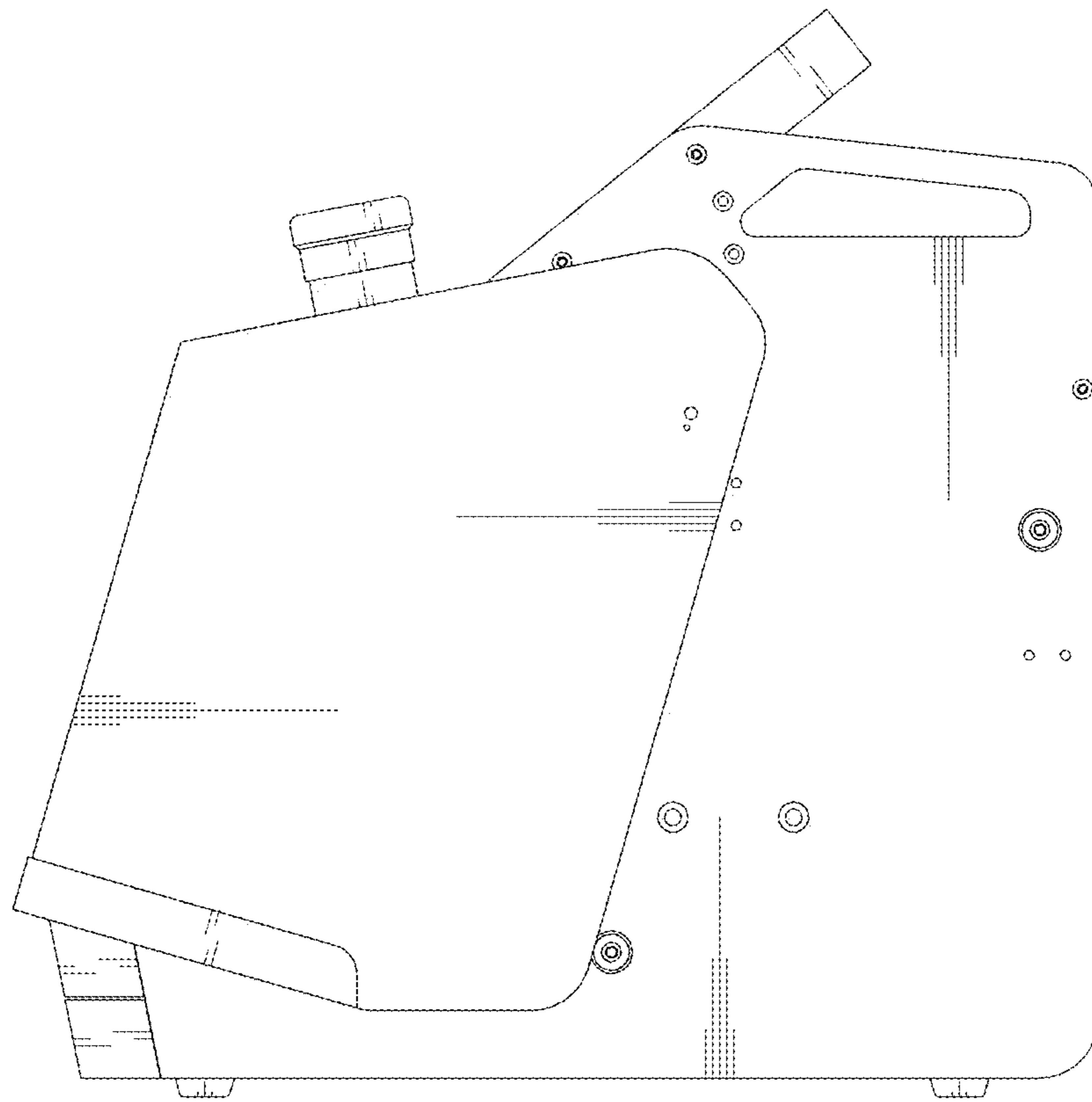

Fig. 6

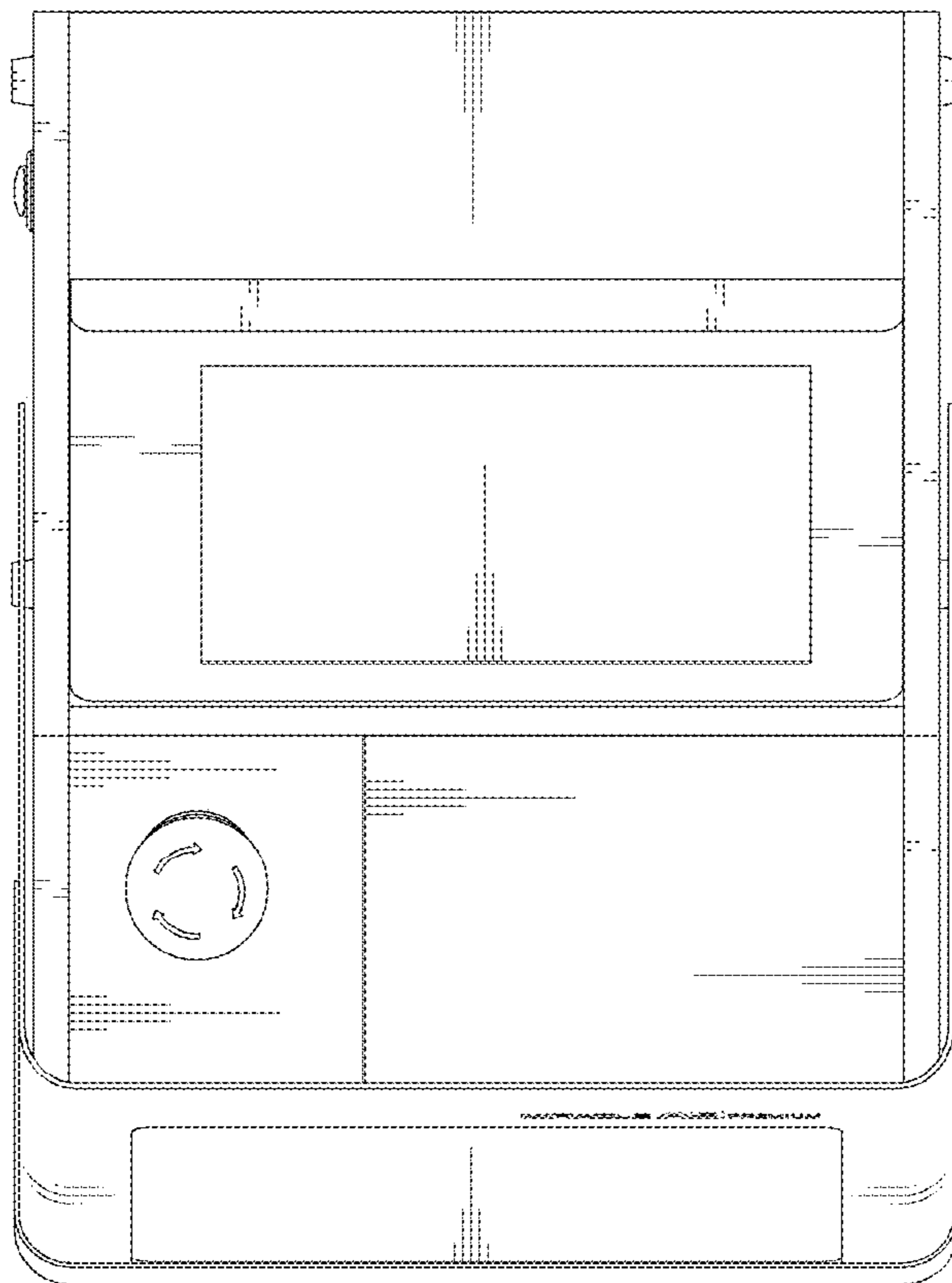

Fig. 7

