



US00D869246S

(12) **United States Design Patent**
Jacobsen

(10) **Patent No.:** **US D869,246 S**

(45) **Date of Patent:** **** Dec. 10, 2019**

- (54) **CAN**
- (71) Applicant: **RTIC IP, LLC**, Houston, TX (US)
- (72) Inventor: **James Matthew Jacobsen**, Houston, TX (US)
- (73) Assignee: **RTIC IP, LLC**, Houston, TX (US)
- (**) Term: **15 Years**
- (21) Appl. No.: **29/622,090**
- (22) Filed: **Oct. 13, 2017**
- (51) **LOC (12) Cl.** **07-01**
- (52) **U.S. Cl.**
USPC **D7/608; D7/629**
- (58) **Field of Classification Search**
USPC D9/500, 502, 516, 530, 537, 539, 542,
D9/549, 763-783; D7/601, 602, 612,
D7/615, 630, 605, 606, 608, 619.1, 619.2,
D7/624.1-624.3, 625, 629
CPC ... B65D 1/00; B65D 1/02; B65D 1/12; B65D
1/14; B65D 1/40; B65D 1/44; B65D
1/023; B65D 1/0223; B65D 1/165; B65D
1/238; B65D 1/246; B65D 1/253; B65D
7/04; B65D 21/0209; B65D 21/0233;
B65D 25/00; B65D 25/28; B65D
41/0457; B65D 41/17; B65D 53/06;
B65D 75/56; B65D 79/005; B65D
2501/0036; B65D 2543/00064; B65D
2543/00074; B65D 2543/00083; B65D
2543/00092; B65D 2543/00101; B65D
2543/00111
See application file for complete search history.

(56) **References Cited**

U.S. PATENT DOCUMENTS

- D217,807 S 6/1970 Livingston
- D230,571 S * 3/1974 Allen D9/779
- 4,163,374 A 8/1979 Moore et al.
- 4,183,226 A 1/1980 Moore et al.
- 4,344,303 A 8/1982 Kelly

- 4,540,611 A 9/1985 Henderson
 - 4,798,063 A 1/1989 Rimmer
 - D301,821 S 6/1989 Bartolo
 - D323,265 S 1/1992 Lu
 - D324,976 S 3/1992 Katz
 - D337,254 S 7/1993 Nakagawa
- (Continued)

OTHER PUBLICATIONS

RTIC-Amazon.com; "RTIC Double Wall Vacuum Insulated Food Container (Stainless Steel, 25ox)"; [online] 'https://www.amazon.com/RTIC-Double-Insulated-Container-Stainless/dp/B07DRNNFR5/ref=sr_1_24?keywords=vacuum+insulated+food+can&qid=1568564102&s=home-garden&sr=1-24; dated Jun. 15, 2018; 8p. (Year: 2018).*

(Continued)

Primary Examiner — Keli L Hill

(74) *Attorney, Agent, or Firm* — Fish & Richardson P.C.

(57) **CLAIM**

The ornamental design for a can, substantially as shown and described.

DESCRIPTION

FIG. 1 is a top, front perspective view of a can showing my new design

FIG. 2 is a front view of the can.

FIG. 3 is a rear view of the can.

FIG. 4 is a right side view of the can.

FIG. 5 is a left side view of the can.

FIG. 6 is a top view looking downward on the can; and,

FIG. 7 is a bottom view looking upward on the can.

The dashed broken lines showing logos as seen on the can body and lid are included for the purpose of illustrating unclaimed portions of the can and forms no part of the claimed design and the dashed broken line as shown in FIG. 7 represents an unclaimed portion of the can and forms no part of the claimed design.

The stippled shading on the lower portion of the can represents a contrasting surface.

1 Claim, 6 Drawing Sheets

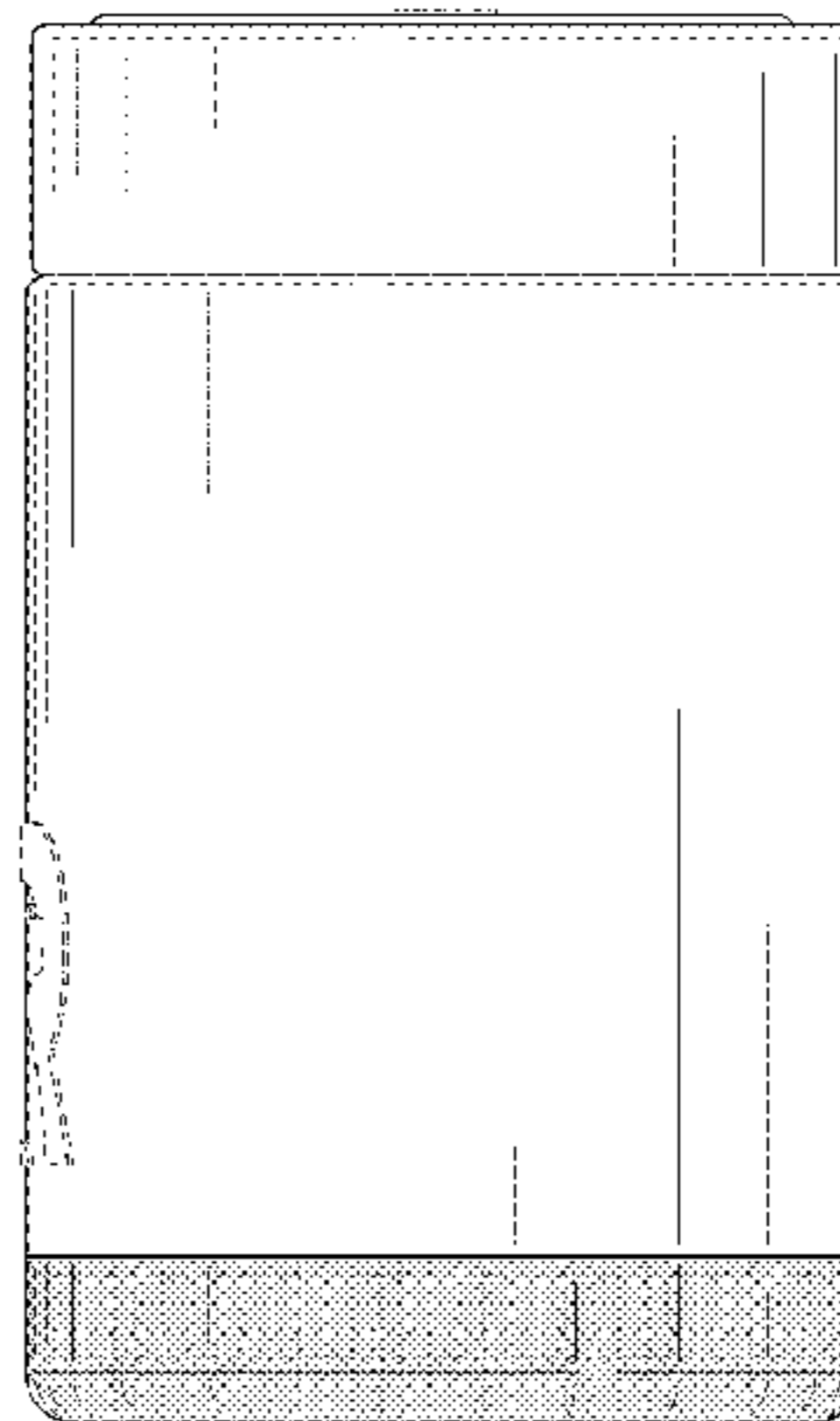
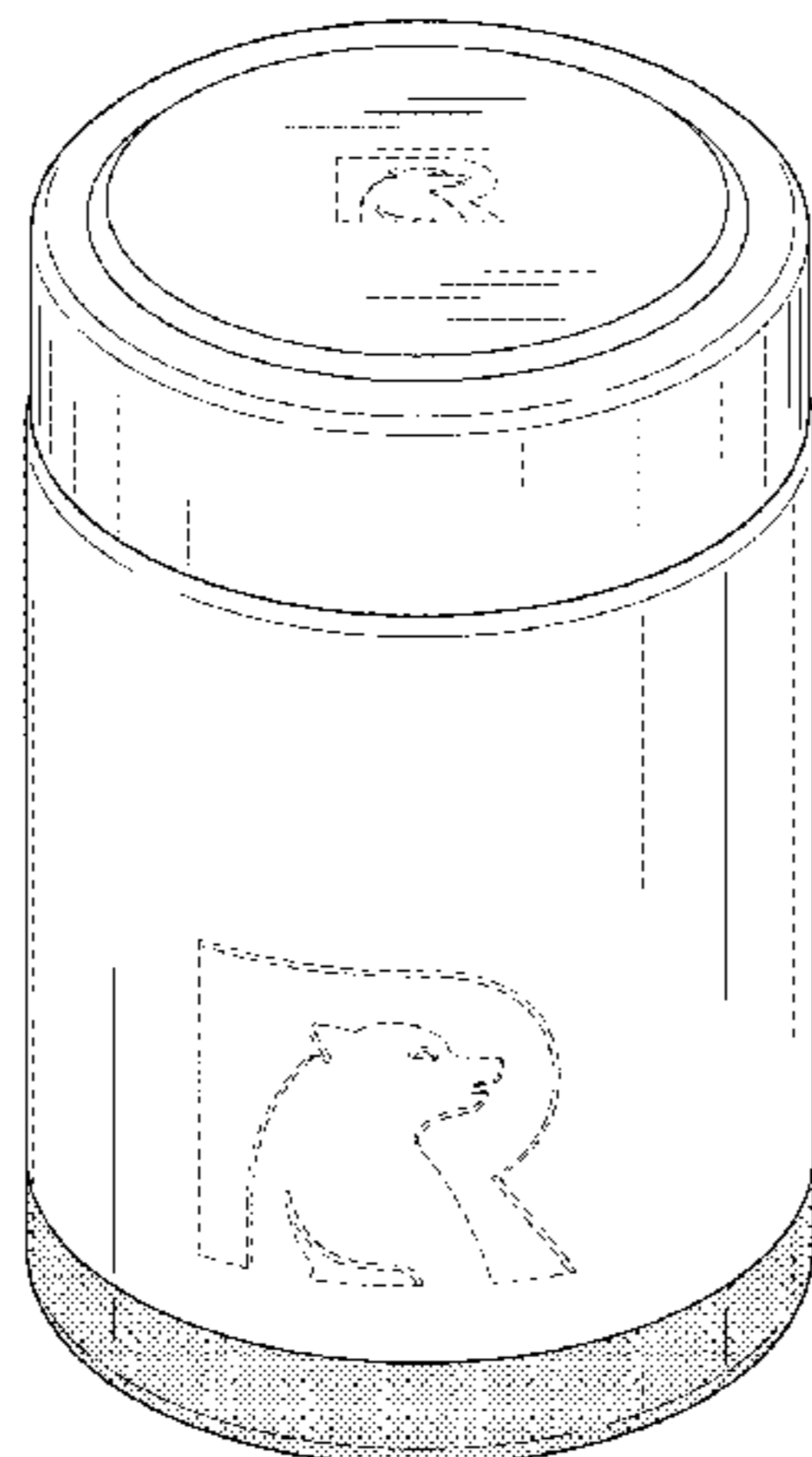

(56)

References Cited

U.S. PATENT DOCUMENTS

| | | | | |
|--------------|-----|---------|-----------------------|----------|
| D347,768 | S | 6/1994 | Anthony et al. | |
| D350,459 | S | 9/1994 | Blackwell et al. | |
| D359,910 | S | 7/1995 | Hirsch | |
| 5,467,891 | A | 11/1995 | Perry | |
| D370,632 | S | 6/1996 | Stonehouse | |
| D372,639 | S | 8/1996 | Kristinik | |
| D408,292 | S | 4/1999 | Gundlach | |
| D408,689 | S | 4/1999 | Kato | |
| 5,915,580 | A | 6/1999 | Melk | |
| D422,455 | S | 4/2000 | Kato | |
| D428,774 | S | 8/2000 | Moran, Jr. | |
| D442,833 | S | 5/2001 | Shuman | |
| D455,052 | S | 4/2002 | Gullickson et al. | |
| D455,612 | S | 4/2002 | Gullickson et al. | |
| 6,626,326 | B2 | 9/2003 | Murakam | |
| D493,365 | S | 7/2004 | Anderson et al. | |
| D497,778 | S * | 11/2004 | Rich | D7/608 |
| D512,269 | S | 12/2005 | Trombly | |
| D557,076 | S | 12/2007 | Wahl | |
| D593,811 | S * | 6/2009 | Carreno | D7/608 |
| D605,529 | S | 12/2009 | Holtrop | |
| D610,871 | S | 3/2010 | Alviar | |
| D622,554 | S * | 8/2010 | Carreno | D7/629 |
| D629,657 | S * | 12/2010 | Carreno | D7/629 |
| D641,591 | S * | 7/2011 | Tsukida | D7/608 |
| D651,050 | S | 12/2011 | Goshi | |
| D652,255 | S | 1/2012 | Carland | |
| 8,251,247 | B1 | 8/2012 | Bickner | |
| D675,880 | S | 2/2013 | Welch | |
| D679,960 | S * | 4/2013 | Hopkins | D7/629 |
| D682,625 | S * | 5/2013 | Lane | D7/629 |
| D709,734 | S * | 7/2014 | Kotani | D7/608 |
| D727,688 | S | 4/2015 | Hewitt et al. | |
| D732,347 | S | 6/2015 | Katterheinrich et al. | |
| D745,811 | S | 12/2015 | Reaux | |
| D752,347 | S | 3/2016 | Seiders et al. | |
| D752,397 | S | 3/2016 | Seiders et al. | |
| 9,340,332 | B2 | 5/2016 | Antal | |
| D759,432 | S * | 6/2016 | Harris | D7/510 |
| D773,250 | S | 12/2016 | Miller | |
| D779,285 | S | 2/2017 | Seiders et al. | |
| D779,891 | S | 2/2017 | Seiders et al. | |
| D779,892 | S | 2/2017 | Seiders et al. | |
| D780,530 | S | 3/2017 | Seiders et al. | |
| D780,531 | S | 3/2017 | Seiders et al. | |
| D780,532 | S | 3/2017 | Seiders et al. | |
| D780,533 | S | 3/2017 | Seiders et al. | |
| D786,025 | S | 5/2017 | Seiders et al. | |
| D787,317 | S * | 5/2017 | Dunn | D9/500 |
| D799,970 | S | 10/2017 | Steel | |
| D803,008 | S * | 11/2017 | Lipsius | D7/615 |
| D804,807 | S * | 12/2017 | Wengreen | D3/203.1 |
| D828,113 | S * | 9/2018 | Fleischhut | D7/608 |
| D829,058 | S * | 9/2018 | Seiders | D7/624.2 |
| D831,428 | S | 10/2018 | Gibson | |
| 2012/0018442 | A1 | 1/2012 | Bollis | |
| 2014/0048551 | A1 | 2/2014 | Slipe | |

OTHER PUBLICATIONS

U.S. Appl. No. 29/621,188, filed Oct. 5, 2017, Jacobsen.
 U.S. Appl. No. 29/621,194, filed Oct. 5, 2017, Jacobsen.
 U.S. Appl. No. 29/622,065, filed Oct. 13, 2017, Jacobsen.
 U.S. Appl. No. 29/639,251, filed Mar. 5, 2018, Jacobsen.
 U.S. Appl. No. 29/639,250, filed Mar. 5, 2018, Jacobsen.
 U.S. Appl. No. 29/639,257, filed Mar. 5, 2018, Jacobsen.
 U.S. Appl. No. 29/639,253, filed Mar. 5, 2018, Jacobsen.
 'amazon.com' [online]. "12 Ounce Stainless Steel Can Cooler Double Wall Vacuum Insulated," Published on or before Oct. 4, 2017, Retrieved from the Internet: URL<https://www.amazon.com/Stainless-Cooler-Double-Vacuum-Insulated/dp/B01M6DNVMV/ref=sr_1_133?ie=UTF8&qid=1517355246&sr=8-133&keywords=can+cooler>. 7 pages.

'amazon.com' [online]. "BlinkOne Can Cooler: Stainless Steel Beverage Bottle Insulator Holder and Cooling Jar (12 Oz)," Published on or before Oct. 4, 2017, Retrieved from the Internet: URL<https://www.amazon.com/dp/B01I27L76S/ref=asc_df_B01I27L76S5354190/?tag=hyprod-20&creative=395033&creativeASIN=B01I27L76S&linkCode=df0&hvadid=167135973835&hvpos=1o1&hvnetw=g&hvrand=11702563197056202857&hvpone=&hvptwo=&hvqmt=&hvdev=c&hvdvcmdl=&hvlocint=&hvlocphy=9031353&hvtargid=pla-305991917949>. 8 pages.

'amazon.com' [online]. "BOBOROOM Thermos Food Jar, 18/8 Stainless Steel 17 Ounce (500ml) Double Wall Vacuum Insulated Thermos Lunch Box Container Jar. (Green)," Published on or before Oct. 4, 2017, Retrieved from the Internet: URL<https://www.amazon.com/BOBOROOM-Thermos-Stainless-Insulated-Container/dp/B01N7CEDDC/ref=sr_1_352?s=kitchen&ie=UTF8&qid=1516720748&sr=1-352&keywords=food+jar>. 7 pages.

'amazon.com' [online]. "Buy 1—Get 1 Free! Stainless Steel Can Cooler Sleeve | 12 oz Insulated Beer Can Cooler & Bottle Cooler | 100% Satisfaction Risk-Free Satisfaction Promise (2-Pack, Matte Black)," Published on or before Oct. 4, 2017, Retrieved from the Internet: URL<https://www.amazon.com/Buy-Stainless-Insulated-Satisfaction-Risk-Free/dp/B072JWYRTJ/ref=cm_cr_ar_p_d_product_top?ie=UTF8>. 7 pages.

'amazon.com' [online]. "ColdKeeper Double Insulated Personal Beverage Cooler Can—Fits All Standard 16oz Cans (16oz Compatible, Stainless Steel)," Published on or before Oct. 4, 2017, Retrieved from the Internet: URL<https://www.amazon.com/ColdKeeper-Double-Insulated-Personal-Beverage/dp/B01J65ZY1E/ref=lp_17569889011_1_1?srs=17569889011&ie=UTF8&qid=1517353225&sr=8-1>. 9 pages.

'amazon.com' [online]. "Counter Aid 2 Pack Double Insulated Can Cooler—12oz Bottle and Can Holder Chills Drinks for Hours—Stainless steel (2)," Published on or before Oct. 4, 2017, Retrieved from the Internet: URL<https://www.amazon.com/Counter-Aid-Insulated-Cooler-Stainless/dp/B06XDGB2BV/ref=sr_1_20_sspa?ie=UTF8&qid=1517355129&sr=8-20-spons&keywords=can+cooler&psc=1>. 8 pages.

'amazon.com' [online]. "Fatmingo Vacuum Insulated Food Jar Thermos 18/8 Stainless Steel Water-tight Container, 35oz / 1.0L Silver," Published on or before Oct. 4, 2017, Retrieved from the Internet: URL<https://www.amazon.com/Fatmingo-Insulated-Stainless-Water-tight-Container/dp/B01N8QUUBG/ref=sr_1_65?s=kitchen&ie=UTF8&qid=1516719676&sr=1-65&keywords=food+jar>. 8 pages.

'amazon.com' [online]. "FRZN Double Walled Vacuum Insulated Can Cooler, 12 oz, Stainless Steel," Published on or before Oct. 4, 2017, Retrieved from the Internet: URL<https://www.amazon.com/dp/B01MA4X8EW/ref=asc_df_B01MA4X8EW5354237/?tag=hyprod=20&creative=394997&creativeASIN=B01MA4X8EW&linkCode=df0&hvadid=216554116525&hvpos=3o14&hvnetw=g&hvrand=2863075073623141504&hvpone=&hvptwo=&hvqmt=&hvdev=c&hvdvcmdl=&hvlocint=&hvlocphy=9031353&hvtargid=pla-350181080571>. 6 pages.

'amazon.com' [online]. "Improved Design—Cayman Kitchen 16 oz Insulated Stainless Steel Thermos Food Jar—Perfect for Lunch on the Go," Published on or before Oct. 4, 2017, Retrieved from the Internet: URL<https://www.amazon.com/Improved-Design-Kitchen-Insulated-Stainless/dp/B01BT5EF2S/ref=sr_1_56?s=kitchen&ie=UTF8&qid=1516719676&sr=1-56&keywords=food+jar>. 9 pages.

'amazon.com' [online]. "Infinity Jars 250 ml (8.3 fl oz) Tall Black Ultraviolet Refillable Empty Glass Screw Top Jar," Published on or before Oct. 4, 2017, Retrieved from the Internet: URL<https://www.amazon.com/Infinity-Jars-Black-Ultraviolet-Refillable/dp/B00N463G8K/ref=sr_1_318?s=kitchen&ie=UTF8&qid=1516720725&sr=1-318&keywords=food+jar>. 8 pages.

'amazon.com' [online]. "Isosteel VA-9684AT 17 fl. oz 18/8 Stainless Steel Double-Wall Vacuum Food Container, Titanium Gray," Published on or before Oct. 4, 2017, Retrieved from the Internet: URL<https://www.amazon.com/Isosteel-VA-9684AT-Stainless-Double-Wall-Container/dp/B0144VJ1X2/ref=sr_1_123_sspa?s=kitchen&ie=UTF8&qid=1516720152&sr=1-123-spons&keywords=food+jar&psc=1>. 7 pages.

'amazon.com' [online]. "Keep It Cold—One Premium Quality Standard 12 oz Beverage Beer Bottle and 12/16 oz Can Insulator

(56)

References Cited

OTHER PUBLICATIONS

Cooler Sleeve—Stainless Steel Super Insulated With Flex-cap Keep Drinks Ice Cold,” Published on or before Oct. 4, 2017, Retrieved from the Internet: URL<https://www.amazon.com/dp/B01LARMUD6/ref=asc_df_B01LARMUD65354190/?tag=hyprod-20&creative=395033&creativeASIN=B01LARMUD6&linkCode=df0&hvadid=198056825231&hvpos=1o1&hvnetw=g&hvrand=14602686192363596414&hvpon=&hvptwo=&hvqmt=&hvdev=c&hvdvcmdl=&hvlocint=&hvlocphy=9031353&hvtargid=pla-349778068010>. 7 pages.

‘amazon.com’ [online]. “KelvZ Insulated Stainless Can Cooler Beer Holder—Fits All Standard 12oz Cans & Bottles + Bonus 2 Stylish Coolies—Top Quality Can & Bottle Insulator, No-Sweat Ergonomic Design—Sleek & Effective!” Published on or before Oct. 4, 2017, Retrieved from the Internet: URL<https://www.amazon.com/KelvZ-Insulated-Stainless-Cooler-Holder/dp/B01LZ44Y4X/ref=sr_1_68?ie=UTF8&qid=1517355201&sr=8-68&keywords=can+cooler>. 8 pages.

‘amazon.com’ [online]. “Kenley Beer Can Cooler Insulator—Holder Colster for Cans Drink Beverage Soda—Stainless Steel—Double Wall Vacuum Insulation,” Published on or before Oct. 4, 2017, Retrieved from the Internet: URL<https://www.amazon.com/dp/B01EYP48X6/ref=asc_df_B01EYP48X65354239/?tag=hyprod-20&creative=395033&creativeASIN=B01EYP48X6&linkCode=df0&hvadid=229200252920&hvpos=1o1&hvnetw=g&hvrand=9882065043405778392&hvpon=&hvptwo=&hvqmt=&hvdev=c&hvdvcmdl=&hvlocint=&hvlocphy=9031353&hvtargid=pla-390949703746>. 9 pages.

‘amazon.com’ [online]. “Klean Kanteen Vacuum Insulated Food Canister with Stainless Lid, Brushed Stainless, 8-Ounce : Klean Kanteen Canister,” Published on or before Oct. 4, 2017, Retrieved from the Internet: URL<<https://www.amazon.com/Klean-Kanteen-Vacuum-Insulated-Canister/dp/B00CWMN1ZU>>. 7 pages.

‘amazon.com’ [online]. “LunchBots Thermal 12 oz. All Stainless Steel Interior—Insulated Food Container Stays Warm for 6 Hours or Cold for 12 Hours—Leak Proof Soup Jar for Portable Convenience—Green,” Published on or before Oct. 4, 2017, Retrieved from the Internet: URL<https://www.amazon.com/LunchBots-Thermal-Stainless-Steel-Interior/dp/B01DTHPI0M/ref=cm_cr_ar_p_d_product_top?ie=UTF8>. 7 pages.

‘amazon.com’ [online]. “New Wave Enviro 350 ML Stainless Steel Insulated Food Container in partnership with Healthy Child Healthy World,” Published on or before Oct. 4, 2017, Retrieved from the Internet: URL<https://www.amazon.com/dp/B005MJCXJU/ref=asc_df_B005MJCXJU5346352/?tag=hyprod-20&creative=394997&creativeASIN=B005MJCXJU&linkCode=df0&hvadid=194859264681&hvpos=1o2&hvnetw=g&hvrand=3842558629095747931&hvpon=&hvptwo=&hvqmt=&hvdev=c&hvdvcmdl=&hvlocint=&hvlocphy=9031293&hvtargid=pla-311627355521>. 5 pages.

‘amazon.com’ [online]. “Noble Wild | Stainless Steel Can Insulator (Blue),” Published on or before Oct. 4, 2017, Retrieved from the Internet: URL<<https://www.amazon.com/dp/B01H658TY0/>>. 5 pages.

‘amazon.com’ [online]. “Only 18/10 Stainless Steel Double Wall GUS Can Cooler, Vacuum Insulated Bottle Keeps Standard Size Bottles/Cans and Cups Ice Cold/Hot,” Published on or before Oct. 4, 2017, Retrieved from the Internet: URL<https://www.amazon.com/Stainless-GUS-Insulated-Standard-Bottles/dp/B07194P2GK/ref=sr_1_40?ie=UTF8&qid=1517355165&sr=8-40&keywords=can+cooler>. 8 pages.

‘amazon.com’ [online]. “Premium Can Cooler | Durable Stainless Steel Powder Coated Double Wall Vacuum Insulated | Keep your Drink Cold to the,” Published on or before Oct. 4, 2017, Retrieved from the Internet: URL<https://www.amazon.com/Stainless-Insulated-Beverage-Insulator-available/dp/B01ETXFJTA/ref=sr_1_46?ie=UTF8&qid=1517355165&sr=8-46&keywords=can+cooler>. 9 pages.

‘amazon.com’ [online]. “Simple Modern Provision—16oz Provision Food Jar—Vacuum Insulated 18/8 Stainless Steel Leak Proof Food Storage Container—Hydro Thermos Flask—Lilac ,” Published on or before Oct. 4, 2017, Retrieved from the Internet:

URL<https://www.amazon.com/Simple-Modern-Provision-Insulated-Stainless/dp/B076HKZP1T/ref=cm_cr_ar_p_d_product_top?ie=UTF8&th=1>. 9 pages.

‘amazon.com’ [online]. “Stainless Steel 12oz Can Cooler & Bottle Insulator,” Published on or before Oct. 4, 2017, Retrieved from the Internet: URL<https://www.amazon.com/dp/B01MG8YHE2/ref=asc_df_B01MG8YHE25354239/?tag=hyprod-20&creative=395033&creativeASIN=B01MG8YHE2&linkCode=df0&hvadid=198057551909&hvpos=1o4&hvnetw=g&hvrand=3278016650215874220&hvpon=&hvptwo=&hvqmt=&hvdev=c&hvdvcmdl=&hvlocint=&hvlocphy=9031353&hvtargid=pla-350542365104>. 6 pages.

‘amazon.com’ [online]. “Stainless Steel Double Wall Insulated Can Cooler for Keeping Your Beverage of Choice Colder Longer Guaranteed Even LongAs the More Expensive Can Coolers!” Published on or before Oct. 4, 2017, Retrieved from the Internet: URL<https://www.amazon.com/Stainless-Insulated-Beverage-Guaranteed-Expensive/dp/B01H7FH3IW/ref=sr_1_34_sspa?ie=UTF8&qid=1517355165&sr=8-34-spons&keywords=can+cooler&psc=1>. 7 pages.

‘amazon.com’ [online]. “Tahoe Trail 12 oz Stainless Steel Double Wall Vacuum Insulated Can Cooler (purple),” Published on or before Oct. 4, 2017, Retrieved from the Internet: URL<https://www.amazon.com/Tahoe-Trail-Stainless-Double-Insulated/dp/B072KBHCW9/ref=sr_1_10?ie=UTF8&qid=1517355129&sr=8-10&keywords=can+cooler>. 7 pages.

‘amazon.com’ [online]. “The Arctic Giant—Premium Insulated Beverage Can Cooler + Bonus Comfort Grip—Fits Standard 12oz Cans and Bottles|Durable Stainless Steel (Stainless Steel),” Published on or before Oct. 4, 2017, Retrieved from the Internet: URL<https://www.amazon.com/Arctic-Giant-Insulated-Beverage-Stainless/dp/B073SD4XXG/ref=sr_1_230?ie=UTF8&qid=1517355387&sr=8-230&keywords=can+cooler>. 6 pages.

‘amazon.com’ [online]. “Thermos 16 Ounce Stainless Steel Food Jar, Black,” Published on or before Oct. 4, 2017, Retrieved from the Internet: URL<https://www.amazon.com/Thermos-Ounce-Stainless-Steel-Black/dp/B00472MNIY/ref=sr_1_16?s=kitchen&ie=UTF8&qid=1516719576&sr=1-16&keywords=food+jar>. 7 pages.

‘amazon.com’ [online]. “Thermos Nissan Stainless Steel 10 Ounce Food Jar with Black Lid, Set of 2,” Published on or before Oct. 4, 2017, Retrieved from the Internet: URL<https://www.amazon.com/Thermos-Nissan-Stainless-Steel-Ounce/dp/B011CJ7DF2/ref=sr_1_391?s=kitchen&ie=UTF8&qid=1516720779&sr=1-391&keywords=food+jar>. 5 pages.

‘amazon.com’ [online]. “Thermos Stainless Steel Beverage Can Insulator for 12 Ounce Can: Thermo Can Coolers,” Published on or before Oct. 4, 2017, Retrieved from the Internet: URL<<https://www.amazon.com/Thermos-Stainless-Steel-Beverage-Insulator/dp/B0000644AF>>. 10 pages.

‘amazon.com’ [online]. “Tiger Corporation MCJ-A050 Stainless Steel Food Jar, 16 oz, Framboise Pink,” Published on or before Oct. 4, 2017, Retrieved from the Internet: URL<https://www.amazon.com/Tiger-Corporation-MCJ-A050-Stainless-Framboise/dp/B01MZF61CJ/ref=sr_1_17?s=kitchen&ie=UTF8&qid=1516719576&sr=1-17&keywords=food+jar>. 9 pages.

‘amazon.com’ [online]. “Utopia 12oz Stainless Steel Double Wall Insulated Can Cooler—No Sweat Exterior—Easy to Clean—by Utopia Home,” Published on or before Oct. 4, 2017, Retrieved from the Internet: URL<https://www.amazon.com/Utopia-Stainless-Double-Insulated-Cooler/dp/B06Y5XD2MV/ref=sr_1_61?ie=UTF8&qid=1517355188&sr=8-61&keywords=can+cooler>. 7 pages.

‘amazon.com’ [online]. “Zoie + Chloe Vacuum Insulated Stainless Steel Food Jar 17oz / 500ml,” Published on or before Oct. 4, 2017, Retrieved from the Internet: URL<https://www.amazon.com/Zoie-Chloe-Vacuum-Insulated-Stainless/dp/B01N9HBUNM/ref=sr_1_33?s=kitchen&ie=UTF8&qid=1516719641&sr=1-33&keywords=food+jar>. 8 pages.

‘amazon.com’ [online]. “Zojirushi Stainless Steel Food Jar, 19 oz/0.55 L, Metallic Red,” Published on or before Oct. 4, 2017, Retrieved from the Internet: URL<https://www.amazon.com/Zojirushi-Stainless-Steel-Food-Metallic/dp/B00UWR738S/ref=sr_1_36?s=kitchen&ie=UTF8&qid=1516719641&sr=1-36&keywords=food+jar>. 7 pages.

(56)

References Cited

OTHER PUBLICATIONS

'corkcicle.com' [online]. "Corkcicle® Waterman Arctican," Published on or before Oct. 4, 2017, Retrieved from the Internet: URL<<https://corkcicle.com/products/waterman-arctican?variant=477307797519>> 4 pages.

'hydroflask.com' [online]. "12oz Food Flask," Published on or before Oct. 4, 2017, Retrieved from the Internet: URL<https://www.hydroflask.com/12-oz-food-flask-2#92=58?gclid=CjwKCAiA15vTBRAHEiwA7Snfc2Ts44cQg-_1mDQo8cIBdDUyVX0HLEqq8ce4T99uGm6U—a5W0cuY2xoCyJEQAvD_BwE&mkwid=s3ksVm7SX_219938359404_c&mtid=23047xr15990&slid=&product_id=F12B415>. 16 pages.

'kohls.com' [online]. "Skip Hop Zoo 11-ounce Insulated Food Jar," Published on or before Oct. 4, 2017, Retrieved from the Internet: URL<https://www.kohls.com/product/prd-2456812/skip-hop-zoo-11-ounce-insulated-food-jar.jsp?ci_mcc=ci&utm_campaign=EC%20BABY%20NON-APPAREL&utm_medium=CSE&utm_source=google&utm_product=33857722&CID=shopping15&utm_campaignid=196835012&gclid=CjwKCAiA15vTBRAHEiwA7Snfcykm8OnodlyZQRpt5Q_UHew_a5frpr7qv-wWzboQxt-hNxpN76YpUxoCIR4QAvD_BwE&gclid=aw.ds&dclid=CPXgs-yr7tgCFZWBaQodGTUOqQ>. 3 pages.

'lakeside.com' [online]. "Stainless Steel Drinkware," Published on or before Oct. 4, 2017, Retrieved from the Internet: URL<https://www.lakeside.com/Kitchen---Dining/Drinkware---Mugs/Stainless+Steel+Drinkware/prod2610097.jsp?cid=GooglePLA-336057013&ukwid=+&product_id=336057013&adpos=1o1&creative=199260148023&device=c&matchtype=&network=g&gclid=Cj0KCQiAzMDTBRDDARIsABX4AWw31QxCEl1Od5wnnPTK8qfypEzUZ2efyRQhC1WLBVmlFd9PY23EVulaAnMJEALw_wcB>. 4 pages.

'target.com' [online]. "Thermos 10oz Vacuum Insulated Food Jar," Published on or before Oct. 4, 2017, Retrieved from the Internet: URL<<https://www.target.com/p/thermos-10oz-vacuum-insulated-food-jar/-/A-14386058>>. 4 pages.

'walmart.com' [online]. "Ozark Trail 12-Ounce Vacuum Insulated Can Cooler with Metal Gasket," Published on or before Oct. 4, 2017, Retrieved from the Internet: URL<<https://www.walmart.com/ip/Ozark-Trail-12-Ounce-Vacuum-Insulated-Can-Cooler-with-Metal-Gasket/54304693?wmlspartner=wlpa&selectedSellerId=0>>. 6 pages.

'yeti.com' [online]. "Rambler Colster Beer Insulator," Published on or before Oct. 4, 2017, Retrieved from the Internet: URL<<https://www.yeti.com/drinkware/colster/YRAMCOLSTER.html>>. 9 pages. Stainless Steel Can, RTIC IP, LLC, first disclosed on Nov. 1, 2015, 7 pages.

12 oz. Food Container Stainless, [online]; [item review published on Dec. 16, 2017]; [retrieved from the Internet on Jun. 21, 2019] URL<<https://www.rticcoolers.com/shop/food/Food-Container-12oz-Stainless.>> 3 pages (Year 2017).

LunchBots Thermal 8 oz All Stainless Steel Interior [online] [article published on Amazon on Apr. 5, 2016] [retrieved from the Internet on Jun. 21, 2019] URL<https://www.amazon.com/dp/B01DTHPJXS/ref+sspa_dk_detail_4?psc+1&pd_rd_i+B01DTHPJXS.> 2 pages (Year 2016).

RTIC Double Wall Vacuum Insulated Food Container [online] [article published to Amazon on Jun. 15, 2018] [retrieved from the Internet on Jun. 21, 2019] URL<<https://www.amazon.com/RTIC-Double-Insulated-Container-Stainless/dp/B07DRNNFR5.>> 2 pages (Year 2018).

U.S. Appl. No. 29/668,445, filed Oct. 30, 2018, Jacobsen.

U.S. Appl. No. 29/668,451, filed Oct. 30, 2018, Jacobsen.

* cited by examiner

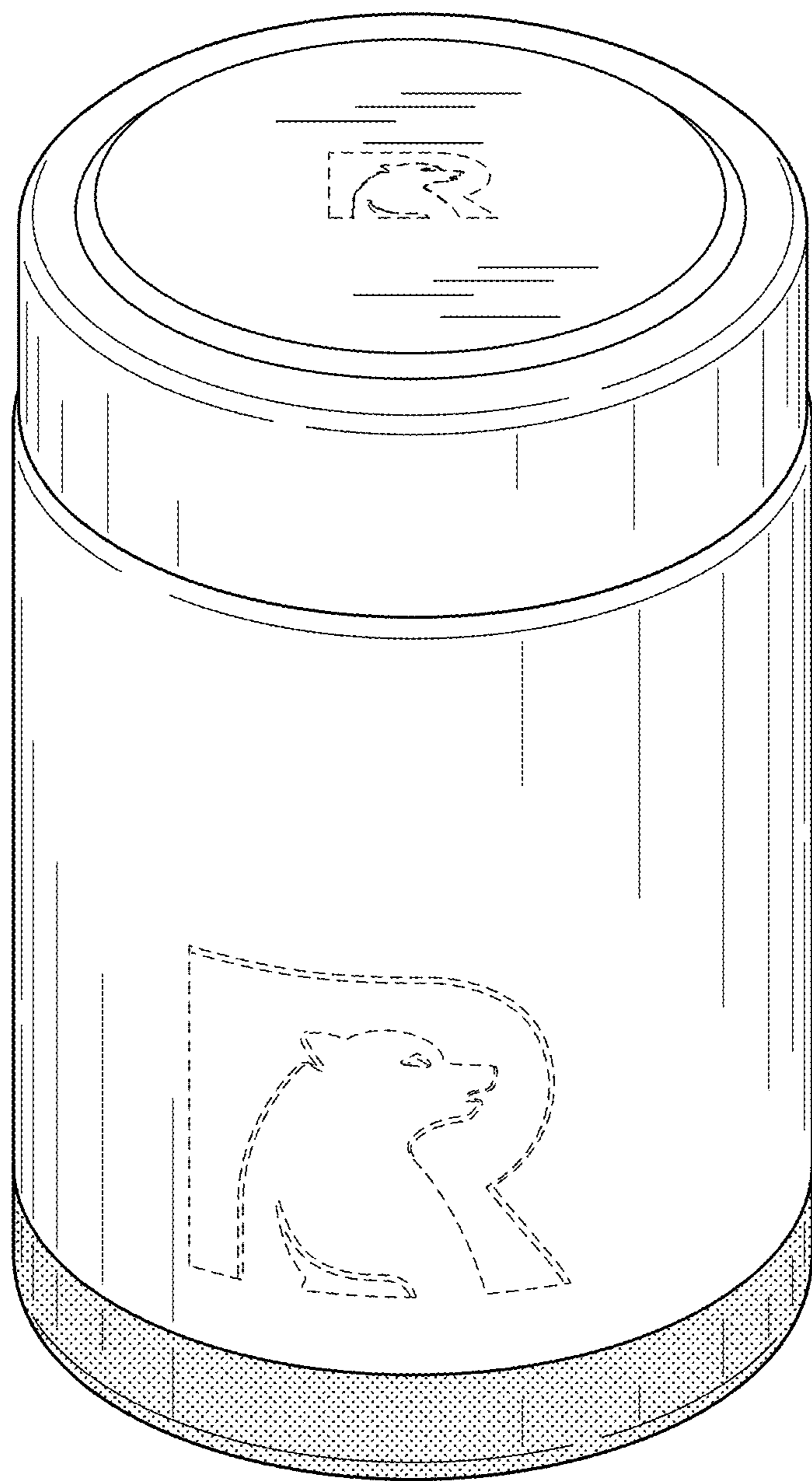

FIG. 1

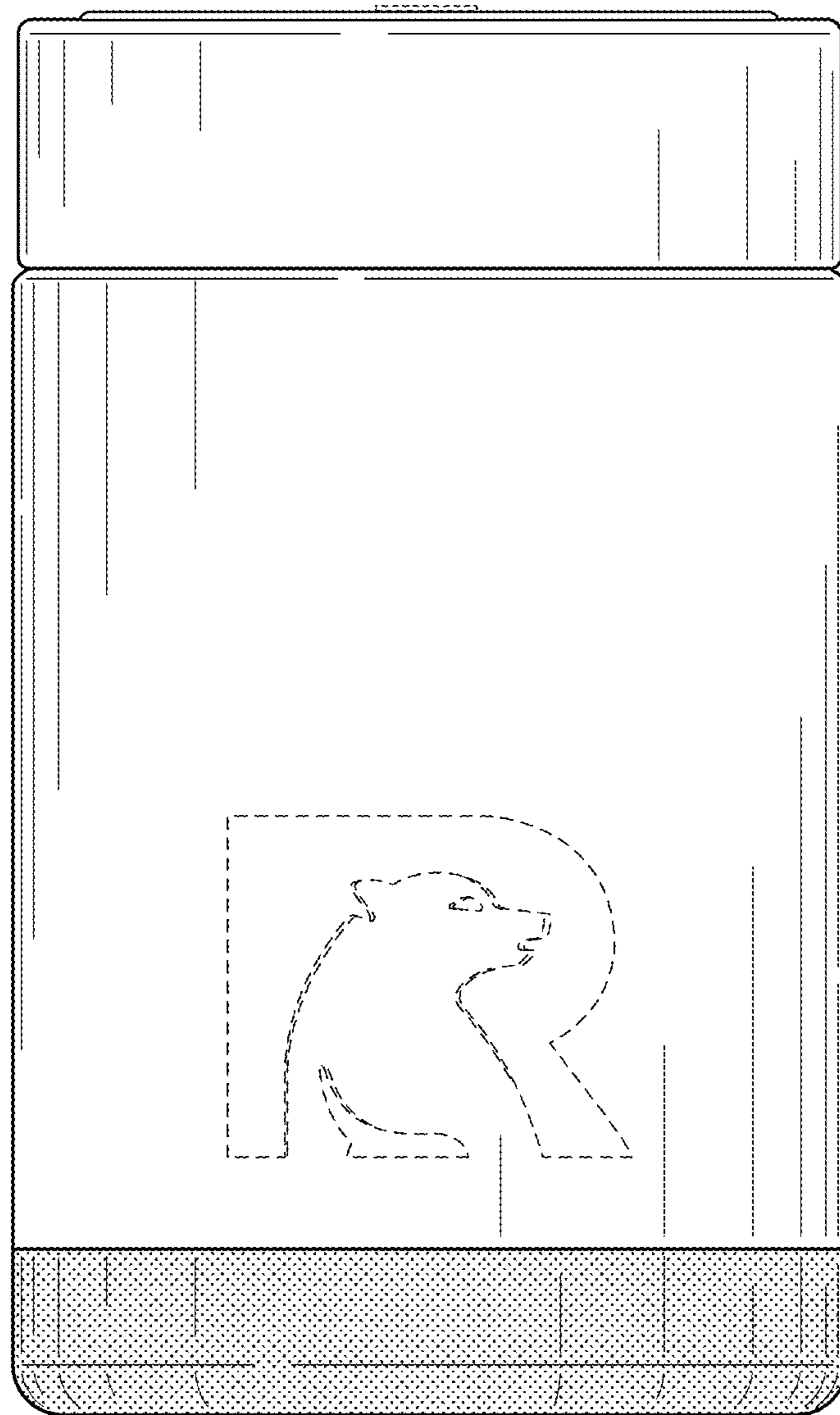

FIG. 2



FIG. 3

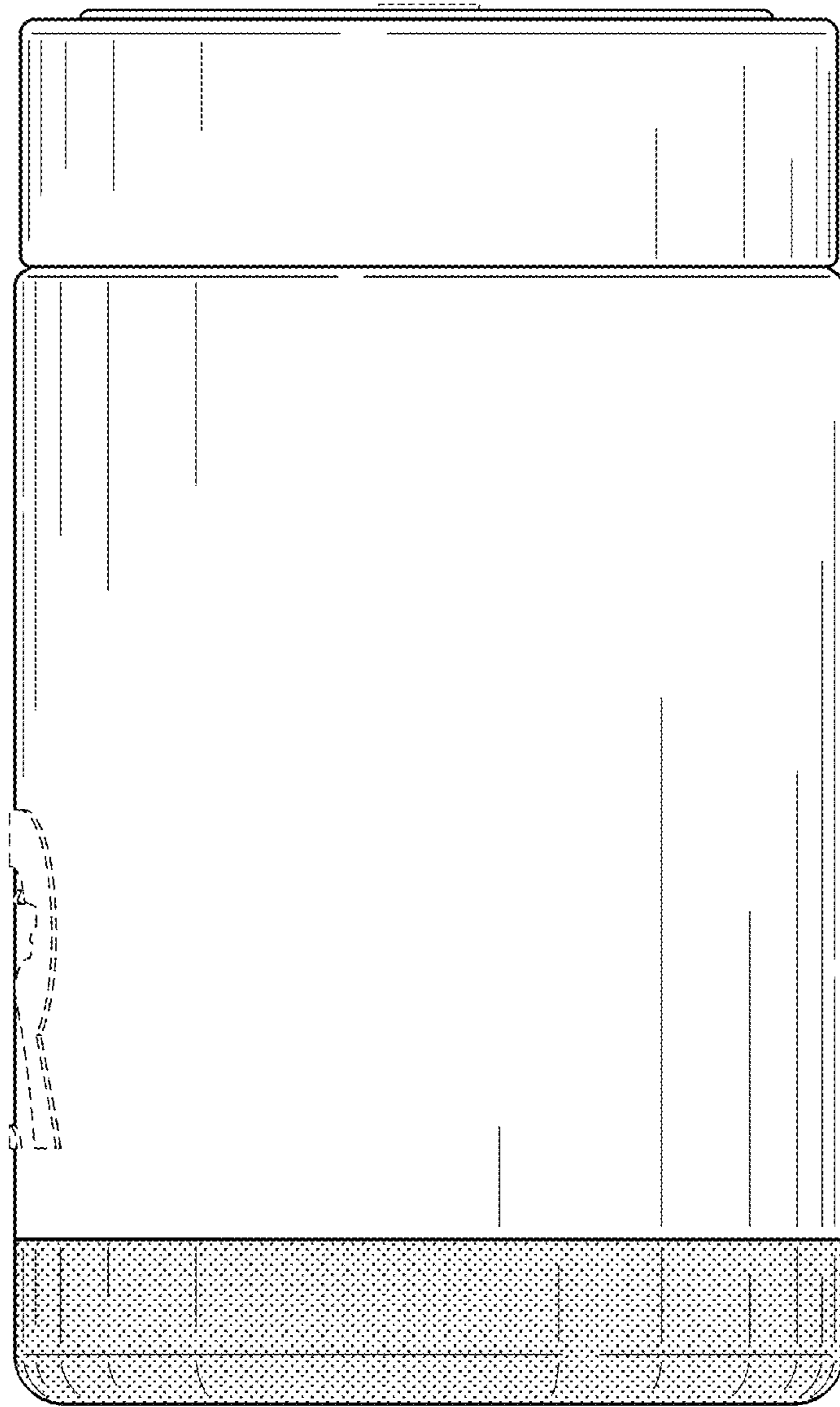

FIG 4

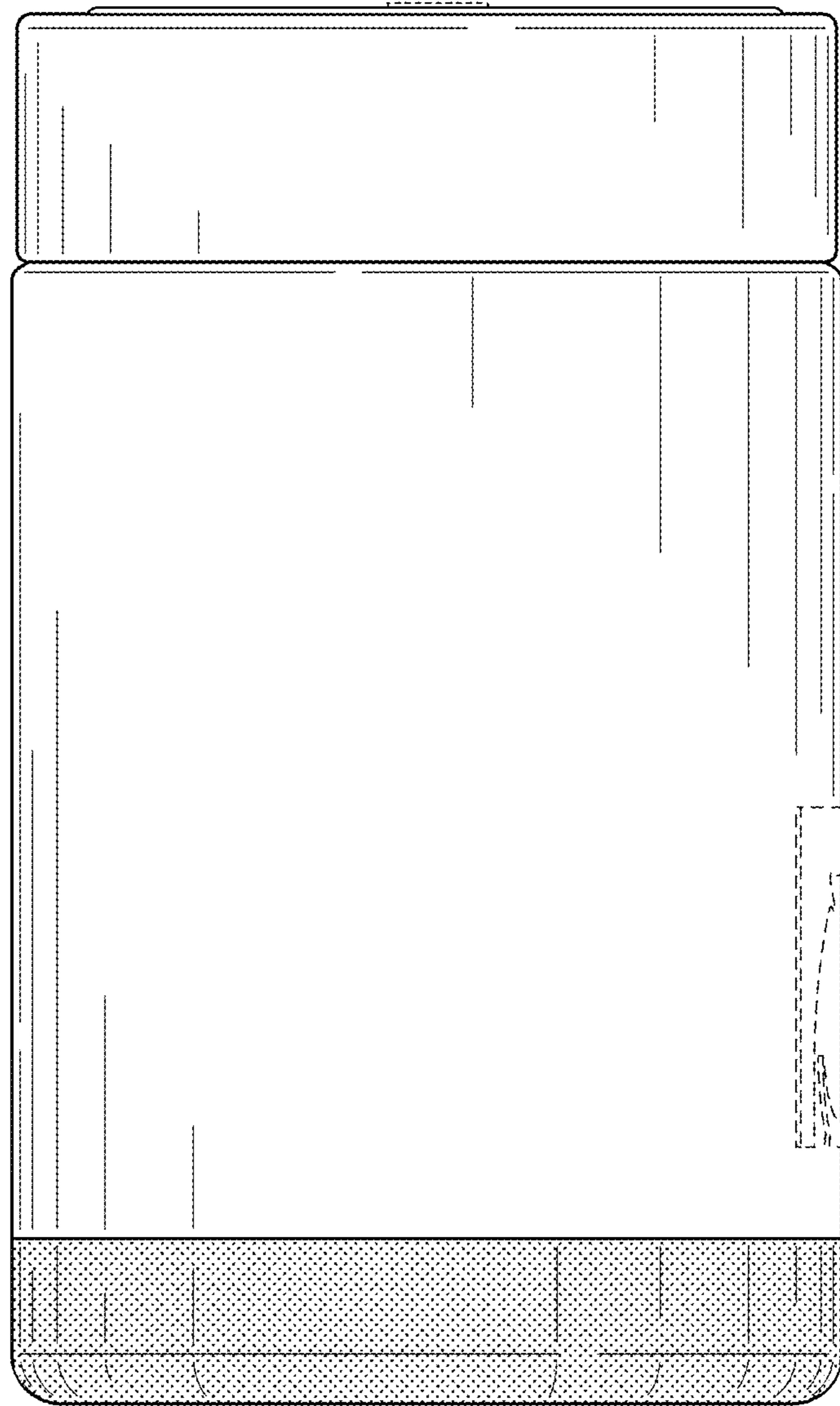

FIG 5

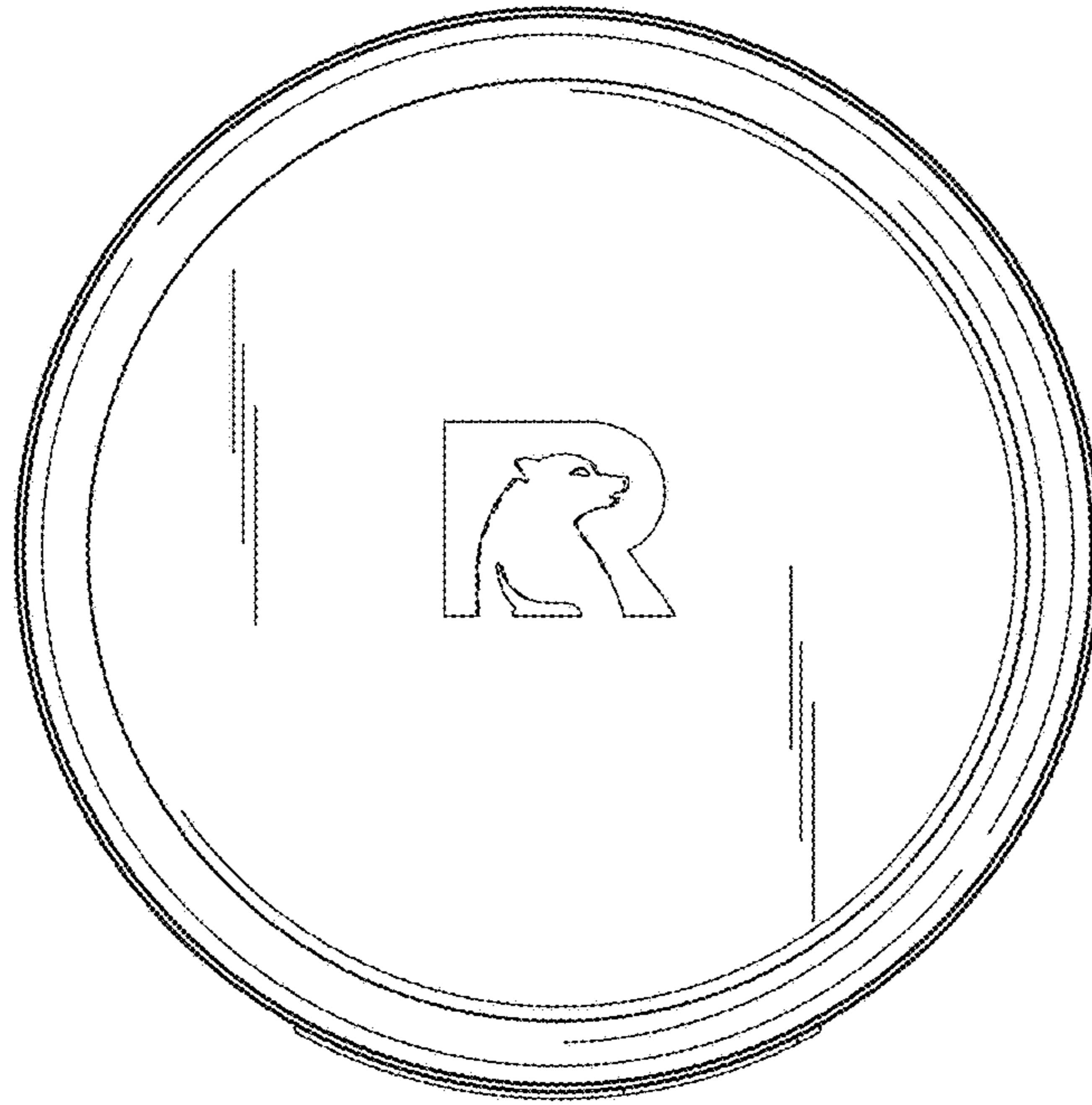

FIG. 6

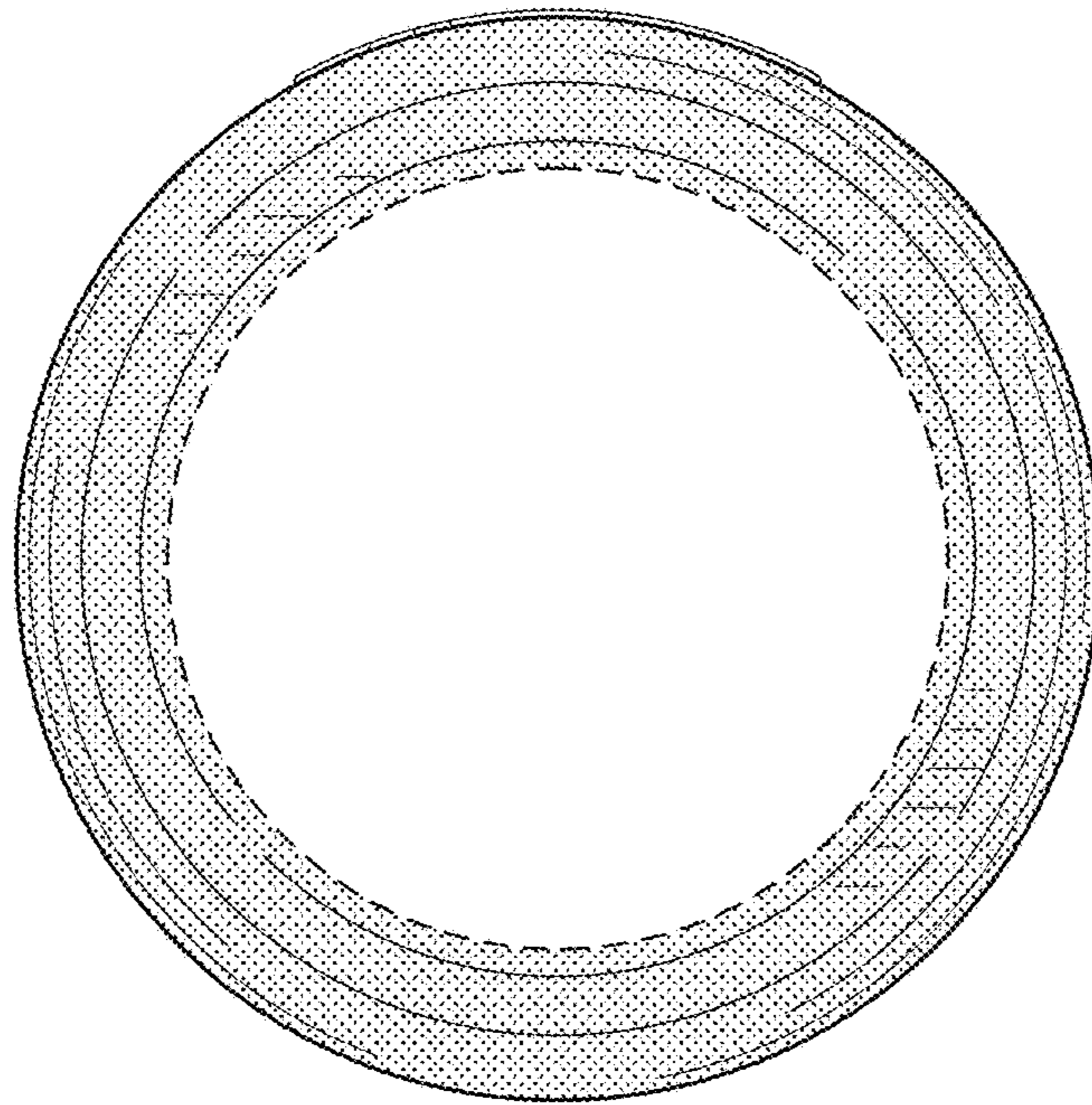

FIG. 7