



US00D869212S

(12) **United States Design Patent** (10) **Patent No.:** **US D869,212 S**  
**Maager** (45) **Date of Patent:** **\*\* Dec. 10, 2019**

(54) **FITTING FOR FURNITURE**  
(71) Applicant: **Julius Blum GmbH**, Hoechst (AT)  
(72) Inventor: **Frank Maager**, Sulzburg (DE)  
(73) Assignee: **JULIUS BLUM GMBH**, Hoechst (AT)  
(\*\*) Term: **15 Years**

(21) Appl. No.: **29/632,834**  
(22) Filed: **Jan. 10, 2018**

(30) **Foreign Application Priority Data**

Jul. 11, 2017 (EM) ..... 4097806

(51) **LOC (12) Cl.** ..... **06-06**  
(52) **U.S. Cl.**  
USPC ..... **D6/702**

(58) **Field of Classification Search**  
USPC ..... D6/356, 654, 702, 703, 705, 716.2;  
D12/171, 169, 195; D13/119; D30/101  
CPC ..... E02D 29/14; F16B 35/04; G06F 3/03549;  
G06F 3/03543; G06F 3/0312; G06F  
3/0213; G06F 3/038; H01M 2/10; H01M  
2/1055

See application file for complete search history.

(56) **References Cited**

**U.S. PATENT DOCUMENTS**

1,335,613 A \* 3/1920 Cuno ..... F16B 35/041  
411/368  
2,818,463 A \* 12/1957 Parker ..... H01M 2/1055  
429/99  
4,873,795 A \* 10/1989 Spiess ..... E02D 29/14  
52/20  
D382,537 S \* 8/1997 Brunette ..... D13/103  
D425,858 S \* 5/2000 Oliver ..... D13/119  
6,141,034 A \* 10/2000 McCutchen ..... G02B 27/22  
348/36  
6,172,665 B1 \* 1/2001 Bullister ..... G06F 3/0213  
345/163

D590,190 S \* 4/2009 Held ..... D6/716.2  
D633,735 S \* 3/2011 Held ..... D6/716.2  
D662,673 S \* 6/2012 Stevenson ..... D30/101  
D686,016 S \* 7/2013 Gasser ..... D6/705  
D686,017 S \* 7/2013 Gasser ..... D6/705  
D789,717 S \* 6/2017 Renjilian ..... D6/705  
D793,304 S \* 8/2017 McMath ..... D12/169  
D811,970 S \* 3/2018 Lokers ..... D12/195  
D811,971 S \* 3/2018 Lokers ..... D12/195  
D817,676 S \* 5/2018 Herring ..... D6/705

(Continued)

*Primary Examiner* — Kevin K Rudzinski  
*Assistant Examiner* — Paul D Bohannon  
(74) *Attorney, Agent, or Firm* — Wenderoth, Lind & Ponack, L.L.P.

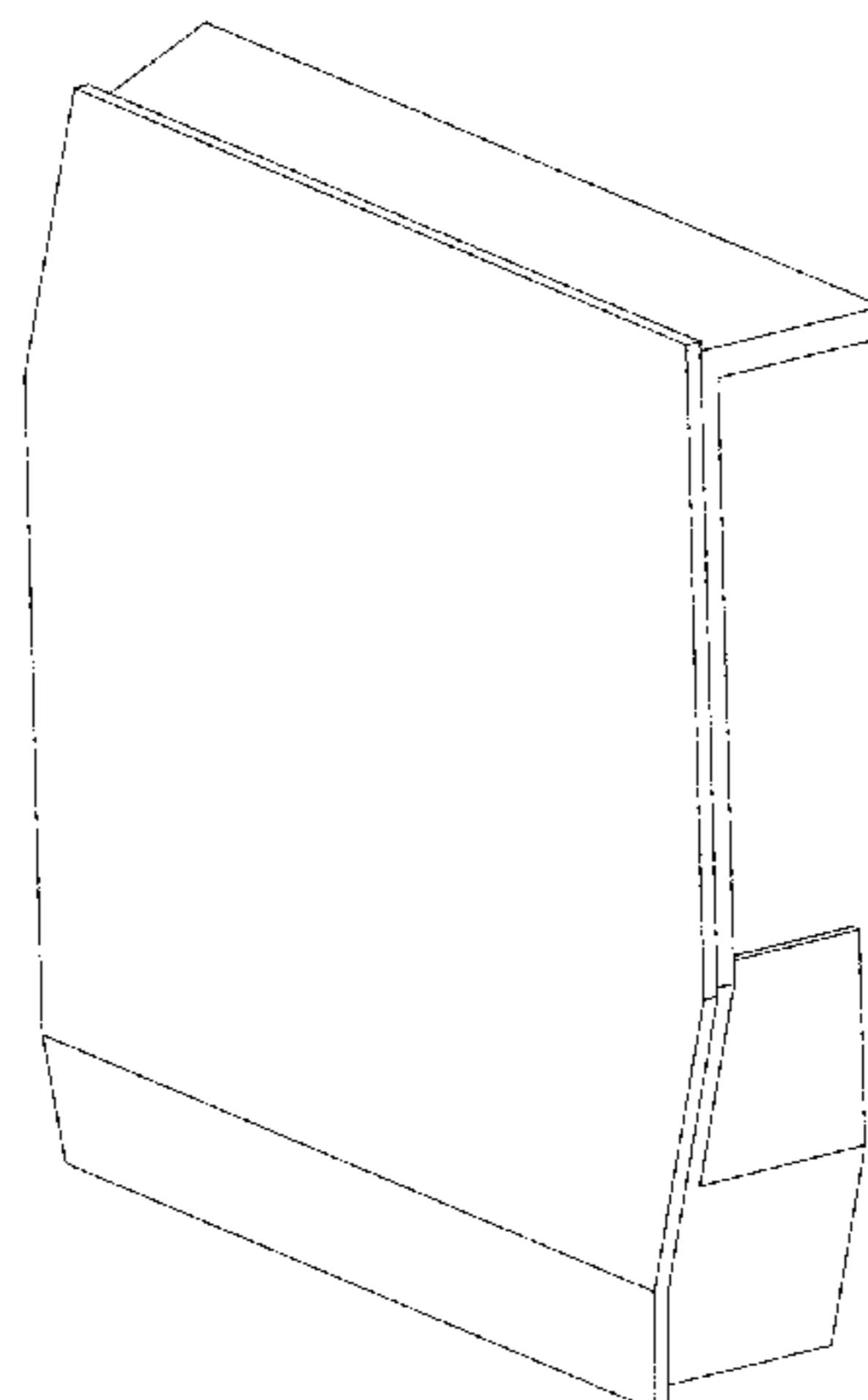
(57) **CLAIM**

The ornamental design for fitting for furniture, as shown and described.

**DESCRIPTION**

FIG. 1 shows a front perspective view of a first embodiment of a fitting for furniture;  
FIG. 2 shows a rear perspective view thereof;  
FIG. 3 shows a front view thereof;  
FIG. 4 shows a top view thereof;  
FIG. 5 shows a bottom view thereof;  
FIG. 6 shows a right side view thereof;  
FIG. 7 shows a left side view thereof;  
FIG. 8 shows a back view thereof;  
FIG. 9 shows a front perspective view of a second embodiment of a fitting for furniture;  
FIG. 10 shows a rear perspective view thereof;  
FIG. 11 shows a front view thereof;  
FIG. 12 shows a top view thereof;  
FIG. 13 shows a bottom view thereof;  
FIG. 14 shows a right side view thereof;  
FIG. 15 shows a left side view thereof; and,  
FIG. 16 shows a back view thereof.

**1 Claim, 16 Drawing Sheets**



(56)

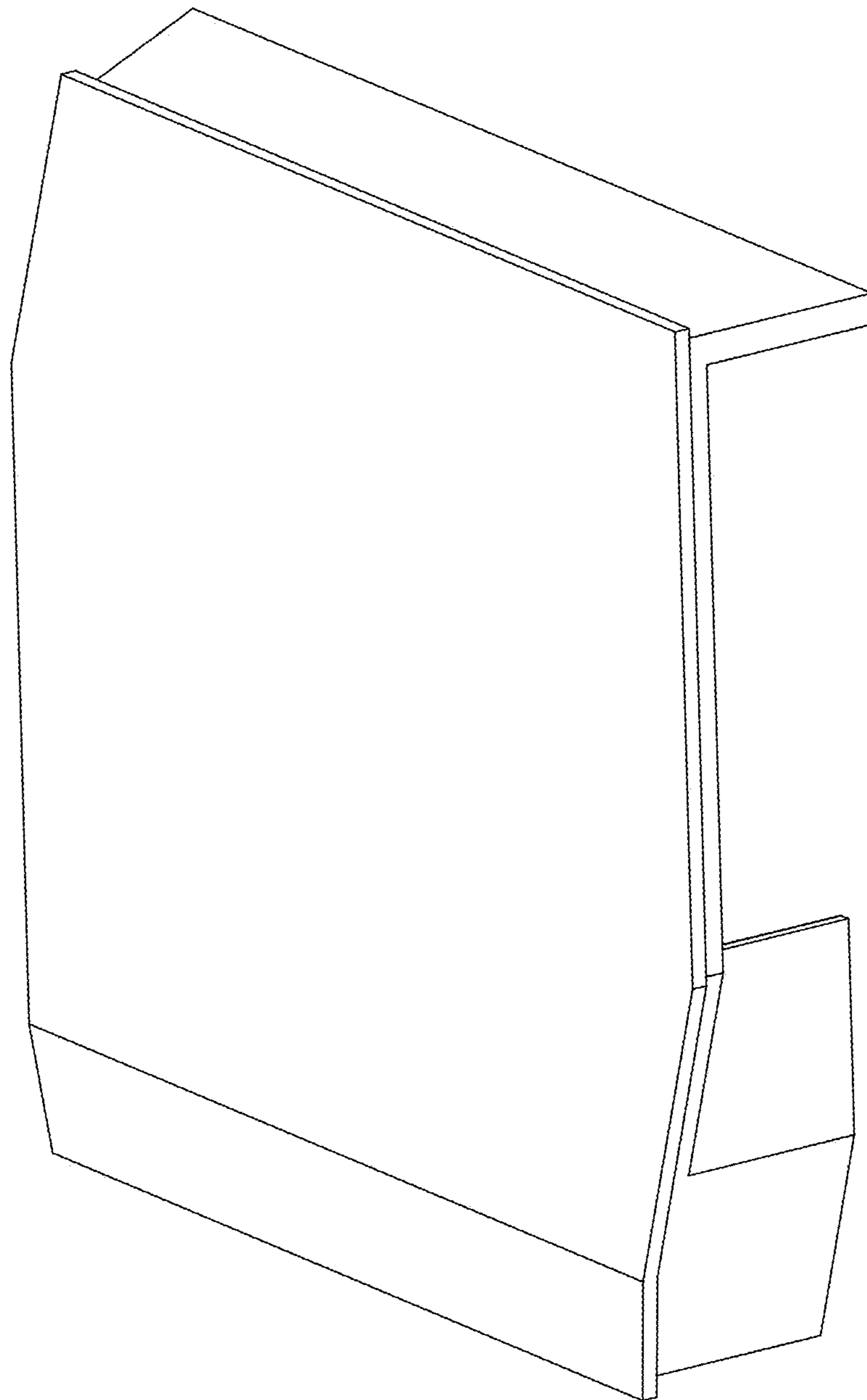
**References Cited**

U.S. PATENT DOCUMENTS

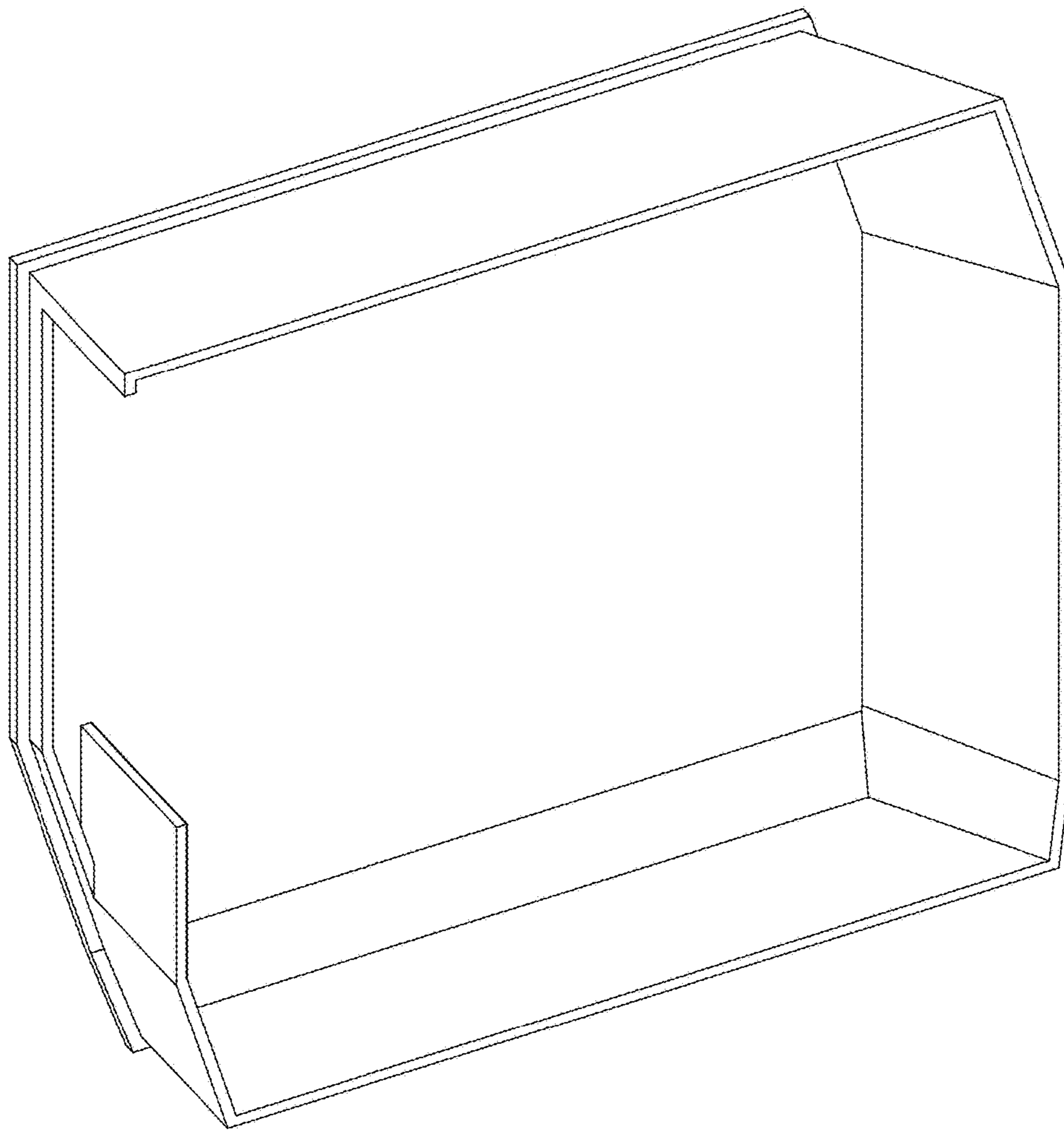
D859,043 S \* 9/2019 Maager ..... D6/702  
2001/0015399 A1 \* 8/2001 LaMotte ..... G09F 15/0025  
248/165

\* cited by examiner

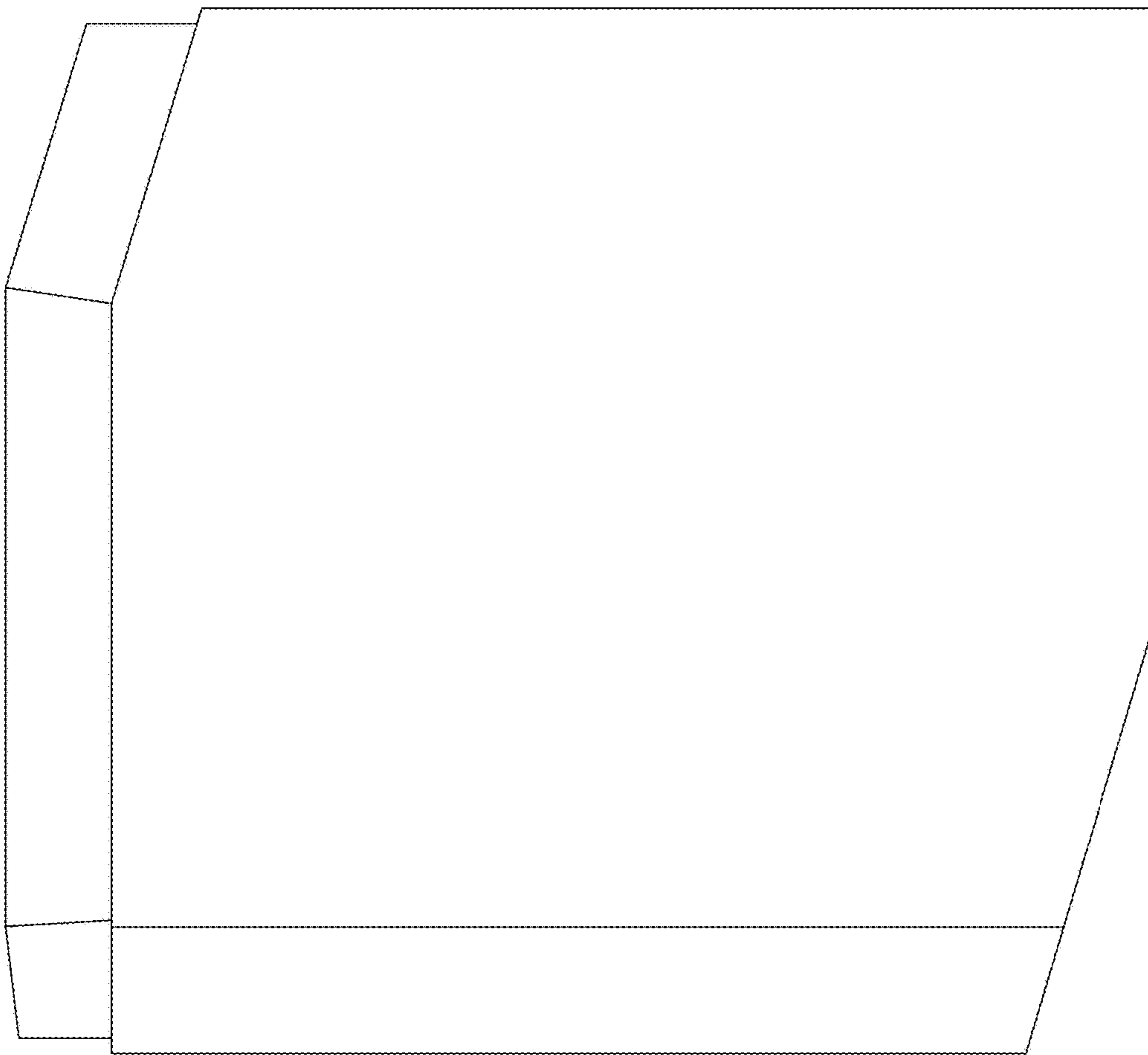
*Fig. 1*



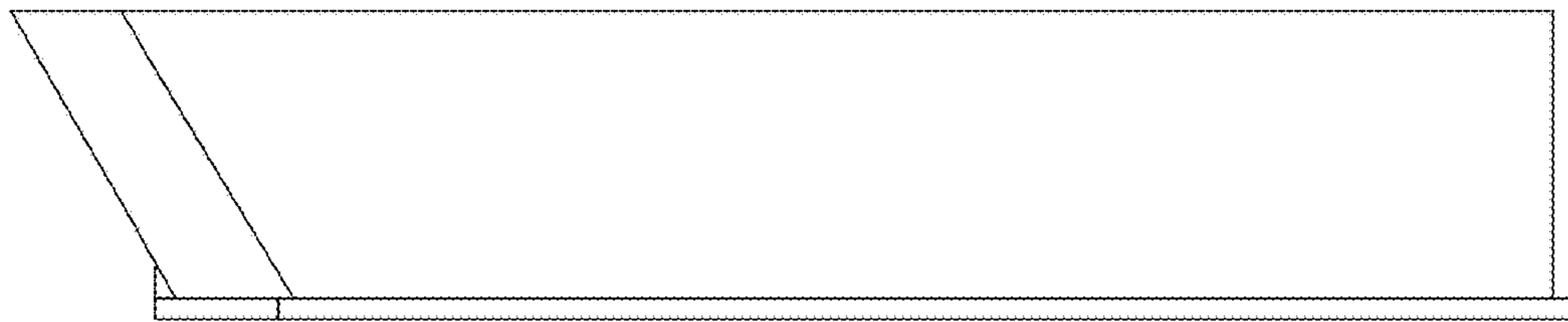
*Fig. 2*



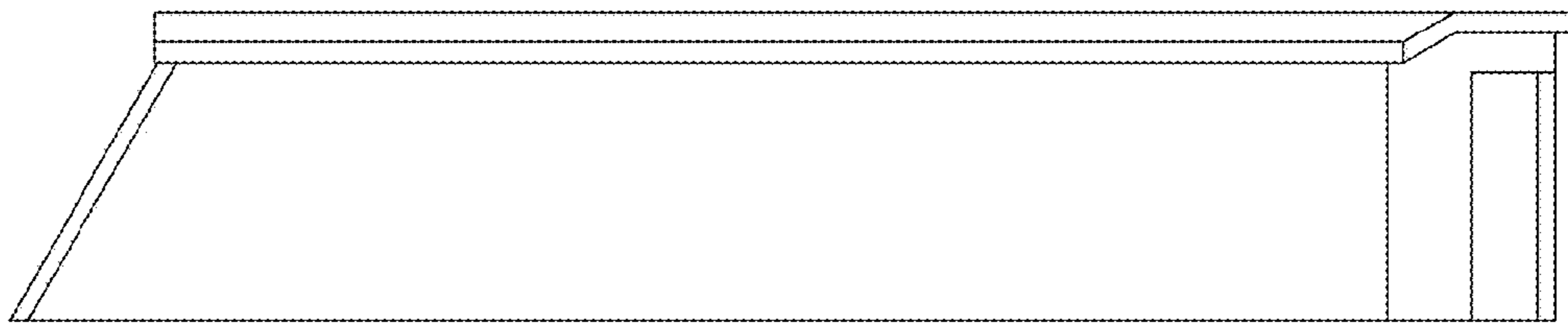
*Fig. 3*



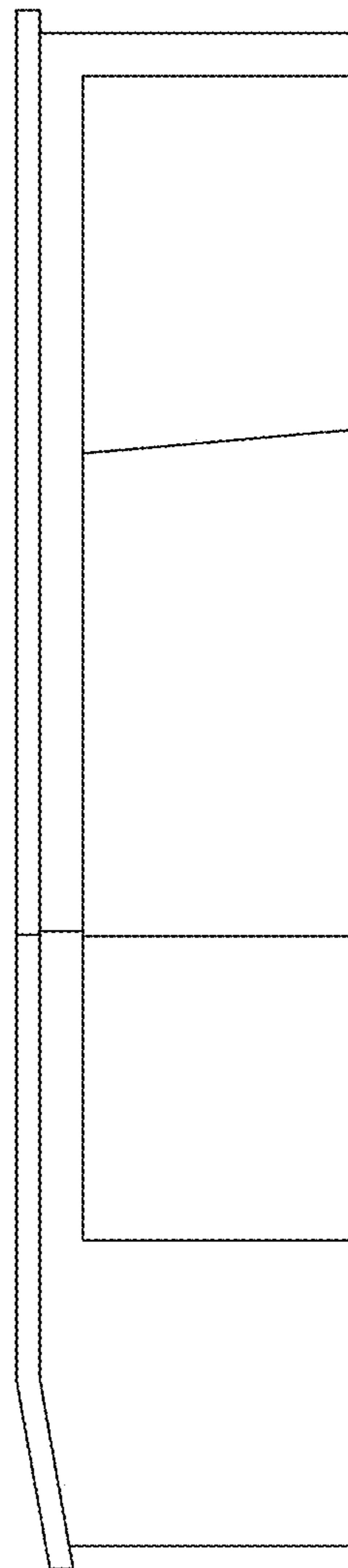
*Fig. 4*



*Fig. 5*

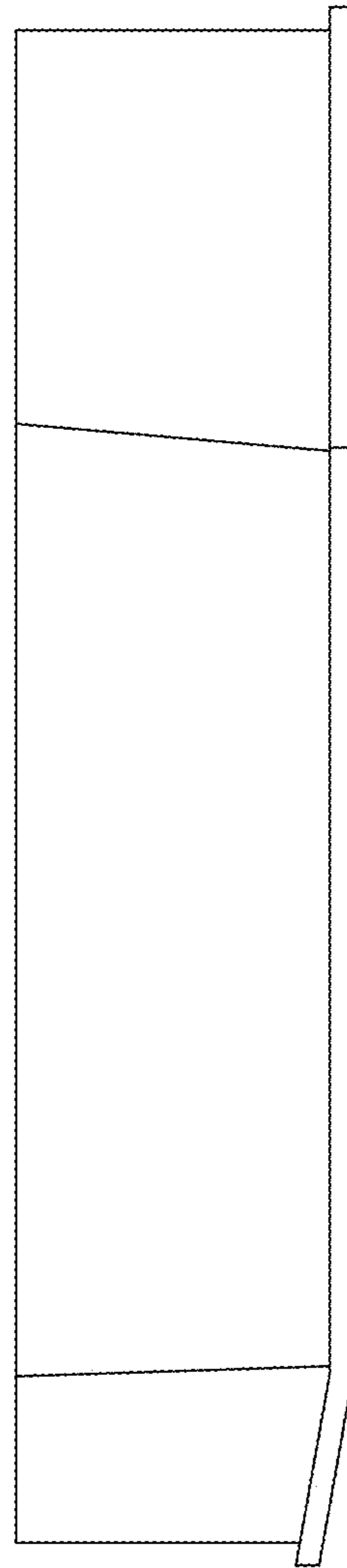


*Fig. 6*

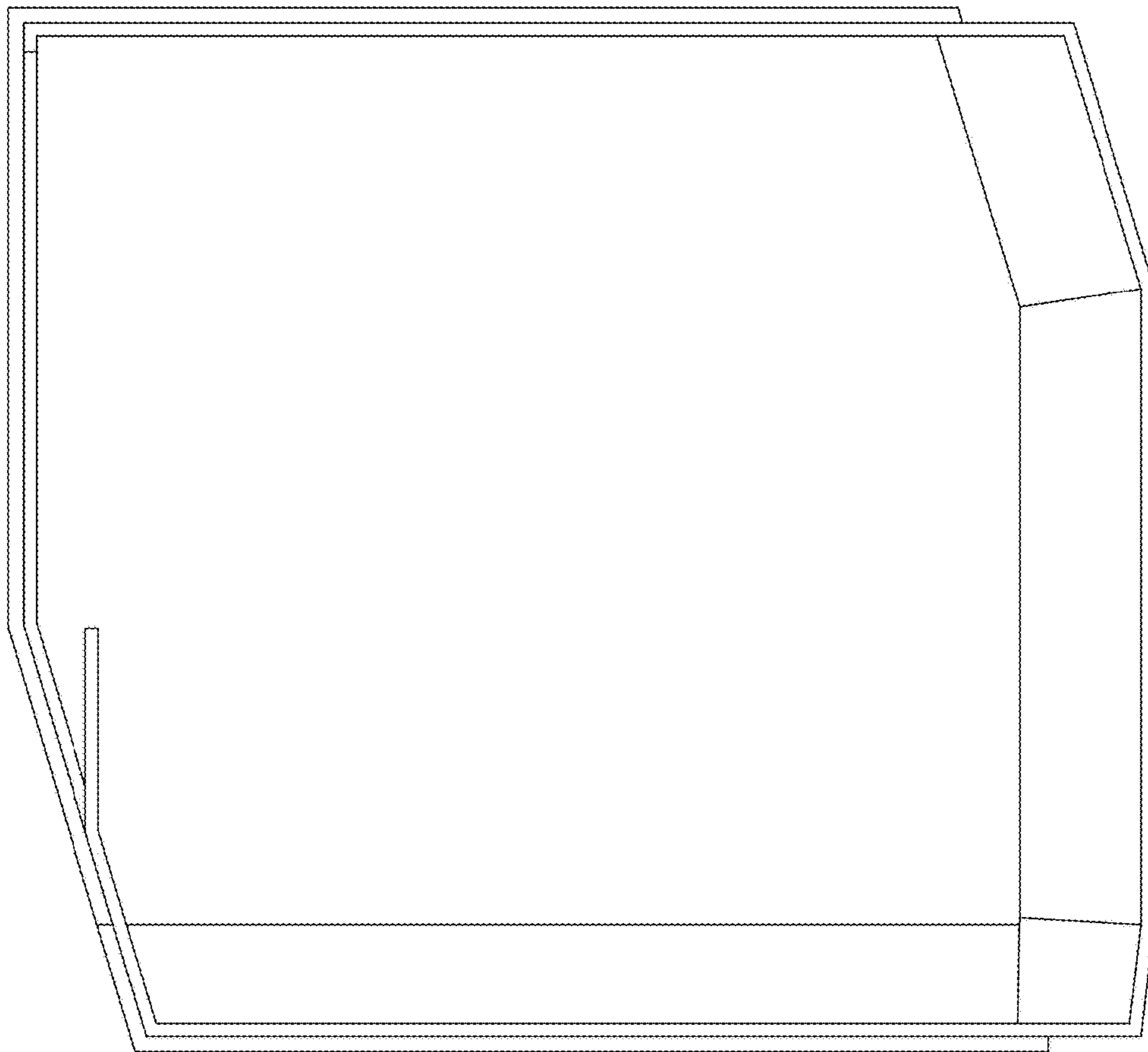




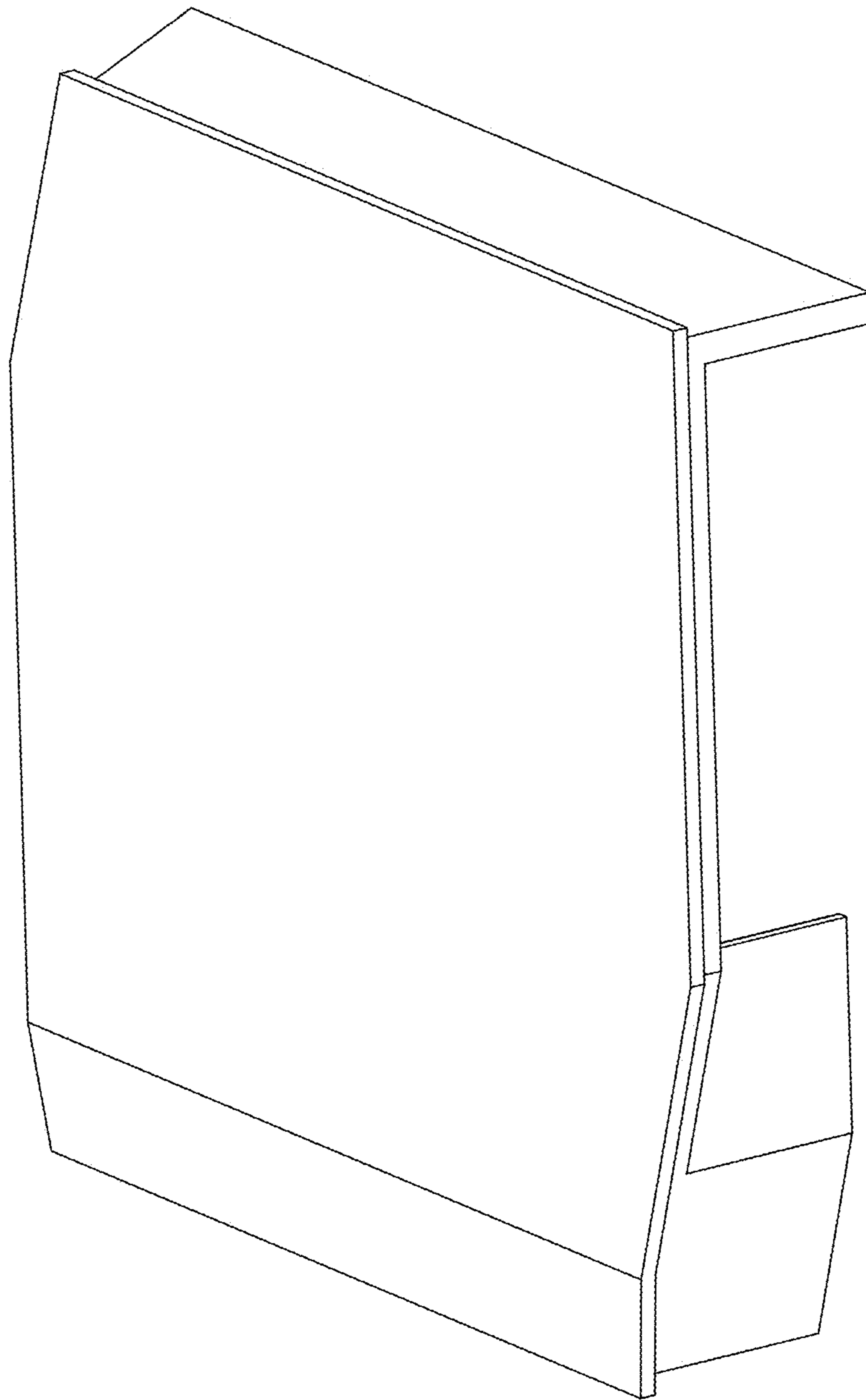
*Fig. 7*



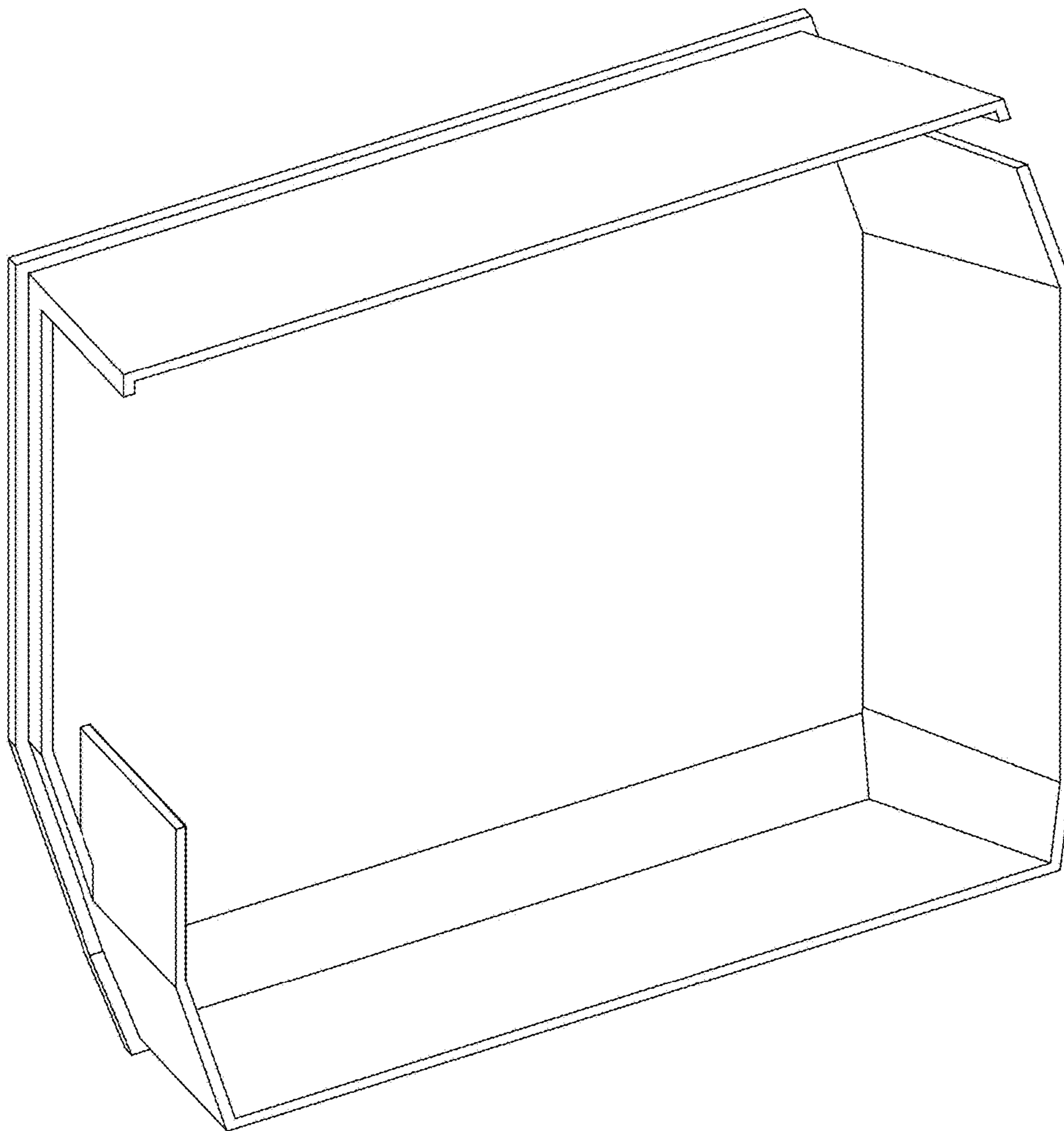
*Fig. 8*



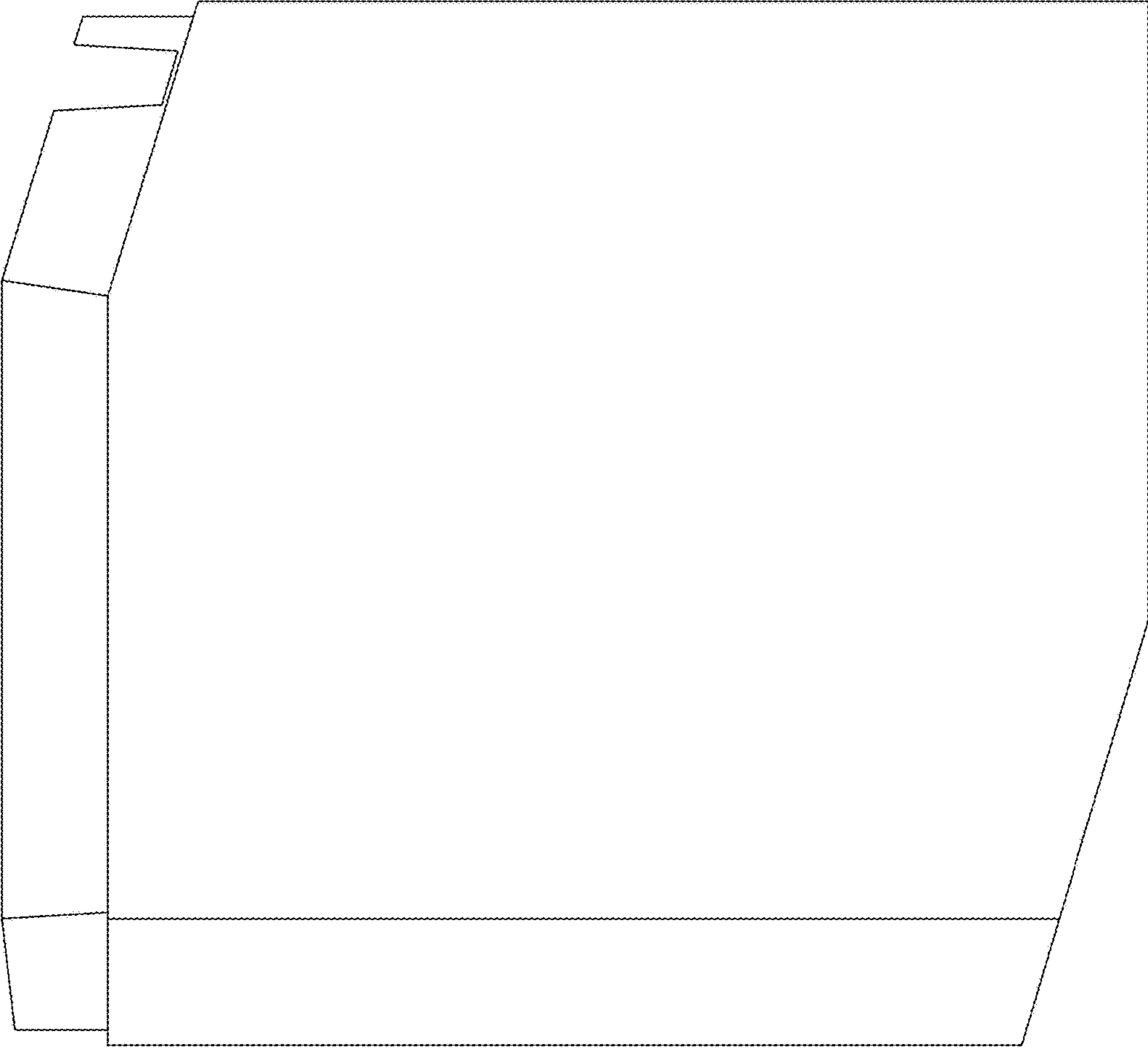
*Fig. 9*



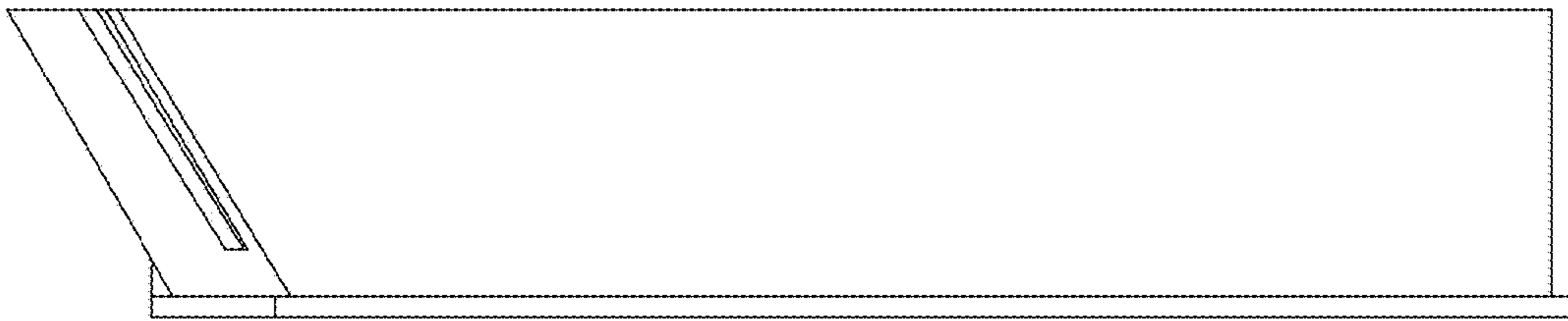
*Fig. 10*



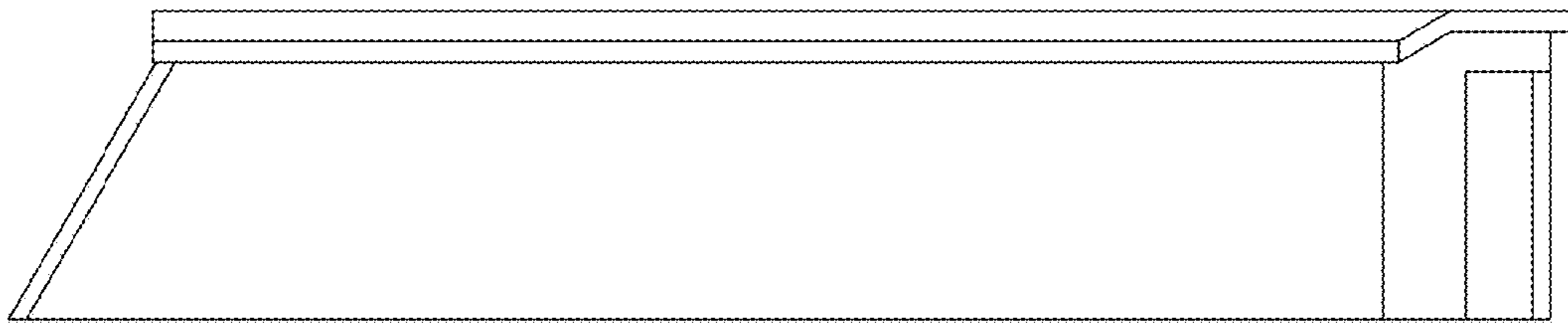
*Fig. 11*



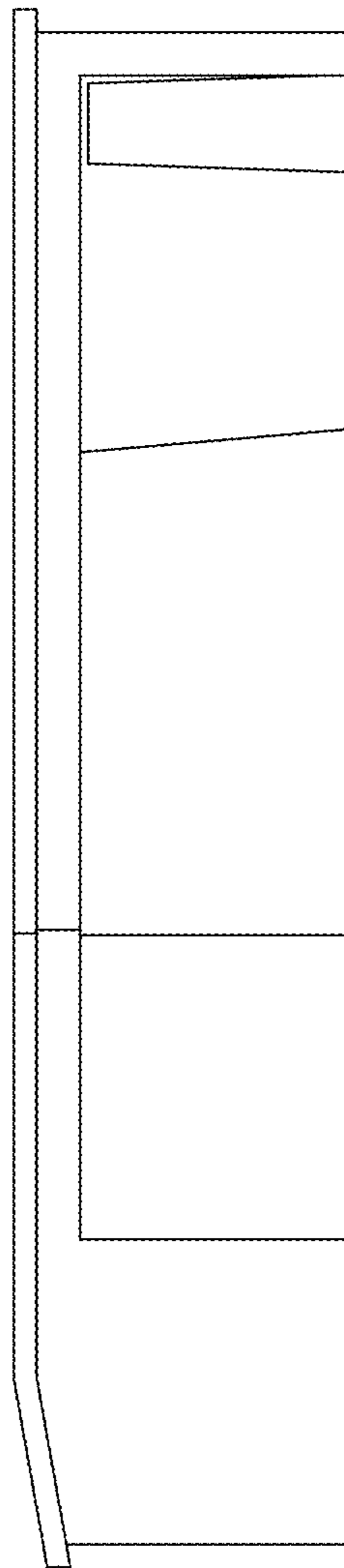
*Fig. 12*



*Fig. 13*

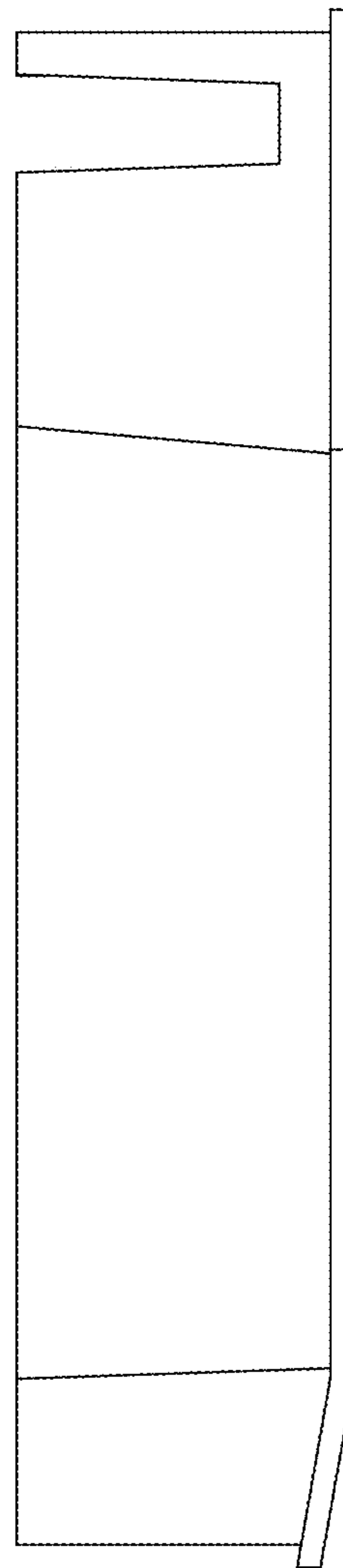


*Fig. 14*





*Fig. 15*



*Fig. 16*

