

US00D869169S

(12) **United States Design Patent** (10) **Patent No.:** **US D869,169 S**  
**Sohn** (45) **Date of Patent:** **\*\* Dec. 10, 2019**

- (54) **ELECTRIC TOOTHBRUSH** D510,810 S \* 10/2005 Berde ..... D4/101  
6,955,539 B2 \* 10/2005 Shortt ..... A61C 17/34  
132/322
- (71) Applicant: **ONE STAR INTERNATIONAL CO., LTD.**, Yeonsu-Gu, Incheon (KR) D545,569 S \* 7/2007 Chen ..... D4/101  
7,269,872 B2 \* 9/2007 Fattori ..... A46B 13/02  
15/167.1
- (72) Inventor: **Jae-Hoon Sohn**, Incheon (KR) D589,261 S \* 3/2009 Nanda ..... D4/107  
D658,883 S \* 5/2012 Winkler ..... D4/101
- (73) Assignee: **One Star International Co., Ltd.**, Incheon (KR) D690,516 S \* 10/2013 Erskine-Smith ..... D4/104  
8,572,794 B2 \* 11/2013 Pate ..... A46B 9/045  
15/167.1
- (\*\*) Term: **15 Years** D694,524 S \* 12/2013 Erskine-Smith ..... D4/104  
D702,947 S \* 4/2014 Lee ..... D4/101
- (21) Appl. No.: **35/505,068** D706,034 S \* 6/2014 Blachford ..... D4/107  
D747,882 S \* 1/2016 Blachford ..... D4/107
- (22) Filed: **Dec. 7, 2017** D765,414 S \* 9/2016 Sosa ..... D4/101  
D778,057 S \* 2/2017 Sohn ..... D4/101  
D780,455 S \* 3/2017 Kandemir ..... D4/101
- (80) **Hague Agreement Data** D827,306 S \* 9/2018 Sabet ..... D4/103  
D829,019 S \* 9/2018 Sohn ..... D6/534

(Continued)

Int. Filing Date: **Dec. 7, 2017**  
Int. Reg. No.: **DM/099594**  
Int. Reg. Date: **Dec. 7, 2017**  
Int. Reg. Pub. Date: **Jun. 8, 2018**

*Primary Examiner* — Rhea Shields  
(74) *Attorney, Agent, or Firm* — Knobbe Martens Olson & Bear LLP

(30) **Foreign Application Priority Data**

Jun. 16, 2017 (KR) ..... 30-2017-0027731

(51) **LOC (12) Cl.** ..... **04-02**

(52) **U.S. Cl.**  
USPC ..... **D4/101**

(58) **Field of Classification Search**

USPC ..... D4/100–104, 107–109, 117, 133, 119,  
D4/134, 135, 138; D6/534; D28/25, 55,  
D28/29, 10

CPC ..... A46B 13/02; A46B 9/045; A61C 17/34;  
A61C 17/225

See application file for complete search history.

(56) **References Cited**

U.S. PATENT DOCUMENTS

D453,996 S \* 3/2002 Kling ..... D4/101  
D457,000 S \* 5/2002 Lim ..... D4/104  
D475,533 S \* 6/2003 Cunniffe ..... D4/107

(57) **CLAIM**

The ornamental design for an electric toothbrush, as shown and described.

**DESCRIPTION**

1. Electric toothbrush

1.1 : Perspective

1.2 : Front

1.3 : Back

1.4 : Top

1.5 : Bottom

1.6 : Left

1.7 : Right

This design has been created by the motif of duck.

In the drawings, the broken lines are for the purpose of illustrating environment only and form no part of the claimed design.

**1 Claim, 7 Drawing Sheets**

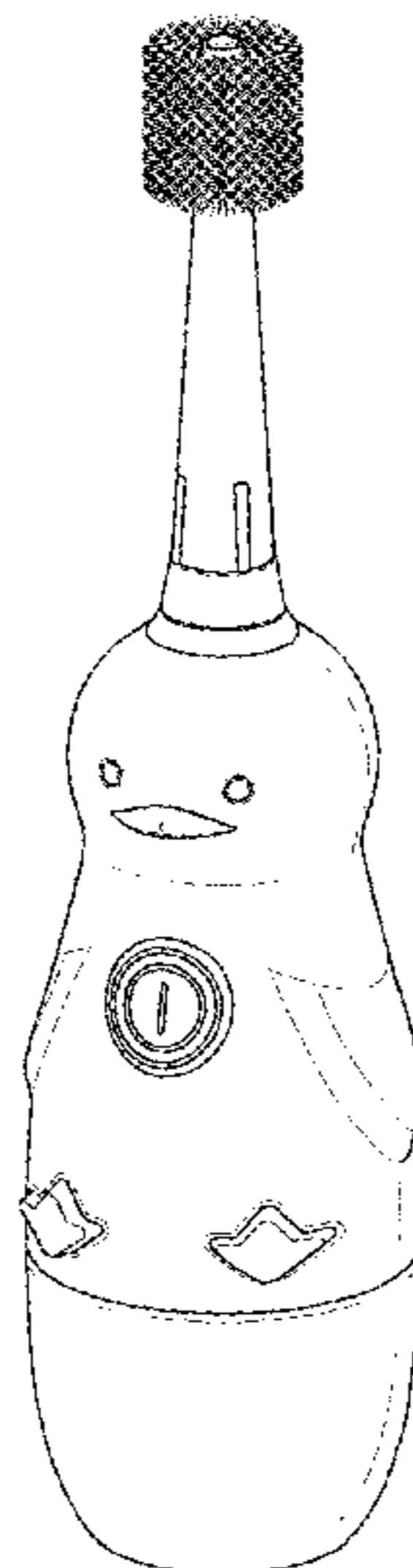

(56)

**References Cited**

U.S. PATENT DOCUMENTS

D834,321	S	*	11/2018	Demarest	.....	D4/100
D834,322	S	*	11/2018	Sohn	.....	D4/101
D834,323	S	*	11/2018	Sohn	.....	D4/101
D840,690	S	*	2/2019	Sedic	.....	D4/101
2003/0213075	A1	*	11/2003	Hui	.....	A61C 17/225 15/22.1

\* cited by examiner

1.1

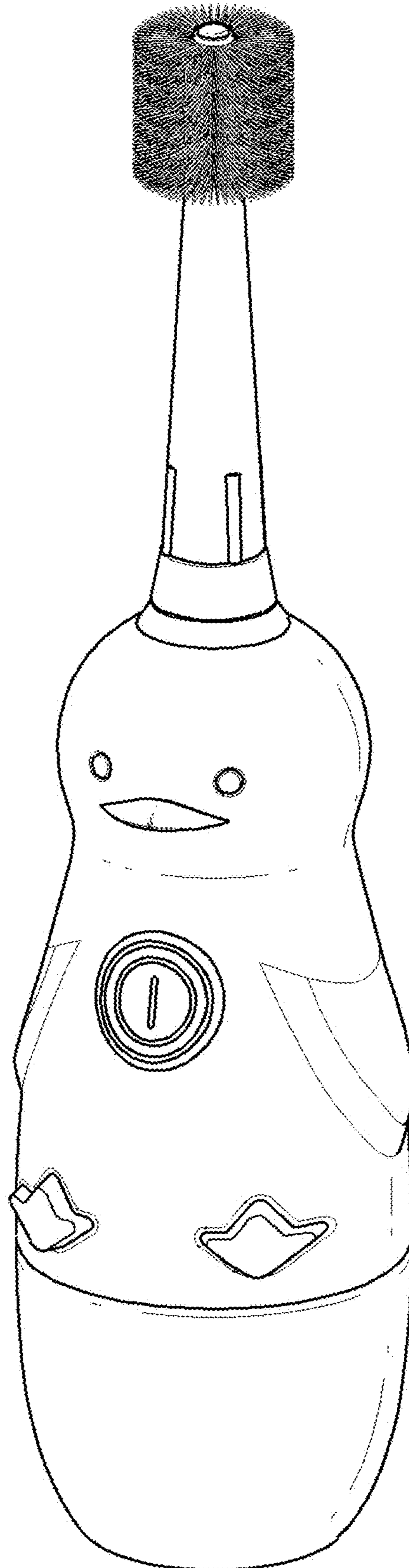

1.2

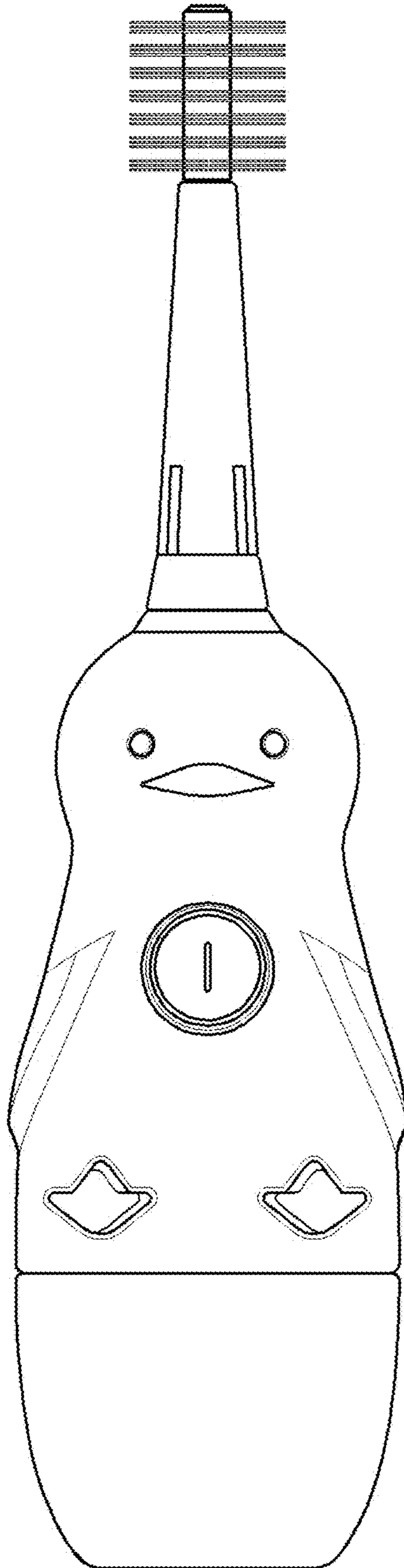

1.3

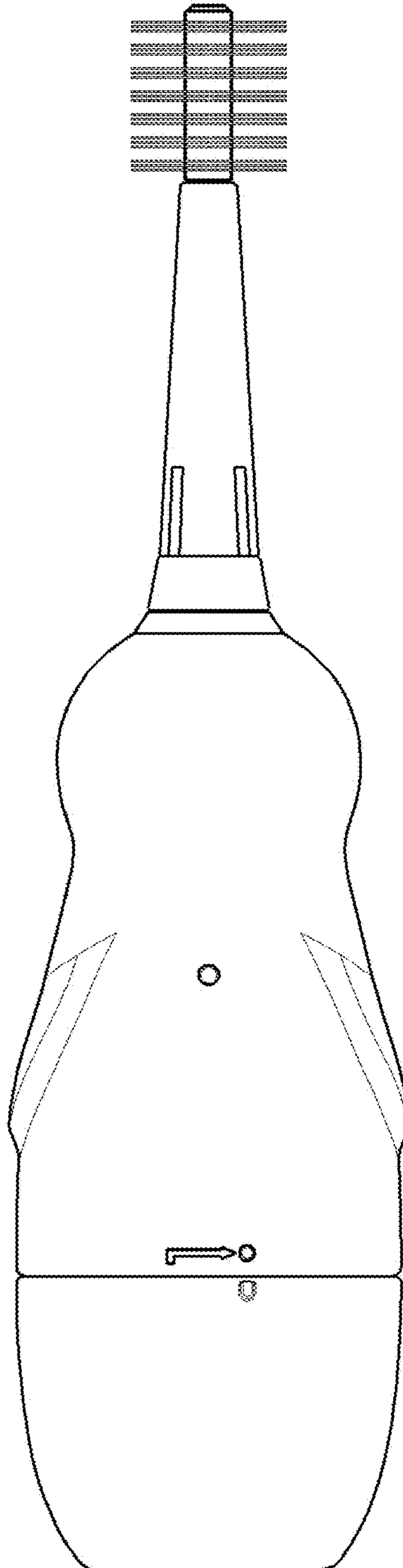

1.4

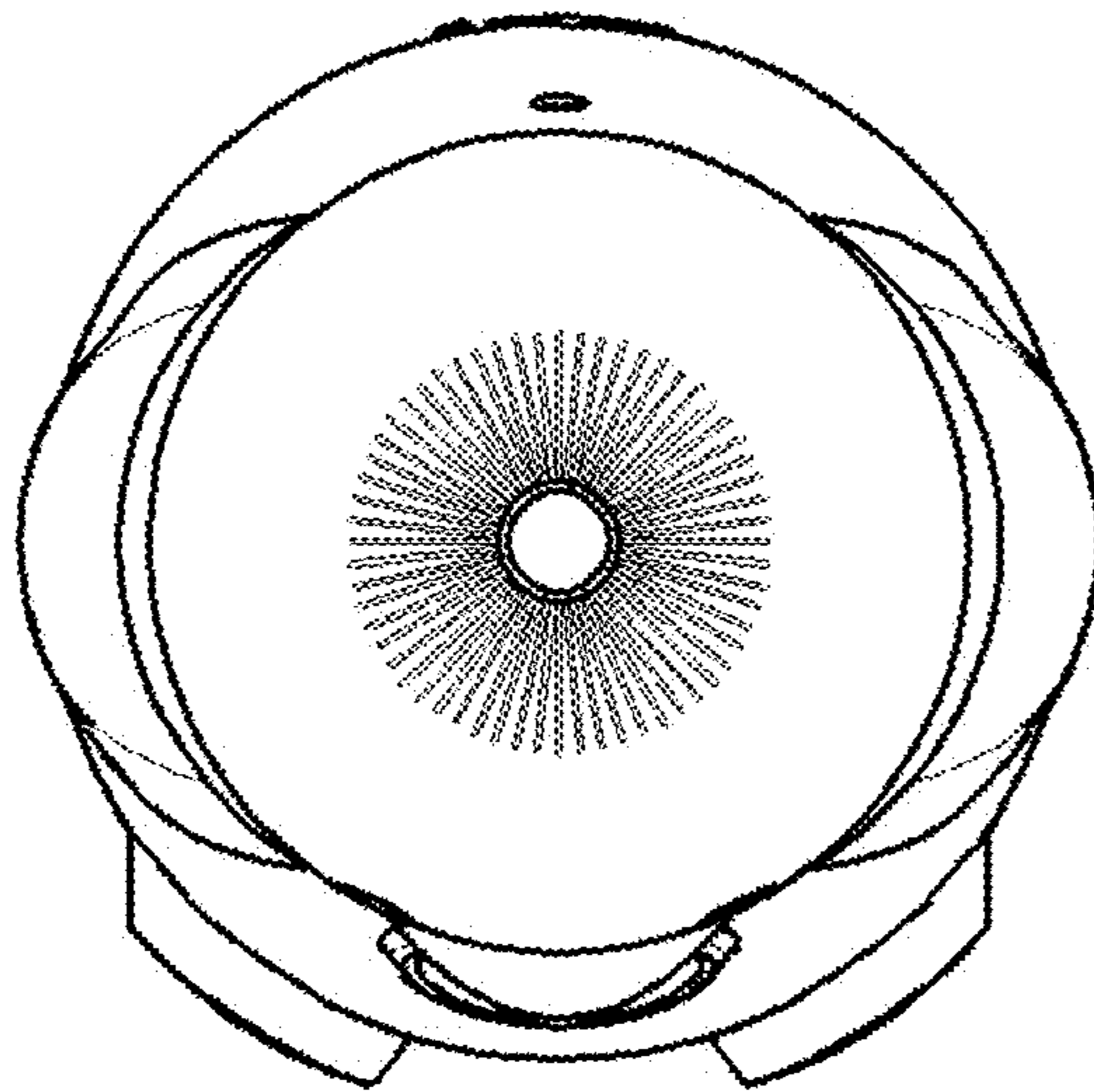

1.5

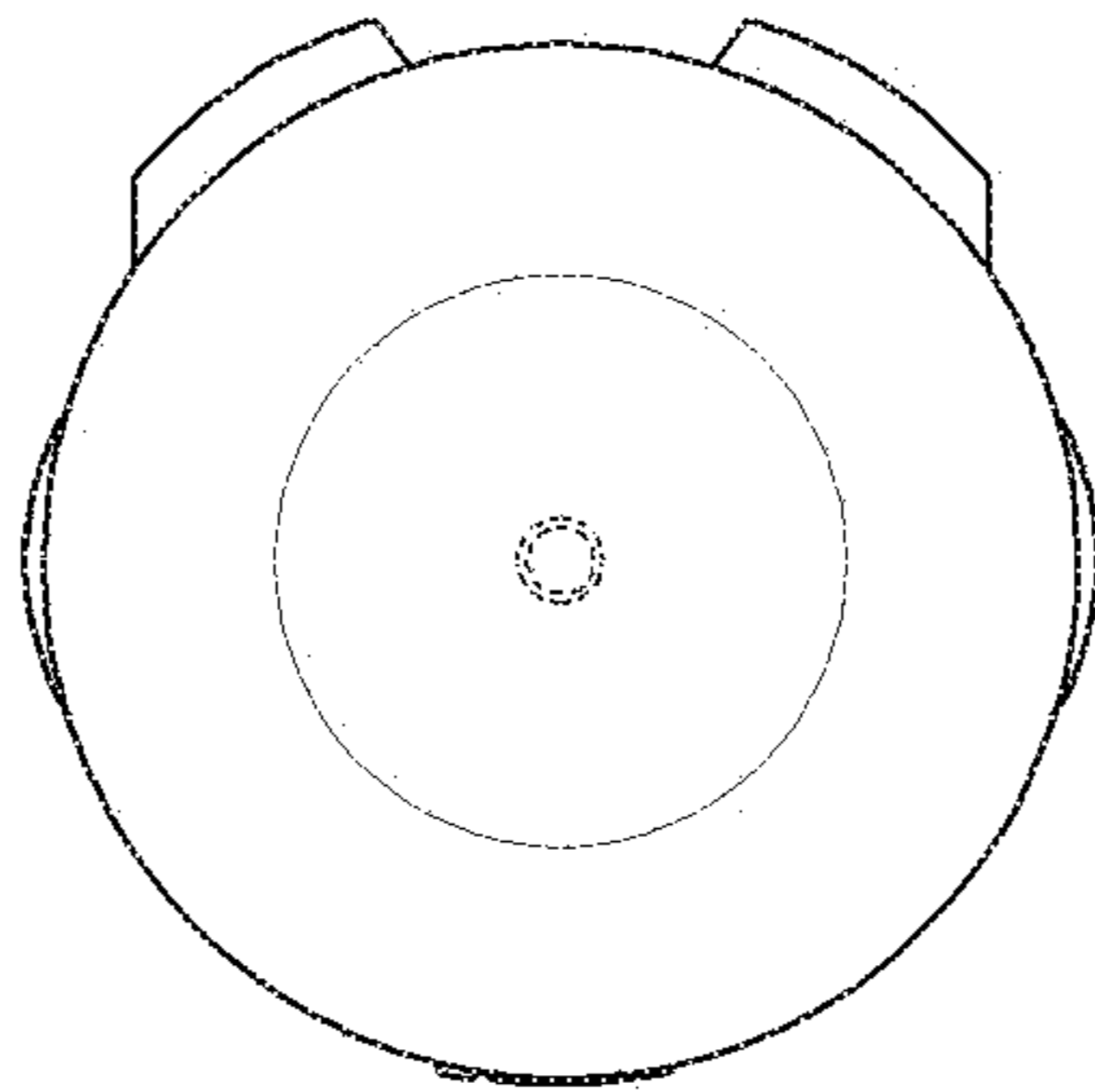



1.6

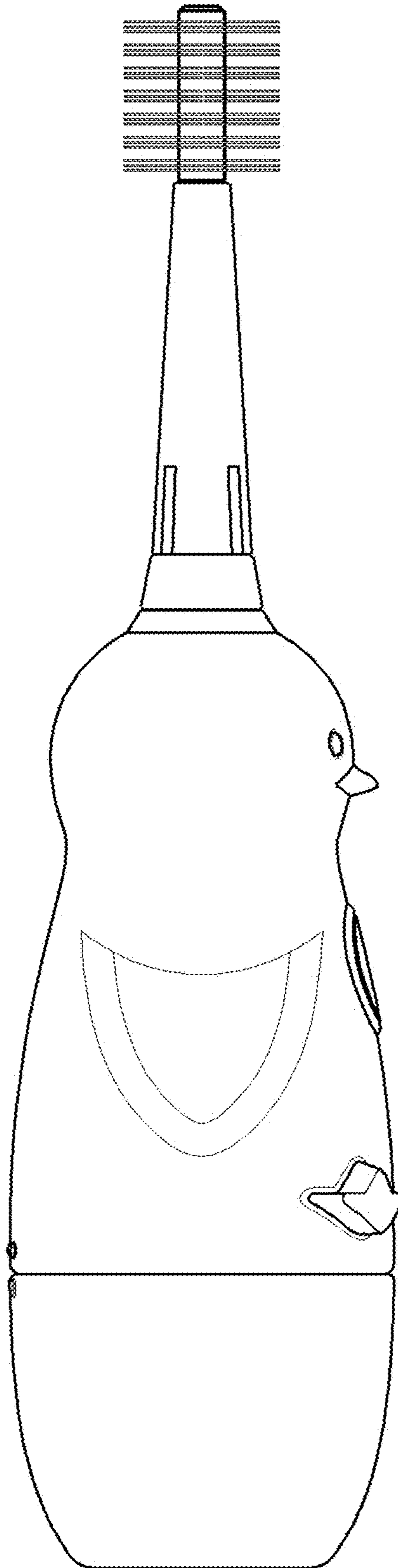



1.7

