

US00D869154S

(12) **United States Design Patent** (10) **Patent No.:** **US D869,154 S**
Zeller (45) **Date of Patent:** **** Dec. 10, 2019**

(54) **HANDBAG**

(71) Applicant: **DELVAUX CREATEUR SA**, Brussels (BE)

(72) Inventor: **Christina Zeller**, Saint-Gilles (BE)

(**) Term: **15 Years**

(21) Appl. No.: **35/503,617**

(22) Filed: **Aug. 11, 2017**

(80) **Hague Agreement Data**

Int. Filing Date: **Aug. 11, 2017**

Int. Reg. No.: **DM/097405**

Int. Reg. Date: **Aug. 11, 2017**

Int. Reg. Pub. Date: **Sep. 1, 2017**

(30) **Foreign Application Priority Data**

Feb. 15, 2017 (EM) 003754746

(51) **LOC (12) Cl.** **03-01**

(52) **U.S. Cl.**
USPC **D3/232**

(58) **Field of Classification Search**
USPC D3/201, 217, 232-233, 240-243,
D3/245-247, 249-253, 318, 321, 322
CPC A45C 1/024; A45C 3/06
See application file for complete search history.

(56) **References Cited**

U.S. PATENT DOCUMENTS

D419,763 S *	2/2000	Wiebe	D3/232
D633,713 S *	3/2011	Bode	D3/232
D723,267 S *	3/2015	Basha	D3/232
D725,900 S *	4/2015	McCue	D3/232
D818,703 S *	5/2018	Guyon	D3/232
D828,999 S *	9/2018	Philo	D3/232
D831,344 S *	10/2018	Zeller	D3/232

* cited by examiner

Primary Examiner — Holly E Thurman

(57) **CLAIM**

The ornamental design for a handbag, as shown and described.

DESCRIPTION

1. Handbags

Figure 1.1 is a perspective view of a handbag showing our new design;

Figure 1.2 is another perspective view thereof;

Figure 1.3 is a front elevational view thereof;

Figure 1.4 is a left side elevational view thereof;

Figure 1.5 is a right side elevational view thereof; and

Figure 1.6 is a top plan view thereof.

The broken lines in Figure 1.1 are included to show portions of the article which form no part of the claimed design.

1 Claim, 6 Drawing Sheets

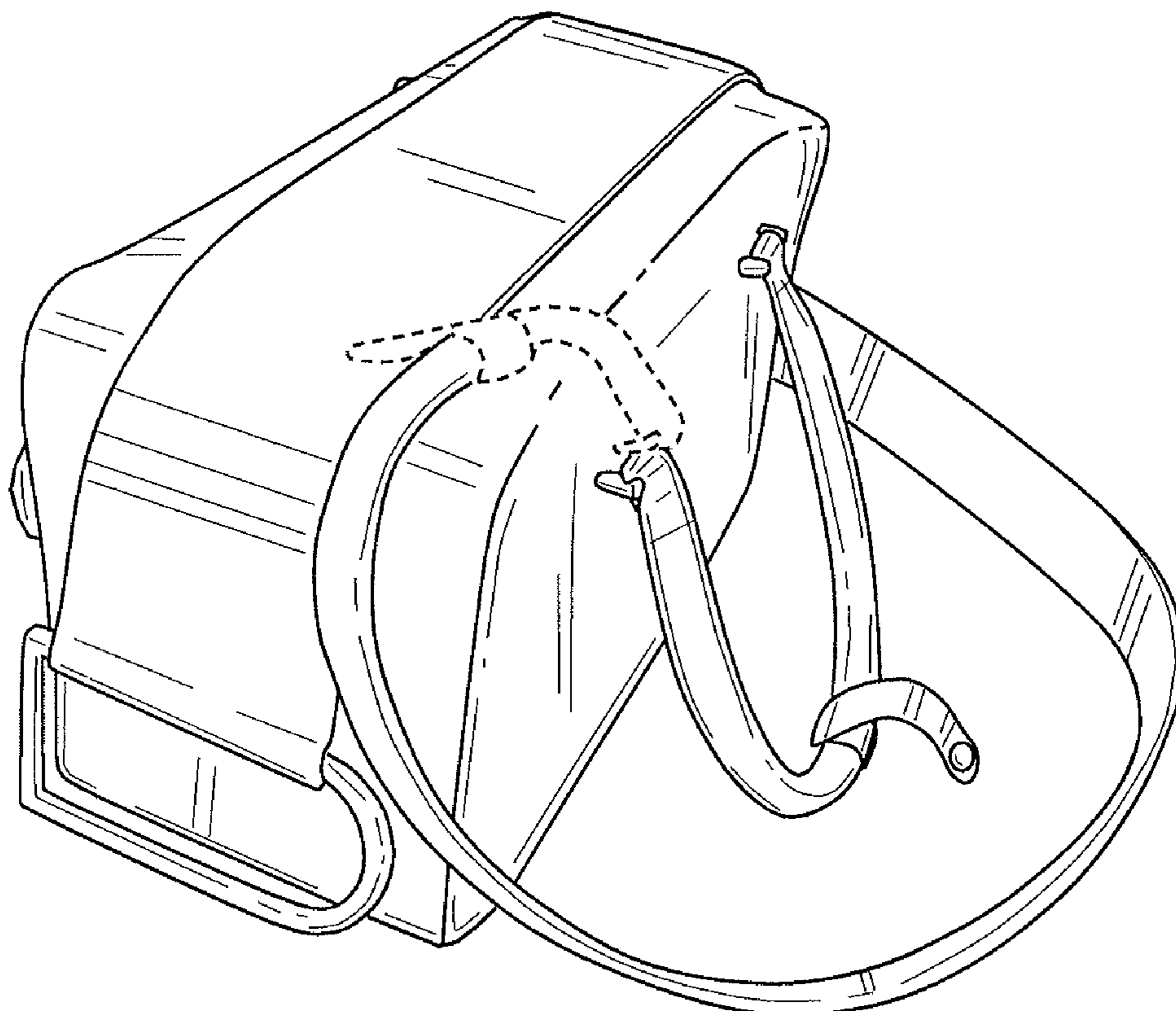

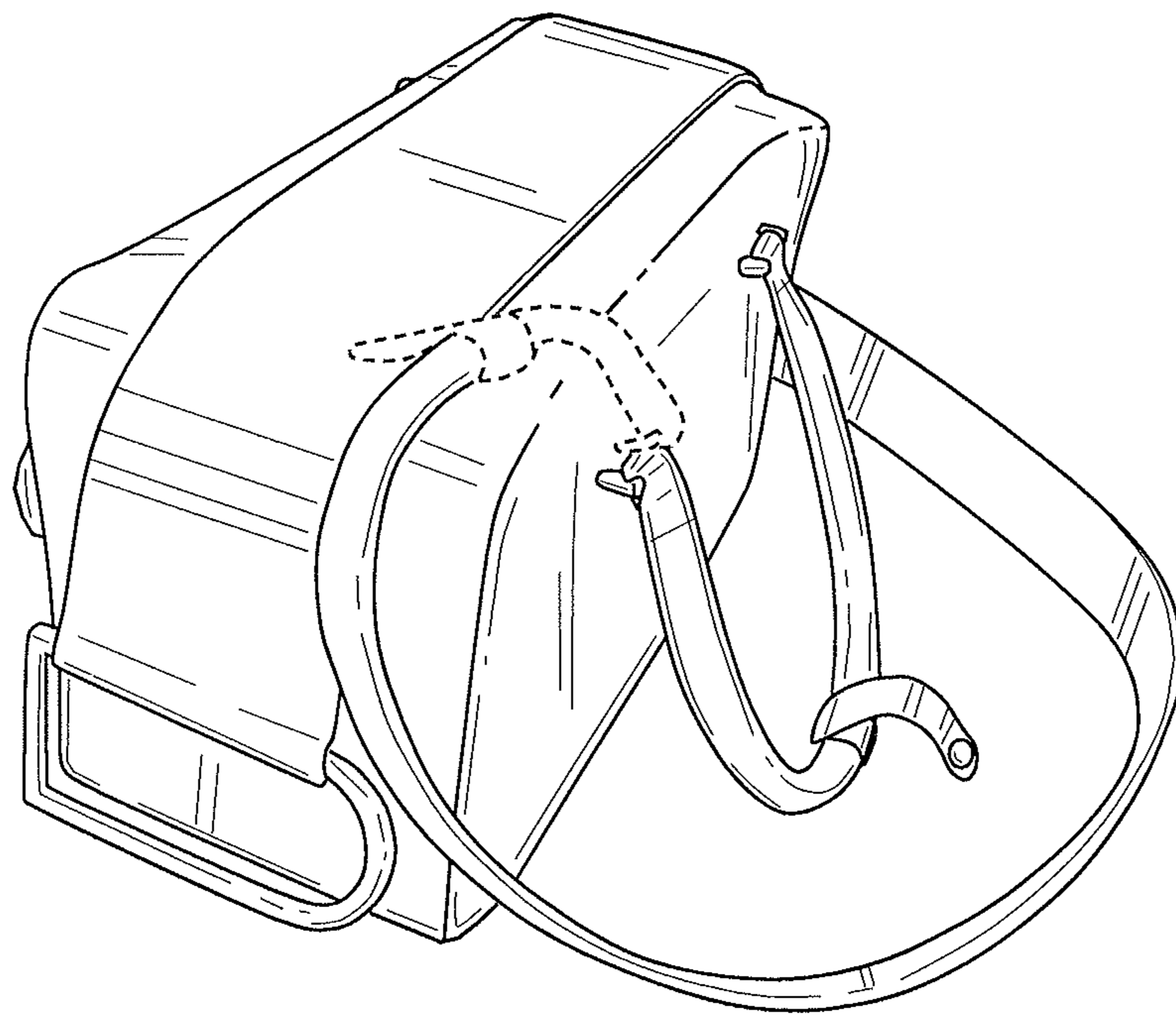

FIG. 1.1

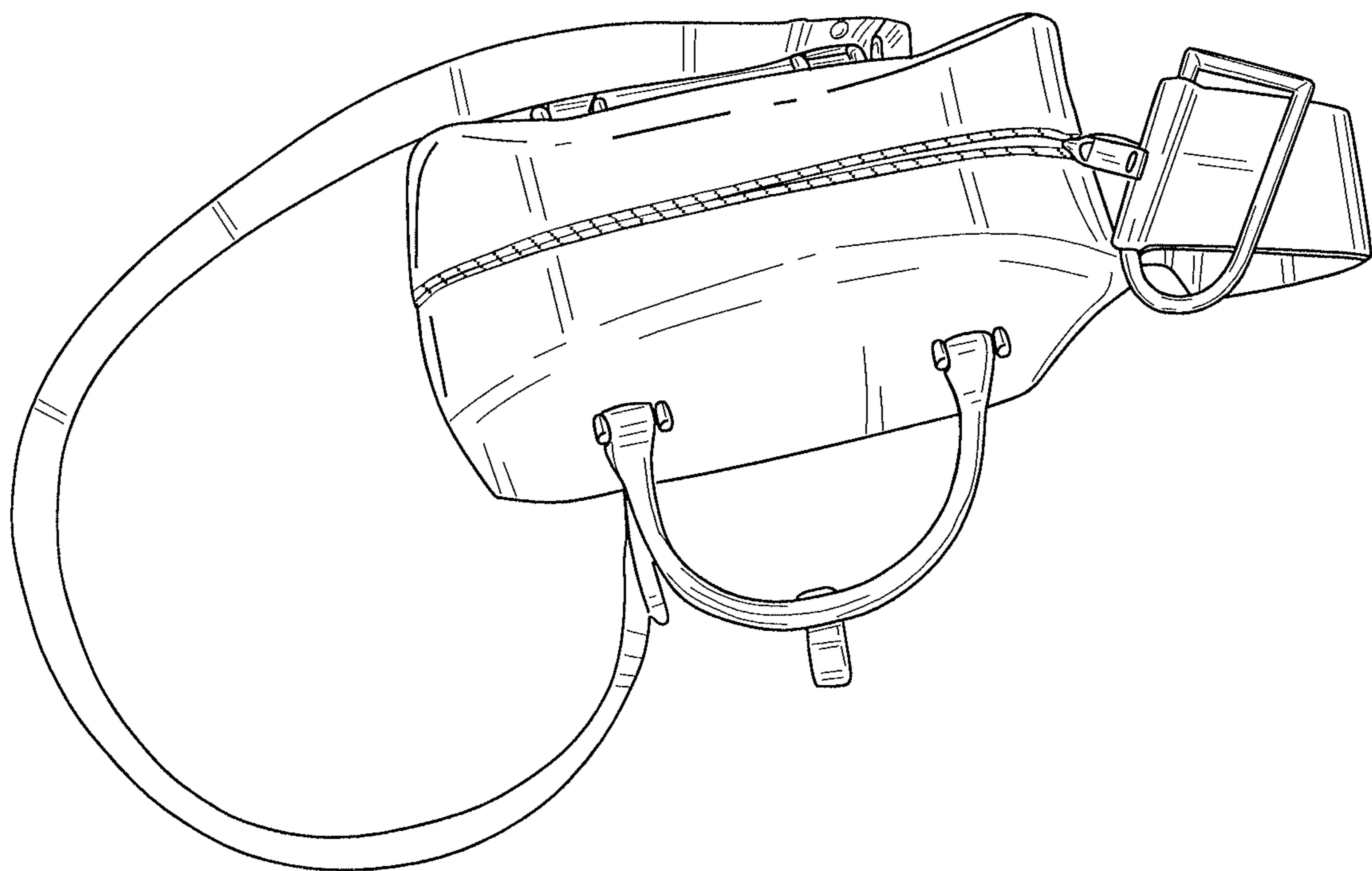

FIG. 1.2

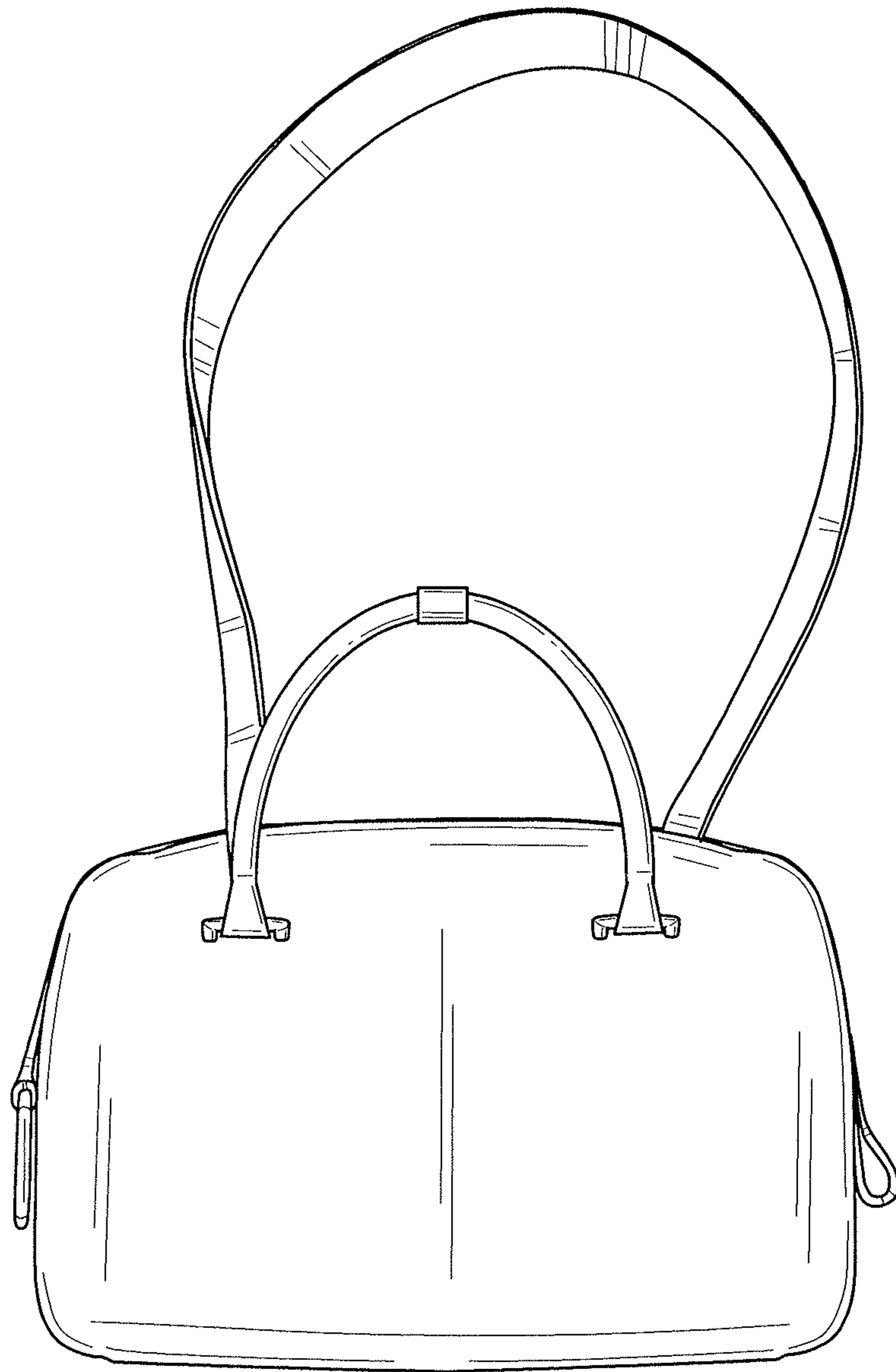

FIG. 1.3

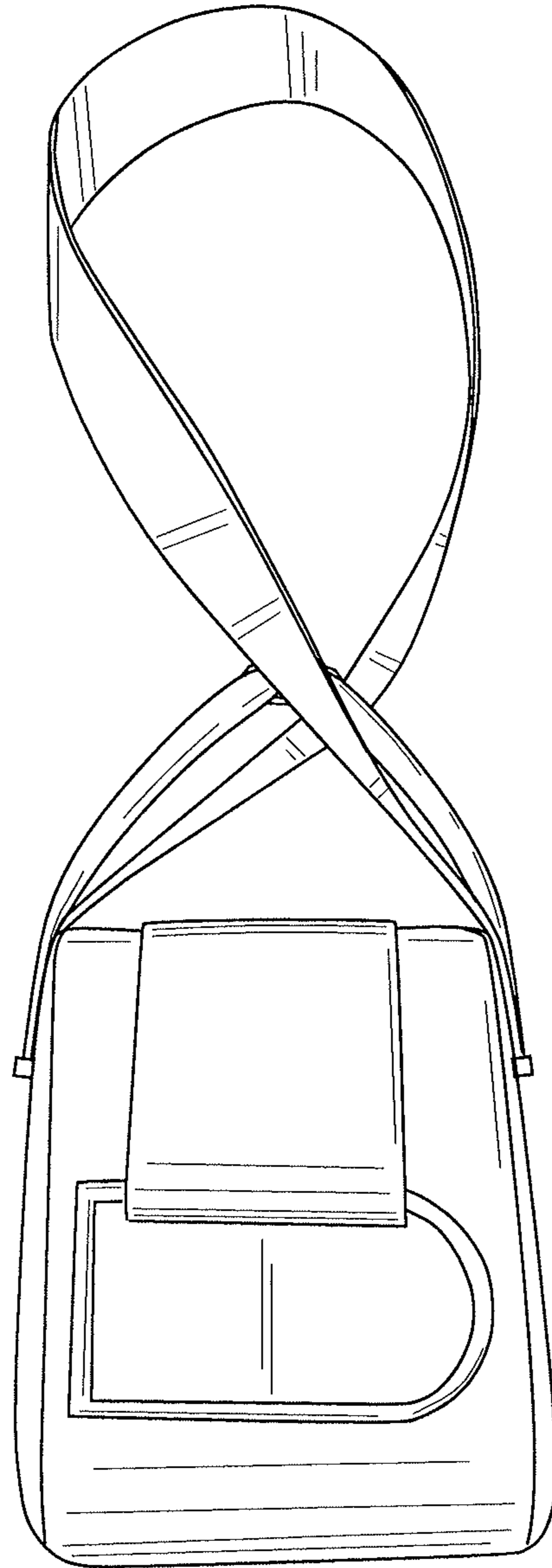

FIG. 1.4

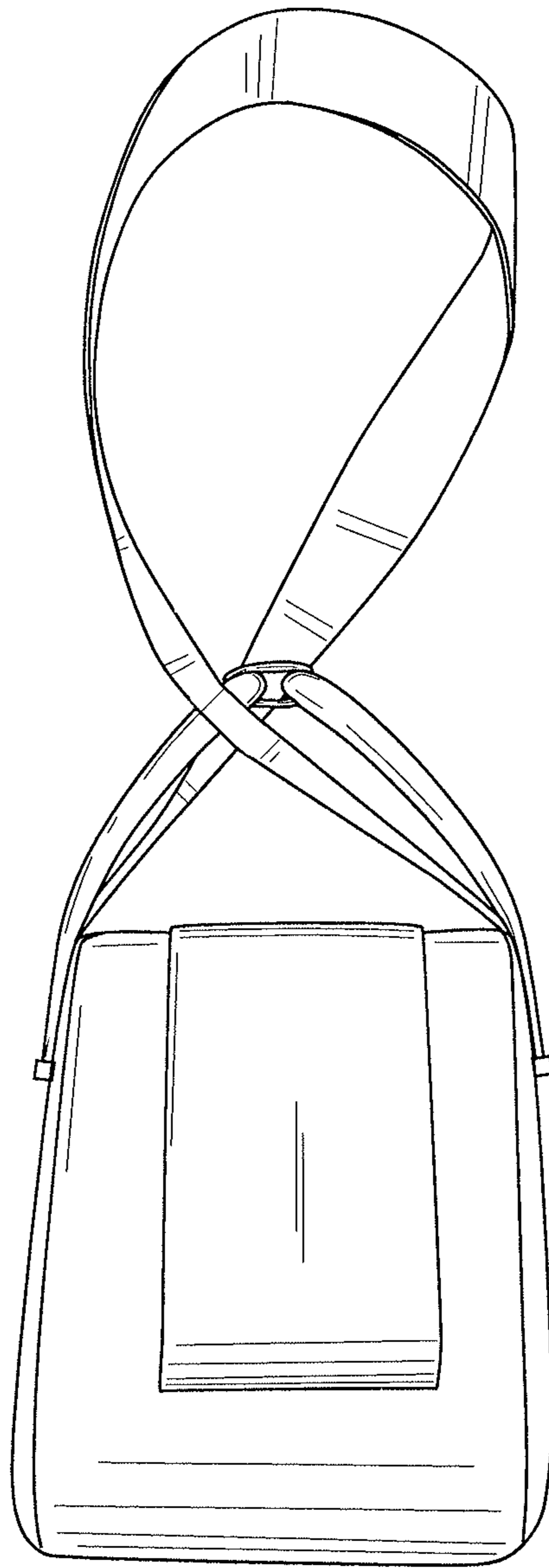

FIG. 1.5

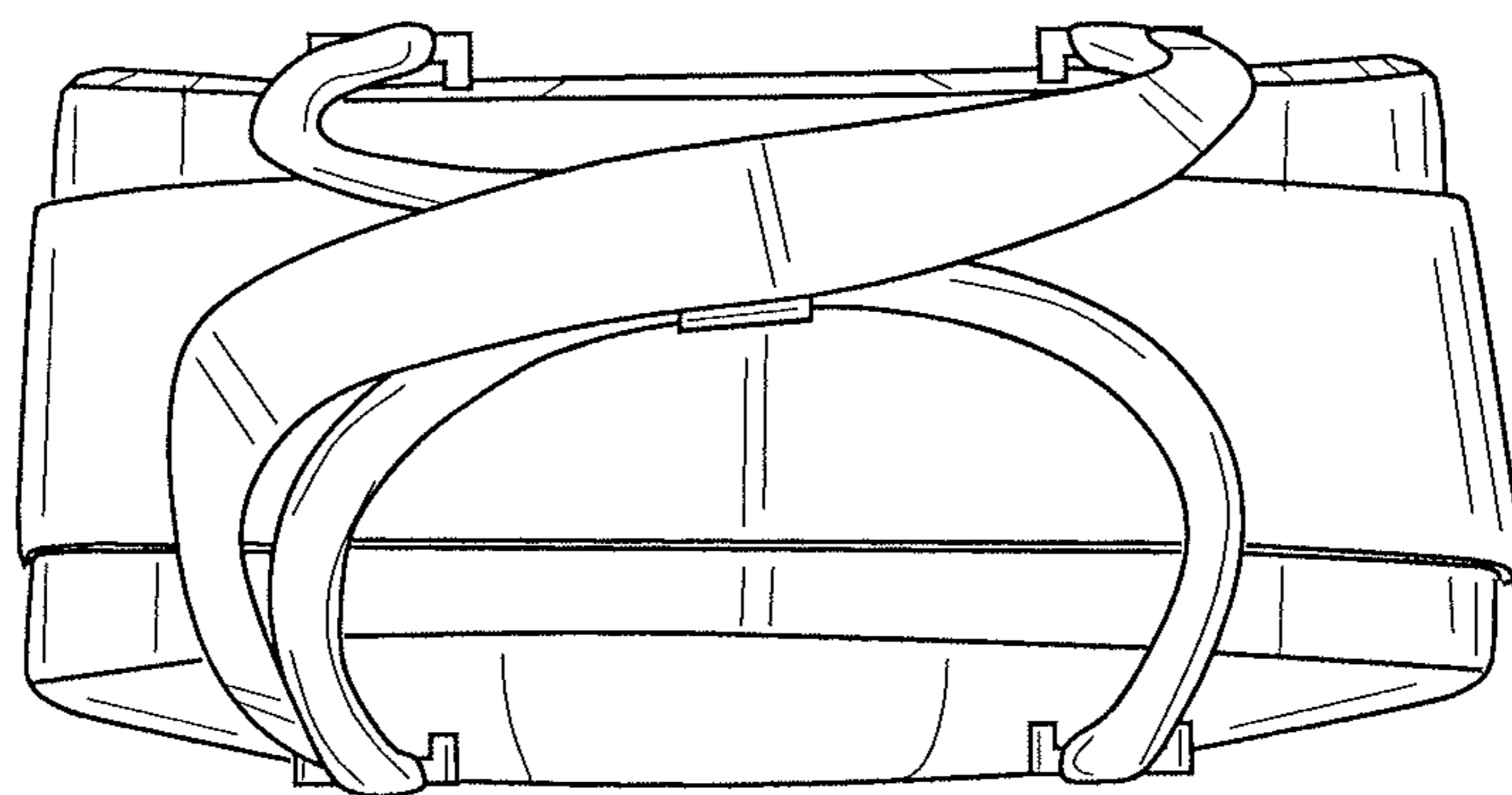

FIG. 1.6