



US00D869145S

(12) **United States Design Patent**
Luo

(10) **Patent No.:** **US D869,145 S**

(45) **Date of Patent:** **** Dec. 10, 2019**

(54) **SHOELACE**

(71) Applicant: **Ai Luo**, Guangdong (CN)

(72) Inventor: **Ai Luo**, Guangdong (CN)

(**) Term: **15 Years**

(21) Appl. No.: **29/674,423**

(22) Filed: **Dec. 21, 2018**

(30) **Foreign Application Priority Data**

Jun. 22, 2018 (CN) 2018 3 0325337

(51) **LOC (12) Cl.** **02-04**

(52) **U.S. Cl.**
USPC **D2/978; D2/976**

(58) **Field of Classification Search**
USPC D2/896-900, 910-912, 946, 969, 977,
D2/978

CPC A43B 23/00; A43B 3/0078; A43C 1/02;
A43C 7/06

See application file for complete search history.

(56) **References Cited**

U.S. PATENT DOCUMENTS

D678,000 S * 3/2013 Lee A44B 19/305
D7/669
D686,909 S * 7/2013 Frydlewski A43B 3/0078
D2/978

D734,605 S * 7/2015 Van Der Pol D2/978
D736,514 S * 8/2015 Lach D2/978
D752,333 S * 3/2016 Van Der Pol D2/978
D776,990 S * 1/2017 To D7/683
D797,548 S * 9/2017 Sola D2/978
2006/0254089 A1* 11/2006 Frydlewski A43C 11/00
36/50.1
2013/0199020 A1* 8/2013 Frydlewski A43B 3/0078
29/525.01
2016/0338455 A1* 11/2016 Chuan A44B 19/305

* cited by examiner

Primary Examiner — Rashida C. Walshon

(57) **CLAIM**

The ornamental design for a shoelace, as shown and described.

DESCRIPTION

FIG. 1 is a front elevational view of a shoelace showing my new design;
FIG. 2 is a rear elevational view thereof;
FIG. 3 is a left side view thereof;
FIG. 4 is a right side view thereof;
FIG. 5 is an enlarged top plan view thereof;
FIG. 6 is an enlarged bottom plan view thereof;
FIG. 7 is a bottom, front and left side perspective view thereof; and,
FIG. 8 is a bottom, rear and right side perspective view thereof.

1 Claim, 8 Drawing Sheets

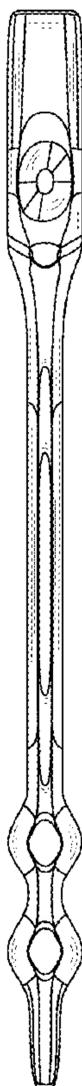

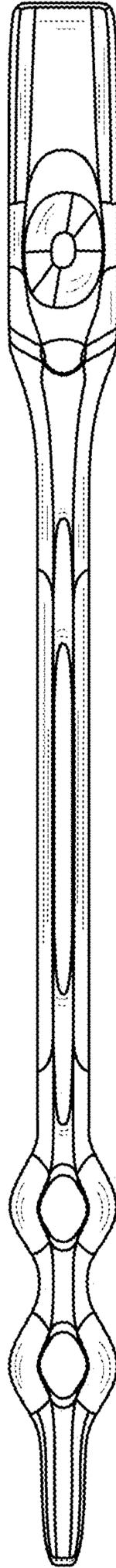

Fig. 1

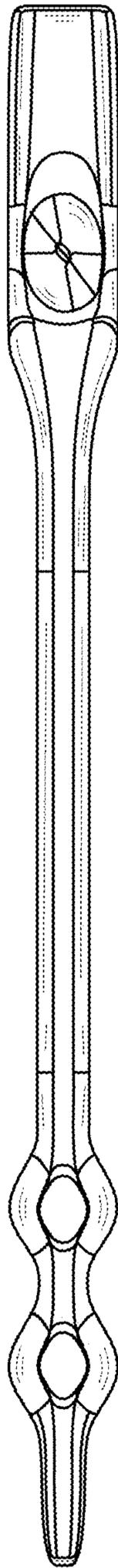

Fig. 2

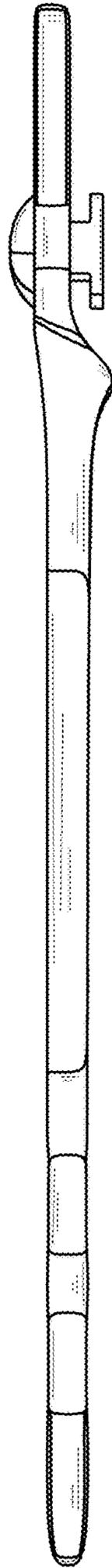

Fig. 3

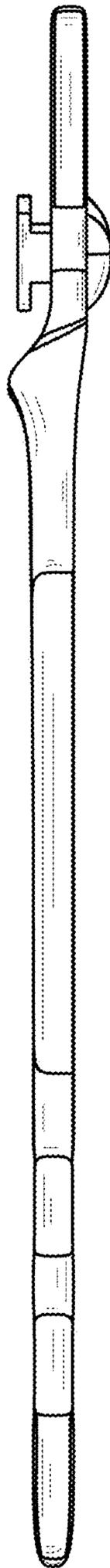

Fig. 4

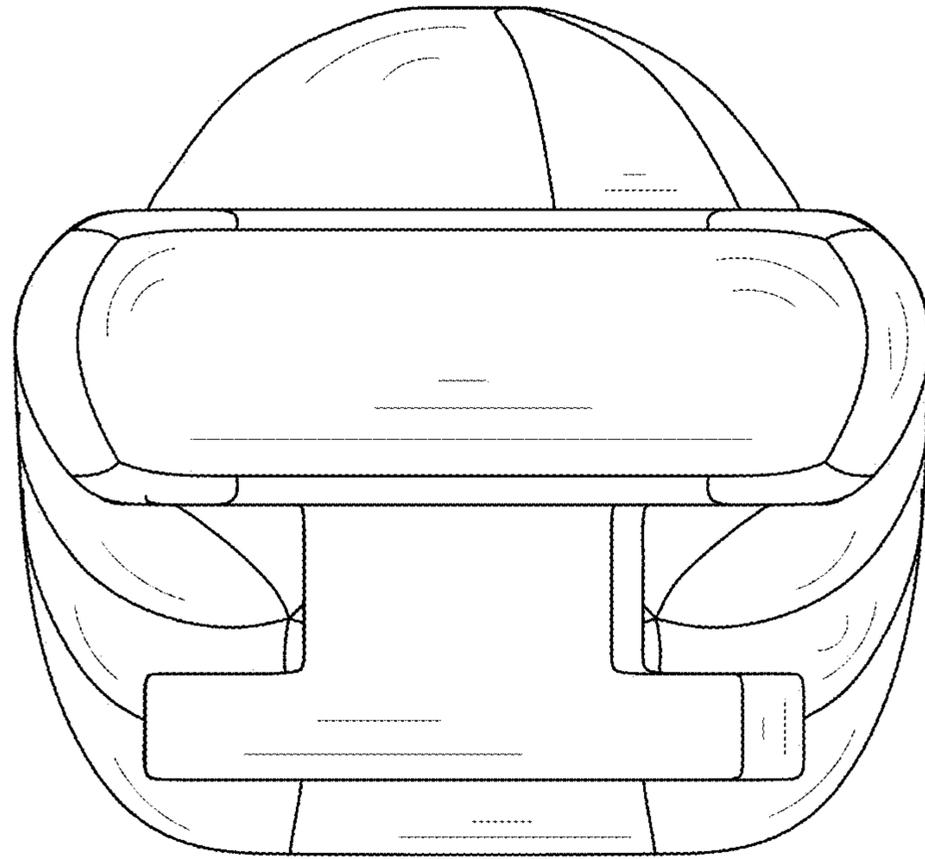

Fig. 5

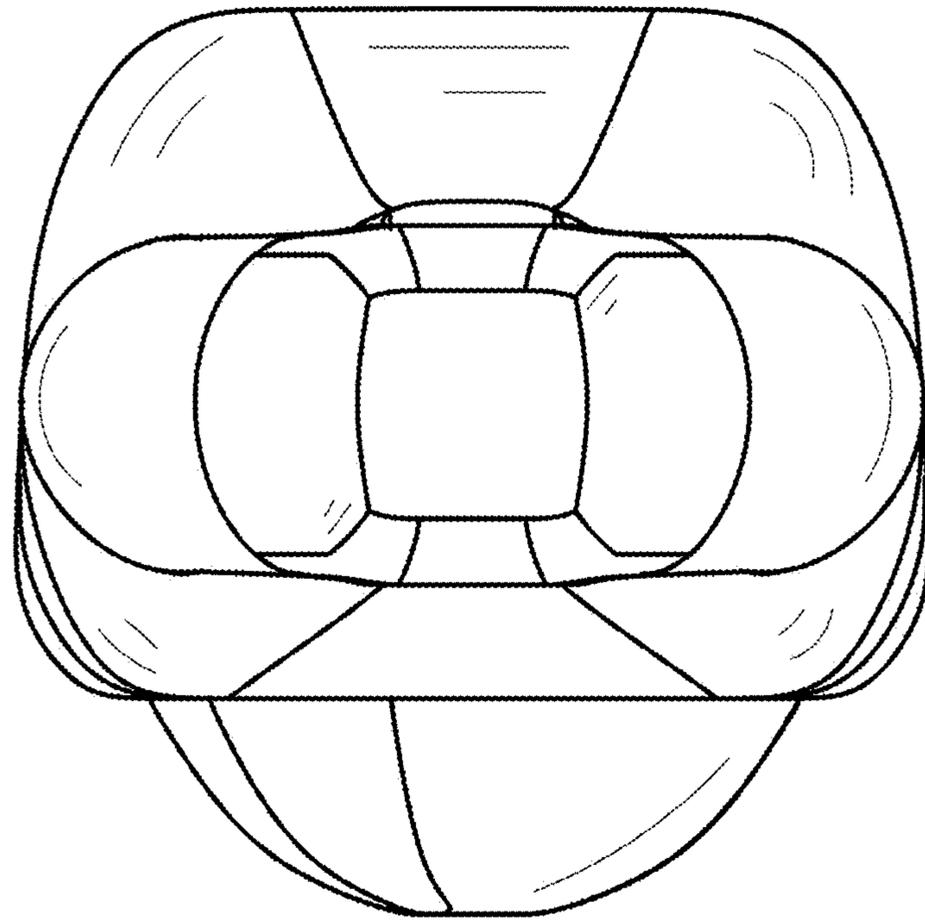

Fig. 6

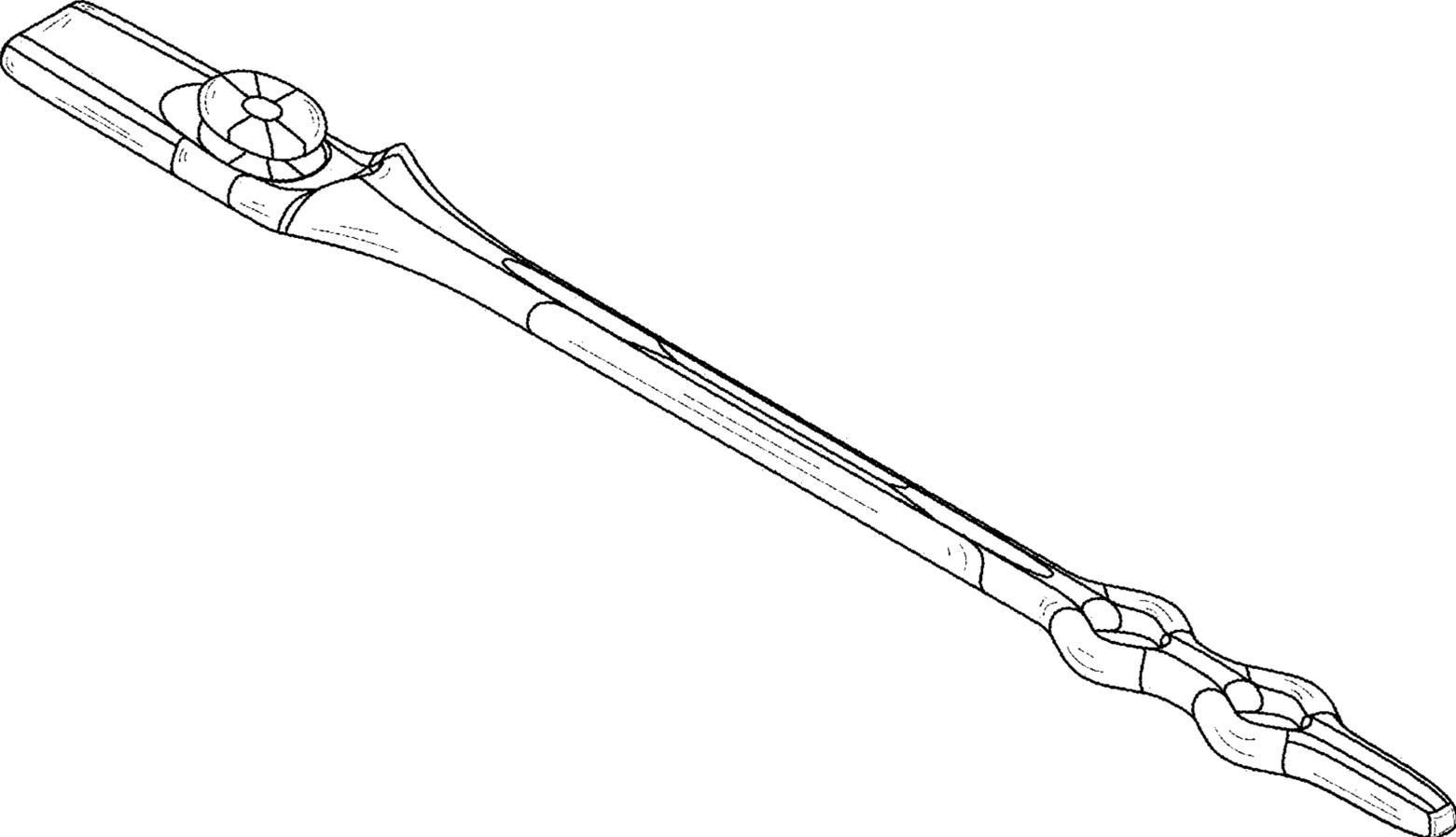

Fig. 7

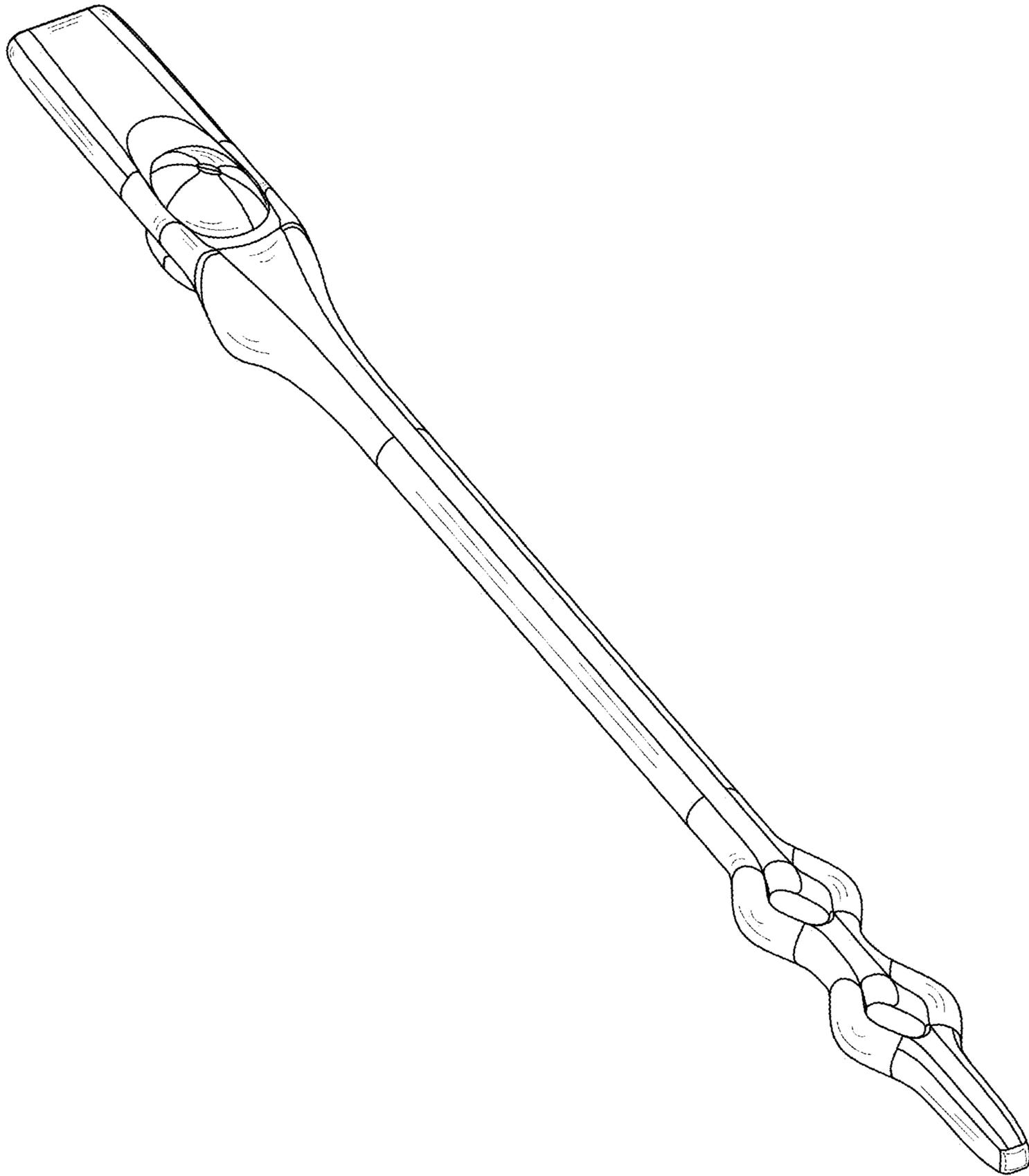

Fig. 8