



US00D869069S

(12) **United States Design Patent** (10) **Patent No.:** **US D869,069 S**
Sonneman (45) **Date of Patent:** **** Dec. 3, 2019**

- (54) **LIGHT TRIM**
- (71) Applicant: **Contemporary Visions, LLC**,
Larchmont, NY (US)
- (72) Inventor: **Robert A. Sonneman**, Mamaroneck,
NY (US)
- (73) Assignee: **Contemporary Visions, LLC**,
Larchmont, NY (US)
- (**) Term: **15 Years**
- (21) Appl. No.: **29/672,549**
- (22) Filed: **Dec. 6, 2018**
- (51) **LOC (12) Cl.** **26-99**
- (52) **U.S. Cl.**
USPC **D26/128**
- (58) **Field of Classification Search**
USPC D26/51, 63, 76, 78, 79, 80, 81, 82, 83,
D26/85, 86, 87, 88, 90, 93, 94, 105, 113,
D26/118, 119, 120, 121, 122, 128, 130,
D26/131, 137, 138, 139, 140, 141, 142
CPC F21S 2/00; F21S 6/00; F21S 4/00; F21S
4/003; F21S 4/005; F21S 4/006; F21S
4/007; F21S 4/008; F21S 8/00; F21S
8/024; F21S 8/026; F21S 8/031; F21S
8/033; F21S 8/035-037; F21S 8/04; F21S
8/043; F21S 8/063
See application file for complete search history.

- D553,791 S * 10/2007 Bouroullec D26/128
- D819,259 S * 5/2018 McTaggart D26/128
- D835,836 S * 12/2018 Furman D26/128
- D836,239 S * 12/2018 Sonneman D26/118

* cited by examiner

Primary Examiner — Brian N. Vinson
(74) *Attorney, Agent, or Firm* — Gottlieb, Rackman & Reisman, P.C.

(57) **CLAIM**

The ornamental design for a light trim, as shown and described.

DESCRIPTION

FIG. 1 is a perspective view of a first embodiment of a light trim showing my new design;
 FIG. 2 is a first side elevational view of FIG. 1;
 FIG. 3 is a second side elevational view of FIG. 1;
 FIG. 4 is a third side elevational view of FIG. 1;
 FIG. 5 is a fourth side elevational view of FIG. 1;
 FIG. 6 is a top plan view of FIG. 1;
 FIG. 7 is a bottom plan view of FIG. 1;
 FIG. 8 is a perspective view of another embodiment of a light trim showing my new design;
 FIG. 9 is a first side elevational view of FIG. 8;
 FIG. 10 is a second side elevational view of FIG. 8;
 FIG. 11 is a third side elevational view of FIG. 8;
 FIG. 12 is a fourth side elevational view of FIG. 8;
 FIG. 13 is a top plan view of FIG. 8; and,
 FIG. 14 is a bottom plan view of FIG. 8.

The broken lines shown in the drawings are included for the purpose of illustrating elements of the light trim that is attachable to a light fixture and form no part of the claimed design.

(56) **References Cited**

U.S. PATENT DOCUMENTS

- D363,362 S * 10/1995 Davis, Sr. D26/131
- D481,157 S * 10/2003 Fickas D26/128

1 Claim, 14 Drawing Sheets

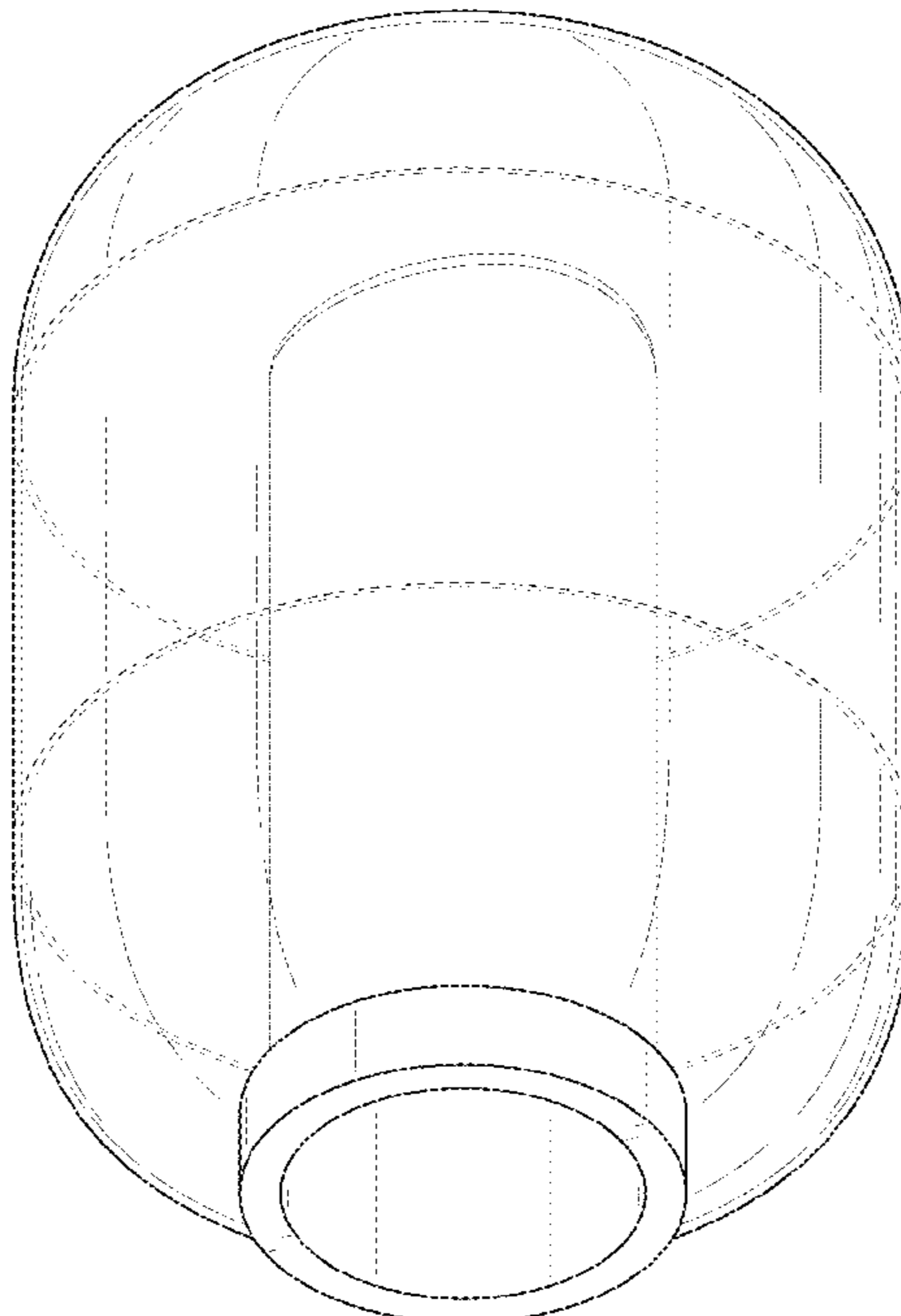

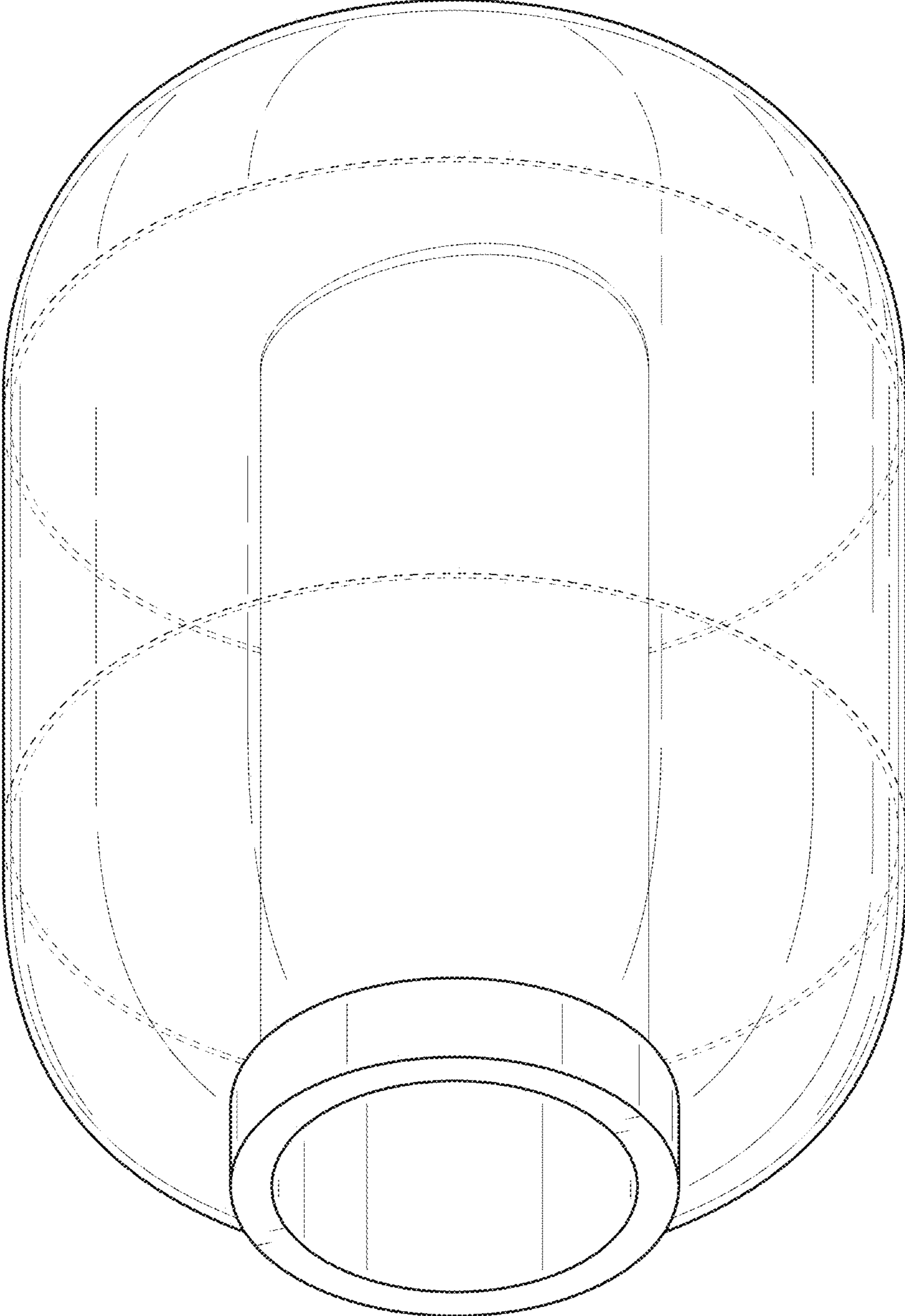

FIG. 1

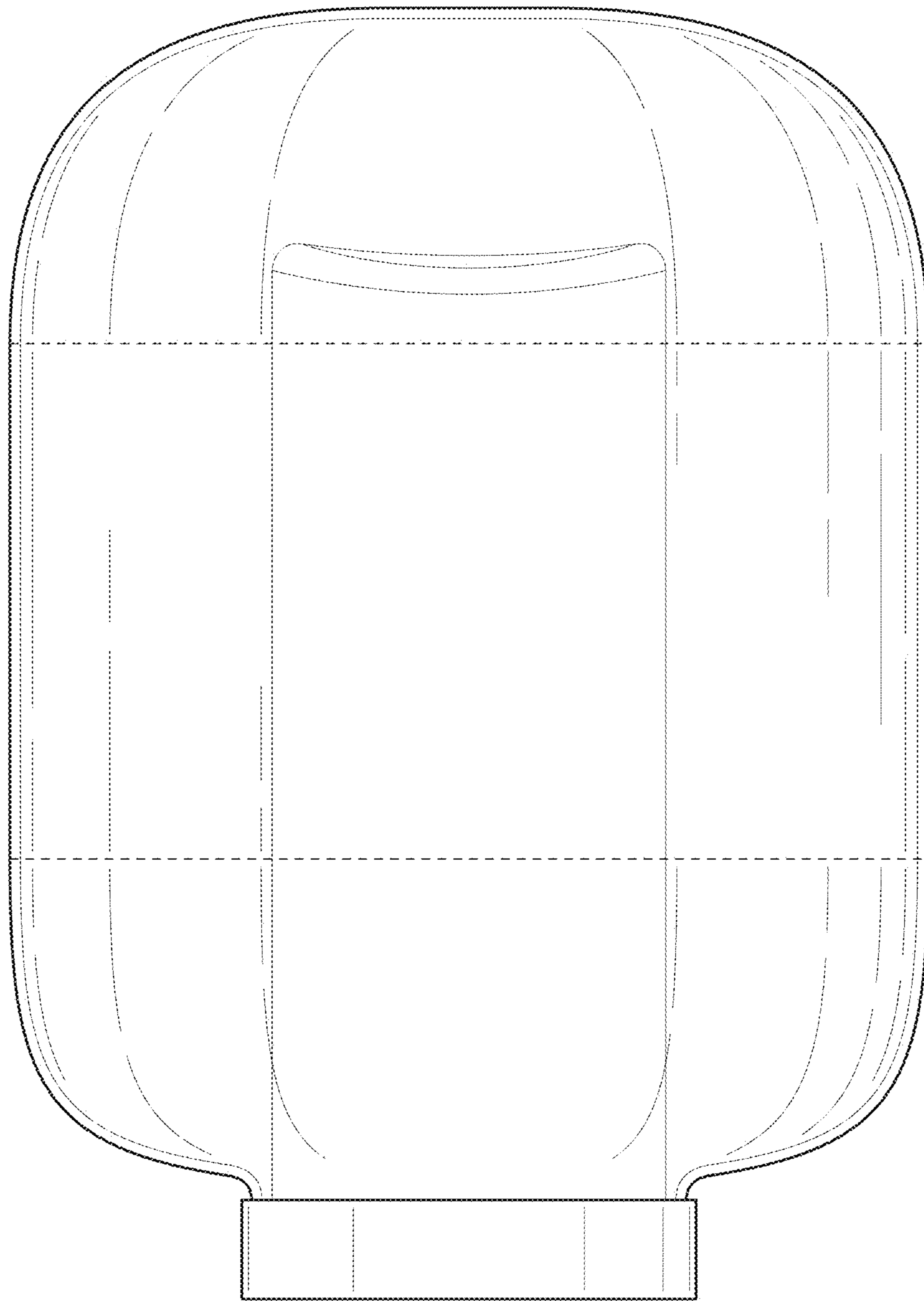

FIG. 2

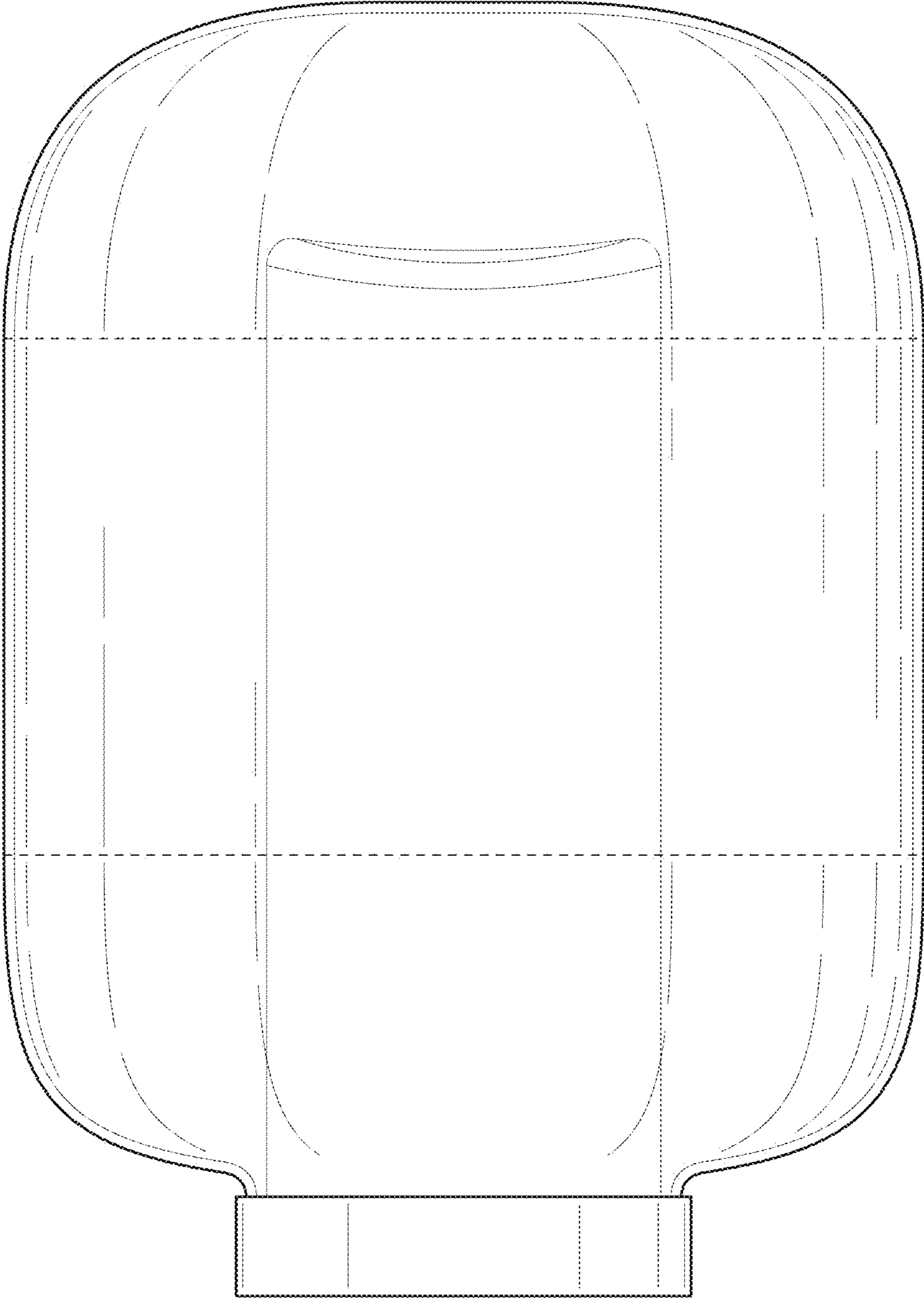

FIG. 3

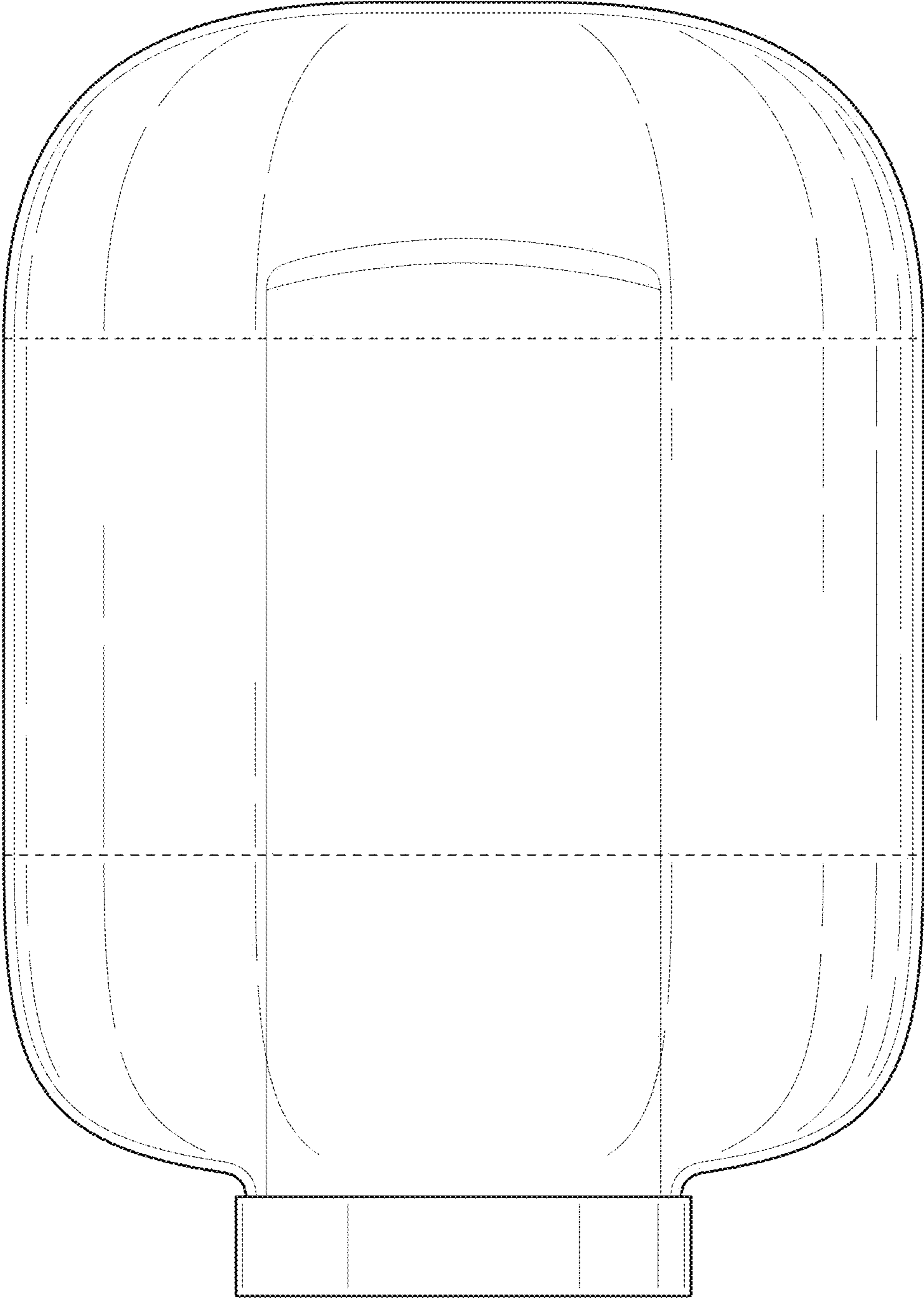

FIG. 4

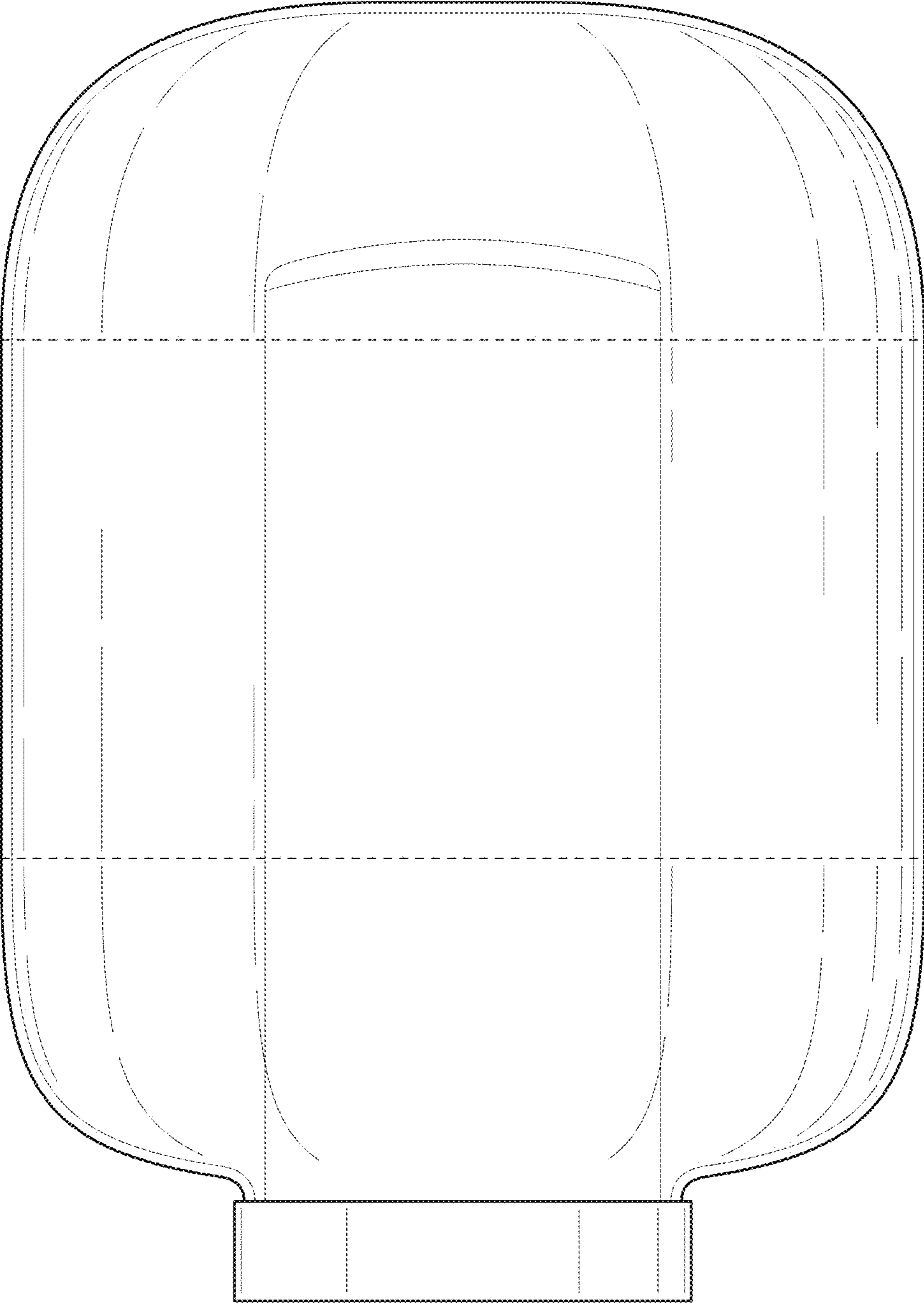

FIG. 5

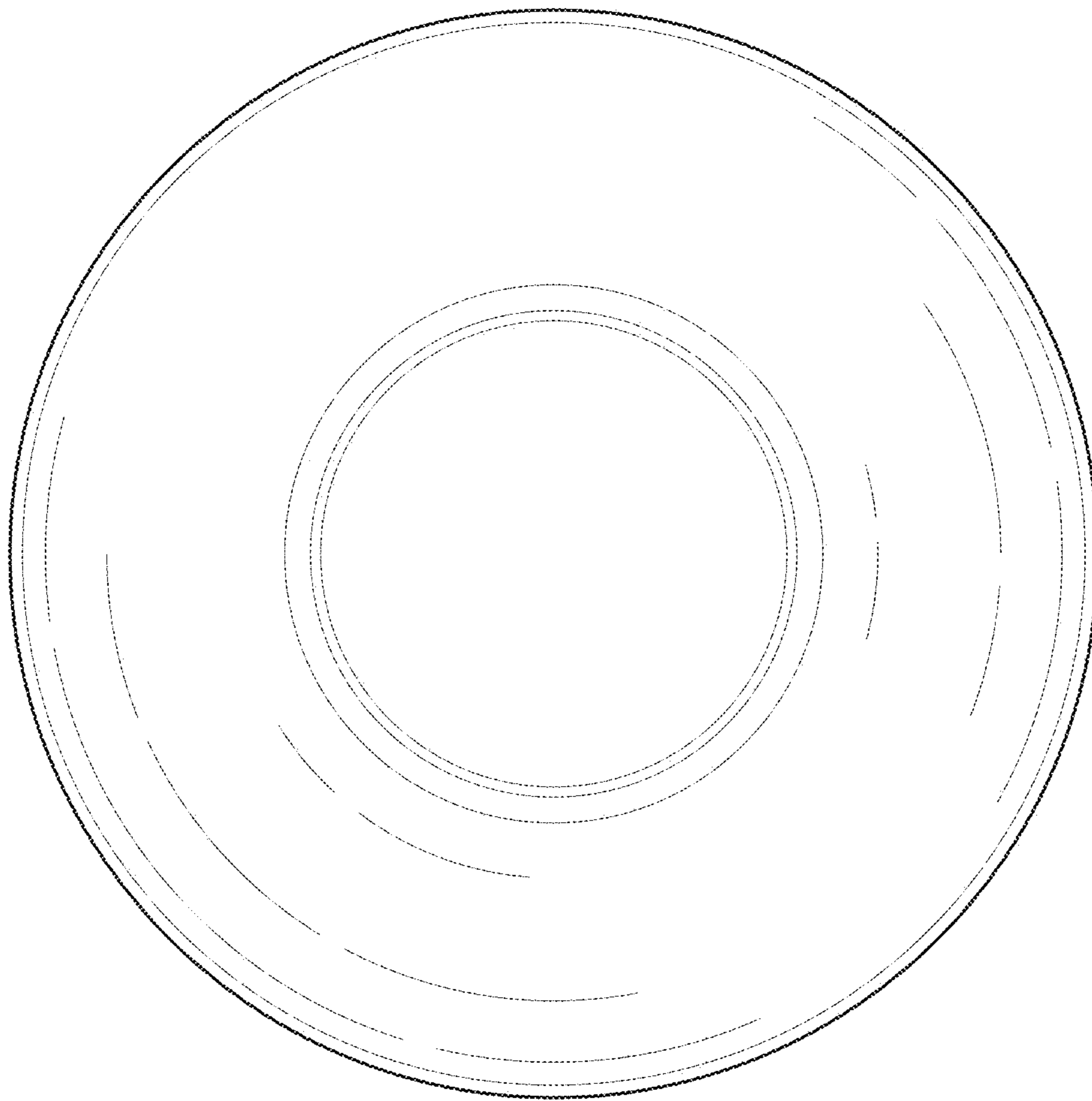

FIG. 6

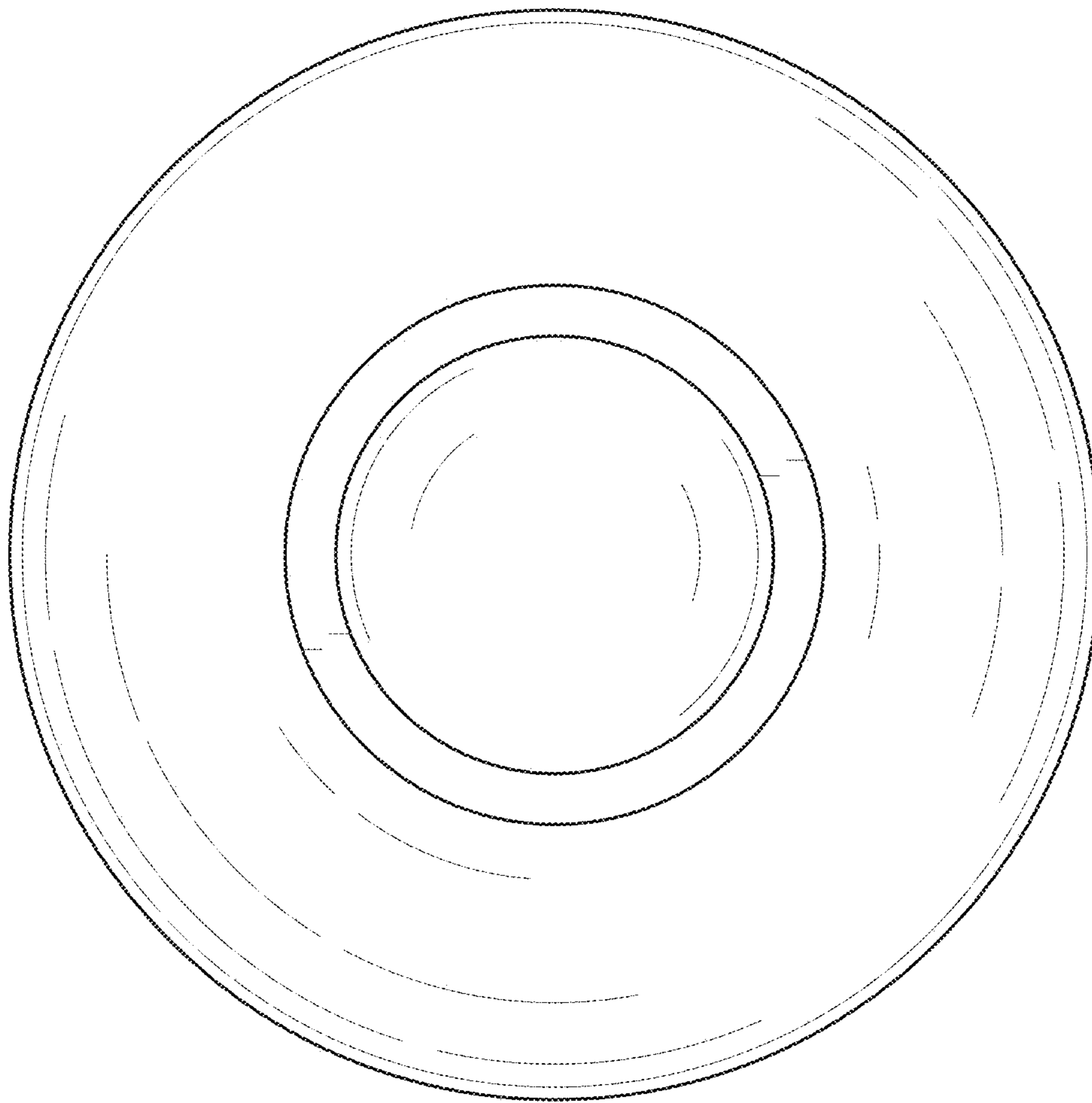

FIG. 7

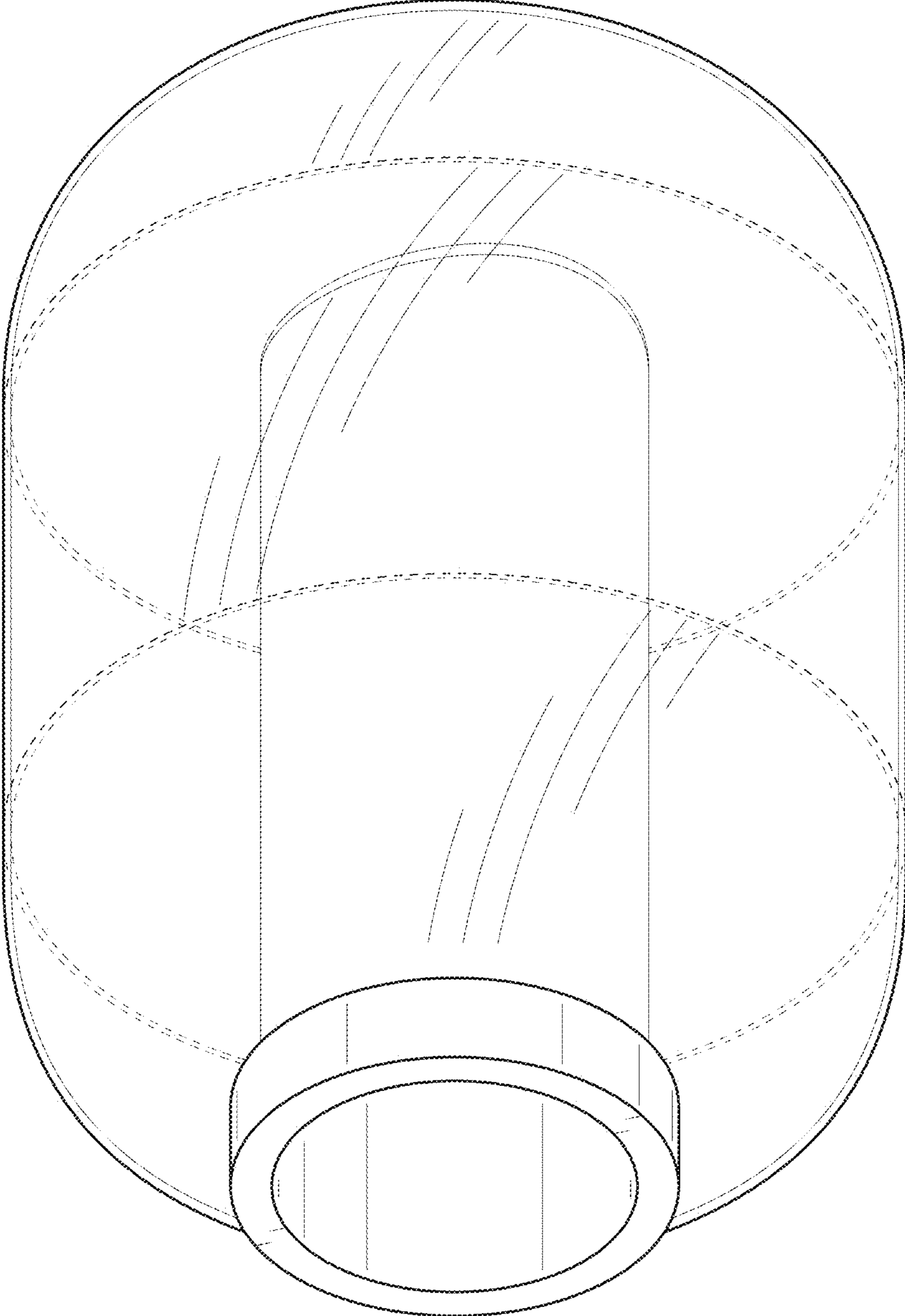

FIG. 8

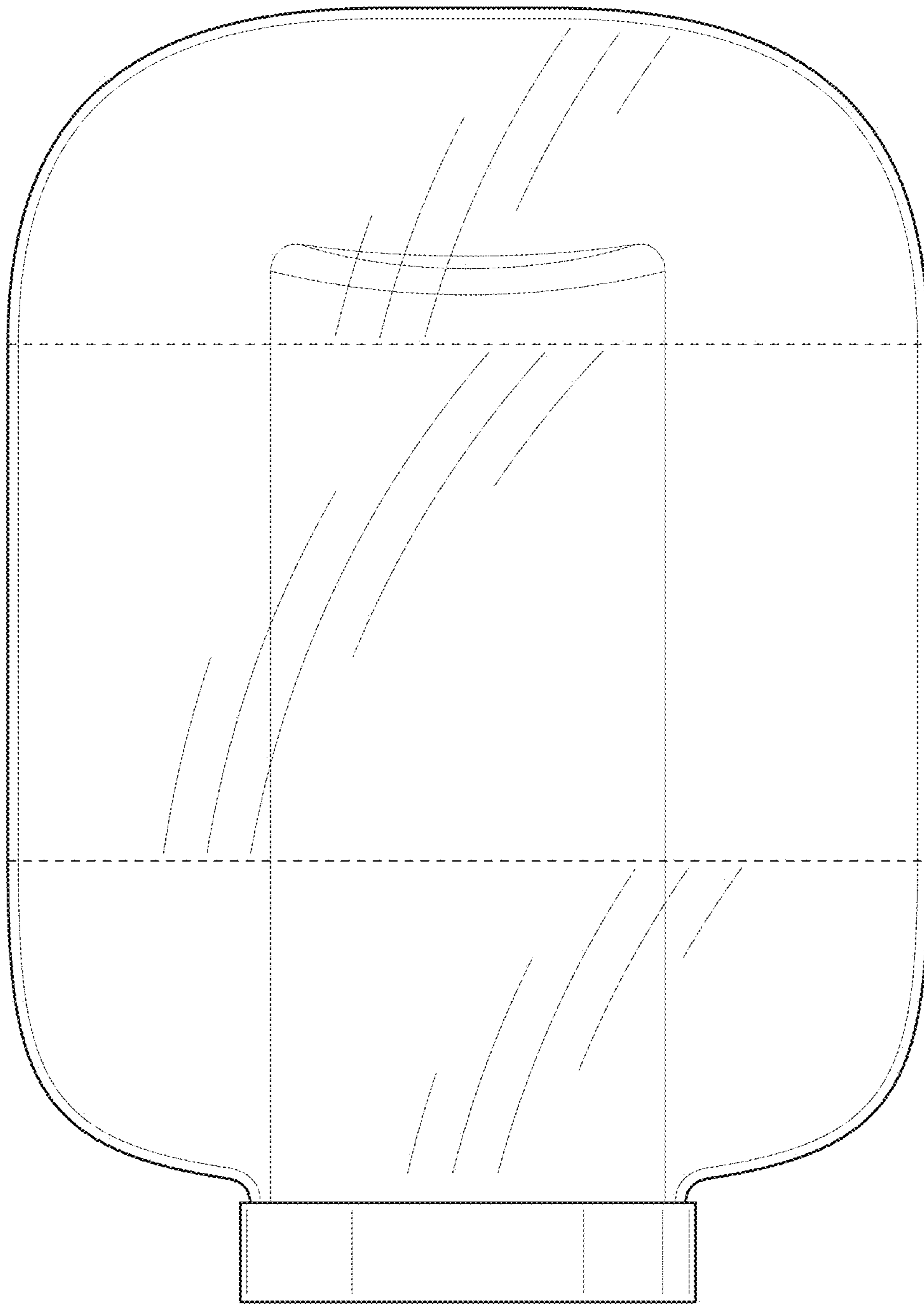

FIG. 9

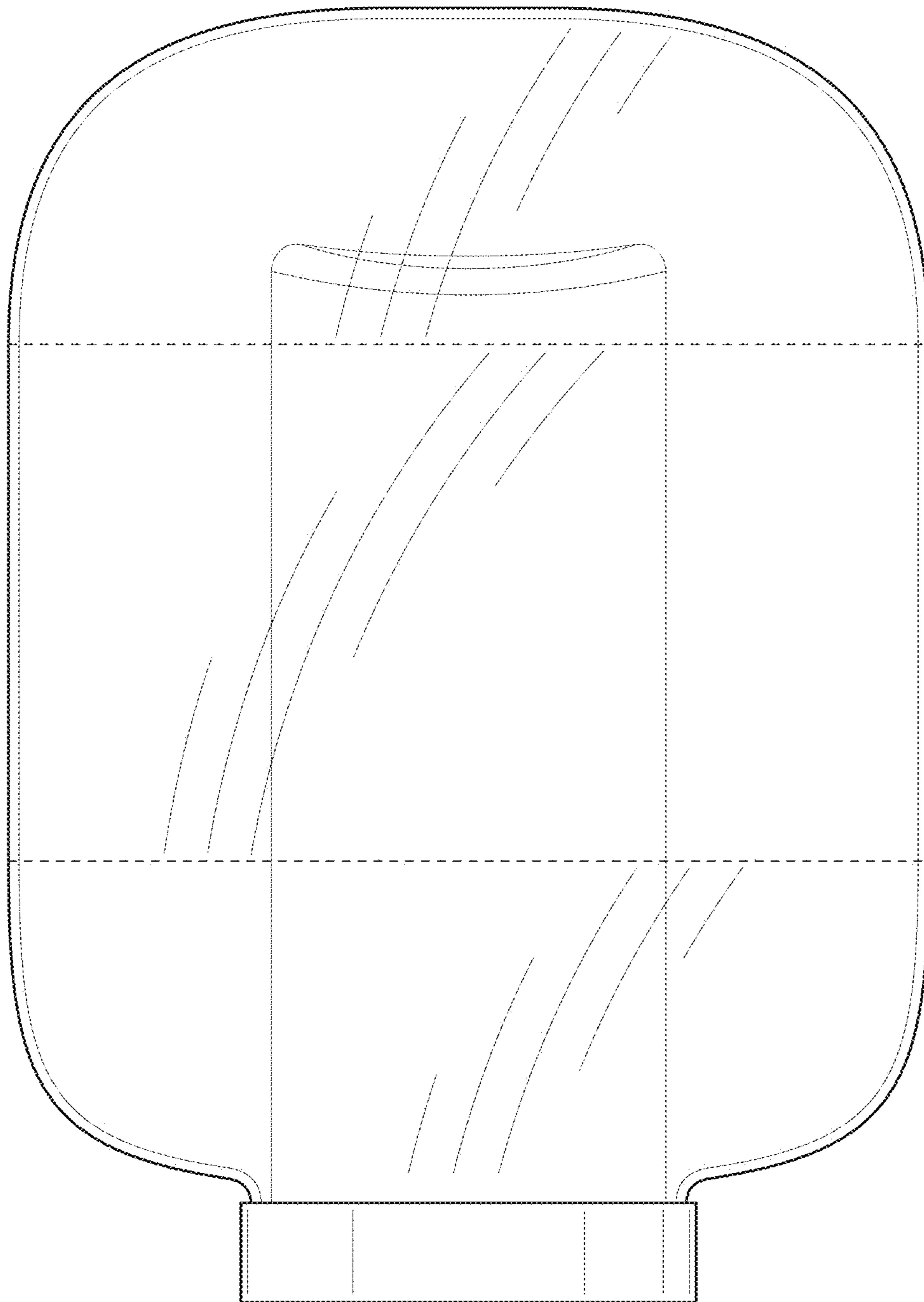

FIG. 10

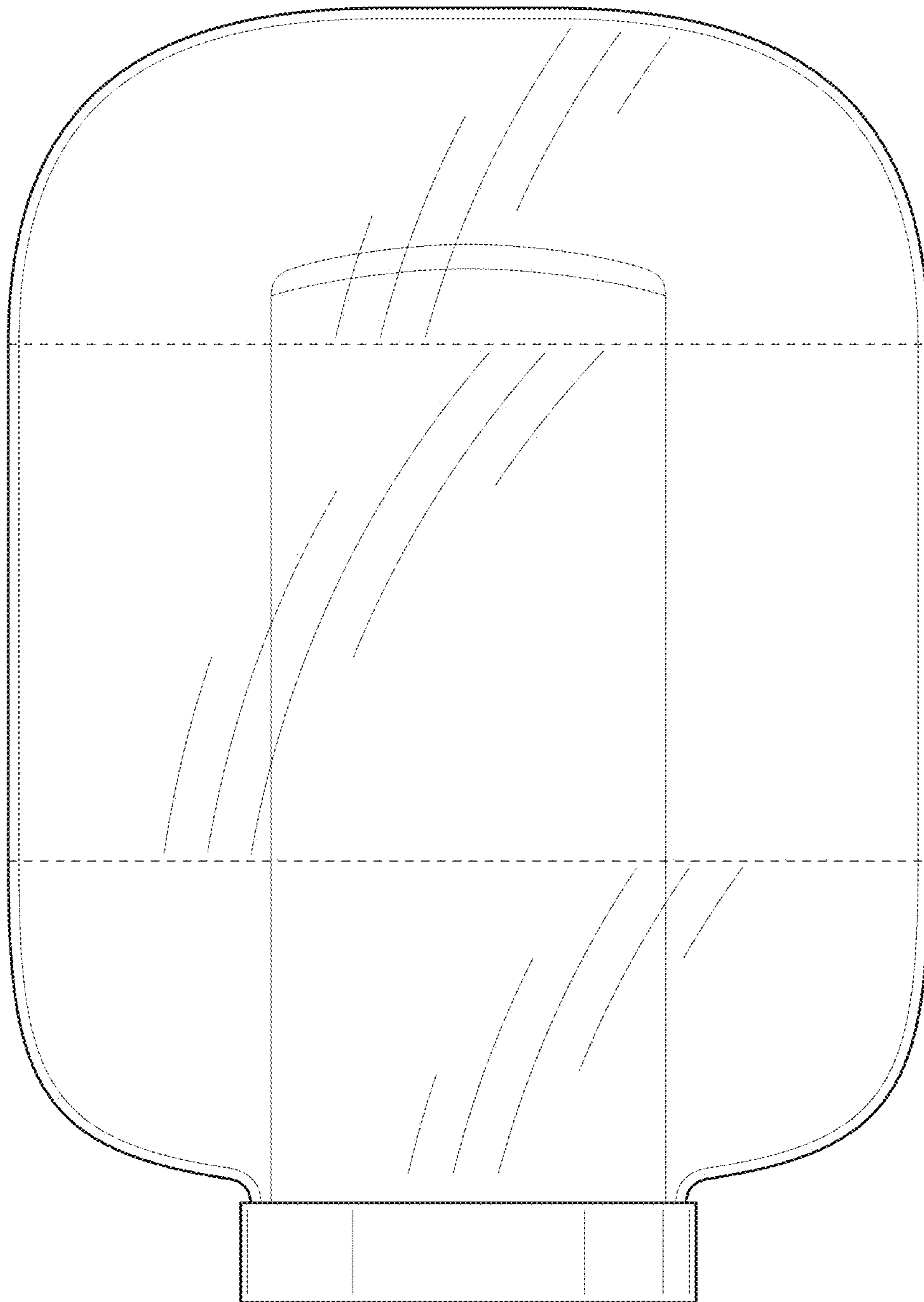

FIG. 11

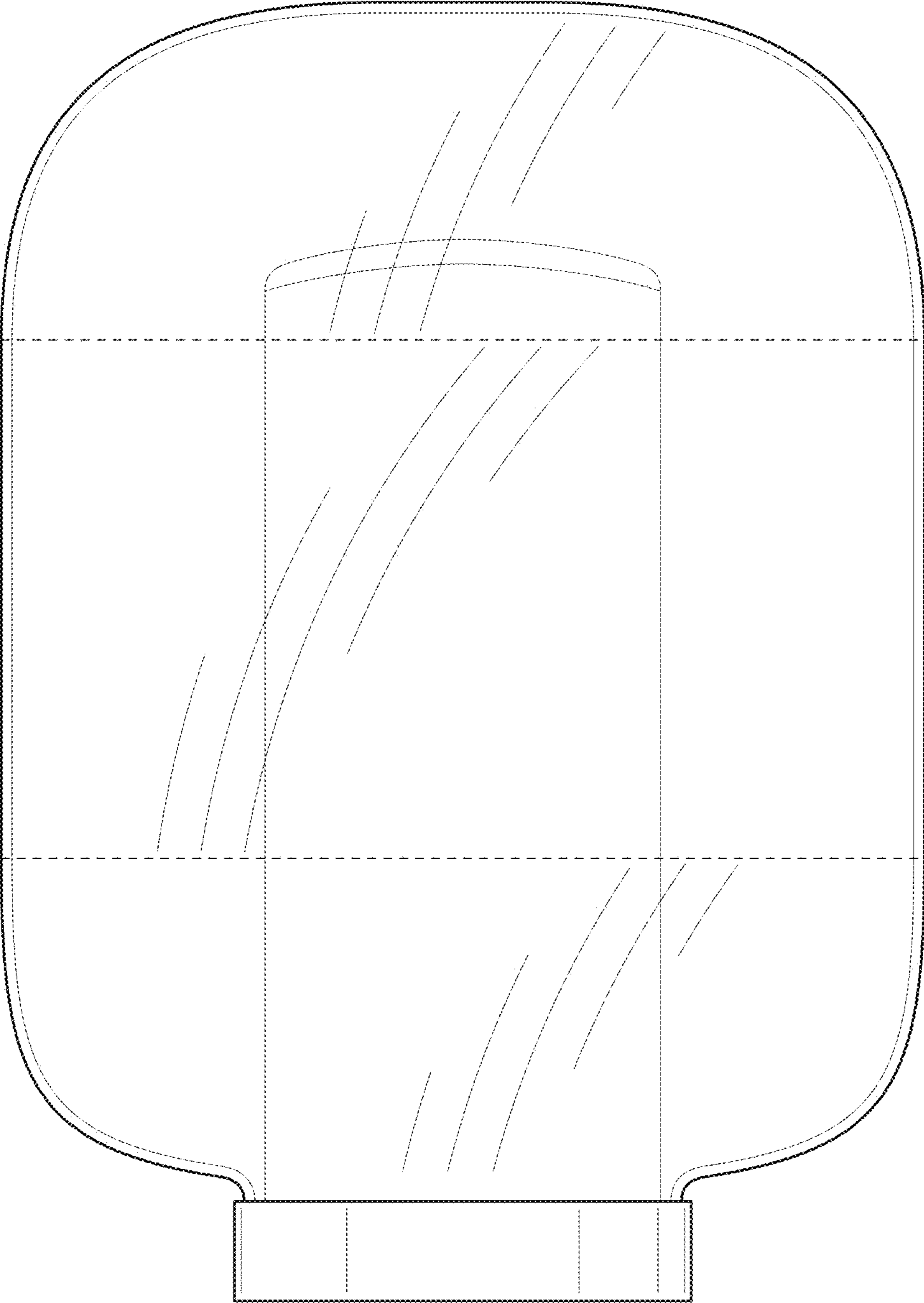

FIG. 12

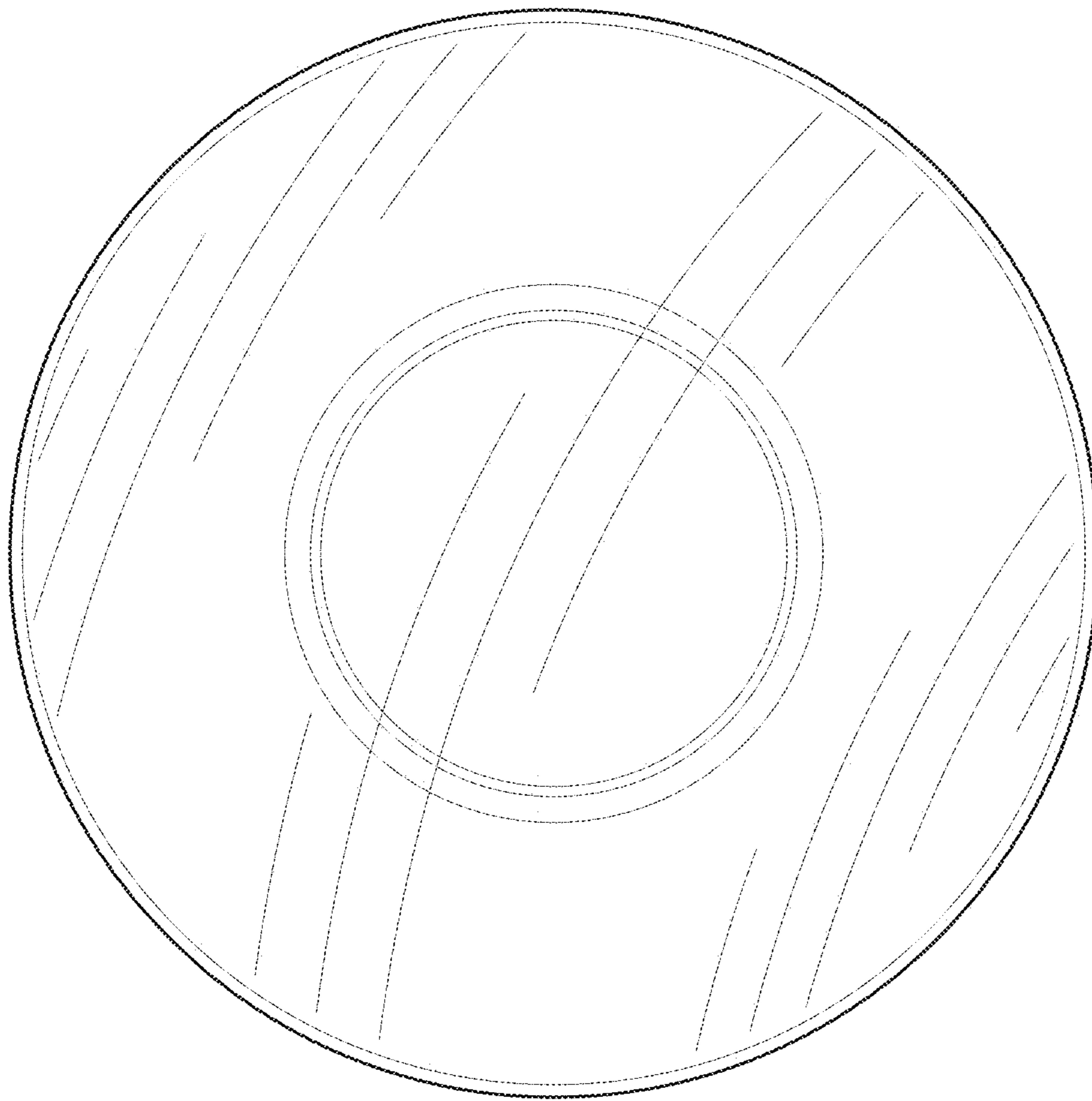

FIG. 13

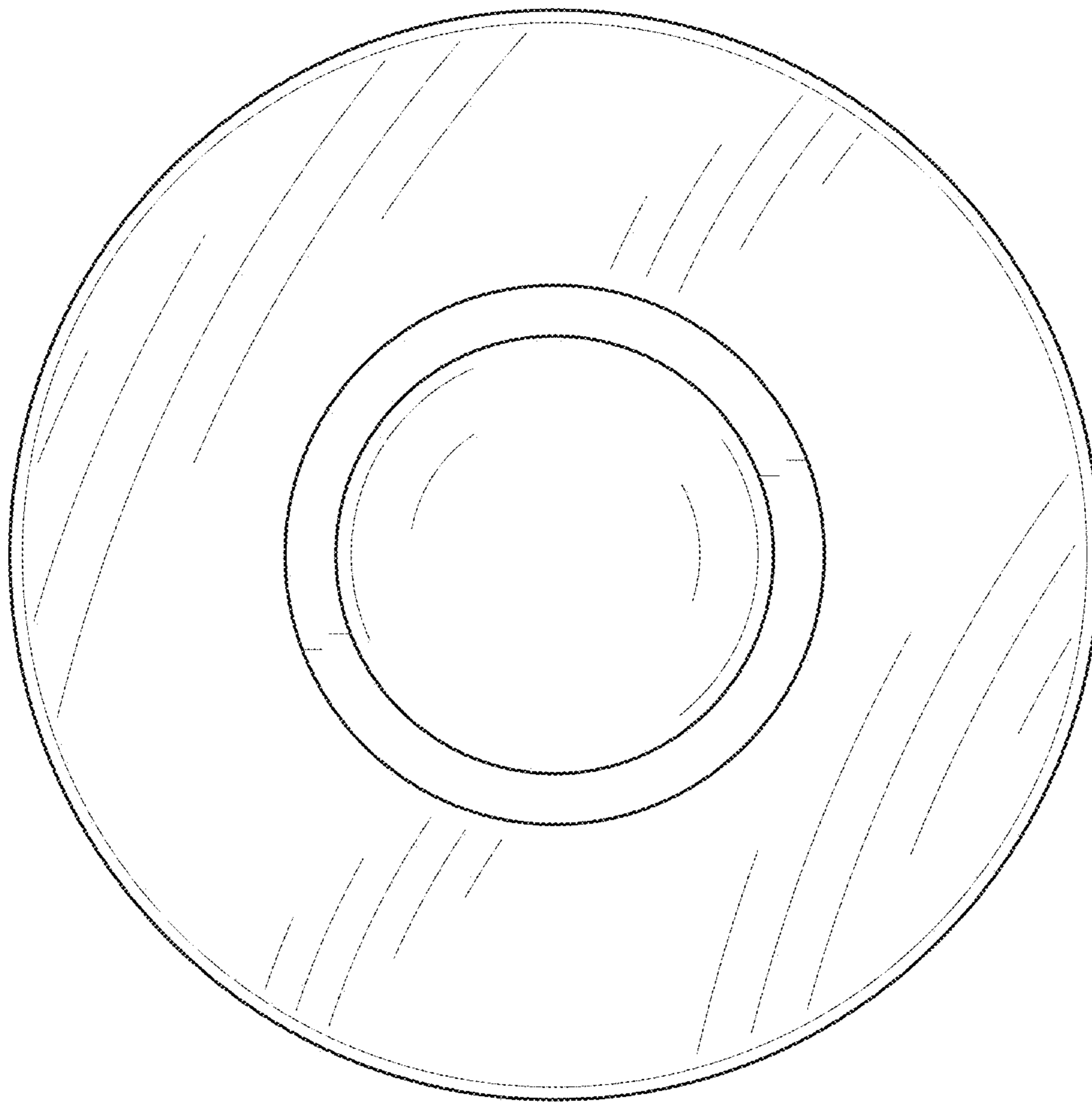

FIG. 14