

US00D869024S

(12) **United States Design Patent** (10) **Patent No.:** **US D869,024 S**
Nishihama (45) **Date of Patent:** **** Dec. 3, 2019**

(54) **FRONT COMBINATION LAMP FOR AN AUTOMOBILE**

(71) Applicant: **Toyokazu Nishihama**, Nagakute (JP)

(72) Inventor: **Toyokazu Nishihama**, Nagakute (JP)

(73) Assignee: **TOYOTA JIDOSHA KABUSHIKI KAISHA** (JP)

(**) Term: **15 Years**

(21) Appl. No.: **29/656,534**

(22) Filed: **Jul. 13, 2018**

(30) **Foreign Application Priority Data**

Jan. 17, 2018 (JP) 2018-000649
Jan. 17, 2018 (JP) 2018-000650
Jan. 17, 2018 (JP) 2018-000659

(51) **LOC (12) Cl.** **26-06**

(52) **U.S. Cl.**
USPC **D26/28**

(58) **Field of Classification Search**

USPC D26/28-36, 139
CPC F21S 48/00; F21S 48/10; F21S 48/115;
F21S 48/225; F21S 48/1233; F21S
48/1266; F21S 48/1388; F21S 48/2268;
F21V 21/04; F21K 9/00; F21K 29/004;
B60Q 9/13; B60Q 9/135; B60Q 9/1375

See application file for complete search history.

(56) **References Cited**

U.S. PATENT DOCUMENTS

D660,481 S * 5/2012 Gotschke D26/28
D671,248 S * 11/2012 Fuchigami D26/28

(Continued)

OTHER PUBLICATIONS

Toyota Motor Corporation, Toyota Vitz (2014), catalog of Vitz, Apr. 2014.

(Continued)

Primary Examiner — Marcus A Jackson

(74) *Attorney, Agent, or Firm* — Saidman DesignLaw Group, LLC

(57) **CLAIM**

The ornamental design for a front combination lamp for an automobile, as shown and described.

DESCRIPTION

FIG. 1 is a perspective view of a front combination lamp for an automobile showing my new design;

FIG. 2 is a front view thereof;

FIG. 3 is a rear view thereof;

FIG. 4 is a left side view thereof;

FIG. 5 is a right side view thereof;

FIG. 6 is a top view thereof;

FIG. 7 is a bottom view thereof;

FIG. 8 is a perspective view of second embodiment thereof;

FIG. 9 is a front view thereof;

FIG. 10 is a rear view thereof;

FIG. 11 is a left side view thereof;

FIG. 12 is a right side view thereof;

FIG. 13 is a top view thereof;

FIG. 14 is a bottom view thereof;

FIG. 15 is a perspective view of a third embodiment thereof;

FIG. 16 is a front view thereof;

FIG. 17 is a rear view thereof;

FIG. 18 is a left side view thereof;

FIG. 19 is a right side view thereof;

FIG. 20 is a top view thereof; and,

FIG. 21 is a bottom view thereof.

The claimed design is indicated by the relatively dark portions in the figures. The relatively light portions form no part of the claimed design.

1 Claim, 21 Drawing Sheets

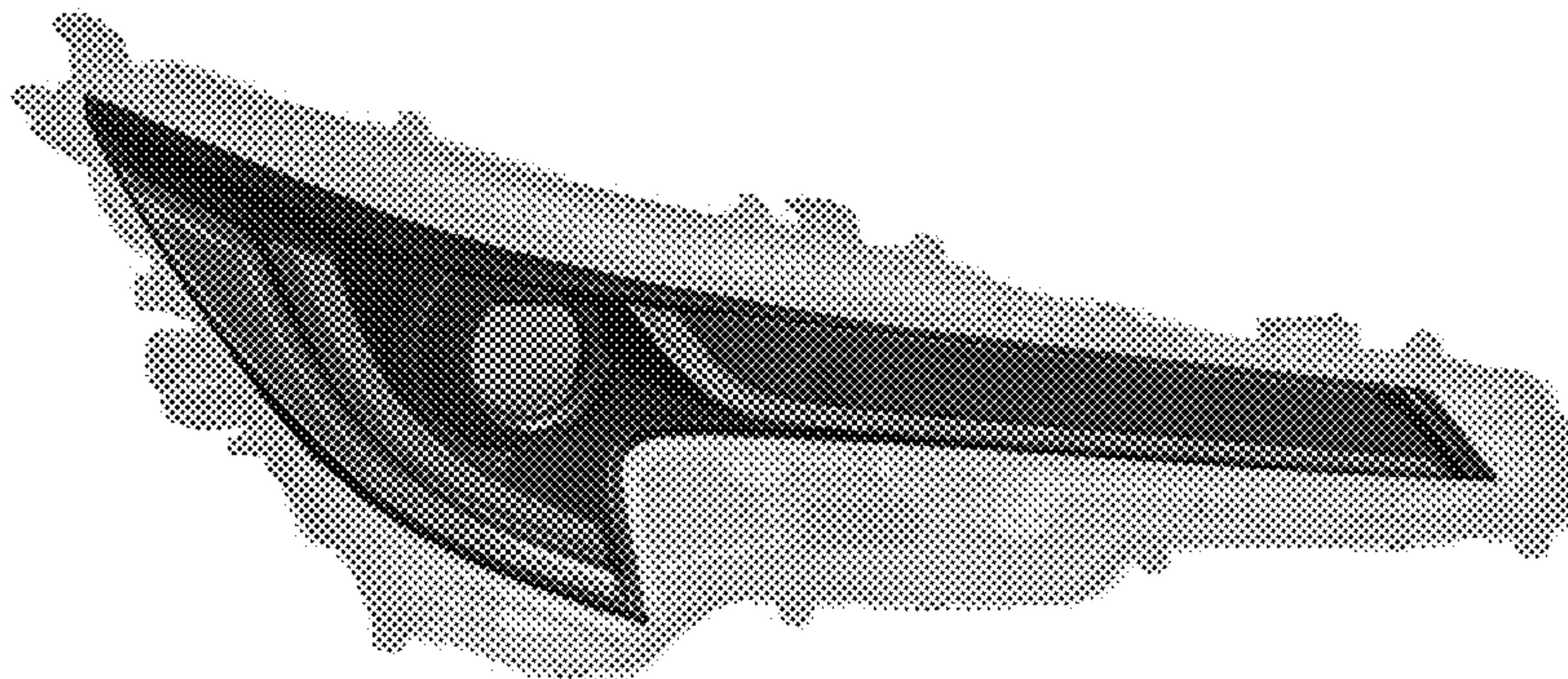

(56)

References Cited

U.S. PATENT DOCUMENTS

D679,429 S * 4/2013 Frenzel D26/28
D708,768 S * 7/2014 Futschik D26/28
D709,213 S * 7/2014 Futschik D26/28

OTHER PUBLICATIONS

NetCarShow, Jaguar XE (2016), <https://www.netcarshow.com/jaguar/2016-xe/1280x960/wallpaper_e4.htm>, available as early as Jul. 11, 2017.

NetCarShow, Volkswagen Golf-R (2017), <https://www.netcarshow.com/volkswagen/2017-golf_r/1280x960/wallpaper_04.htm>, available as early as Jul. 11, 2017.

* cited by examiner

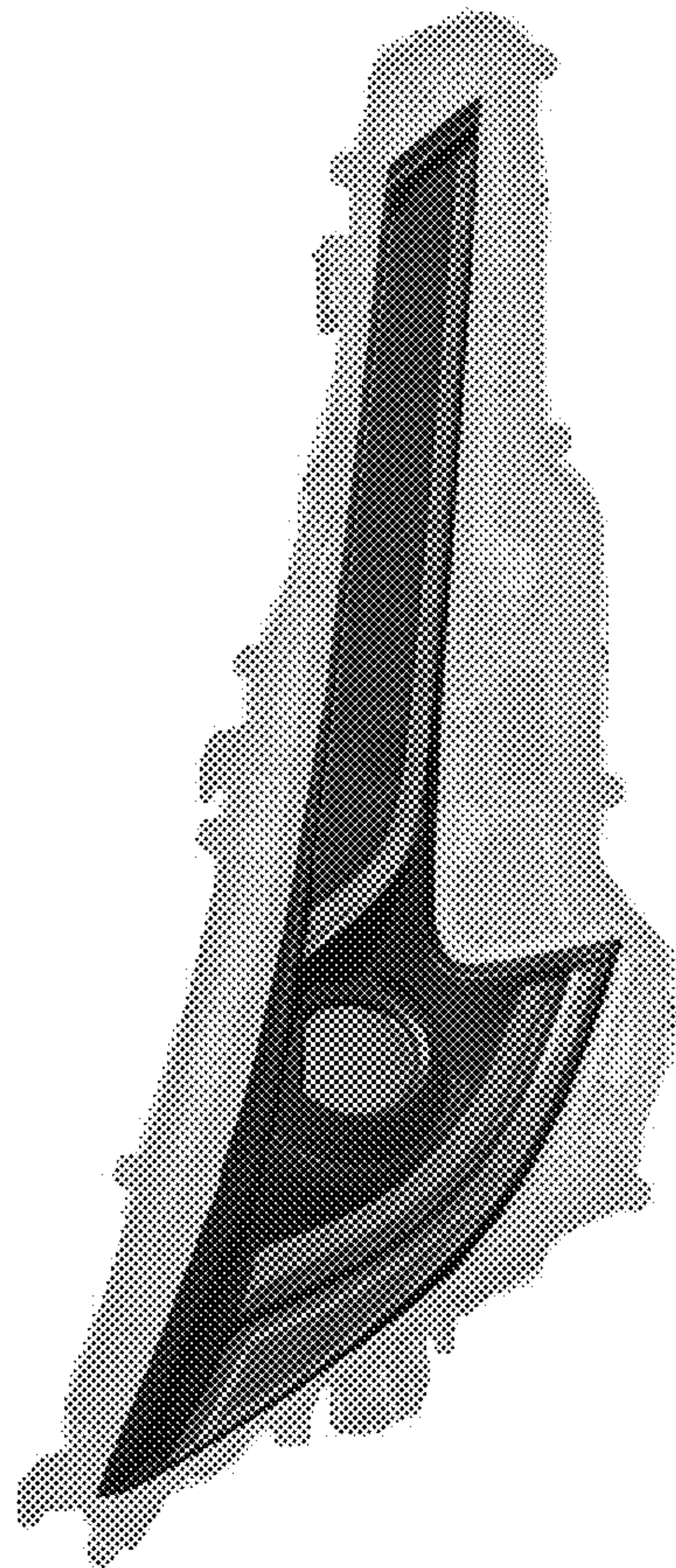

FIG. 1

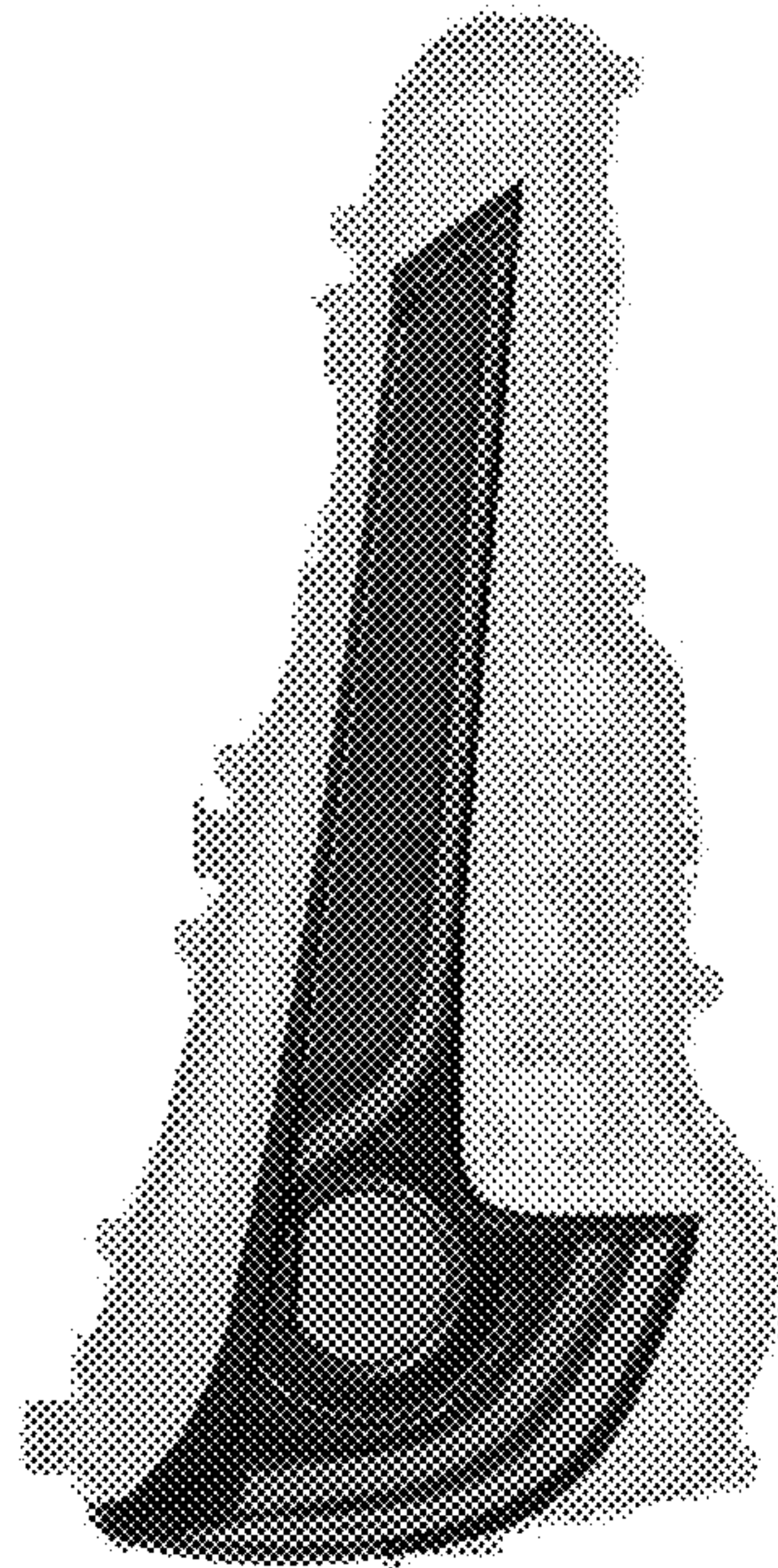

FIG. 2

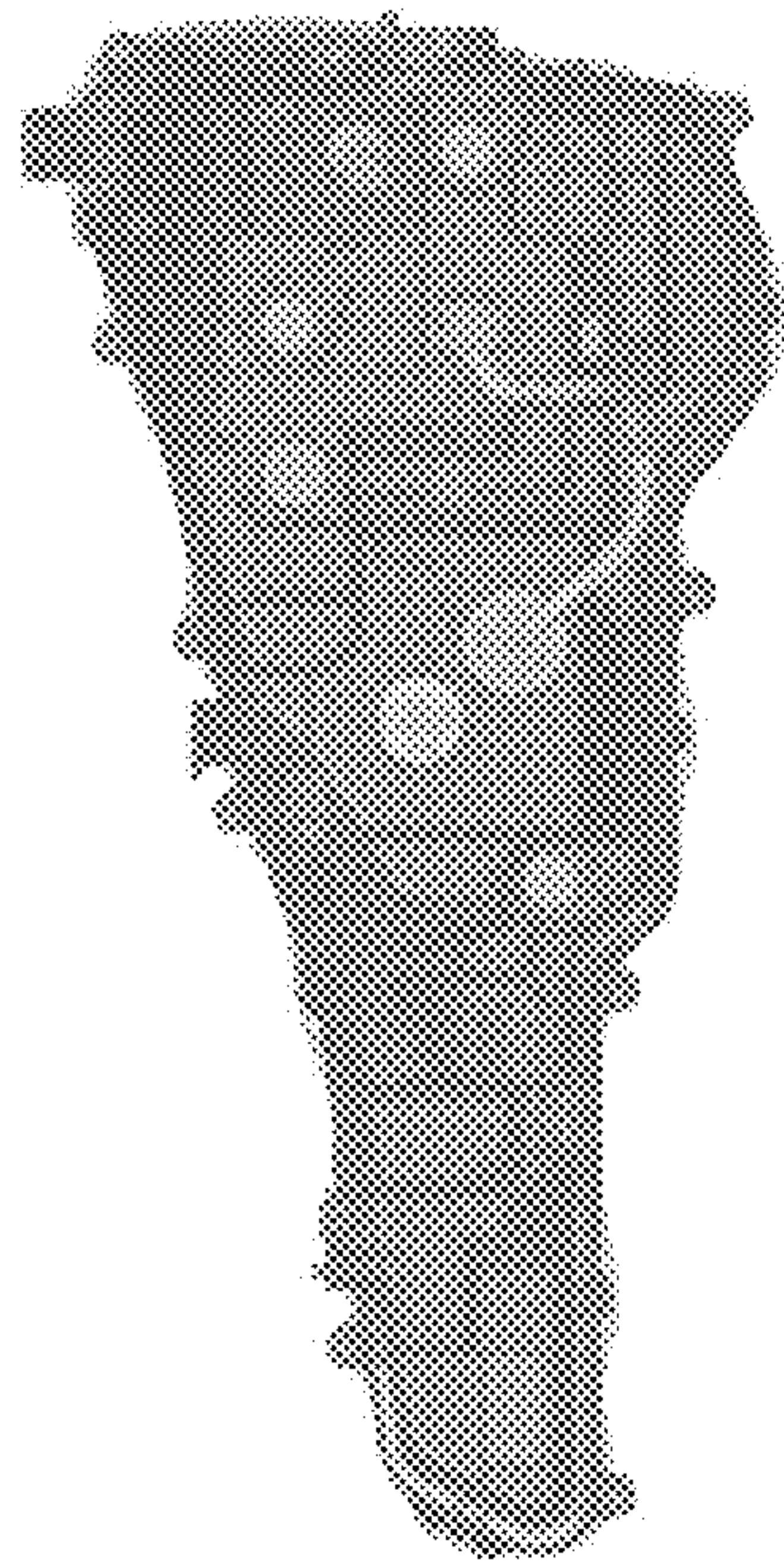

FIG. 3

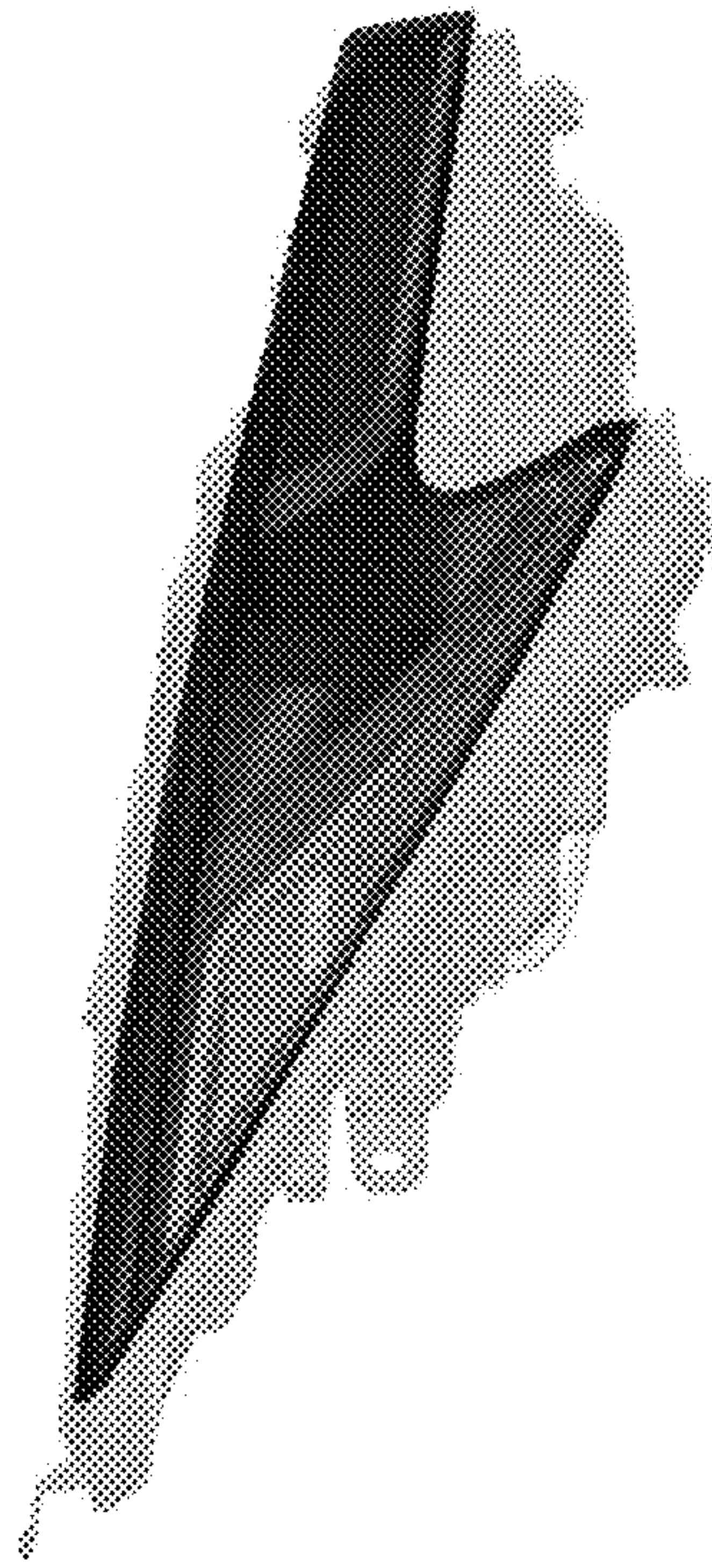

FIG. 4

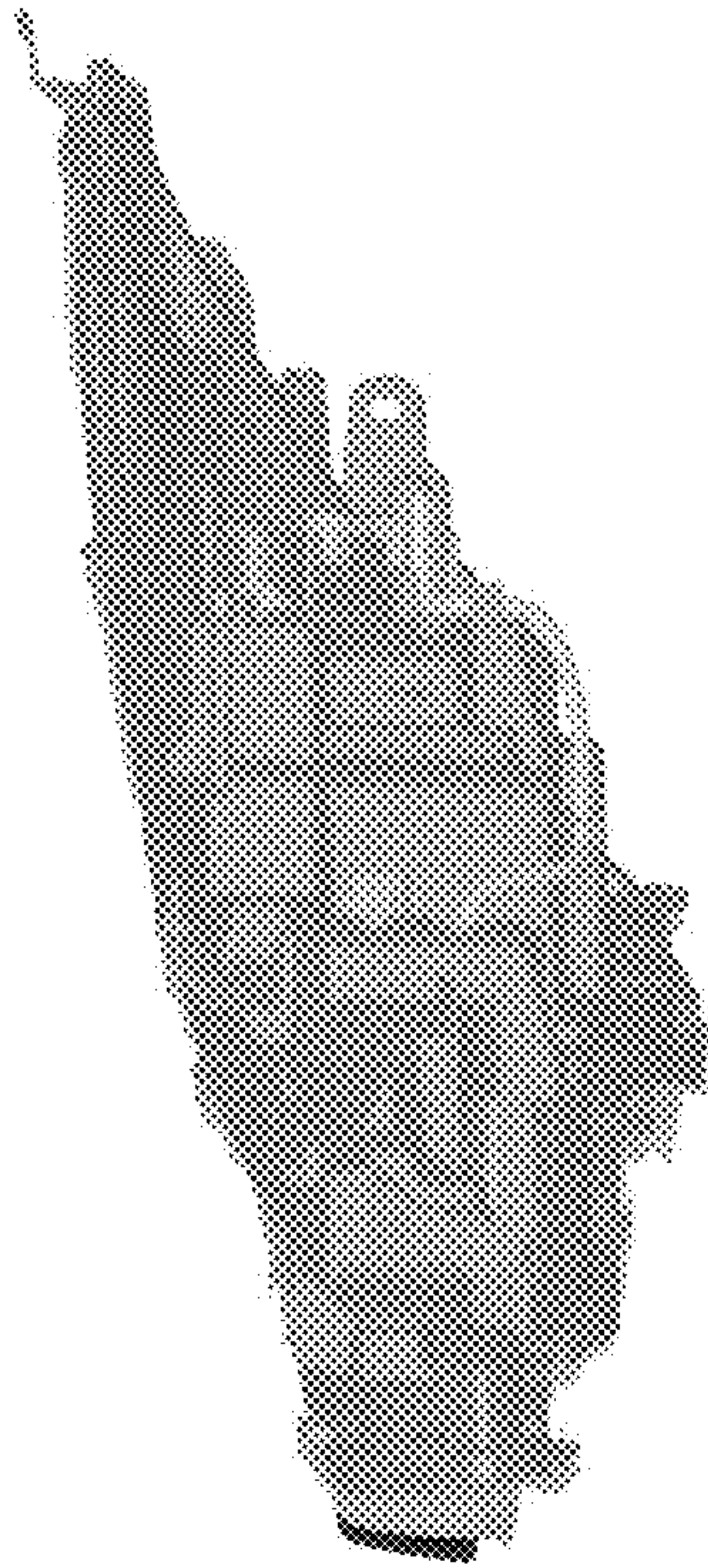

FIG. 5

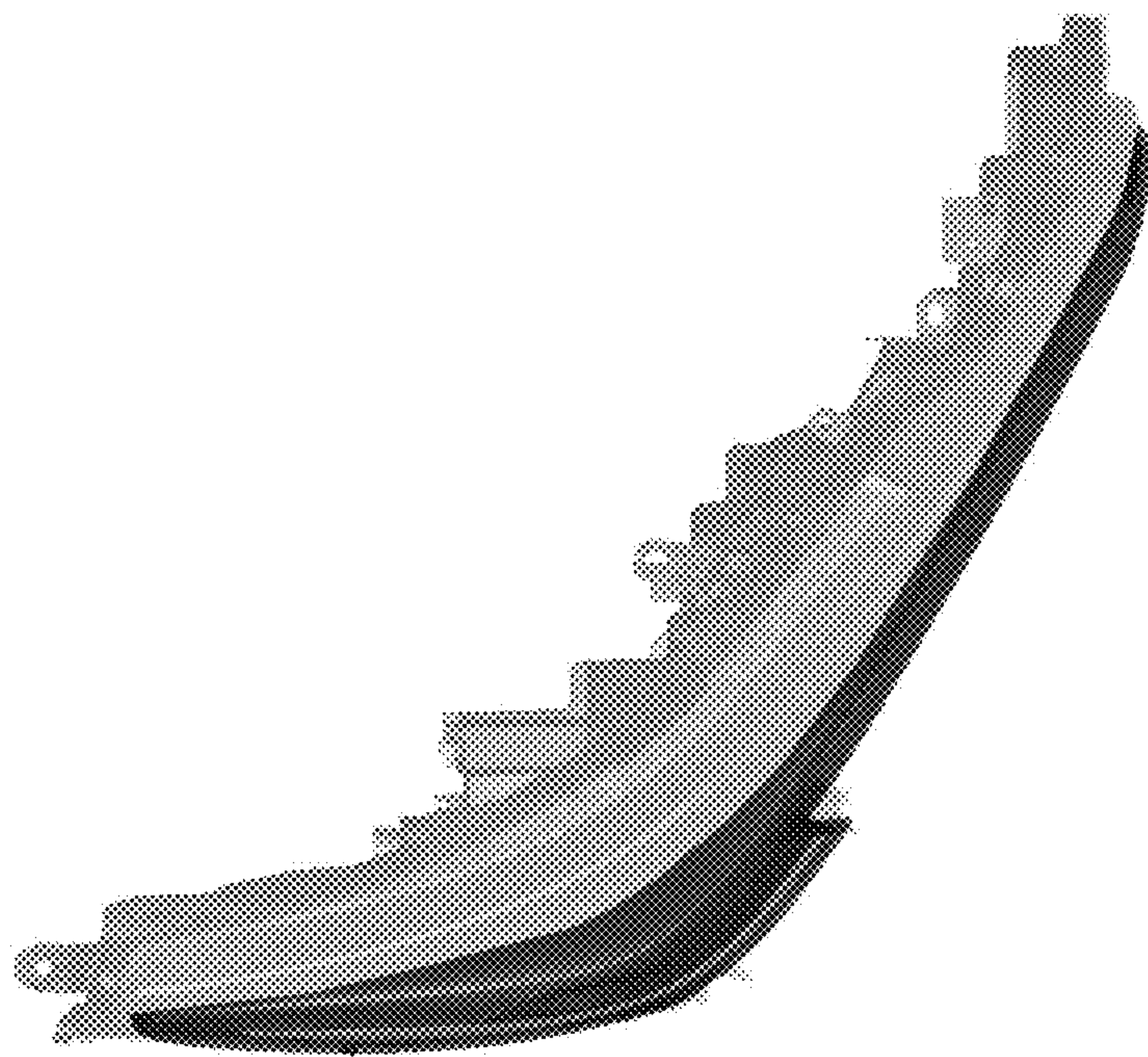

FIG. 6

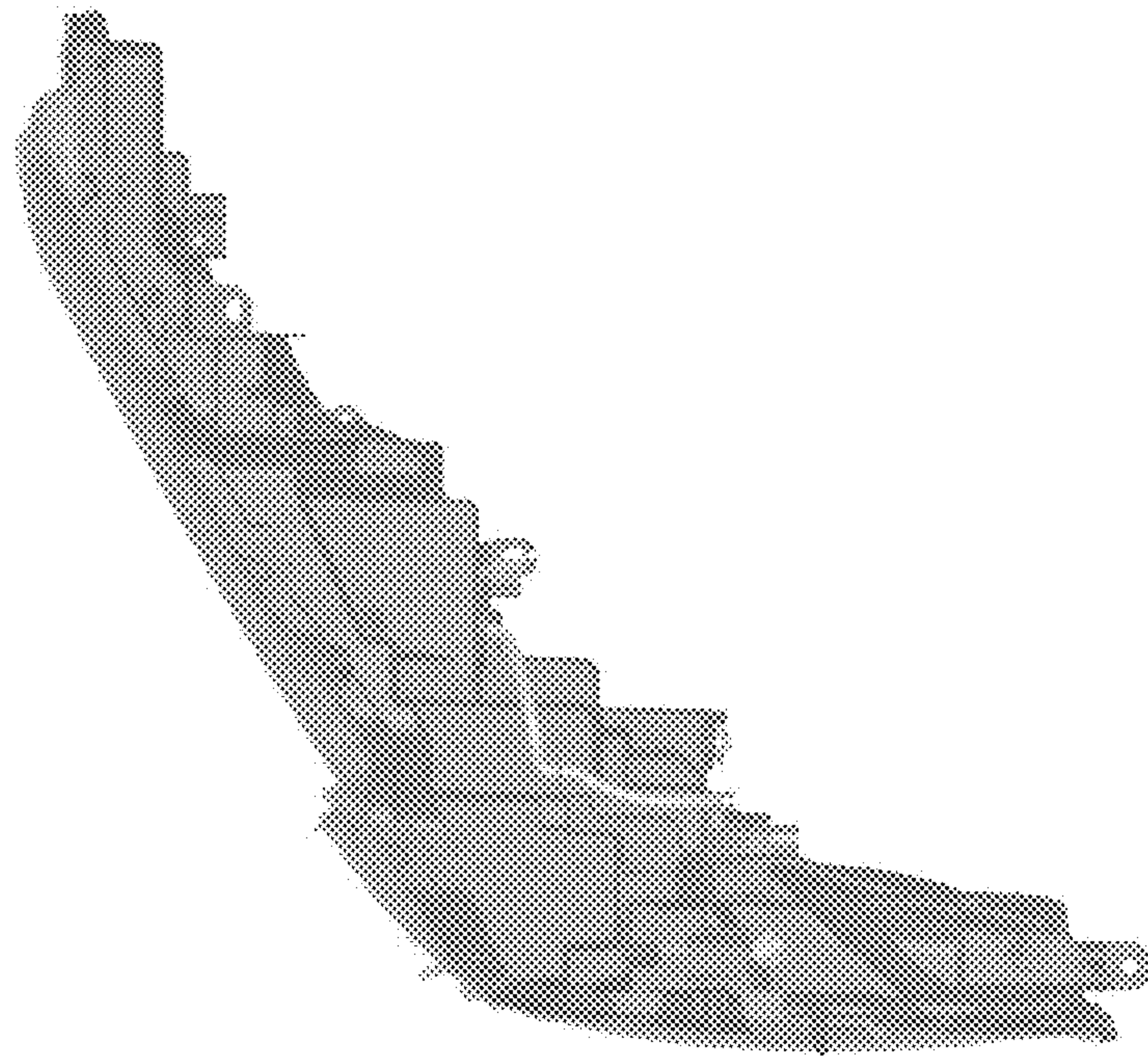

FIG. 7

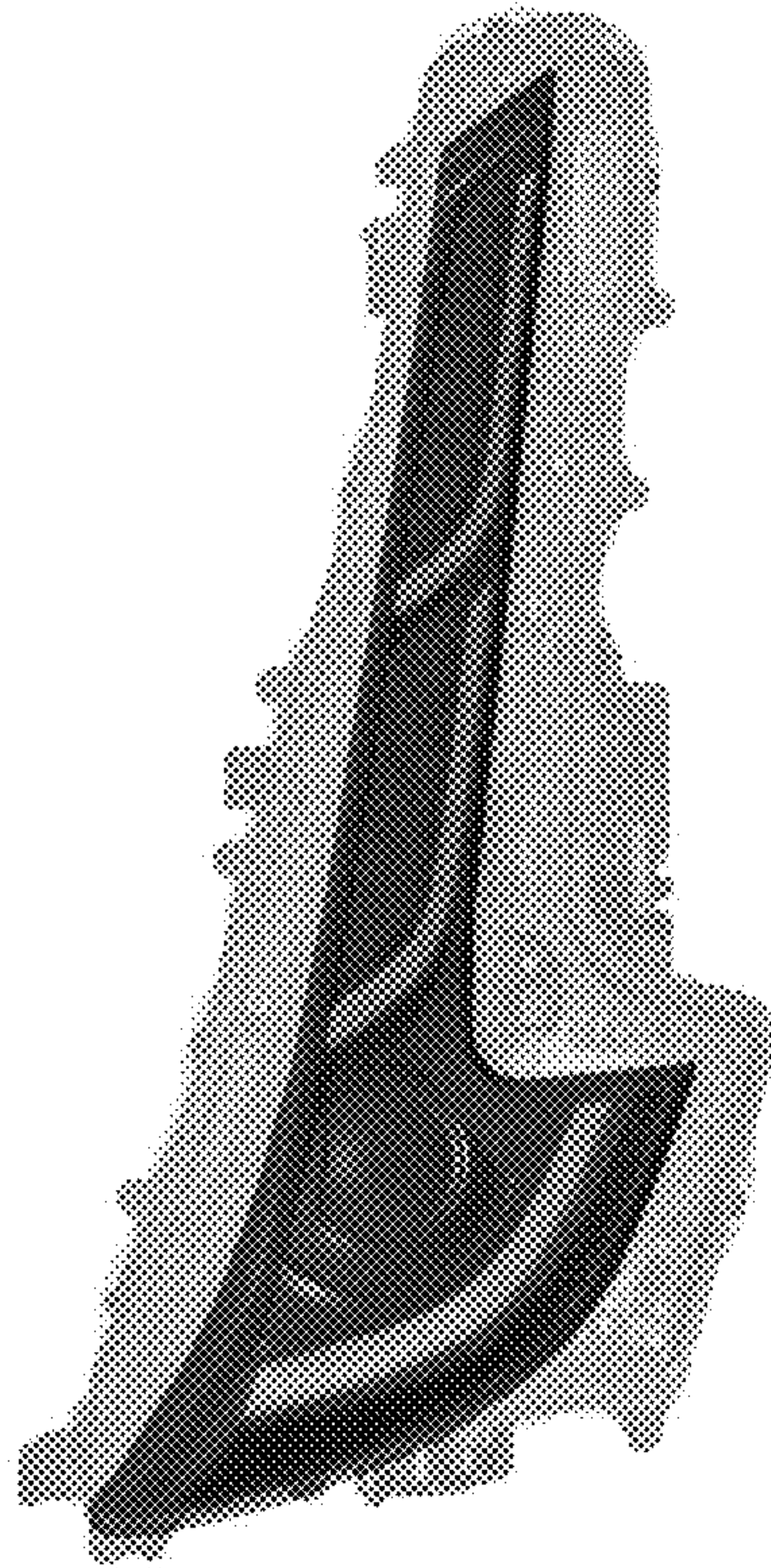

FIG. 8

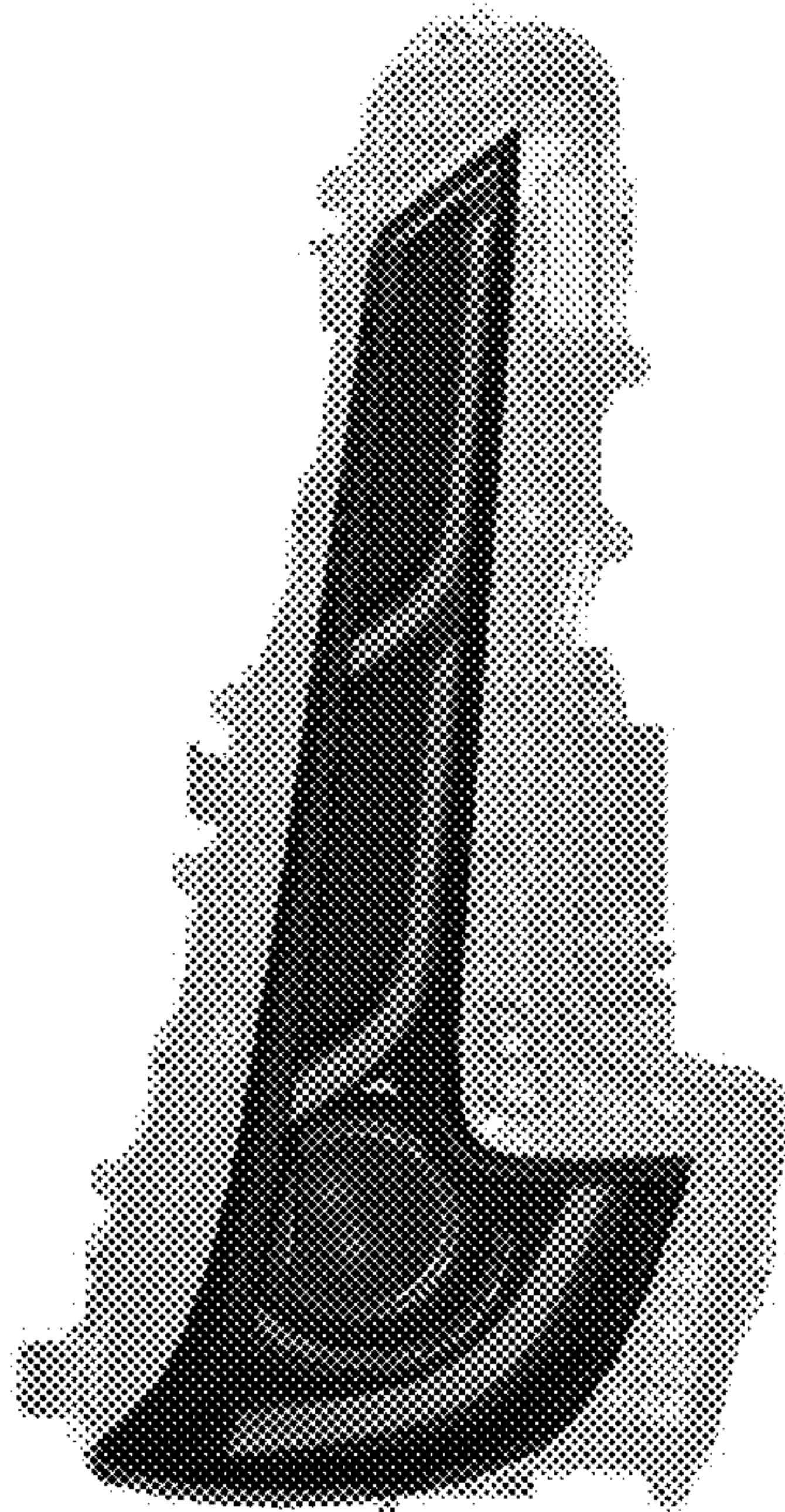

FIG. 9

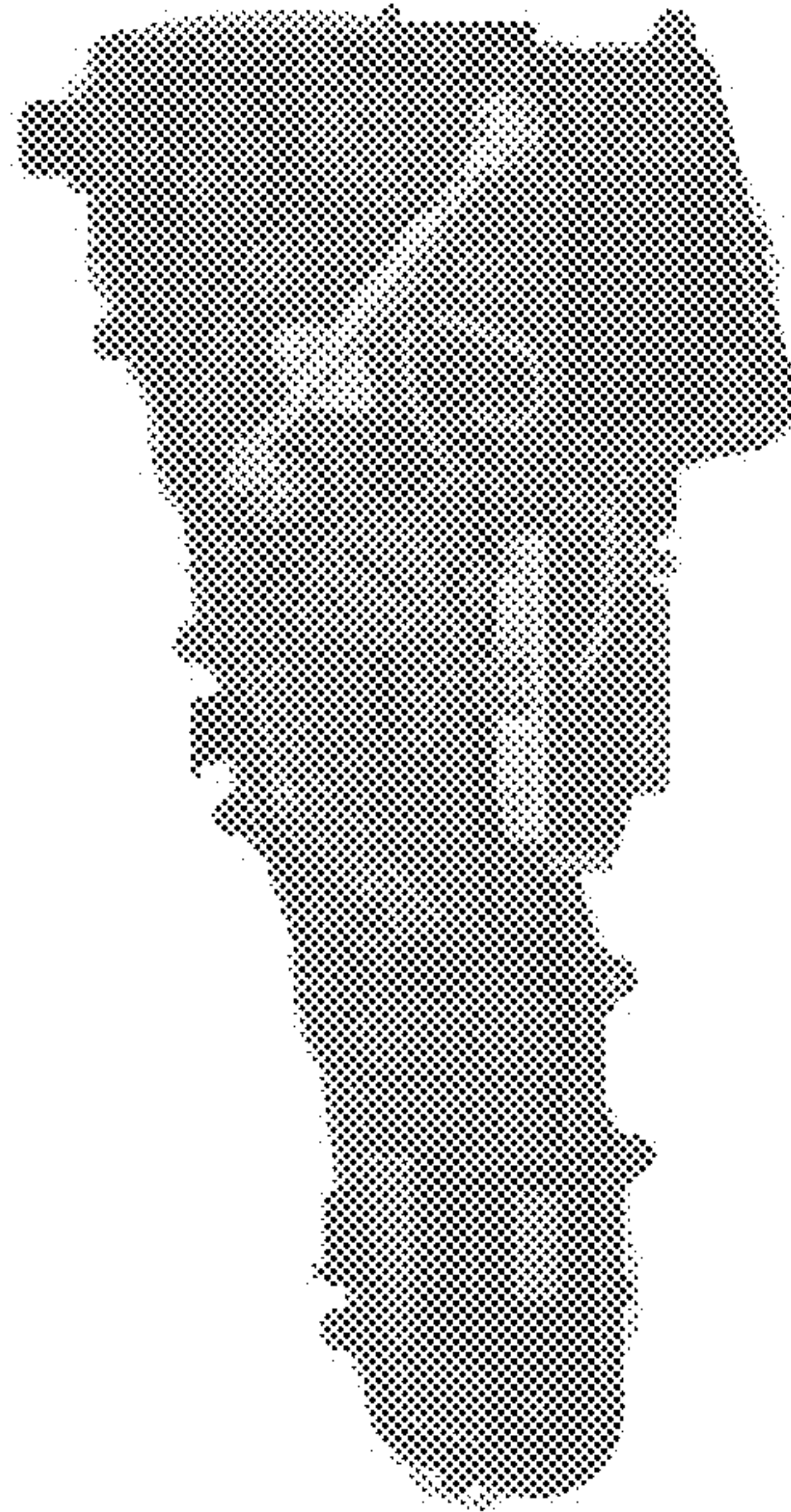

FIG. 10

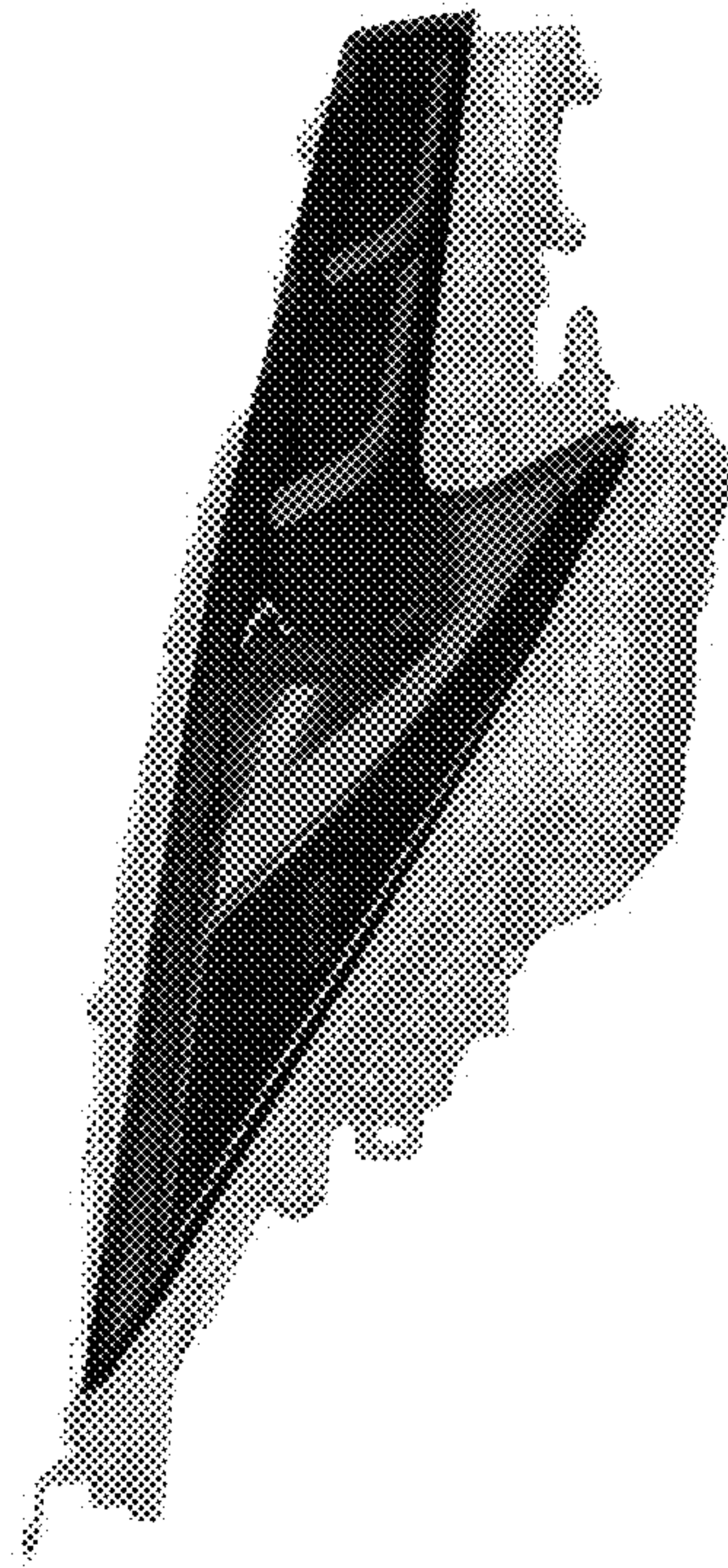

FIG. 11

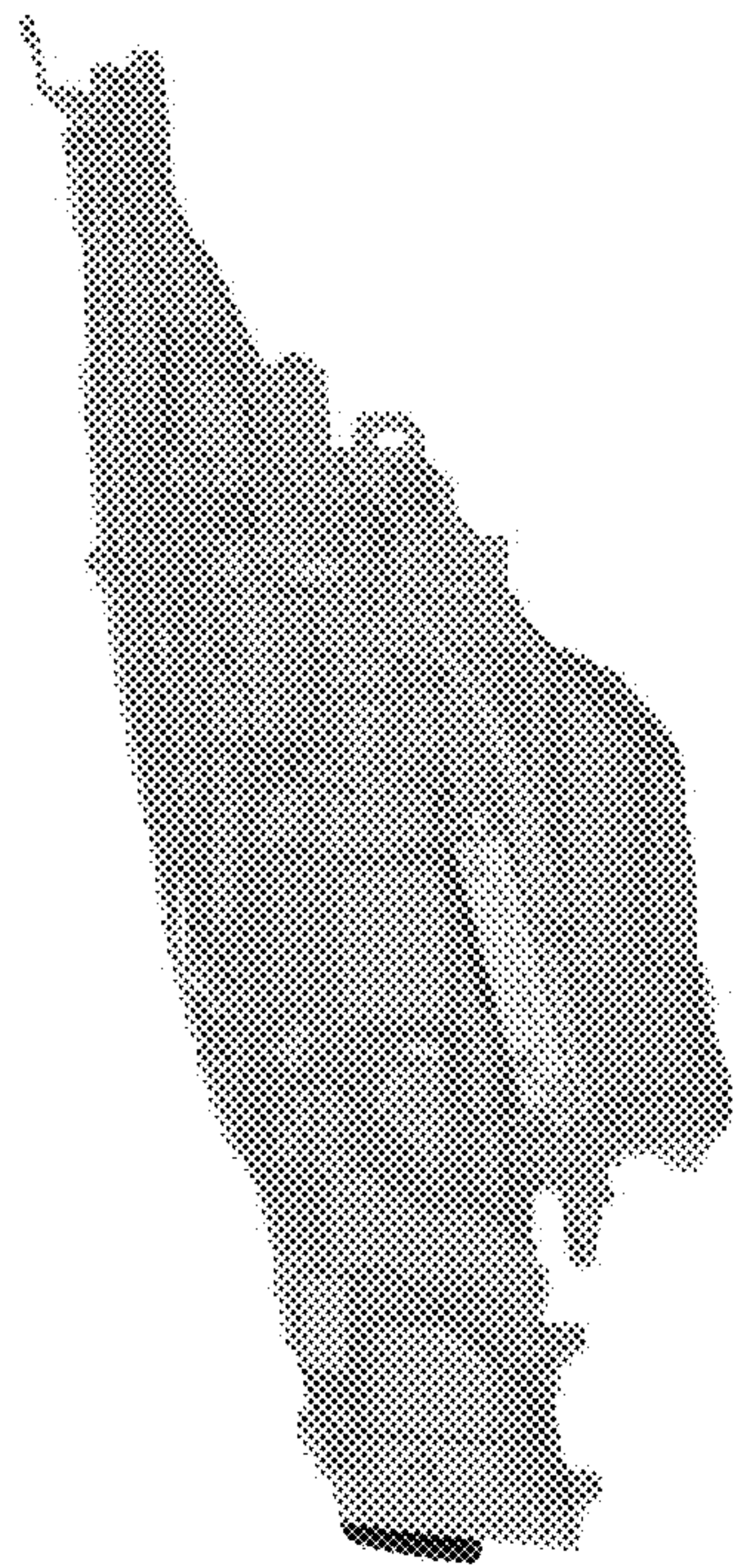

FIG. 12

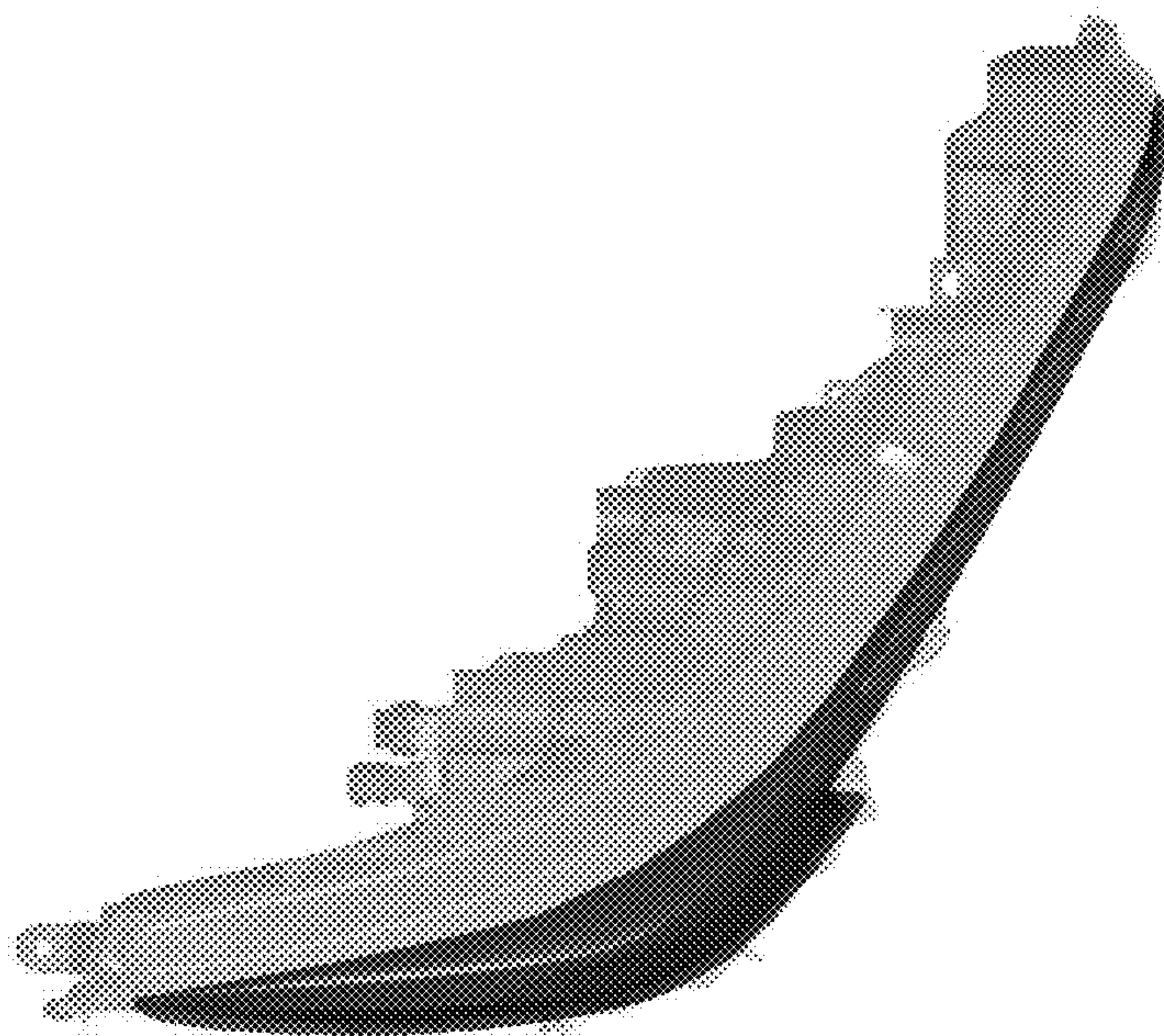

FIG. 13

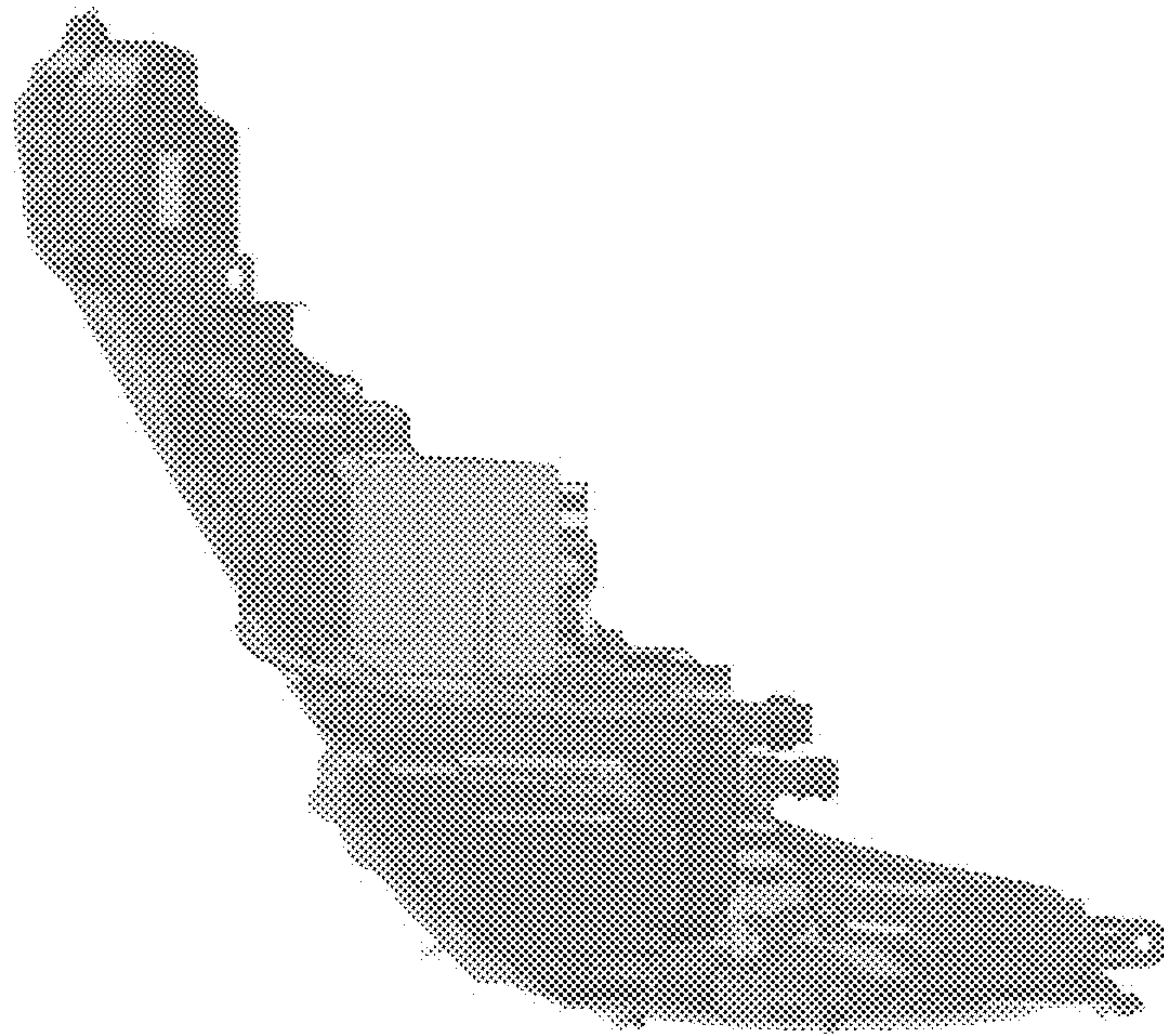

FIG. 14

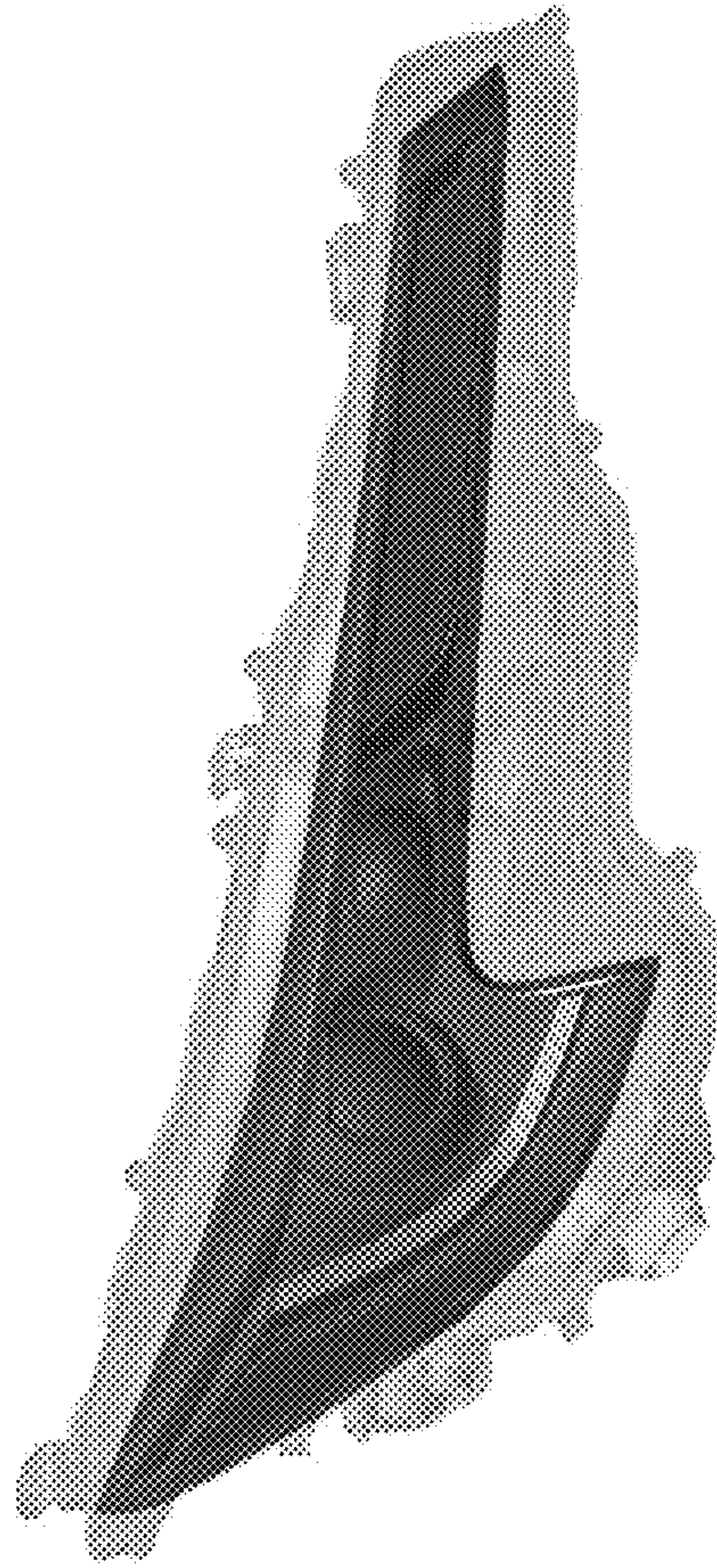

FIG. 15

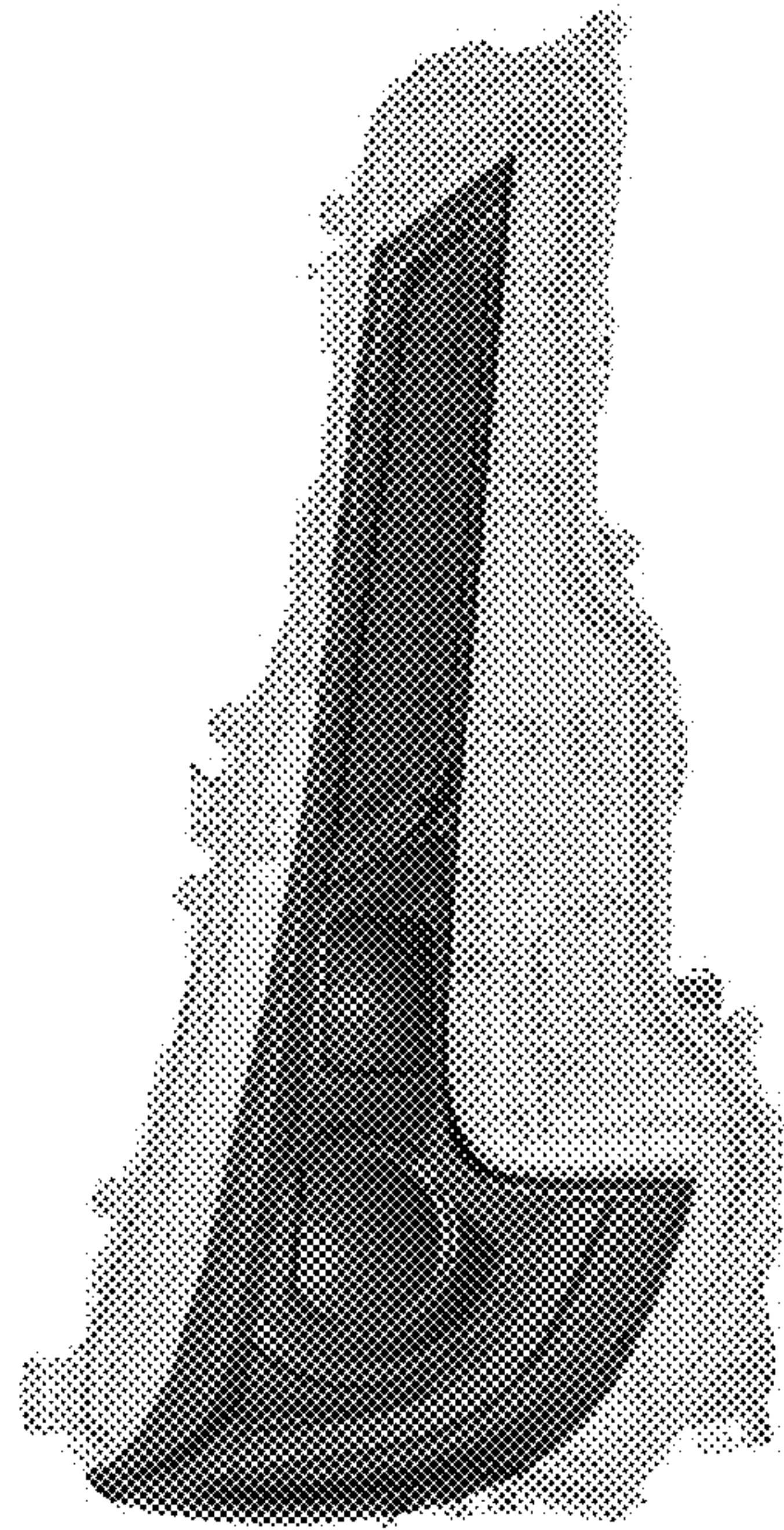

FIG. 16

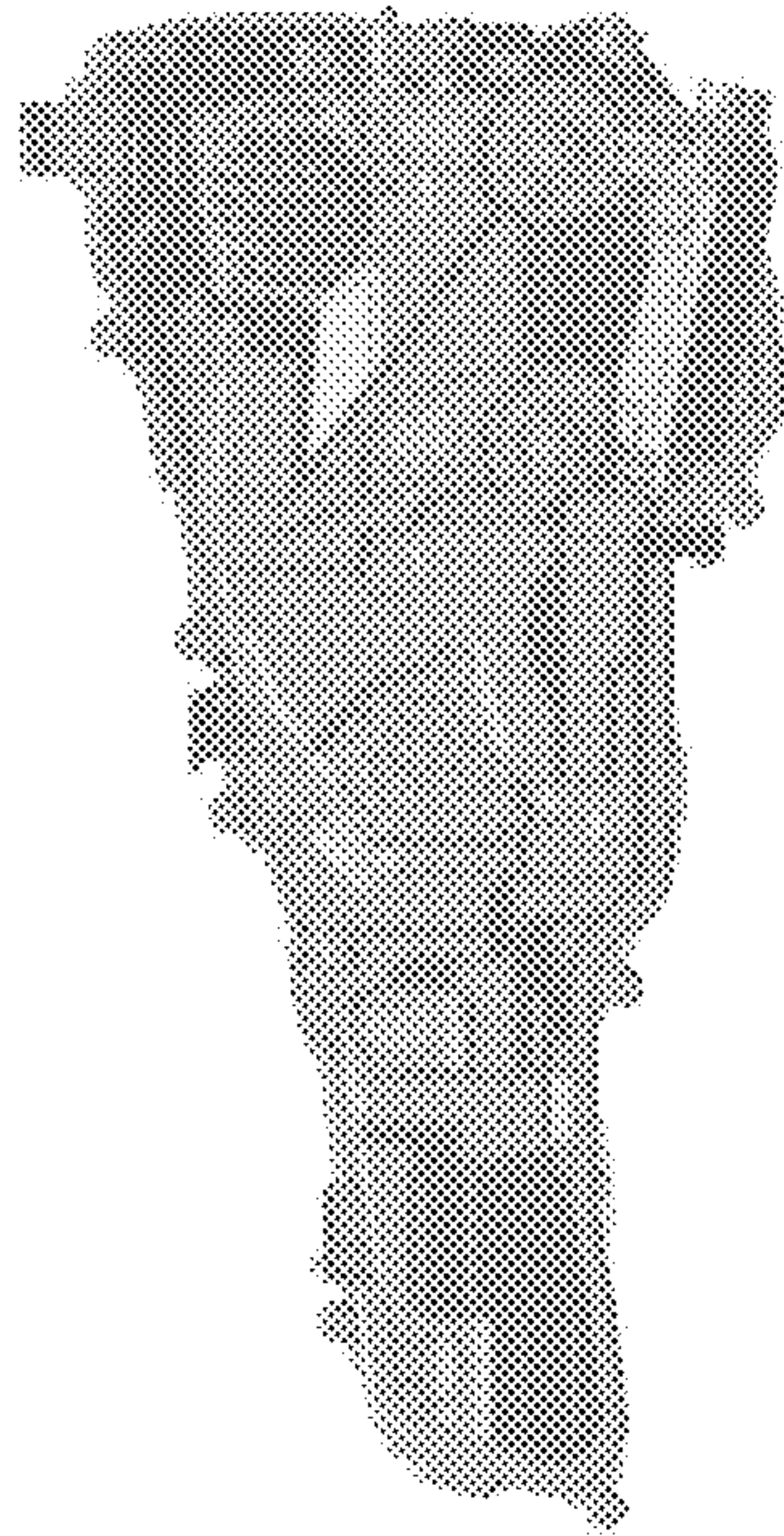

FIG. 17

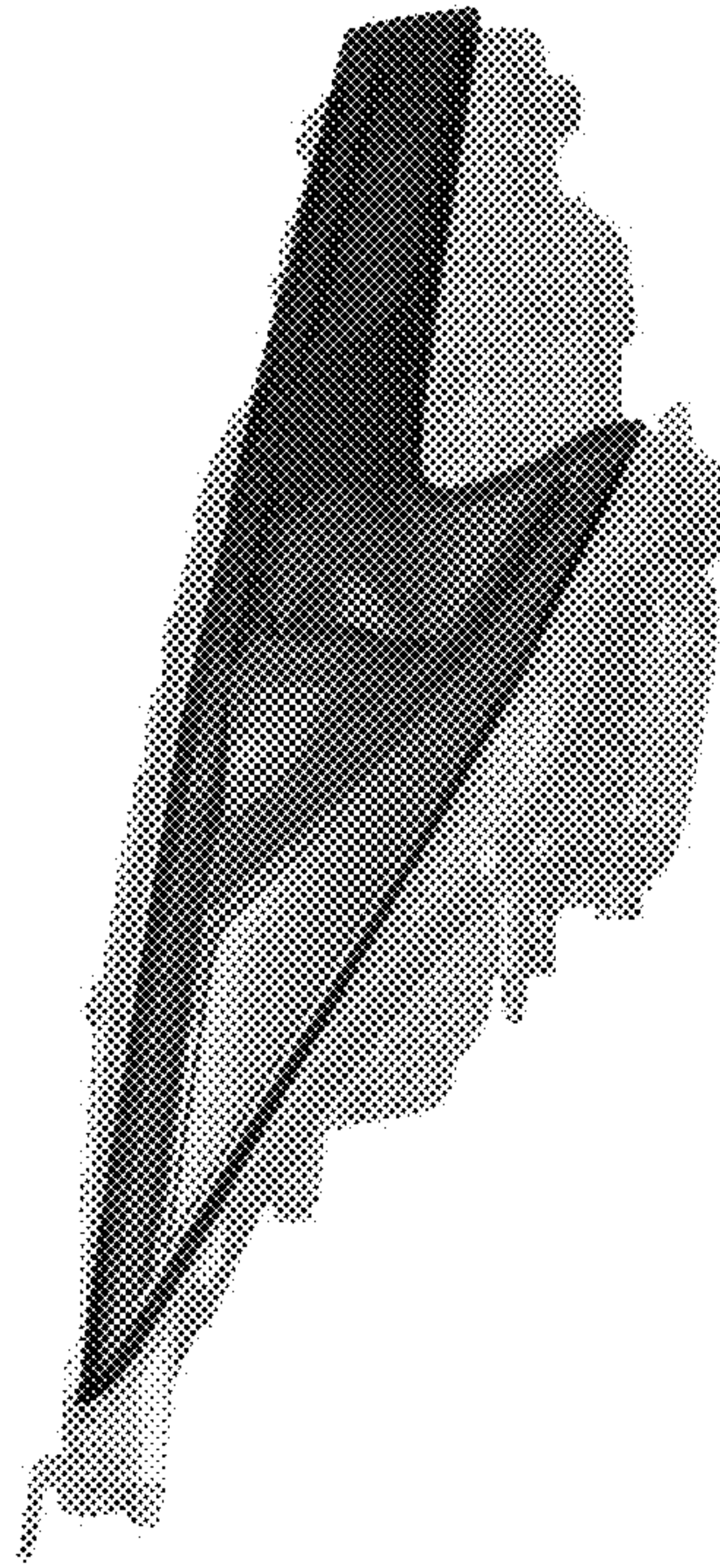

FIG. 18

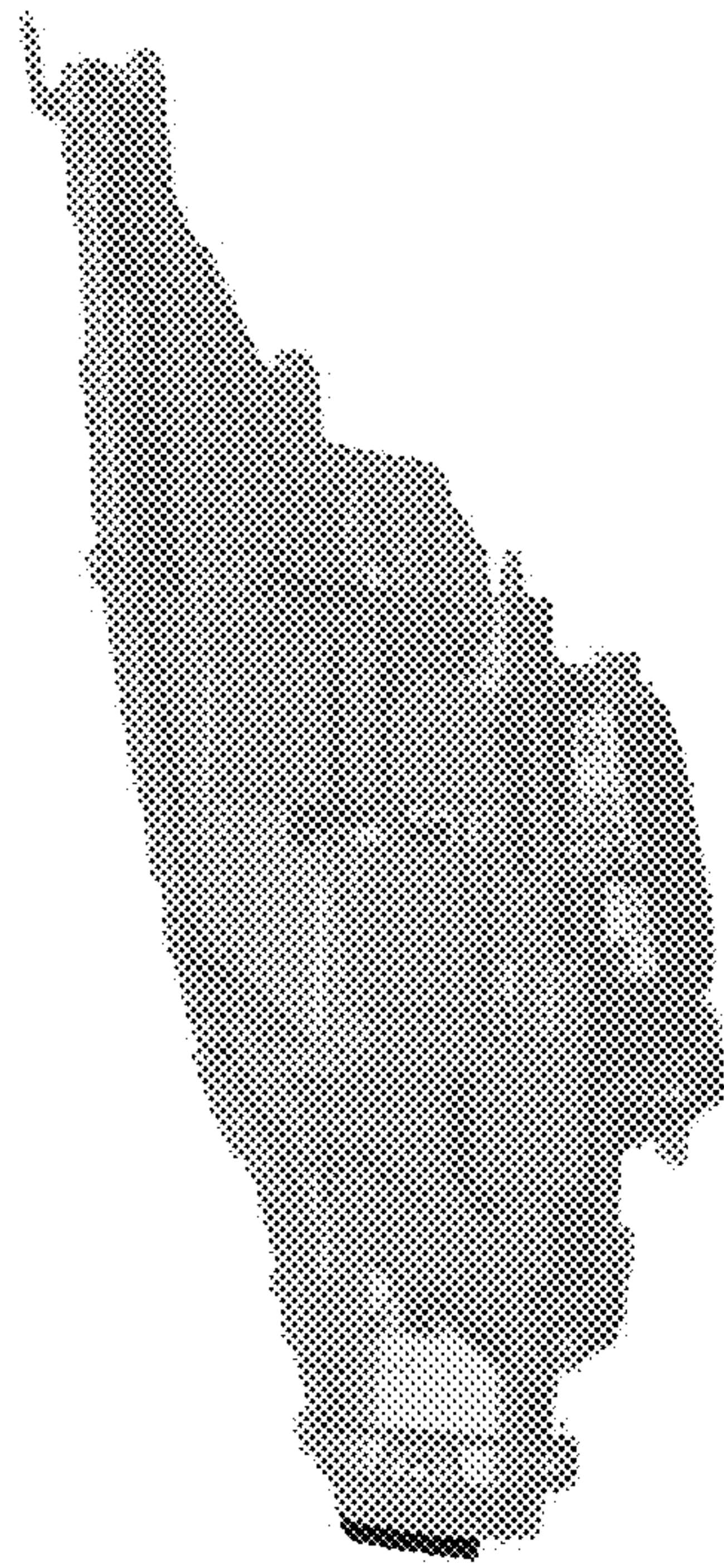

FIG. 19

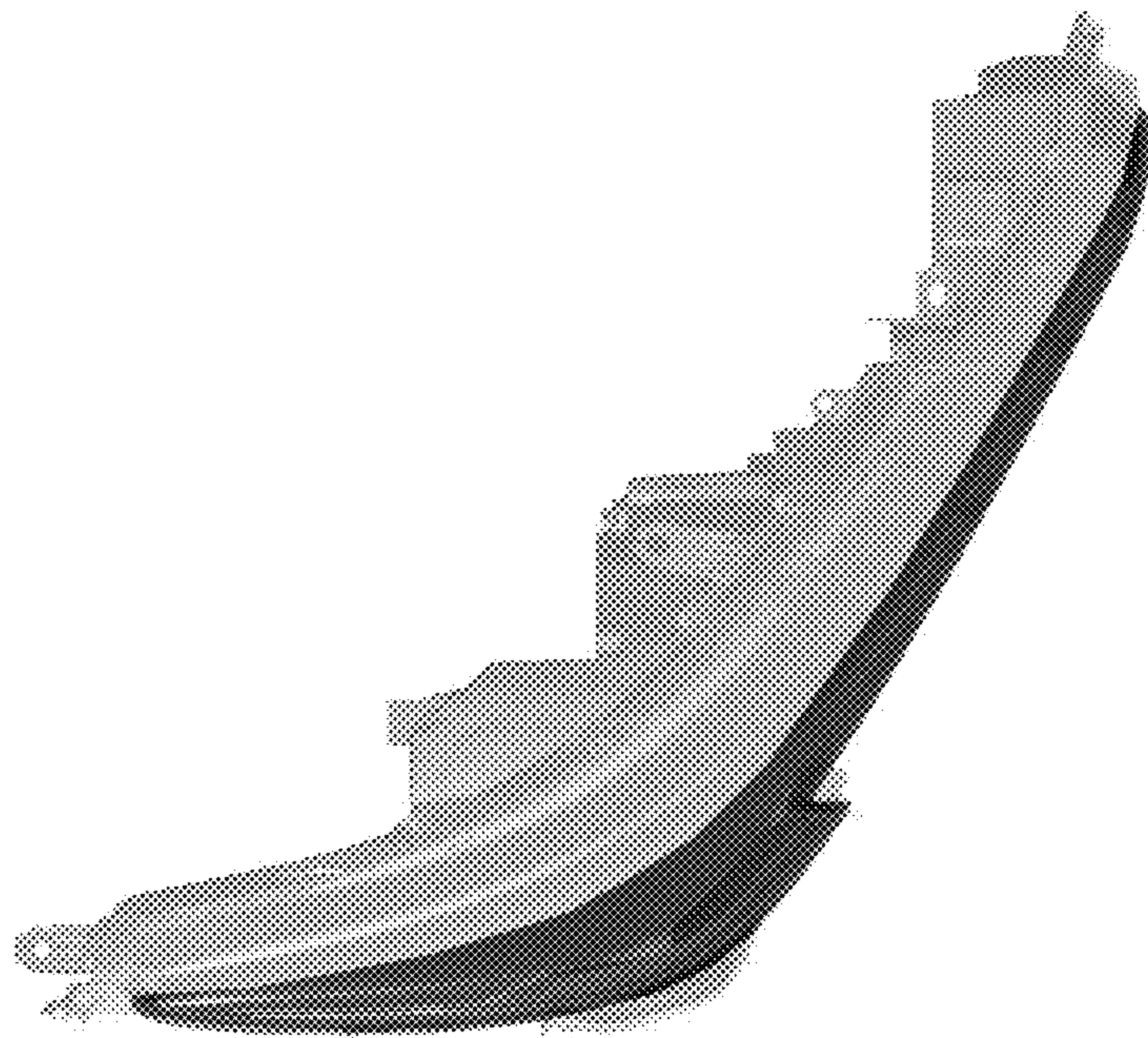

FIG. 20

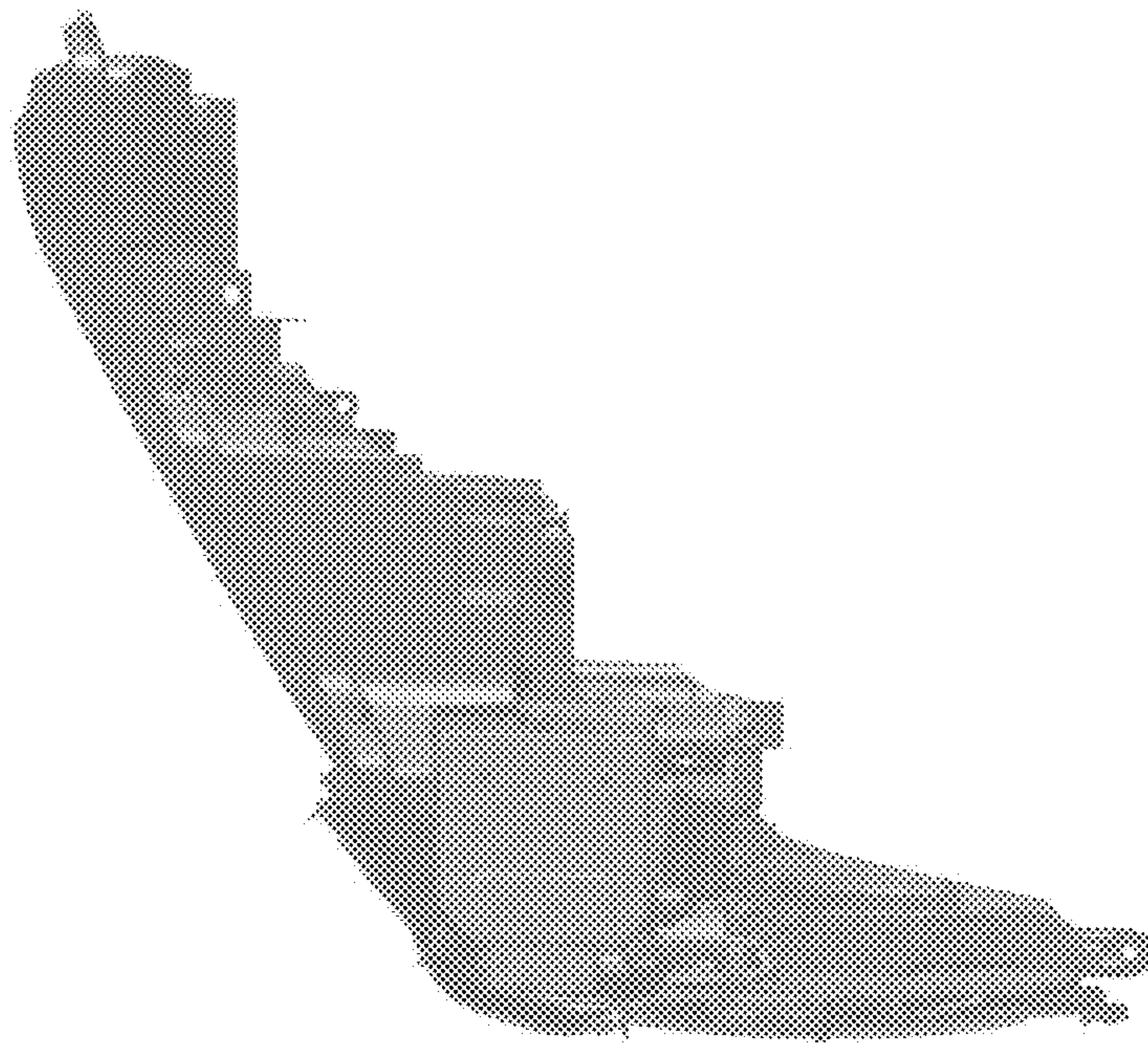

FIG. 21