



US00D869018S

(12) **United States Design Patent** (10) **Patent No.:** **US D869,018 S**  
**Dewitt et al.** (45) **Date of Patent:** **\*\* Dec. 3, 2019**

(54) **VEHICLE TAIL LAMP**

(71) Applicant: **Ford Global Technologies, LLC**,  
Dearborn, MI (US)

(72) Inventors: **David Dewitt**, Docklands (AU); **Todd Willing**, East Melbourne (AU); **Max Wolff**, Birmingham, MI (US); **Pedro Guarinon**, Melbourne (AU); **Mark Wright**, Nunawading (AU)

(73) Assignee: **Ford Global Technologies, LLC**,  
Dearborn, MI (US)

(\*\*) Term: **15 Years**

(21) Appl. No.: **29/632,605**

(22) Filed: **Jan. 9, 2018**

(51) **LOC (12) Cl.** ..... **26-06**

(52) **U.S. Cl.**  
USPC ..... **D26/28**

(58) **Field of Classification Search**  
USPC ..... D26/28–36, 139  
(Continued)

(56) **References Cited**

U.S. PATENT DOCUMENTS

D592,332 S \* 5/2009 Hsu ..... D26/28  
D631,177 S \* 1/2011 Yang ..... D26/28  
(Continued)

*Primary Examiner* — Marcus A Jackson

(74) *Attorney, Agent, or Firm* — Vichit Chea

(57) **CLAIM**

The ornamental design for a vehicle tail lamp, as shown and described.

**DESCRIPTION**

FIG. 1 is a front elevational view of a vehicle tail lamp, showing our new design;

FIG. 2 is a rear elevational view thereof;  
FIG. 3 is a left side elevational view thereof;  
FIG. 4 is a right side elevational view thereof;  
FIG. 5 is a top plan view thereof;  
FIG. 6 is a bottom plan view thereof;  
FIG. 7 is a top, front, and left side perspective view thereof;  
and  
FIG. 8 is a bottom, front, and left side perspective view thereof.  
FIG. 9 is a front elevational view of a second embodiment of a vehicle tail lamp, showing our new design;  
FIG. 10 is a rear elevational view thereof;  
FIG. 11 is a left side elevational view thereof;  
FIG. 12 is a right side elevational view thereof;  
FIG. 13 is a top plan view thereof;  
FIG. 14 is a bottom plan view thereof;  
FIG. 15 is a top, front, and left side perspective view thereof;  
and  
FIG. 16 is a bottom, front, and left side perspective view thereof.  
FIG. 17 is a front elevational view of a third embodiment of a vehicle tail lamp, showing our new design;  
FIG. 18 is a rear elevational view thereof;  
FIG. 19 is a left side elevational view thereof;  
FIG. 20 is a right side elevational view thereof;  
FIG. 21 is a top plan view thereof;  
FIG. 22 is a bottom plan view thereof;  
FIG. 23 is a top, front, and left side perspective view thereof;  
and  
FIG. 24 is a bottom, front, and left side perspective view thereof.  
FIG. 25 is a front elevational view of a fourth embodiment of a vehicle tail lamp, showing our new design;  
FIG. 26 is a rear elevational view thereof;  
FIG. 27 is a left side elevational view thereof;  
FIG. 28 is a right side elevational view thereof;  
FIG. 29 is a top plan view thereof;  
FIG. 30 is a bottom plan view thereof;  
FIG. 31 is a top, front, and left side perspective view thereof;  
and  
FIG. 32 is a bottom, front, and left side perspective view thereof.

(Continued)

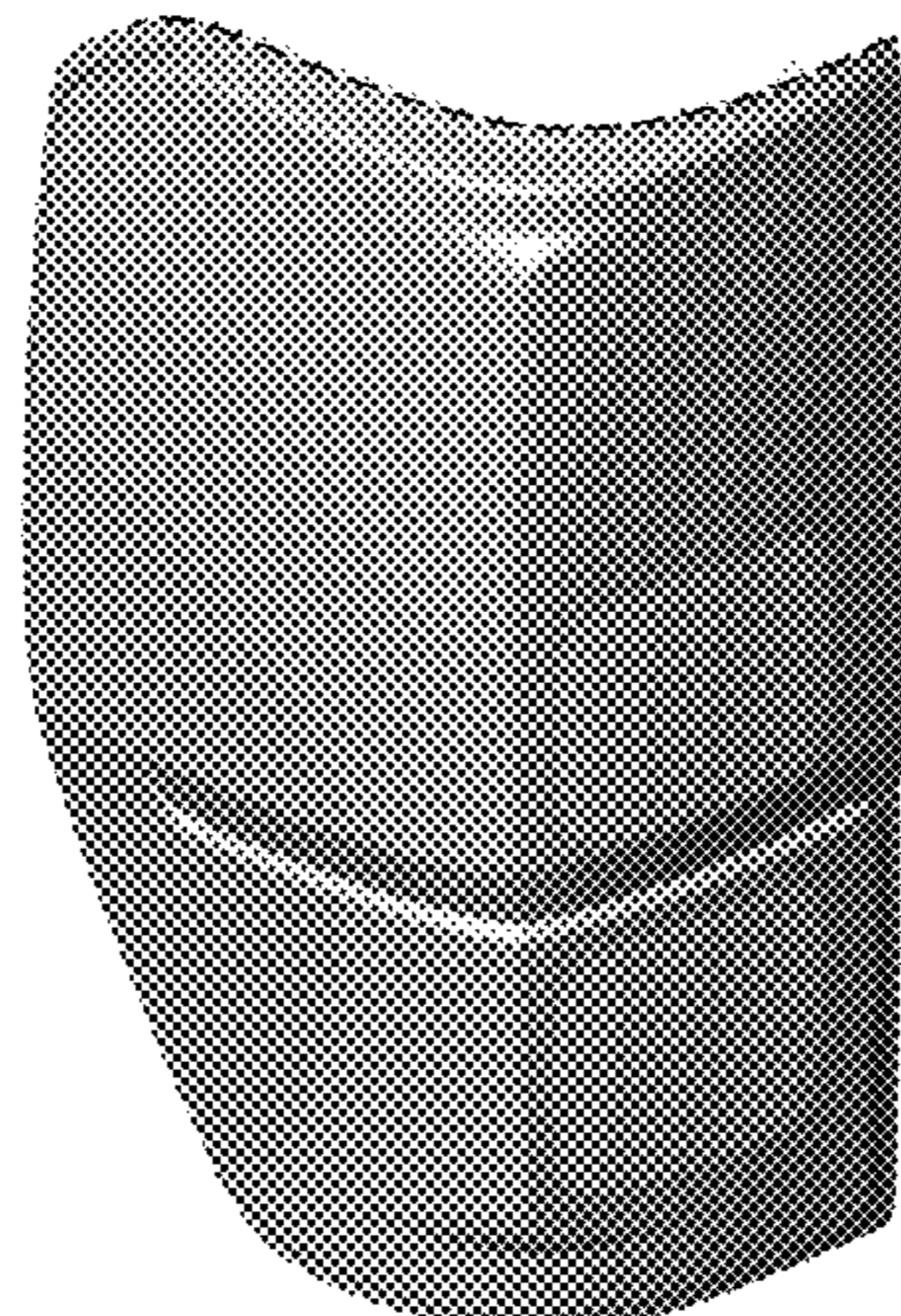

FIG. 33 is a front elevational view of a fifth embodiment of a vehicle tail lamp, showing our new design;  
FIG. 34 is a rear elevational view thereof;  
FIG. 35 is a left side elevational view thereof;  
FIG. 36 is a right side elevational view thereof;  
FIG. 37 is a top plan view thereof;  
FIG. 38 is a bottom plan view thereof;  
FIG. 39 is a top, front, and left side perspective view thereof;  
and  
FIG. 40 is a bottom, front, and left side perspective view thereof.  
FIG. 41 is a front elevational view of a sixth embodiment of a vehicle tail lamp, showing our new design;  
FIG. 42 is a rear elevational view thereof;  
FIG. 43 is a left side elevational view thereof;  
FIG. 44 is a right side elevational view thereof;  
FIG. 45 is a top plan view thereof;  
FIG. 46 is a bottom plan view thereof;  
FIG. 47 is a top, front, and left side perspective view thereof;  
and,  
FIG. 48 is a bottom, front, and left side perspective view thereof.

Any broken lines represent an internal boundary of the design; the line itself and the area within form no part of the claim.

**1 Claim, 48 Drawing Sheets**

(58) **Field of Classification Search**

CPC ..... F21S 48/00; F21S 48/10; F21S 48/225;  
F21S 48/1233; F21S 48/1266; F21S  
48/1388; F21S 48/2268; F21V 21/04;  
B60Q 9/13; B60Q 9/135; B60Q 9/1375  
See application file for complete search history.

(56) **References Cited**

U.S. PATENT DOCUMENTS

D637,320	S	*	5/2011	Yang	.....	D26/28
D731,099	S	*	6/2015	Thole	.....	D26/28
D775,384	S	*	12/2016	Lin	.....	D26/28
D775,385	S	*	12/2016	Lin	.....	D26/28

\* cited by examiner



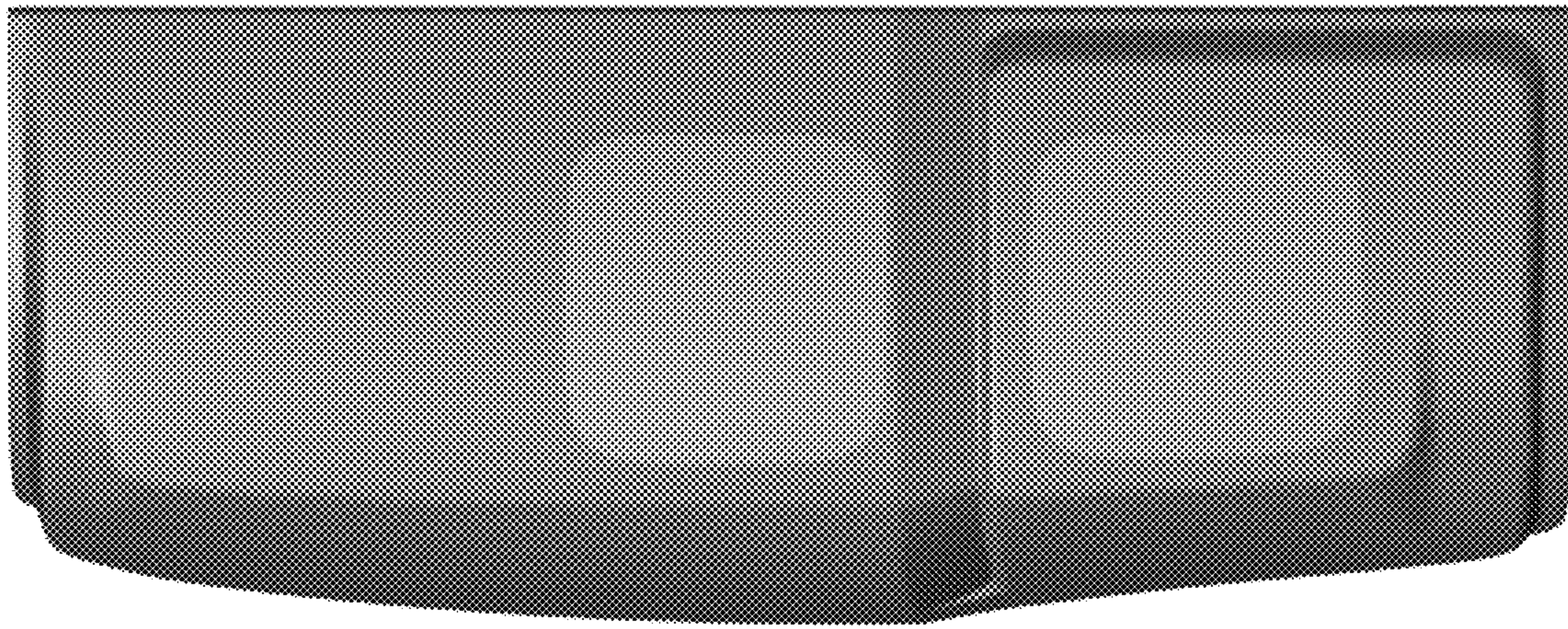

*Fig. 1*

Fig. 2

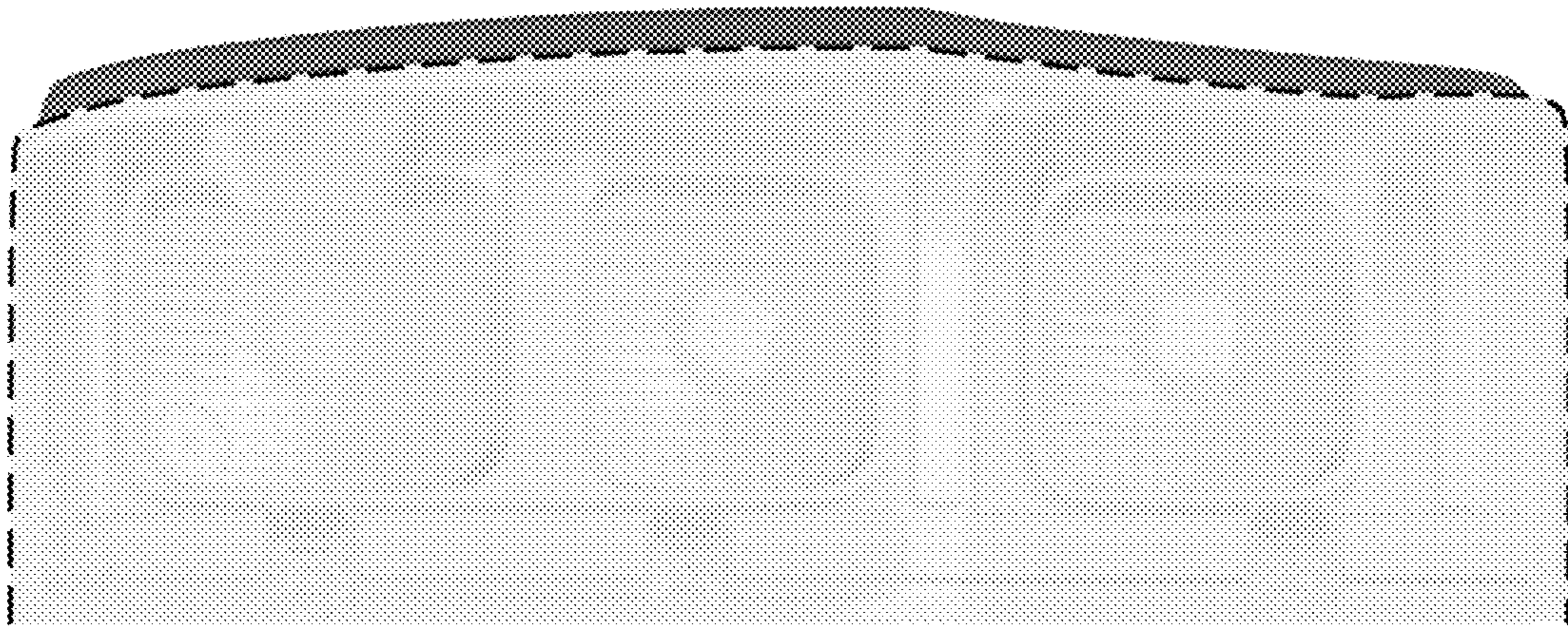



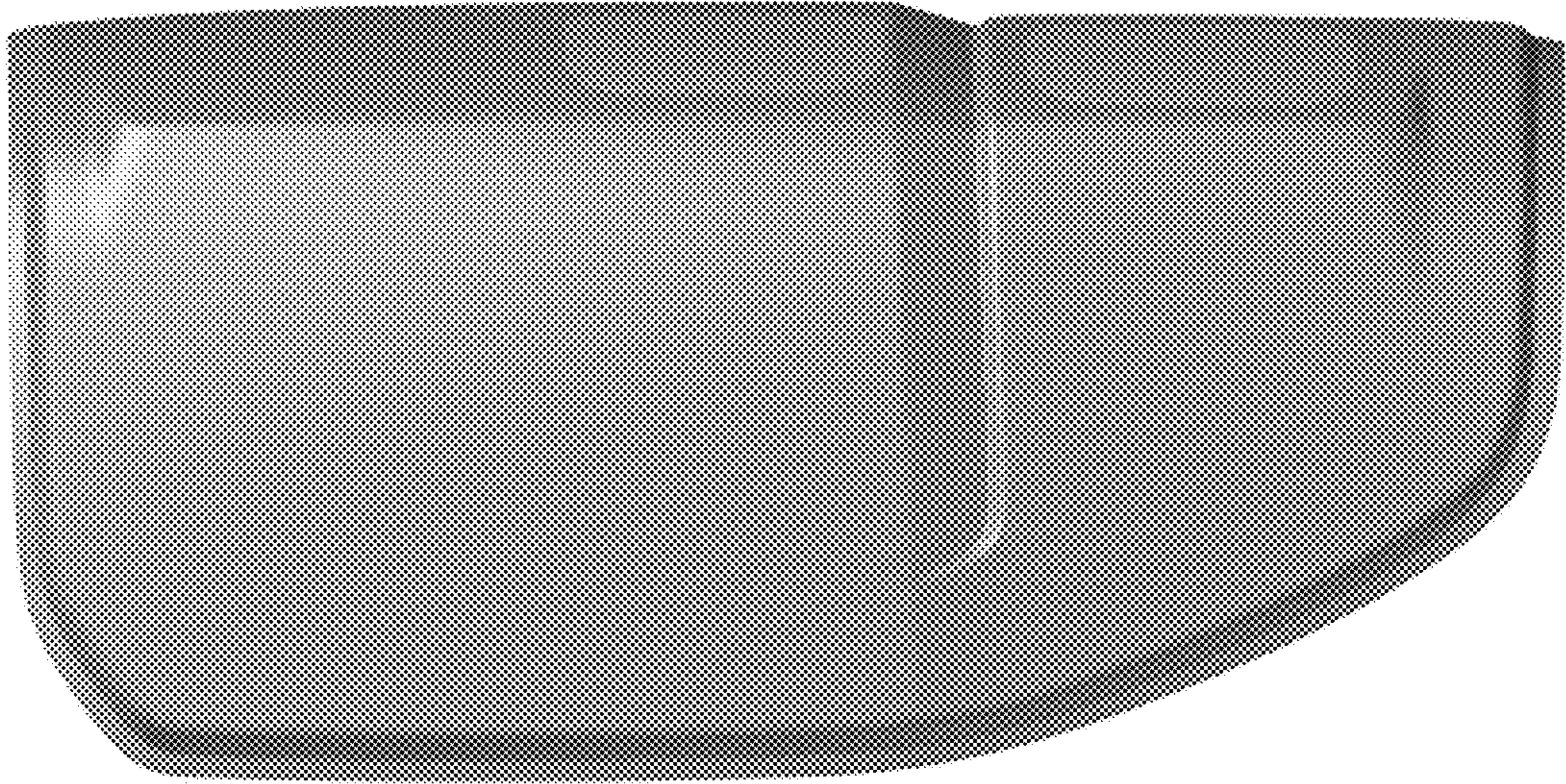

Fig. 3

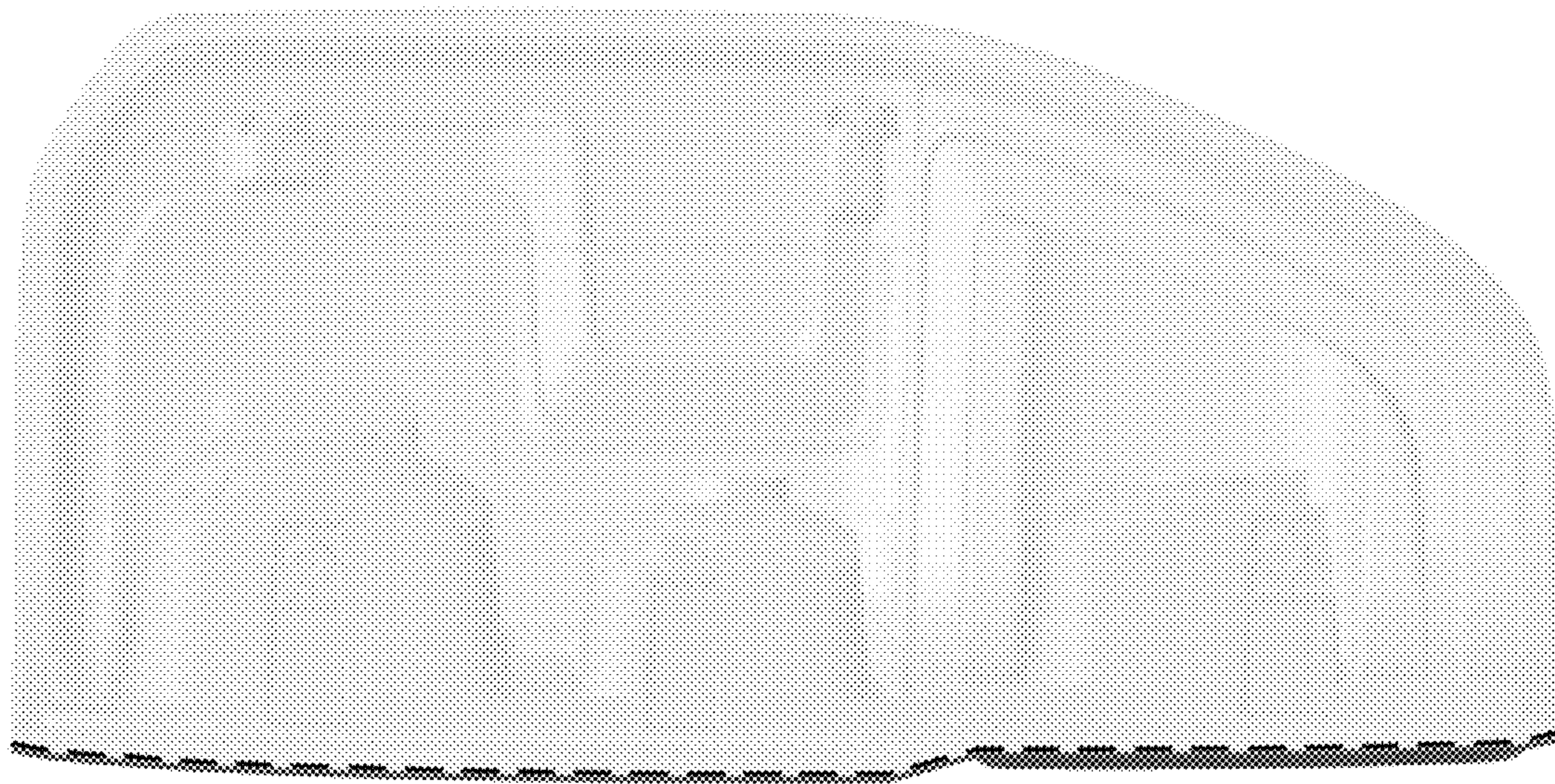

Fig. 4

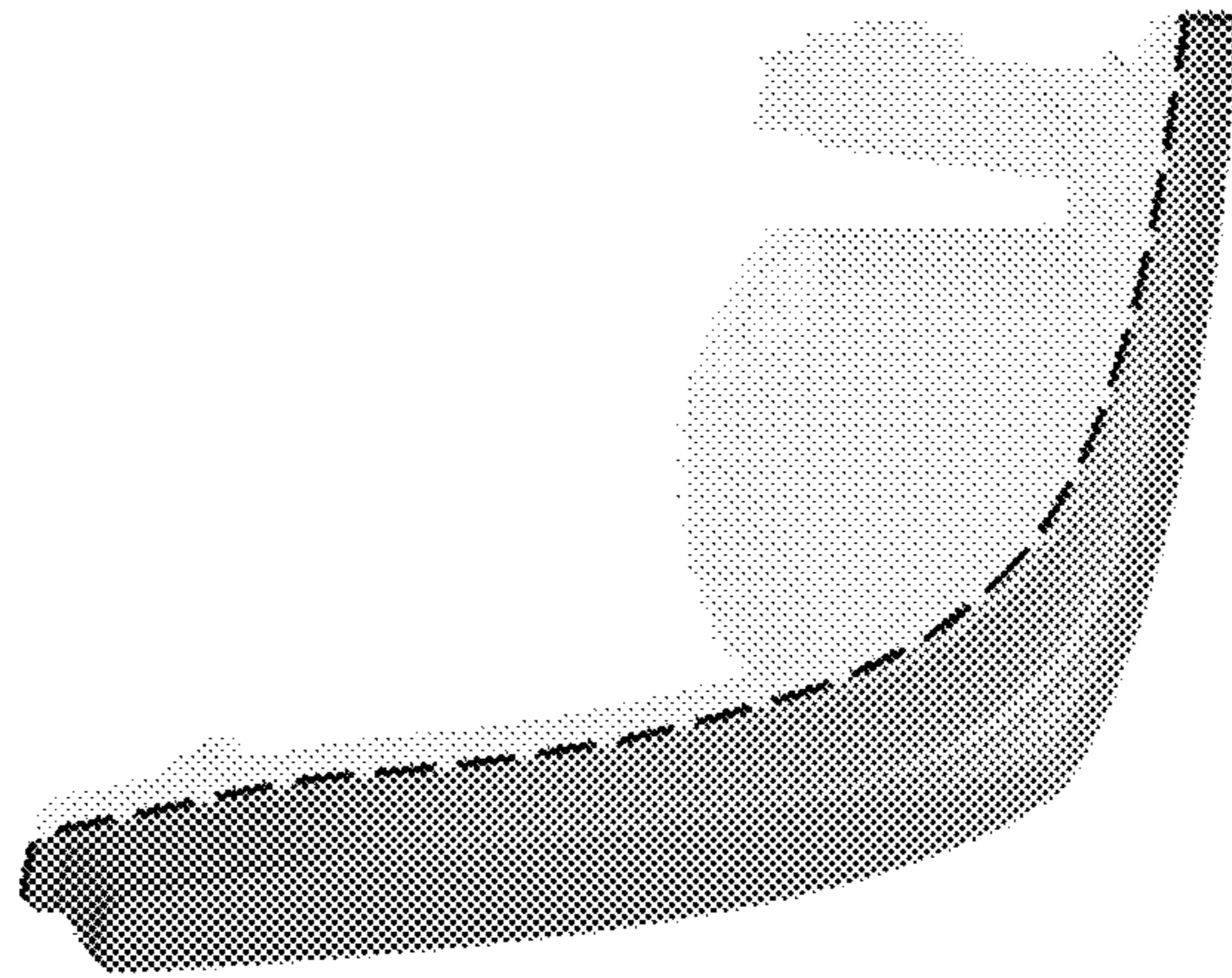
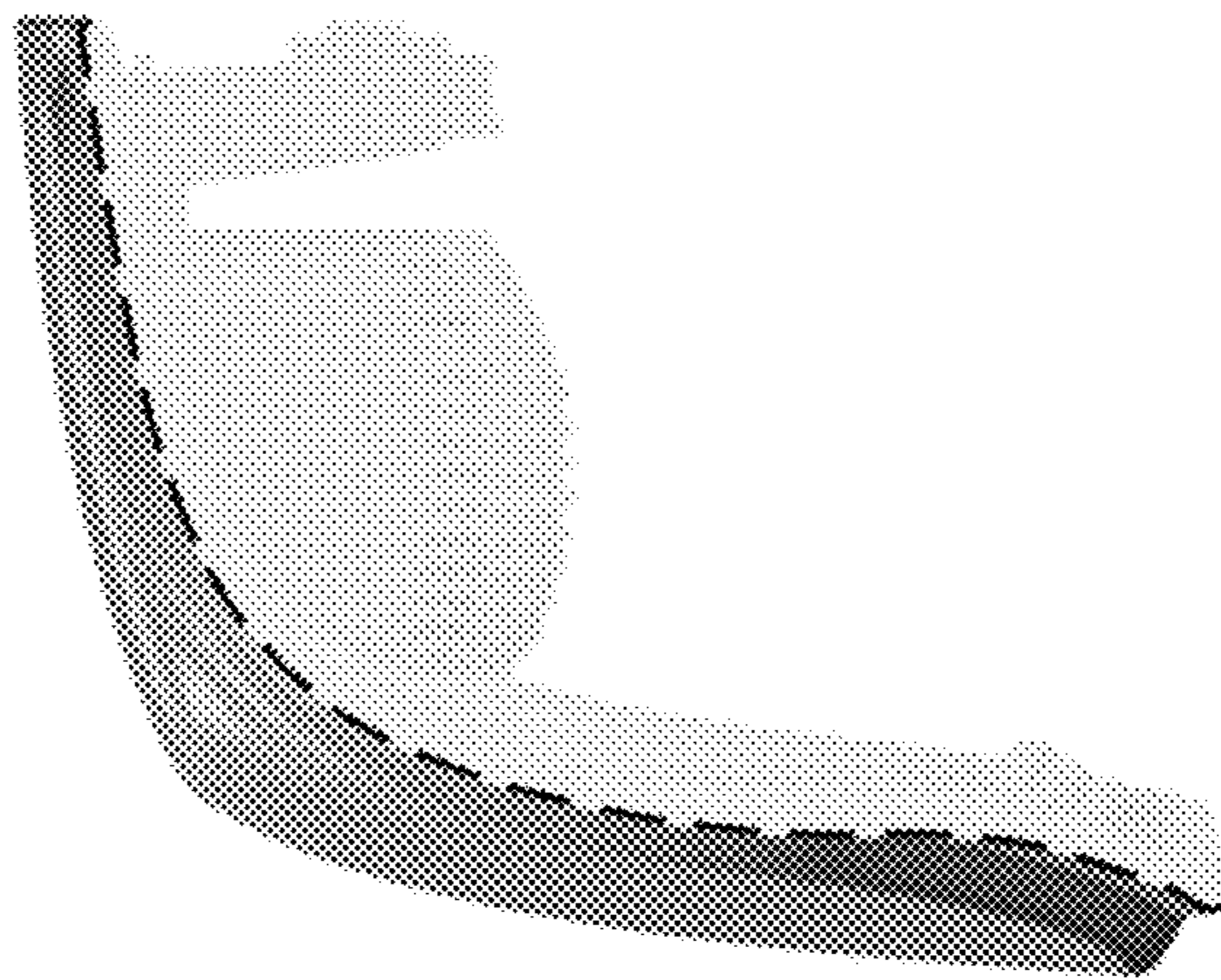

Fig. 5

Fig. 6





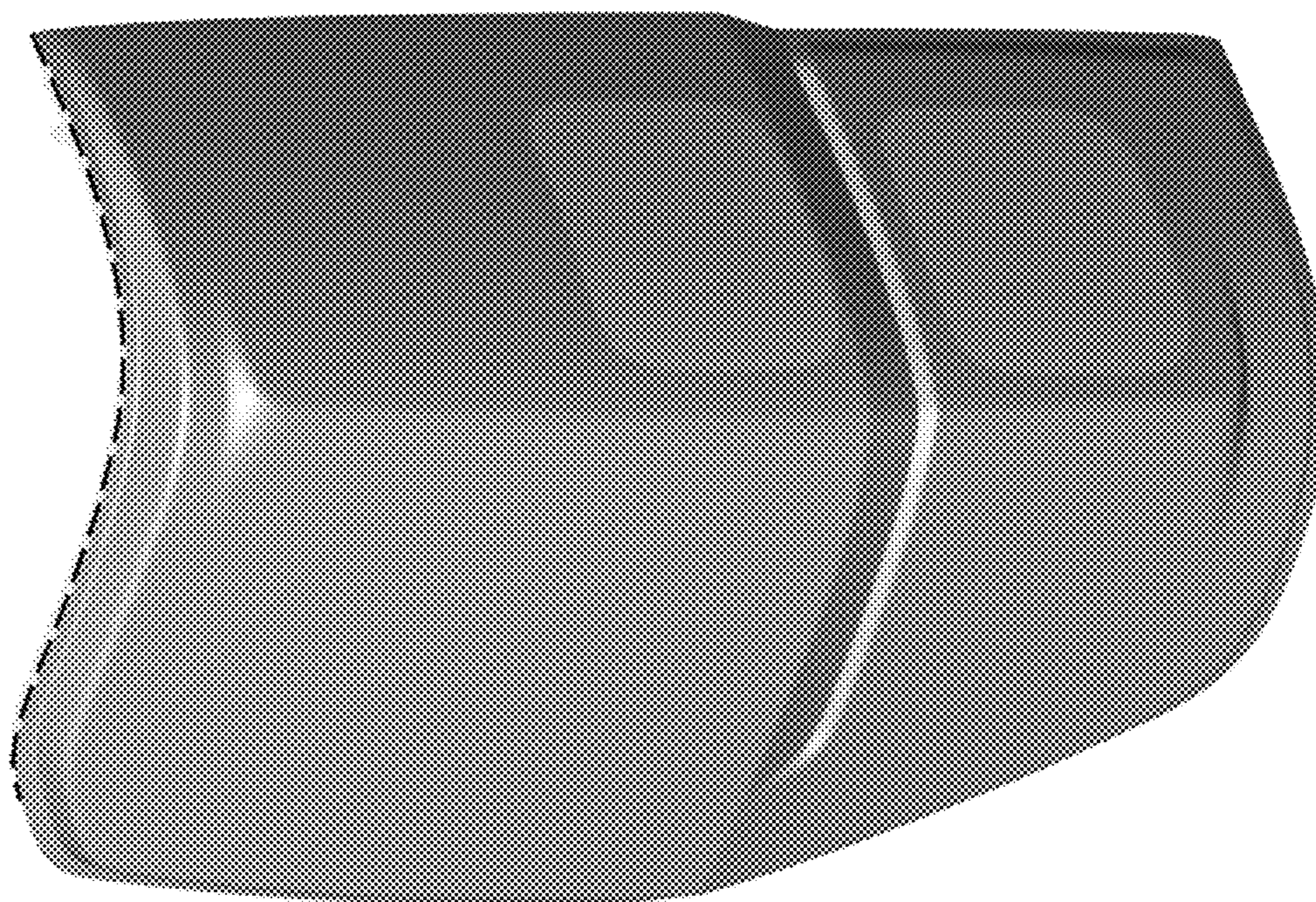
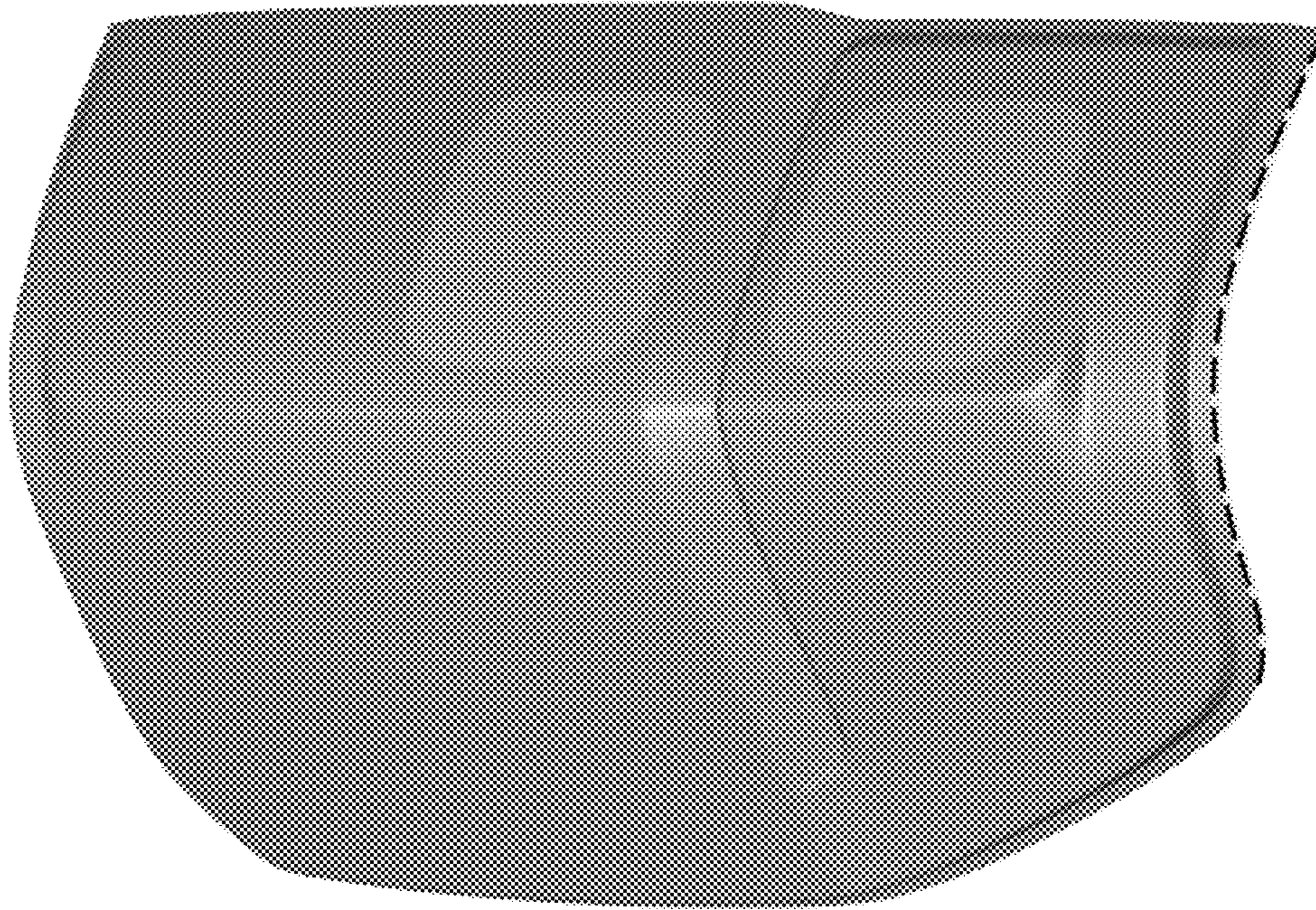

Fig. 7

Fig. 8





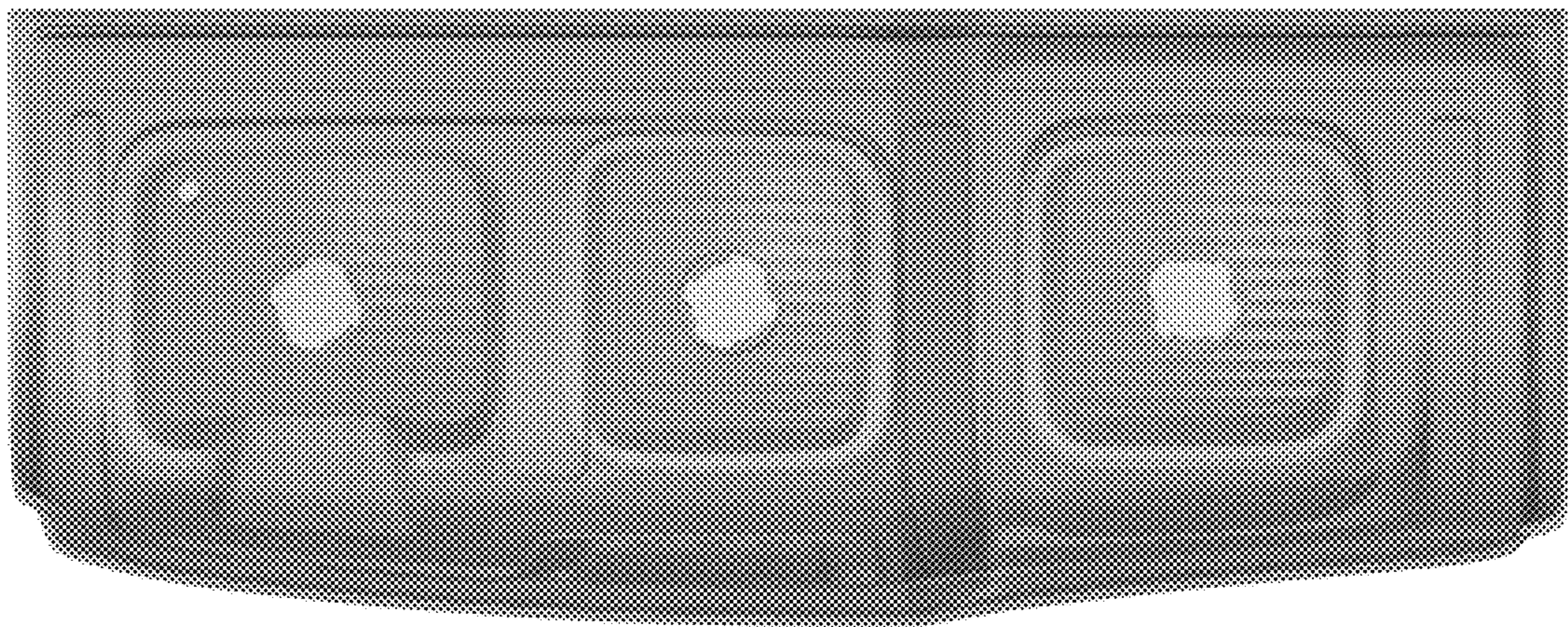

Fig. 9



*Fig. 10*

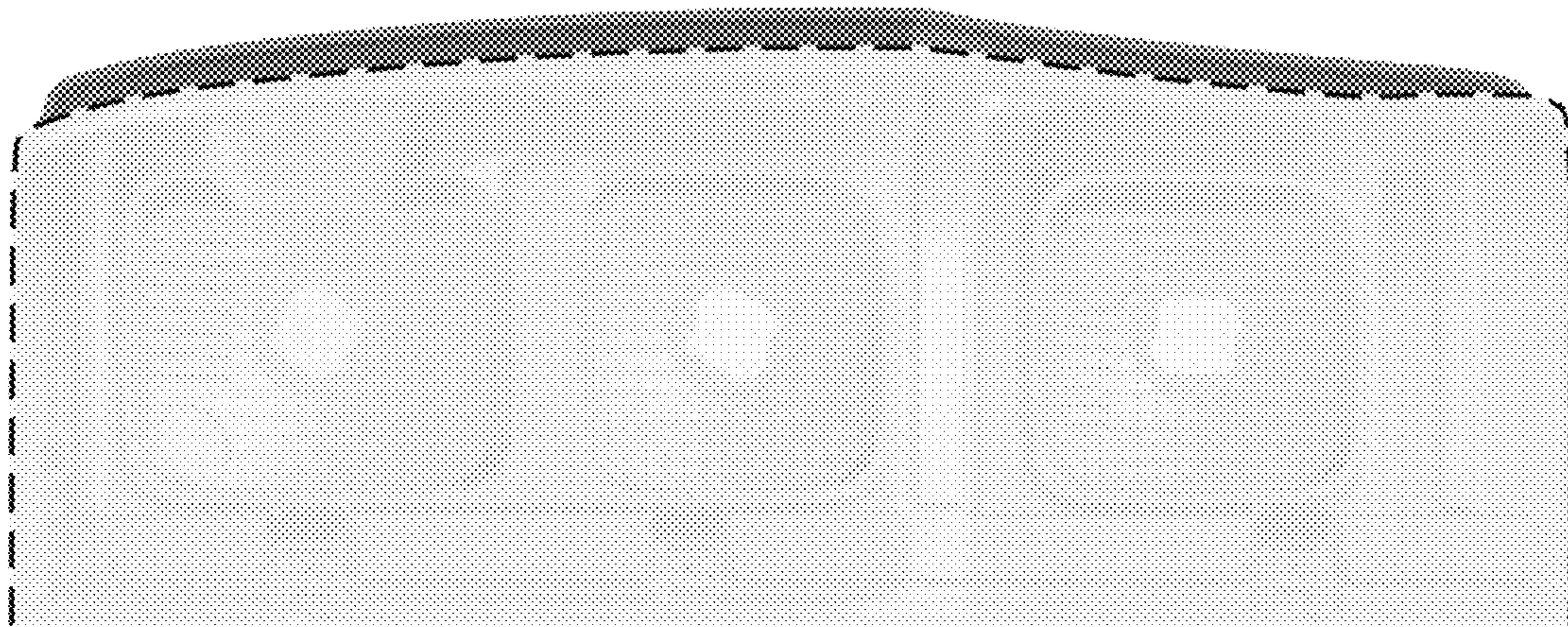
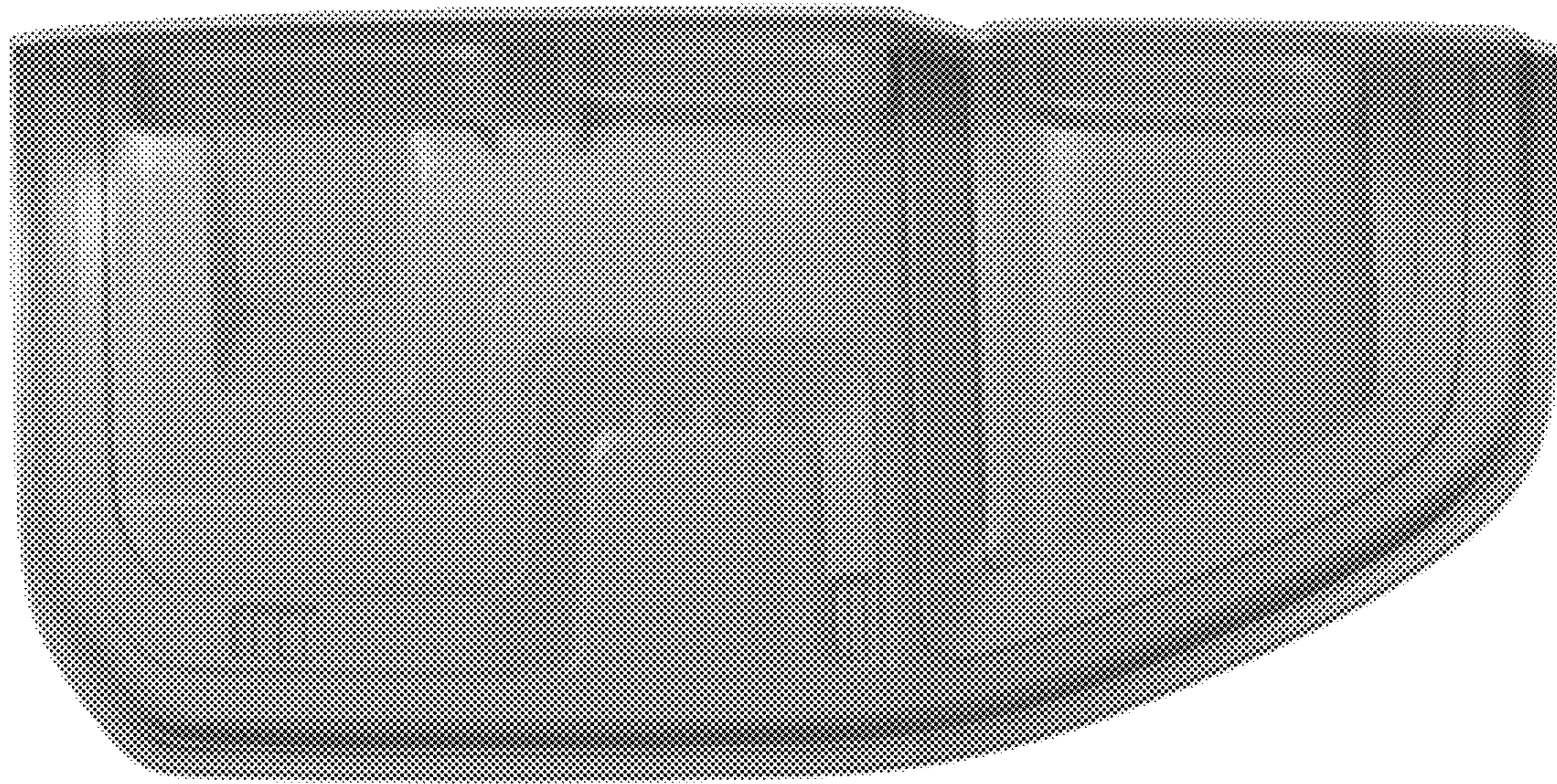

Fig. 11





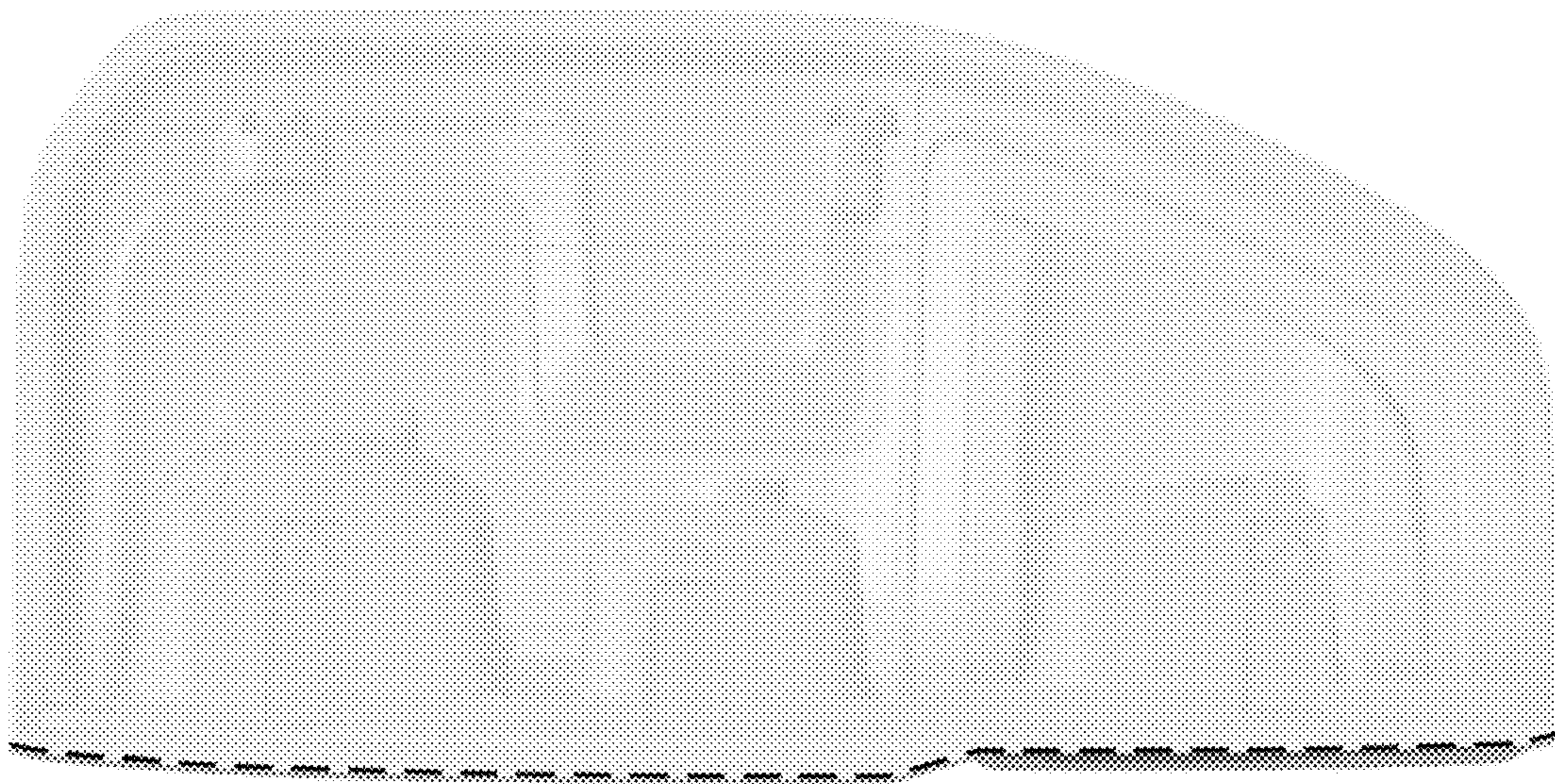

Fig. 12



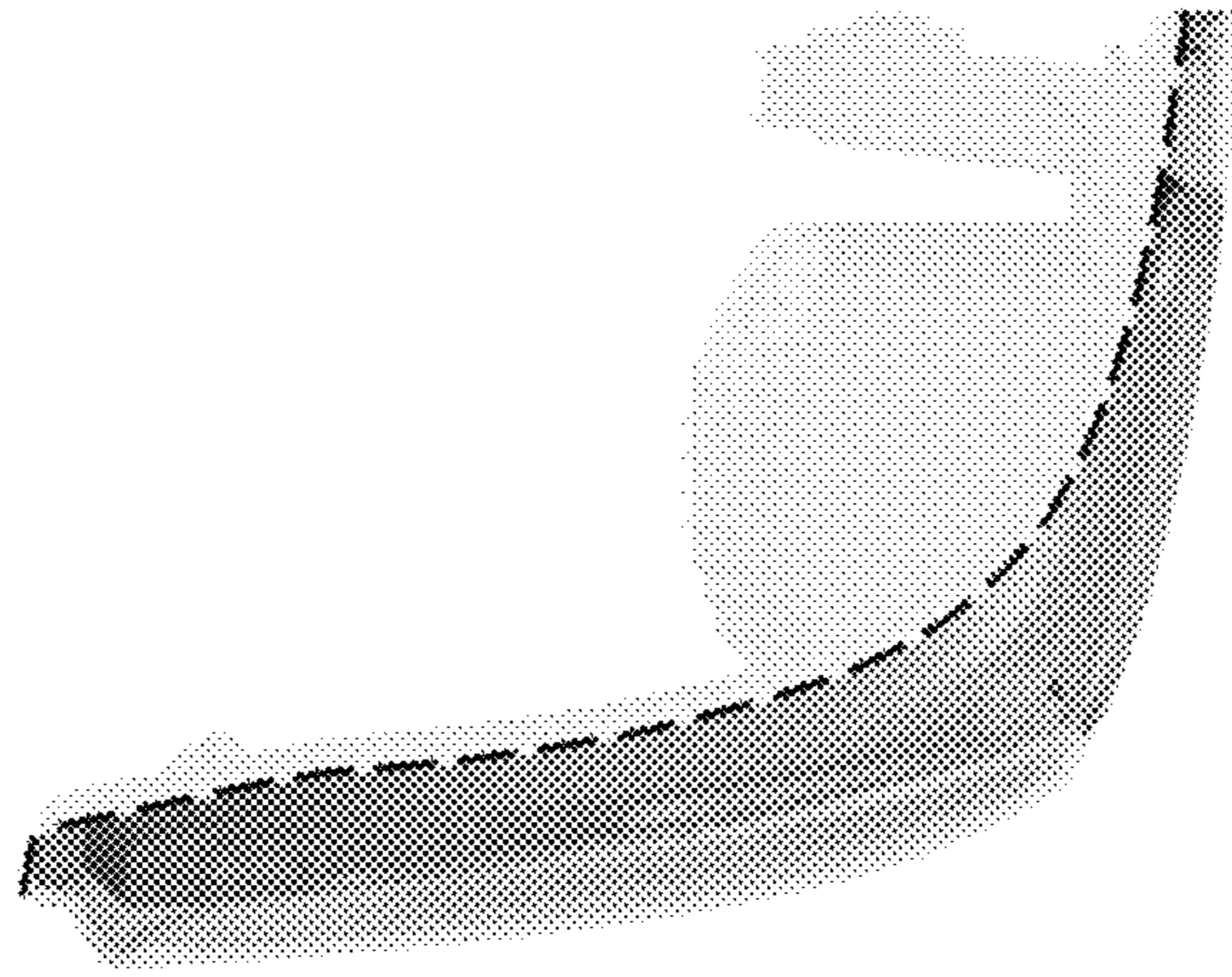

Fig. 13

Fig. 14

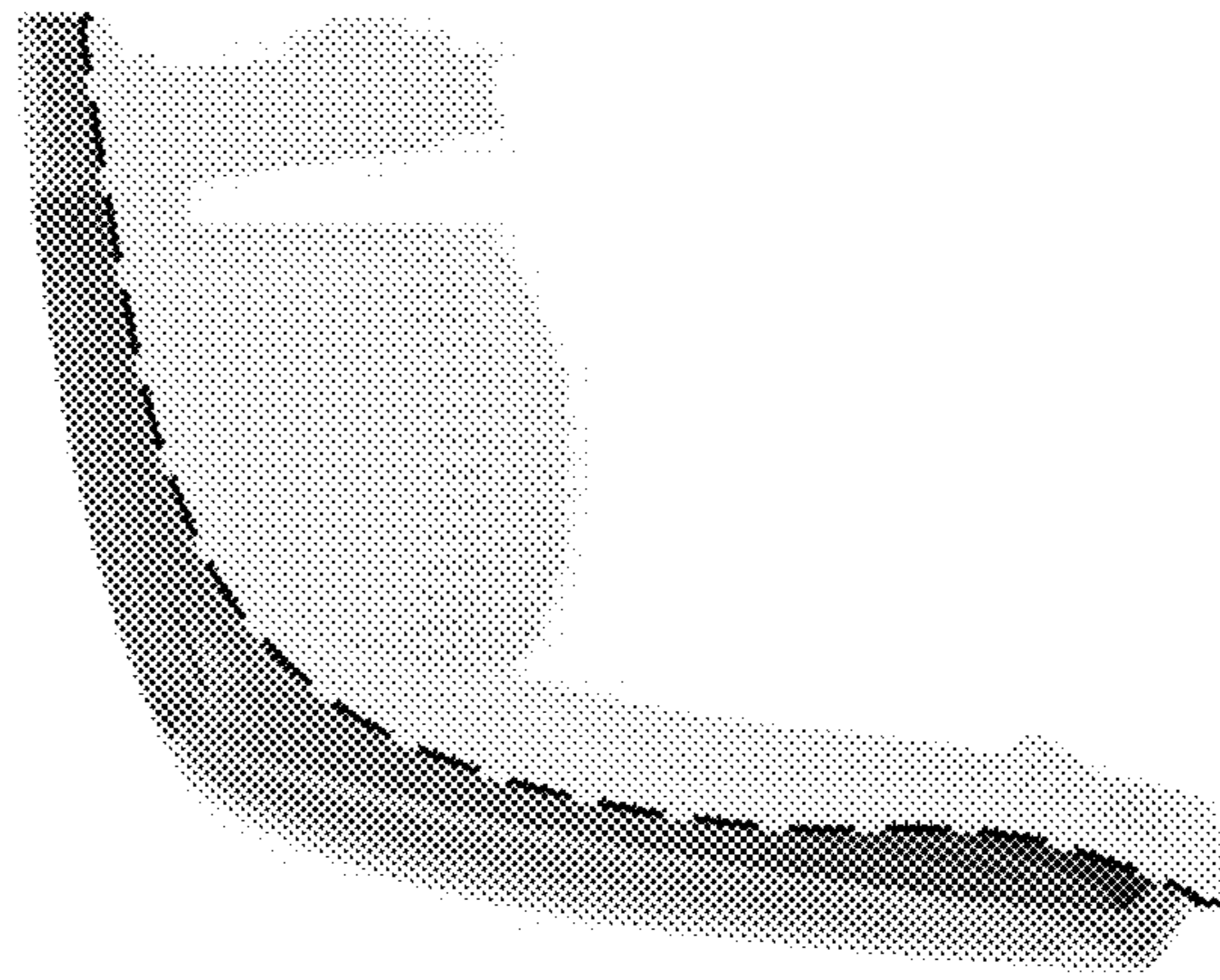
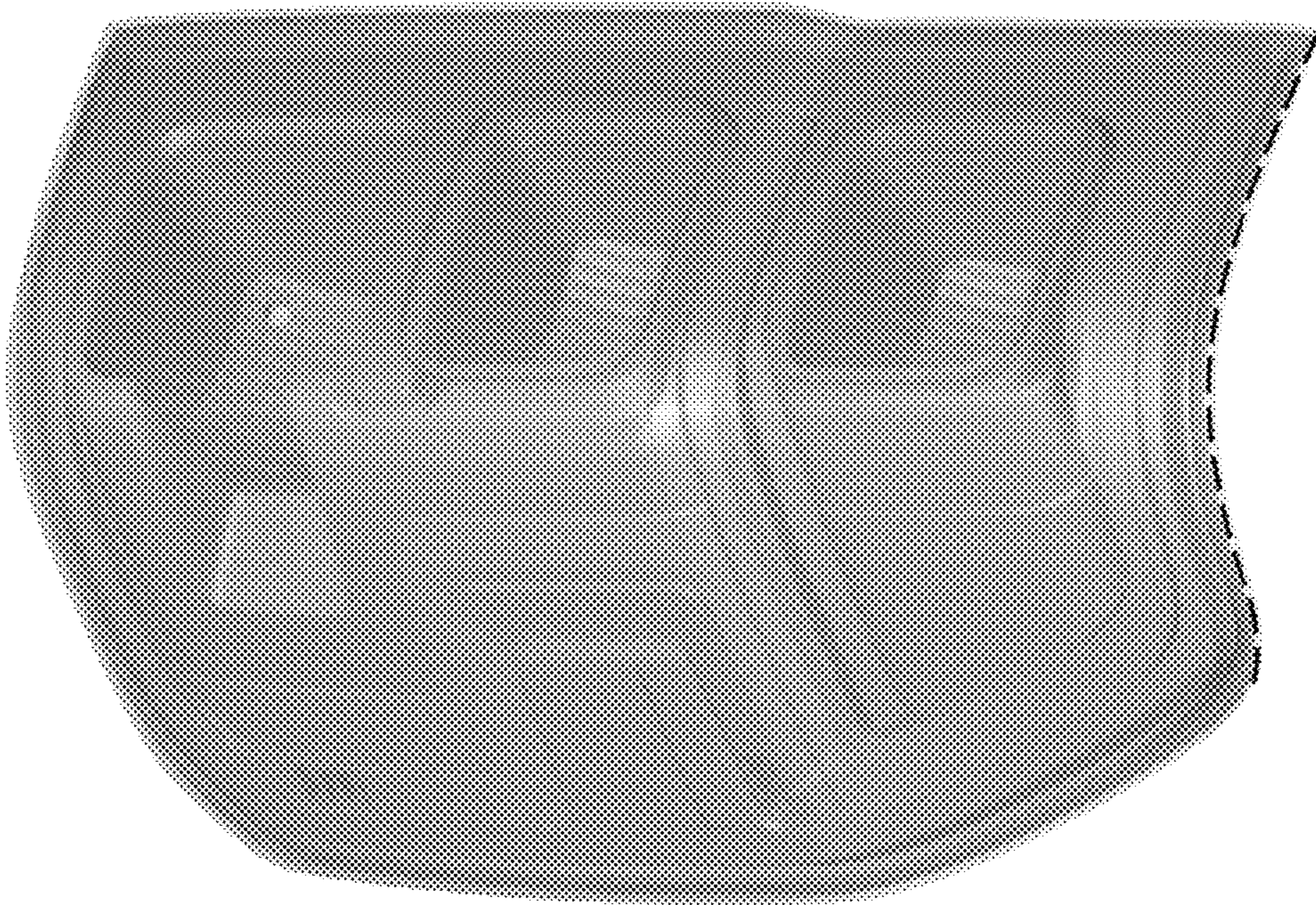

Fig. 15





Fig. 16



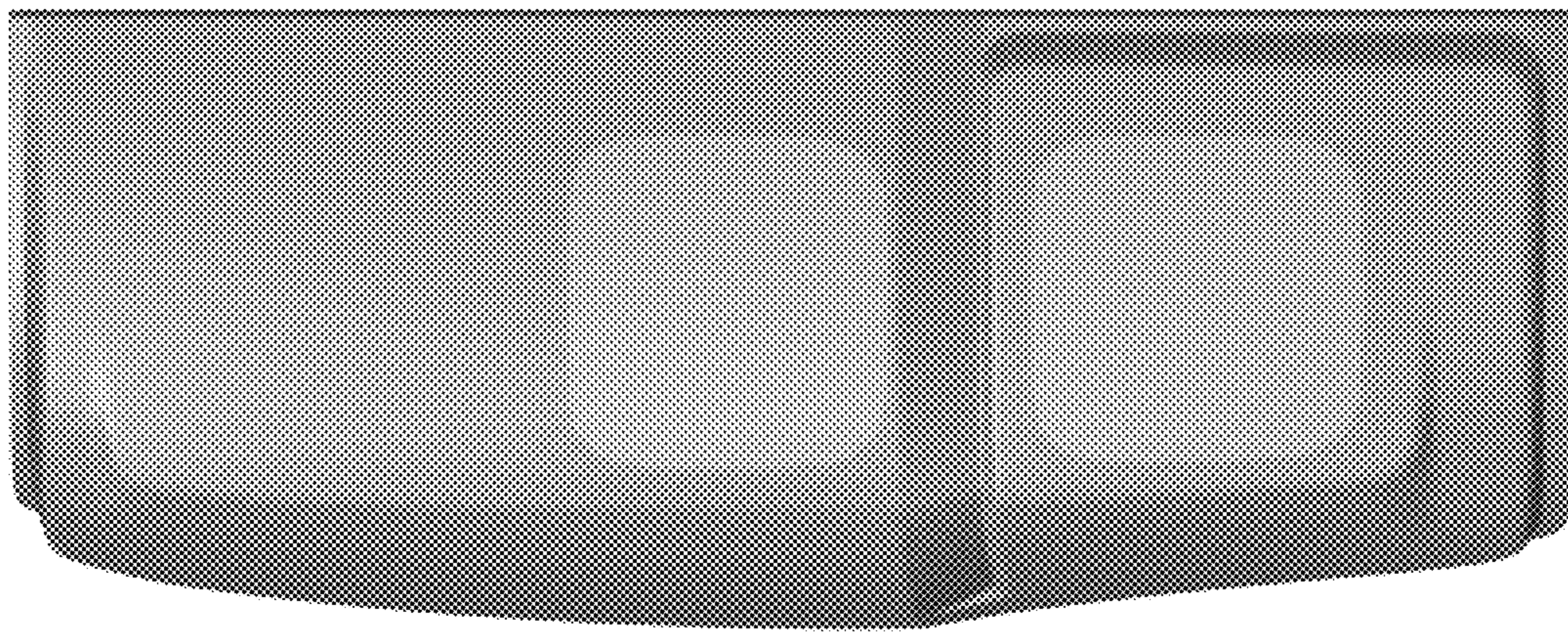
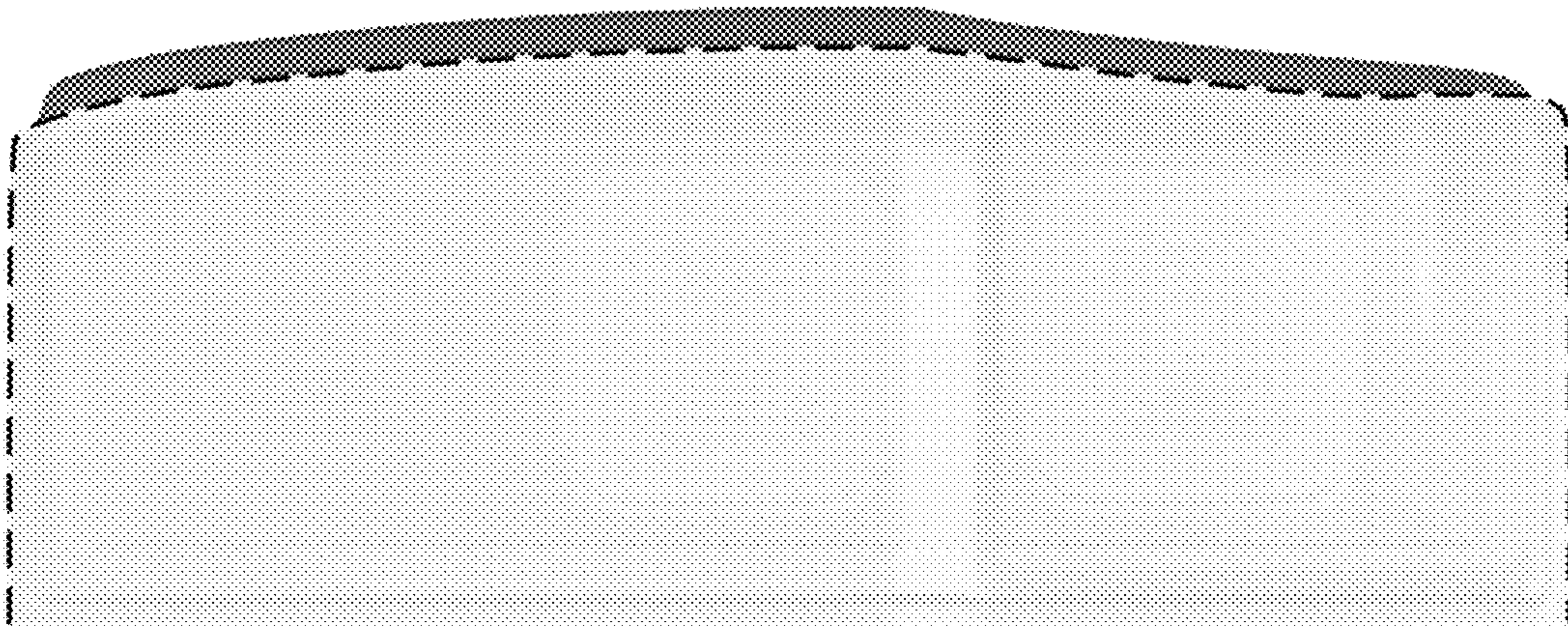

Fig. 17

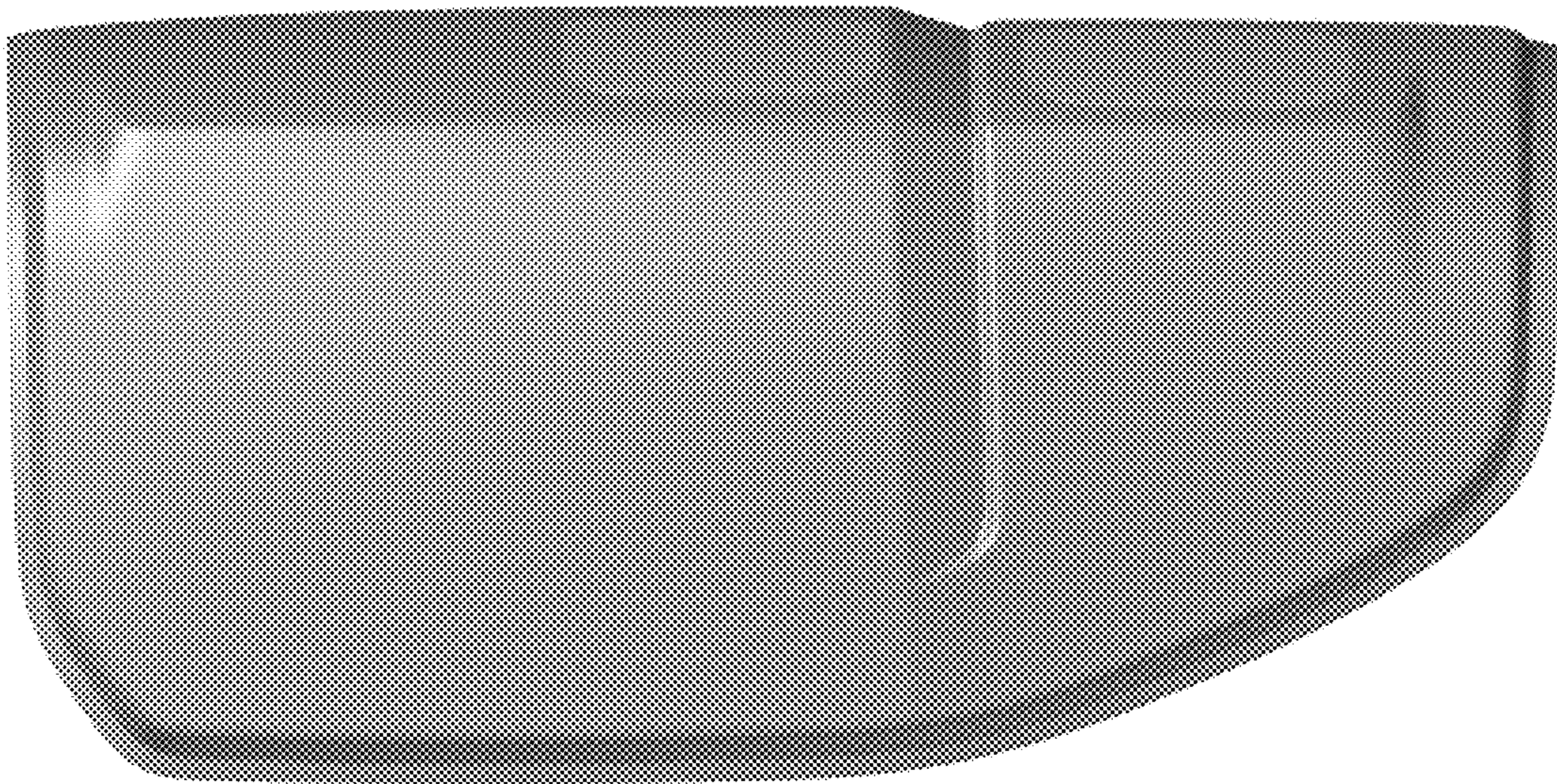

Fig. 18





*Fig. 19*



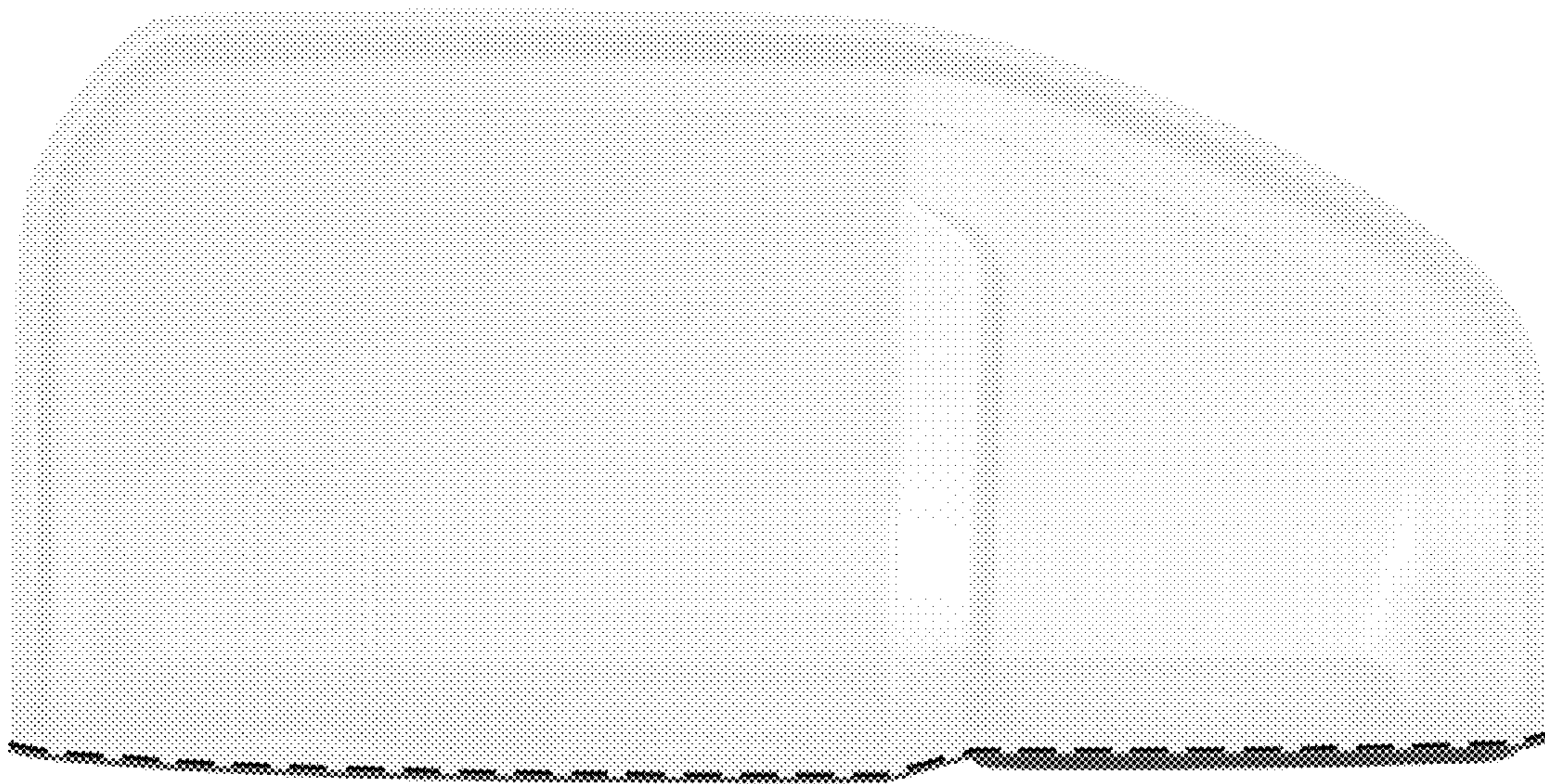

Fig. 20

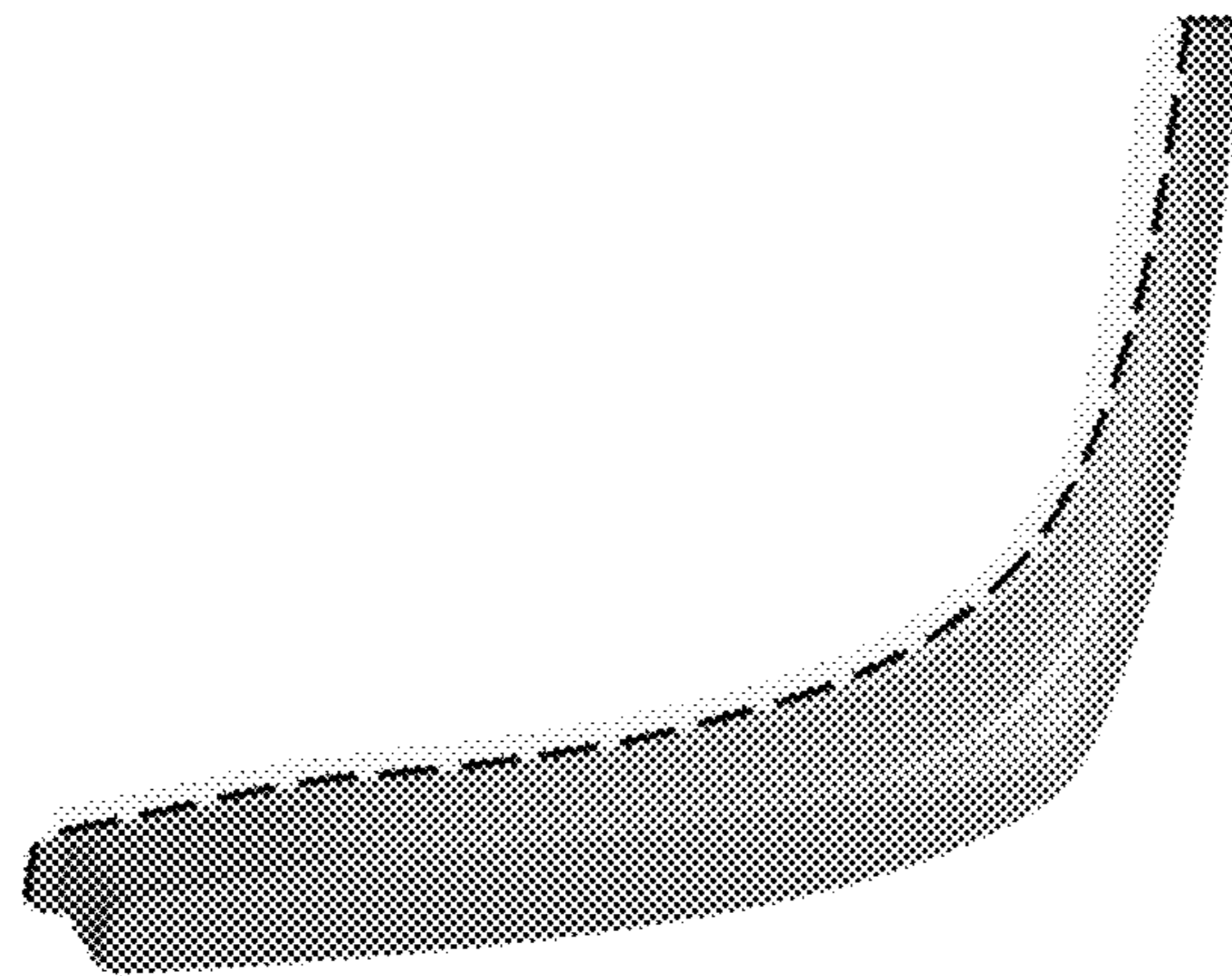

Fig. 21



Fig. 22

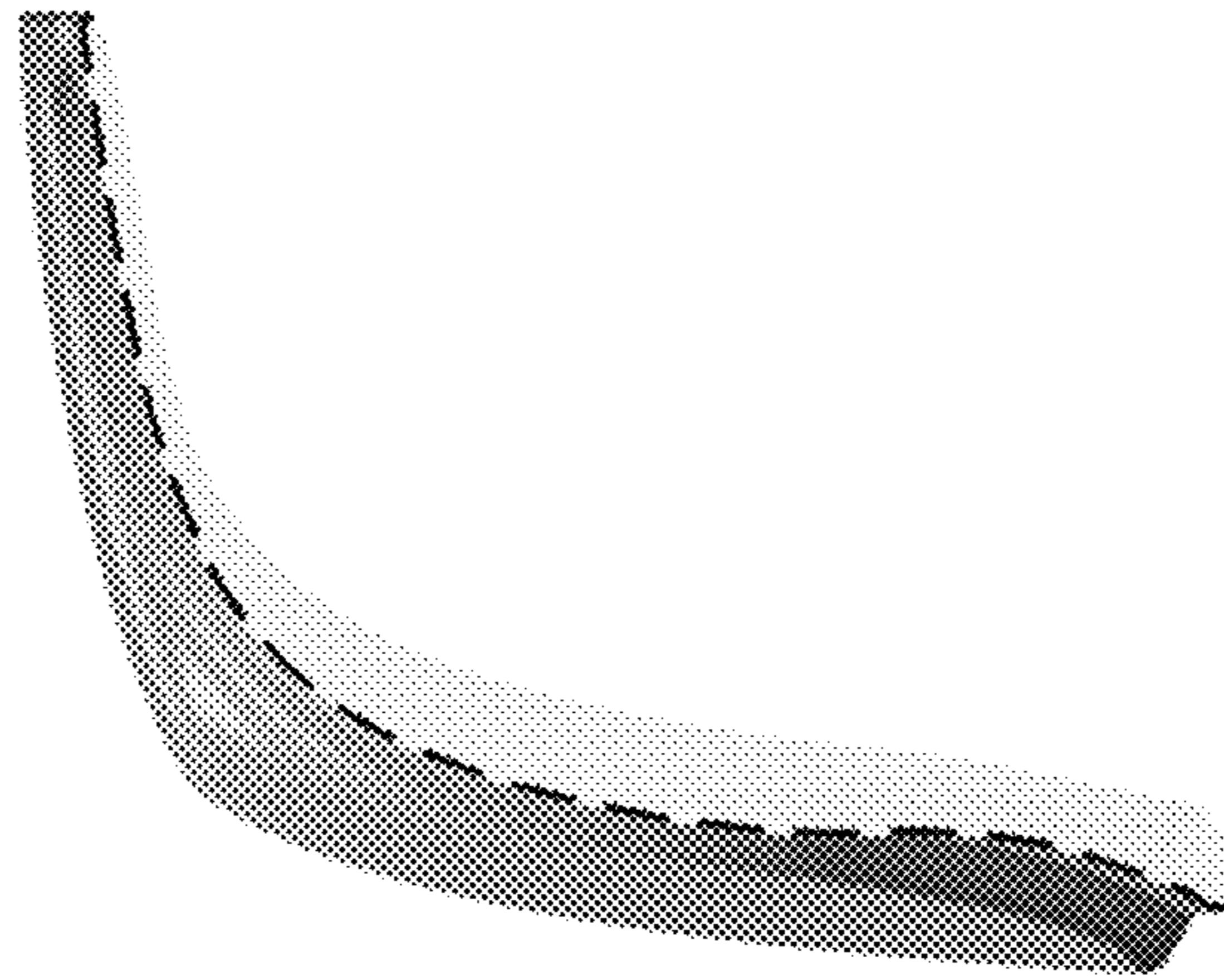

Fig. 23

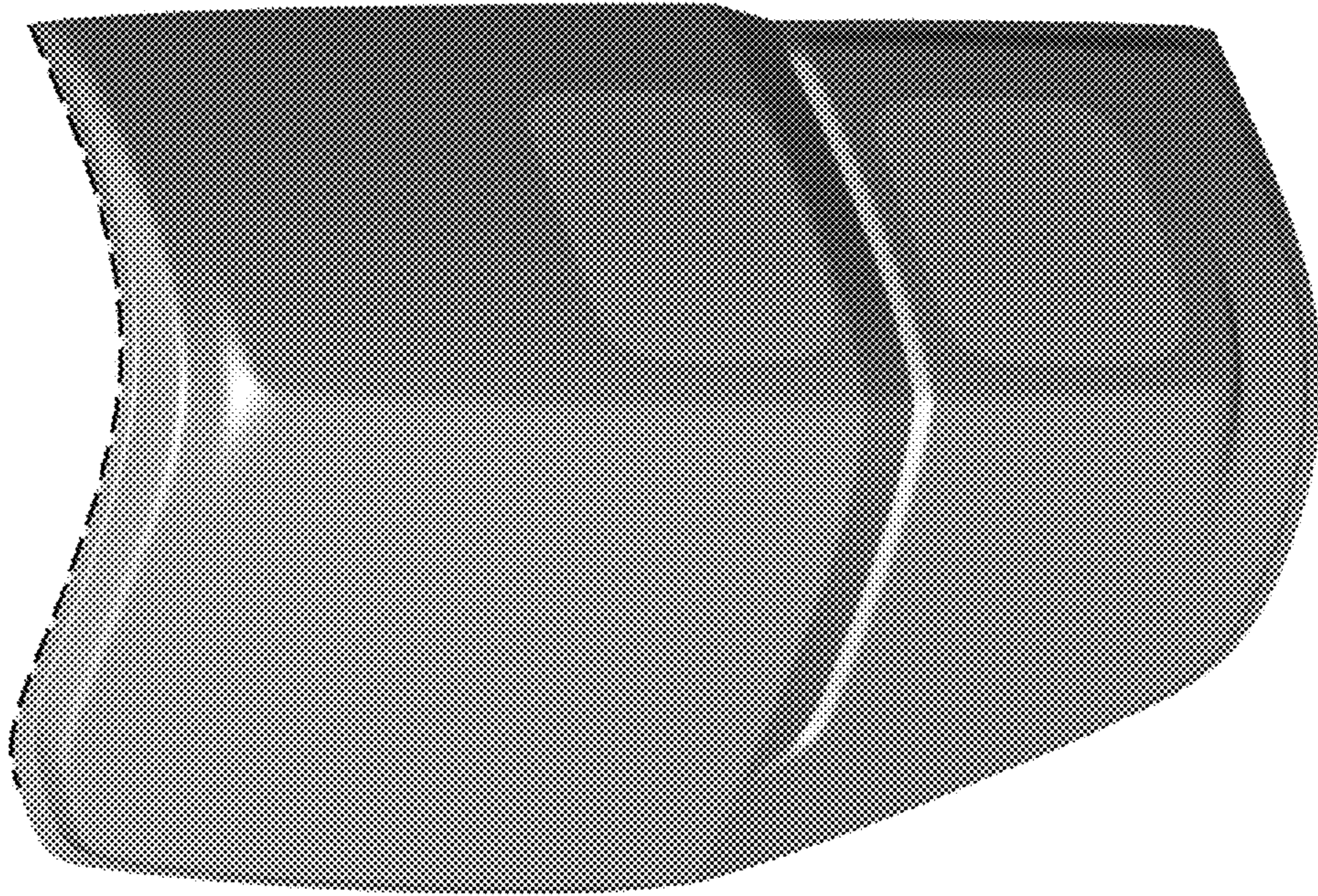
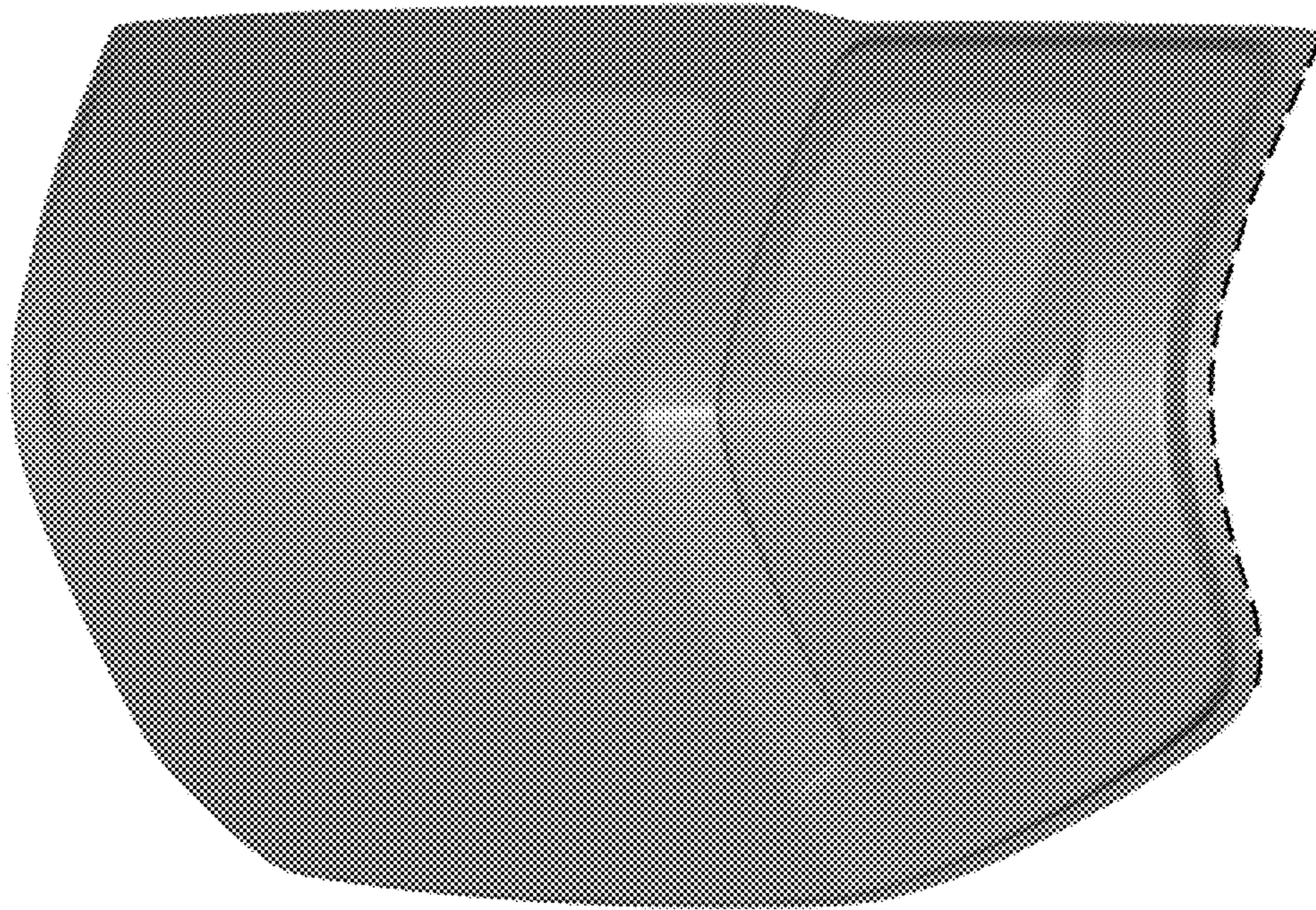



Fig. 24





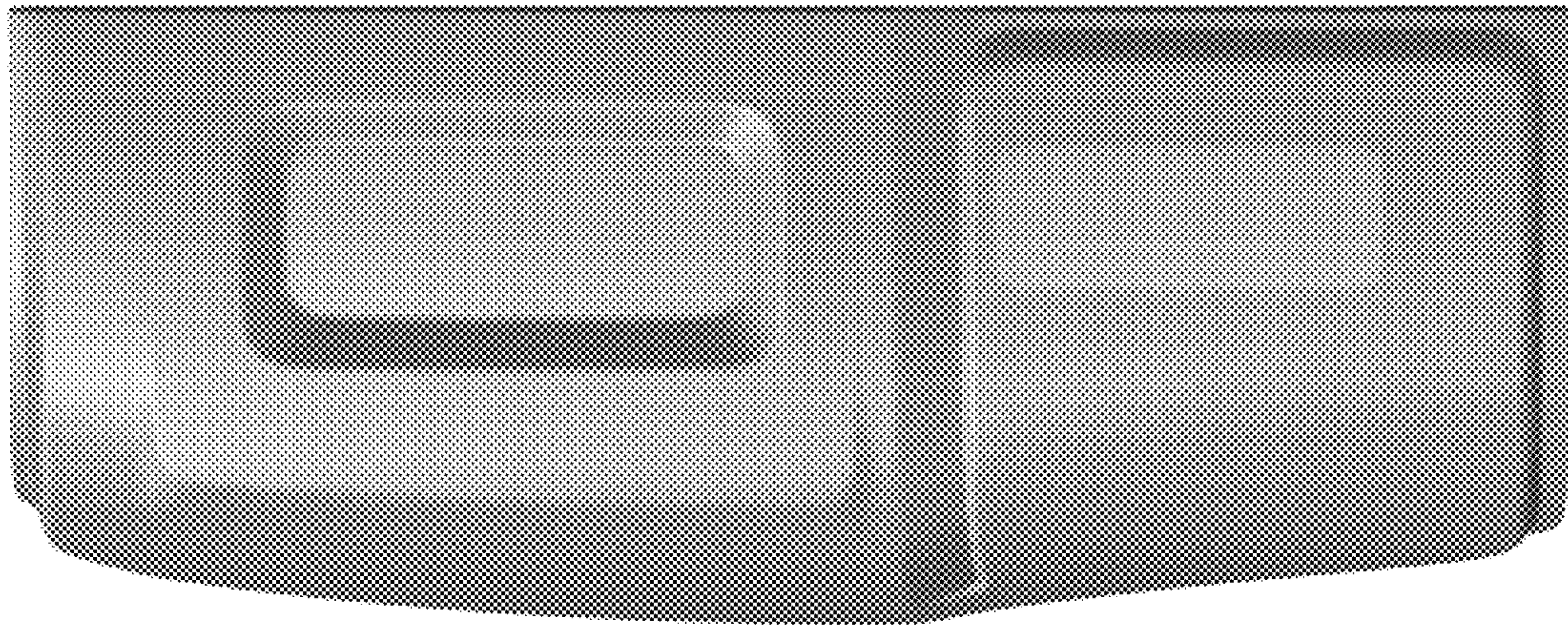

Fig. 25

Fig. 26

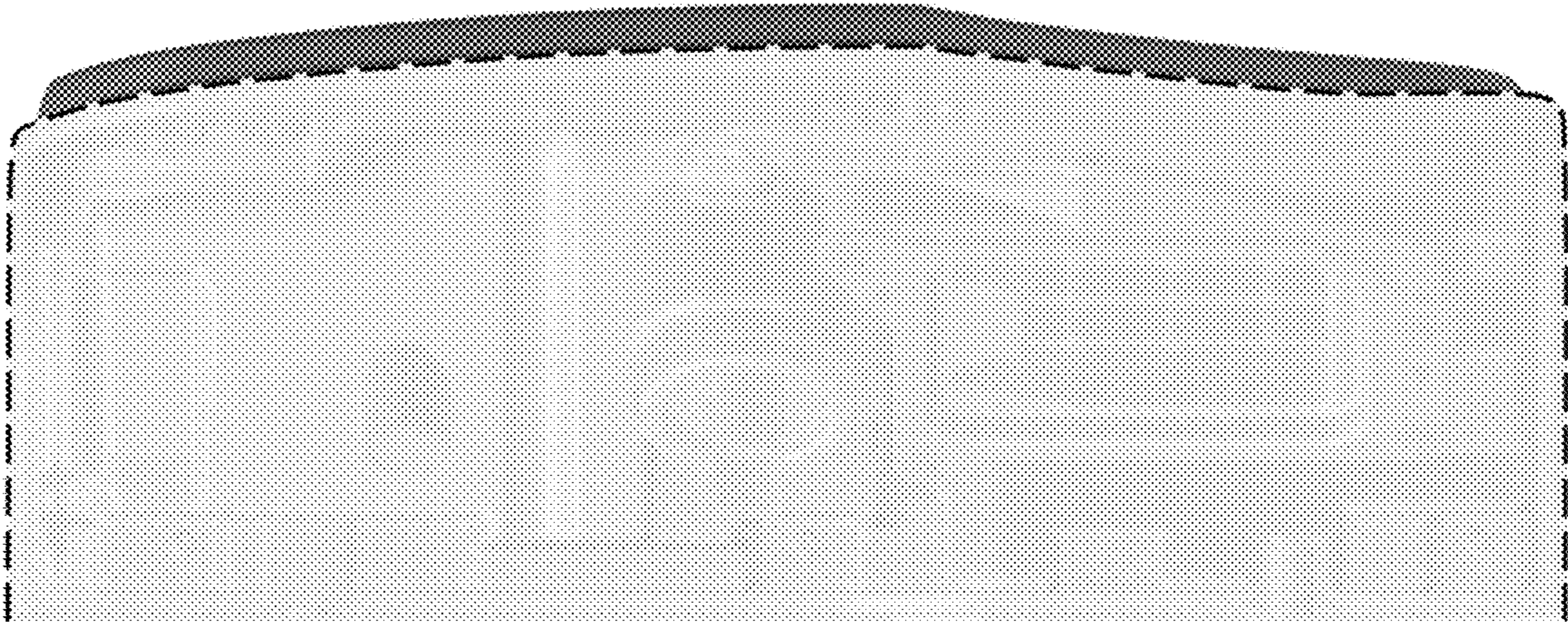
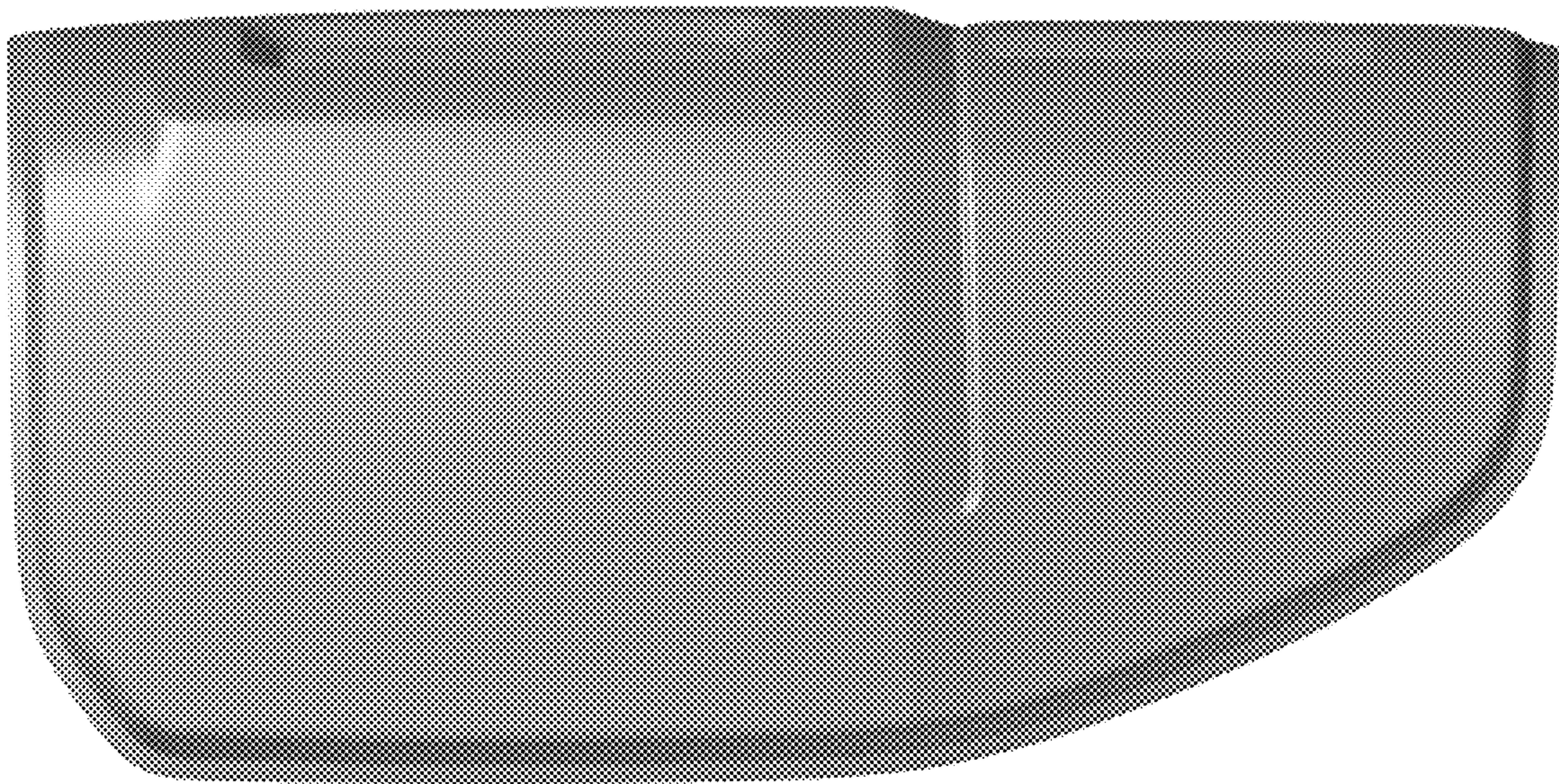



Fig. 27





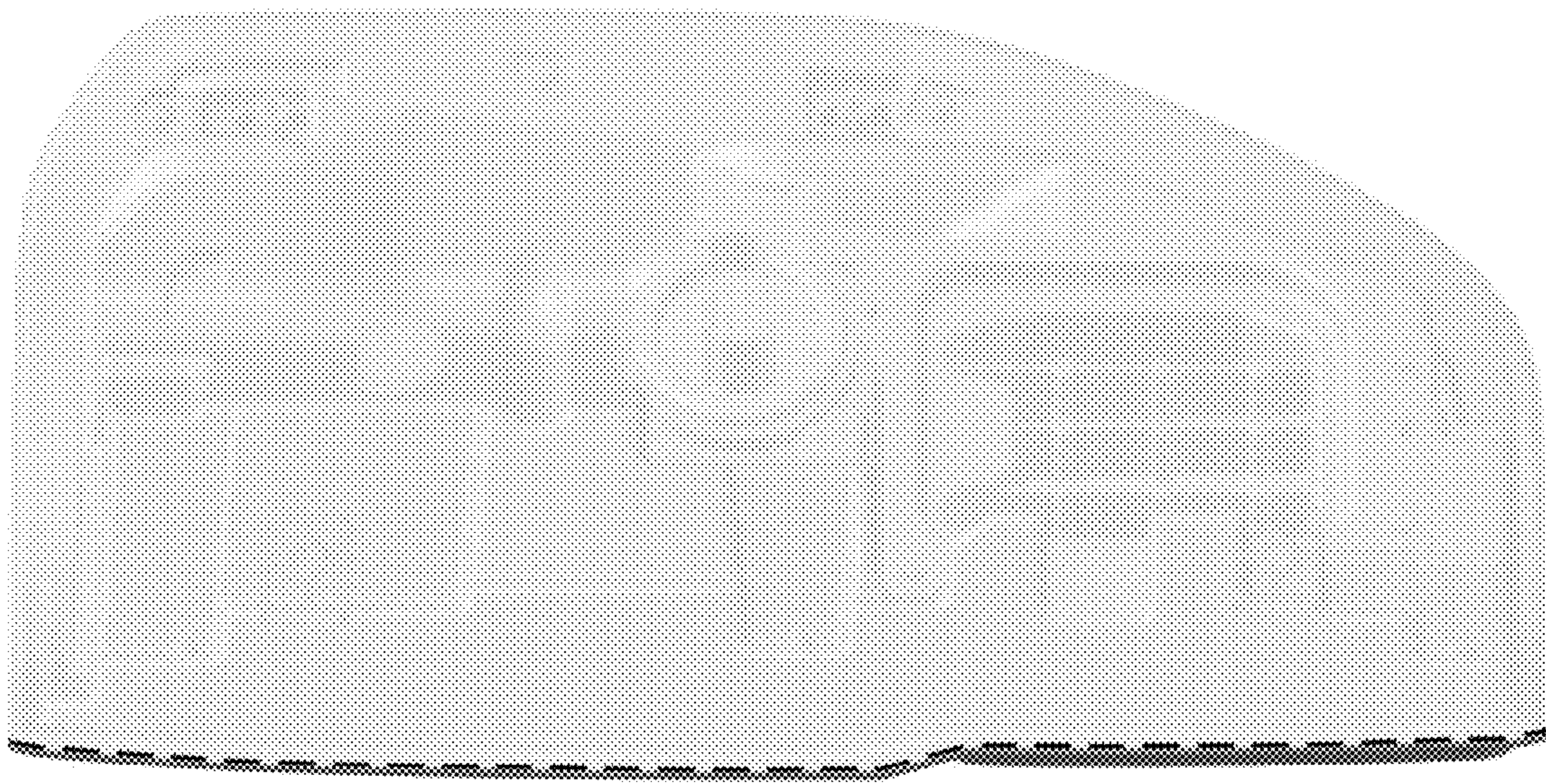

Fig. 28

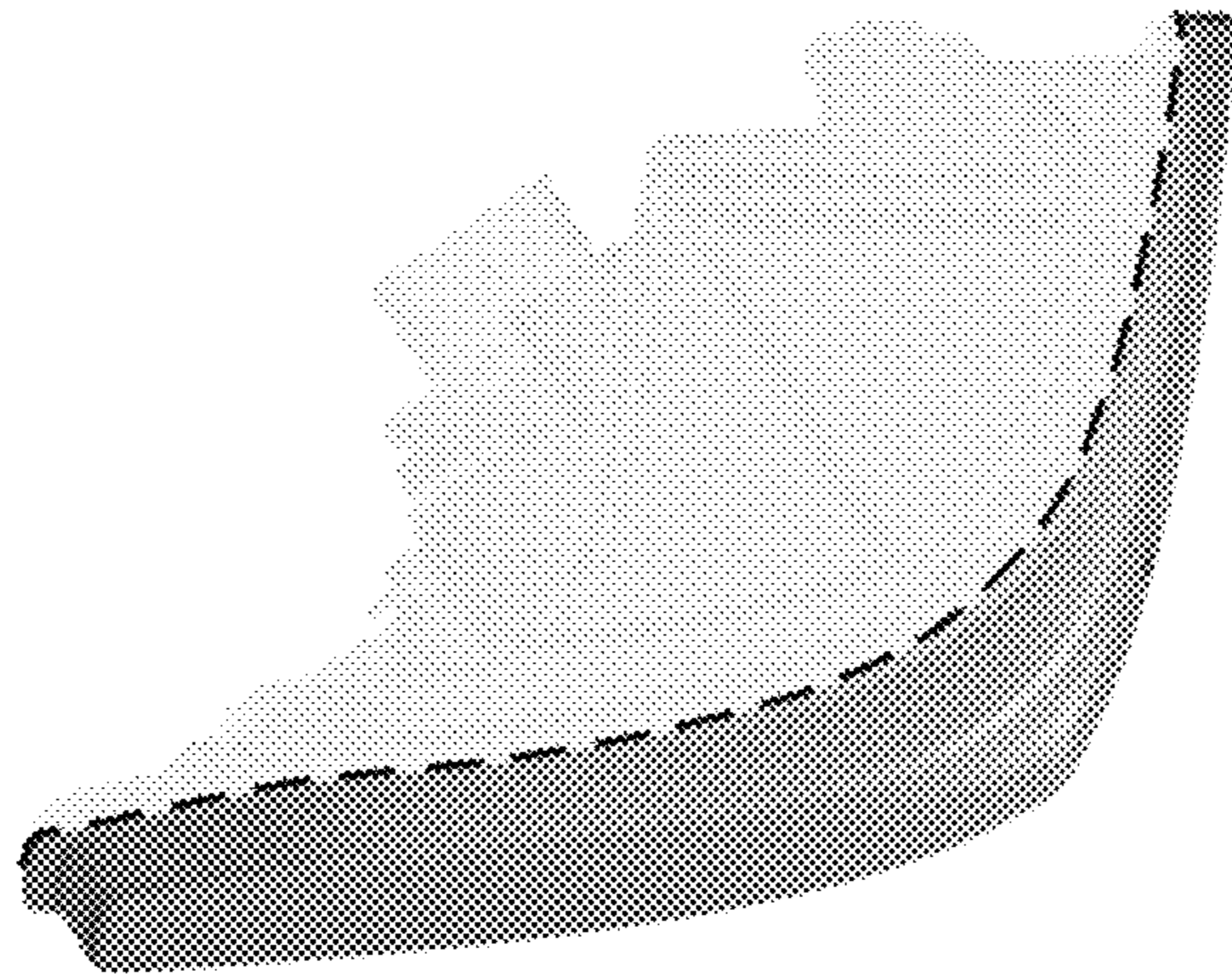

Fig. 29



Fig. 30

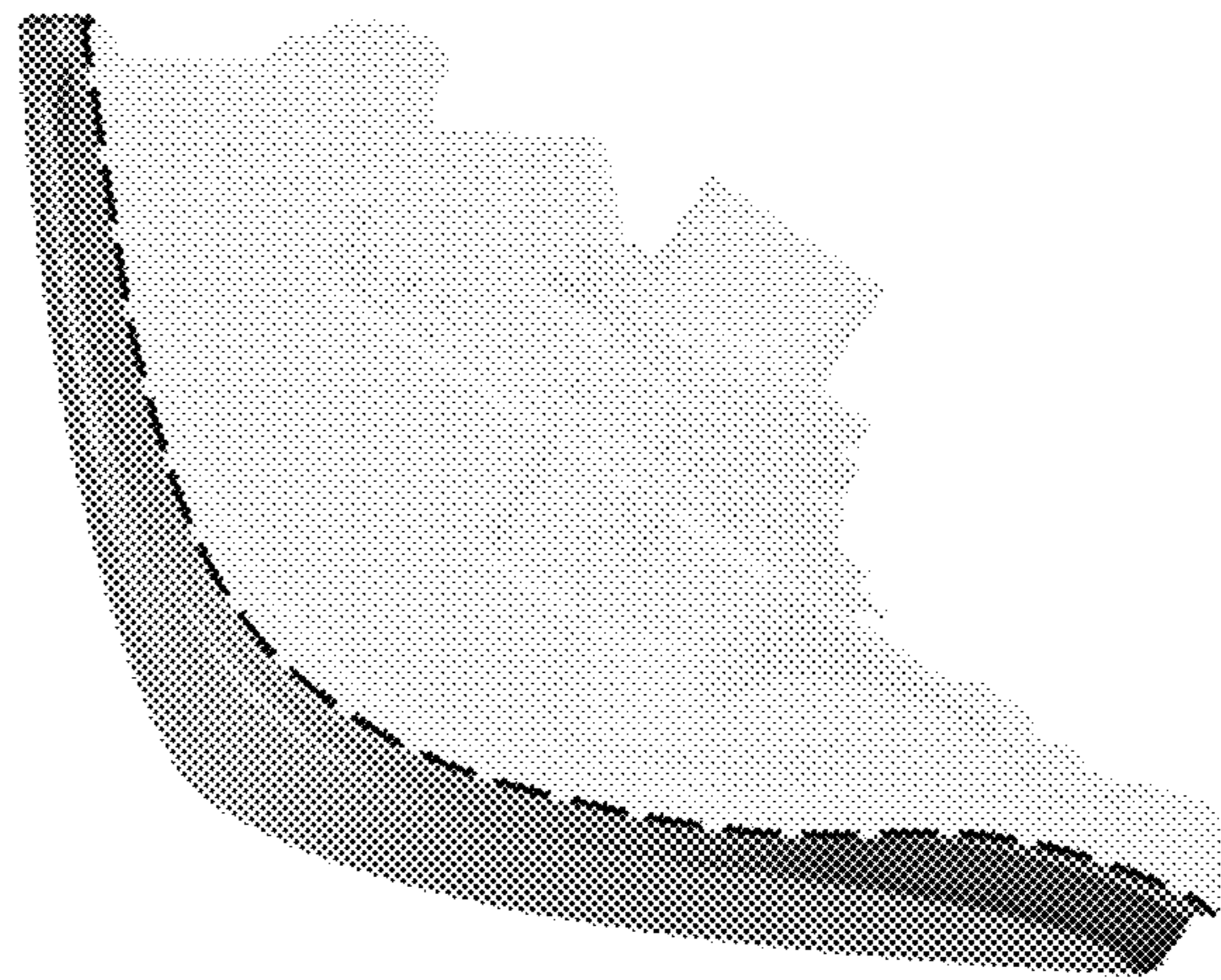

Fig. 31

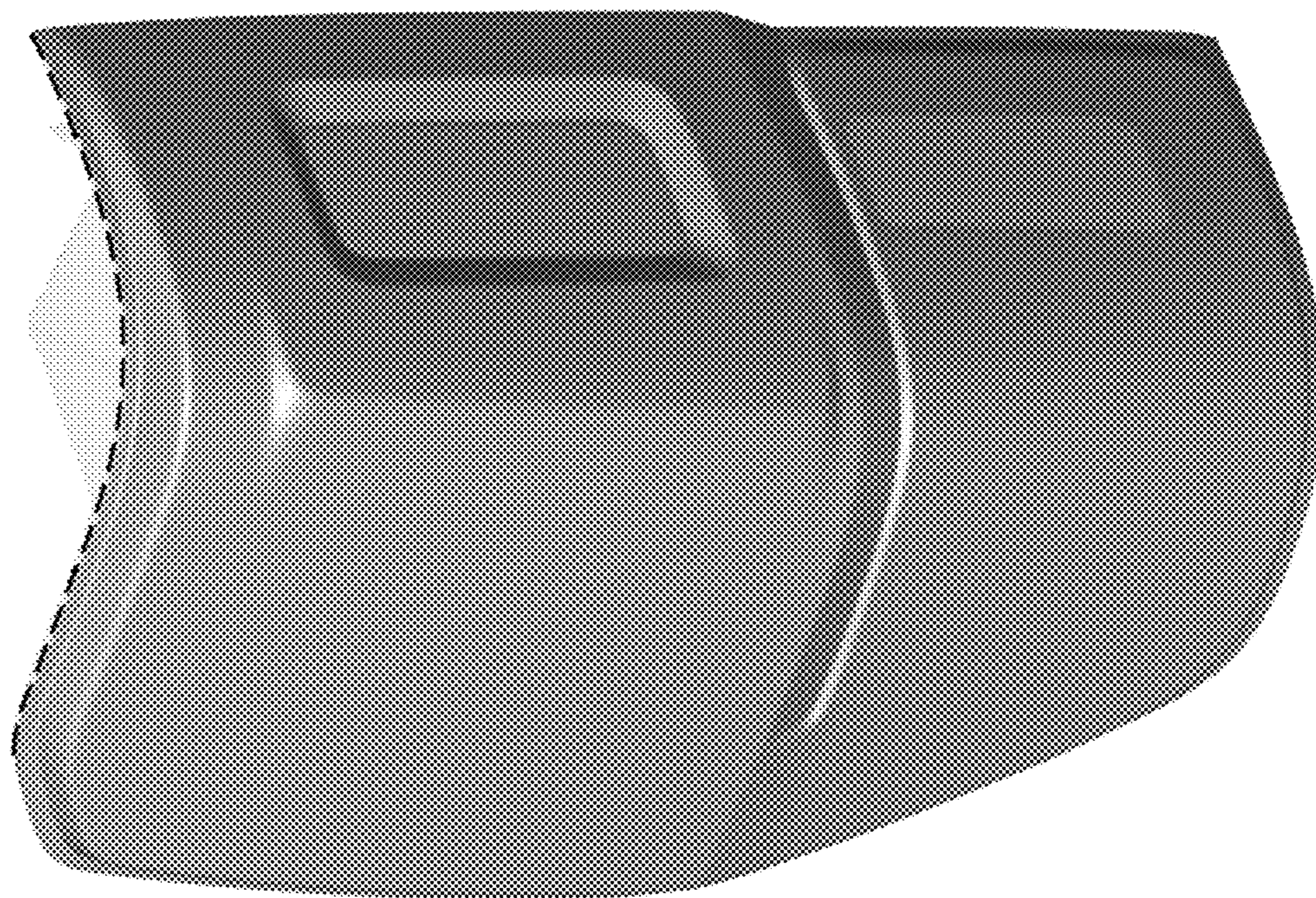
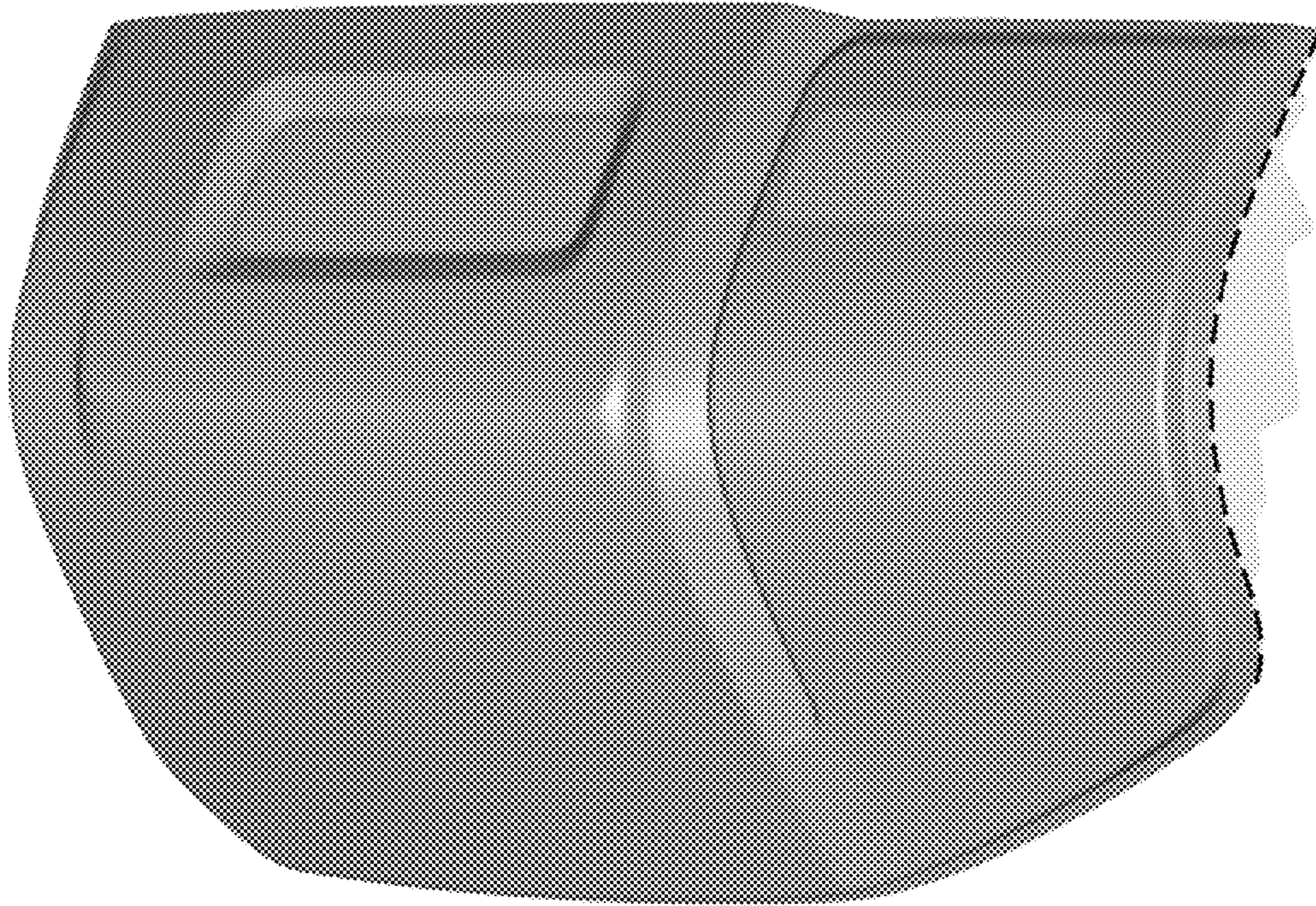



Fig. 32



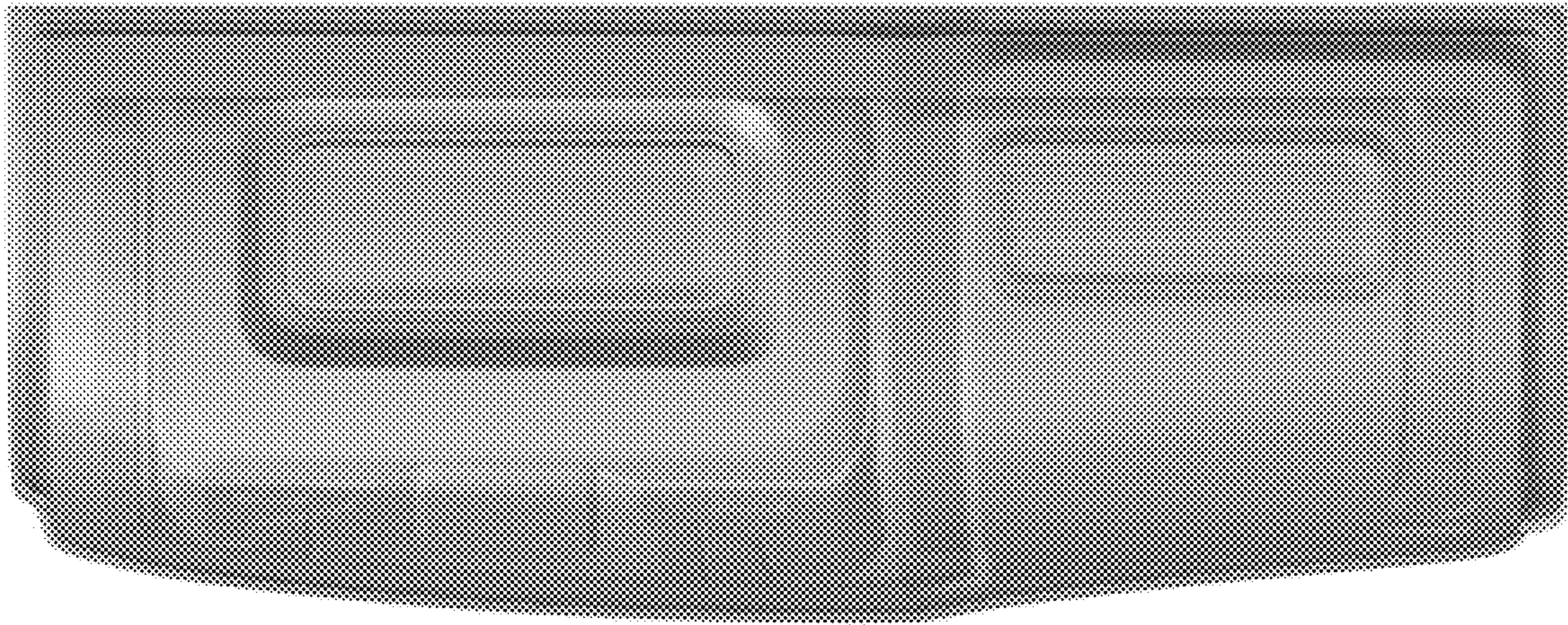

Fig. 33



Fig. 34

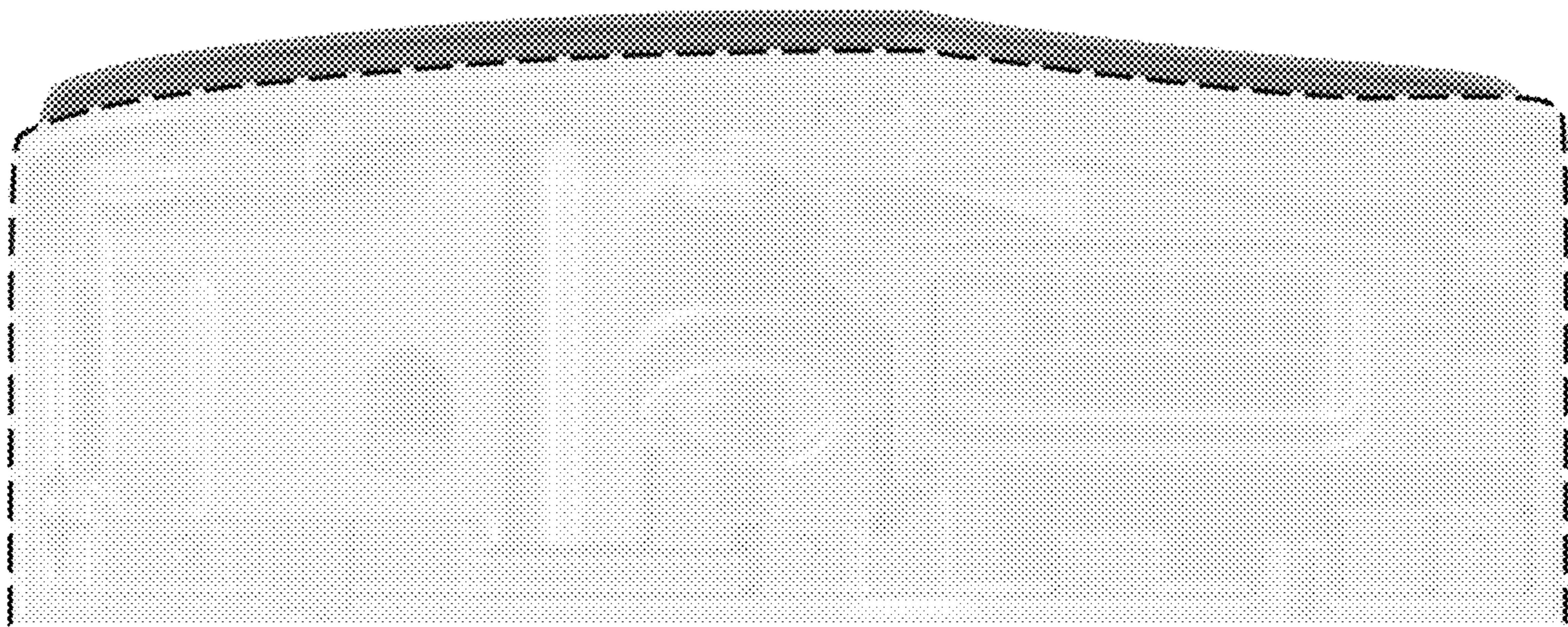
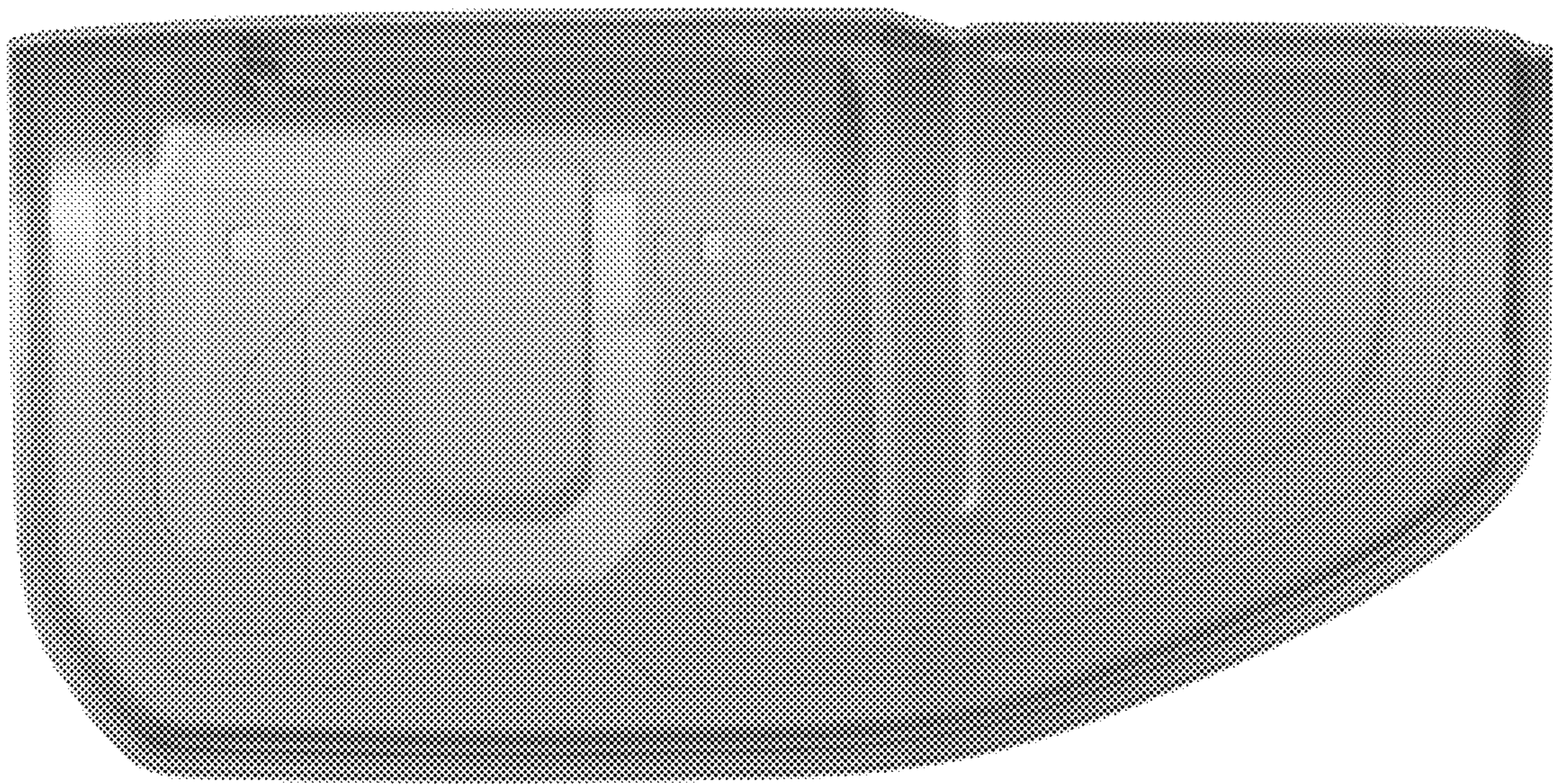



Fig. 35



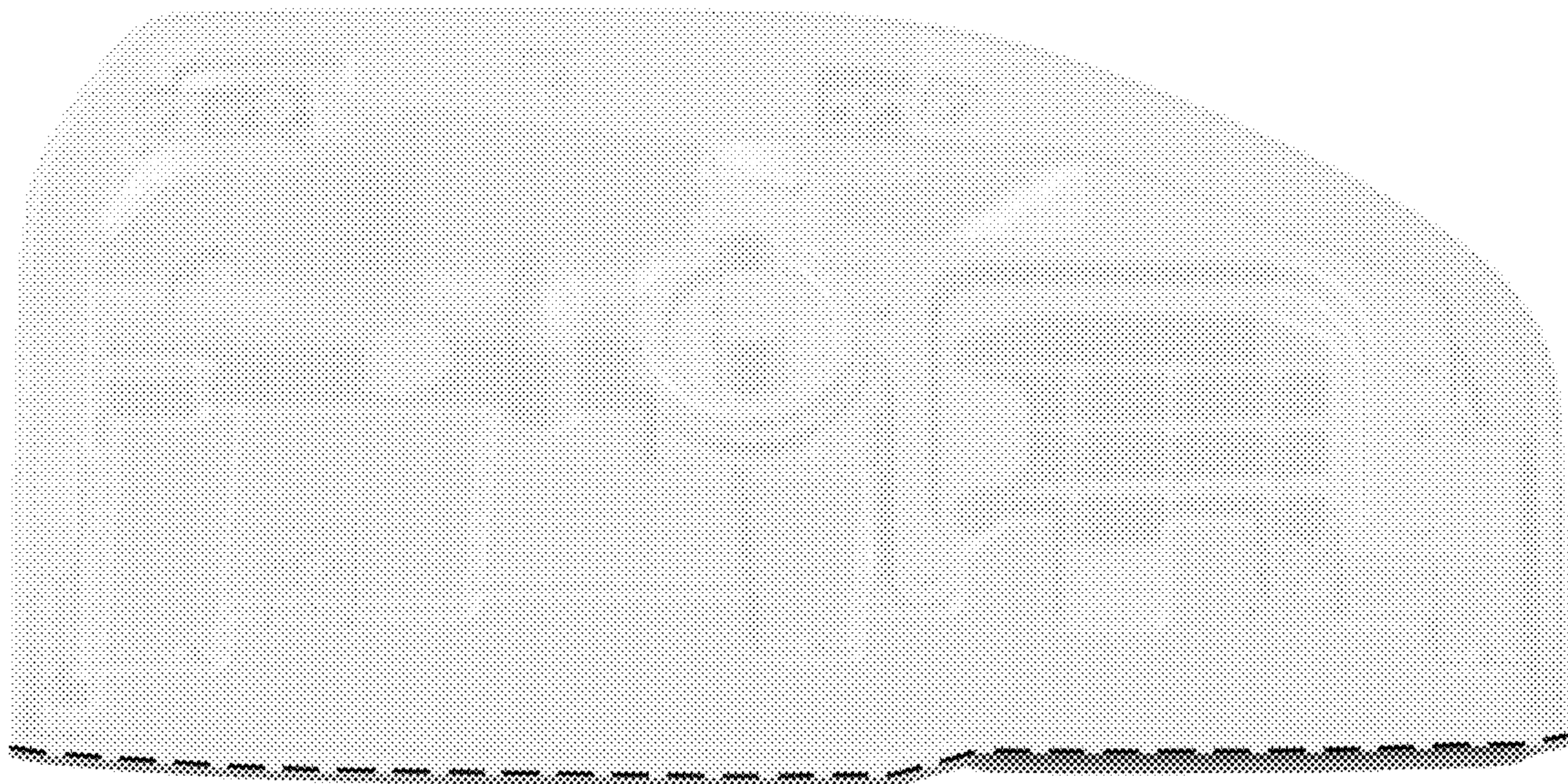

Fig. 36



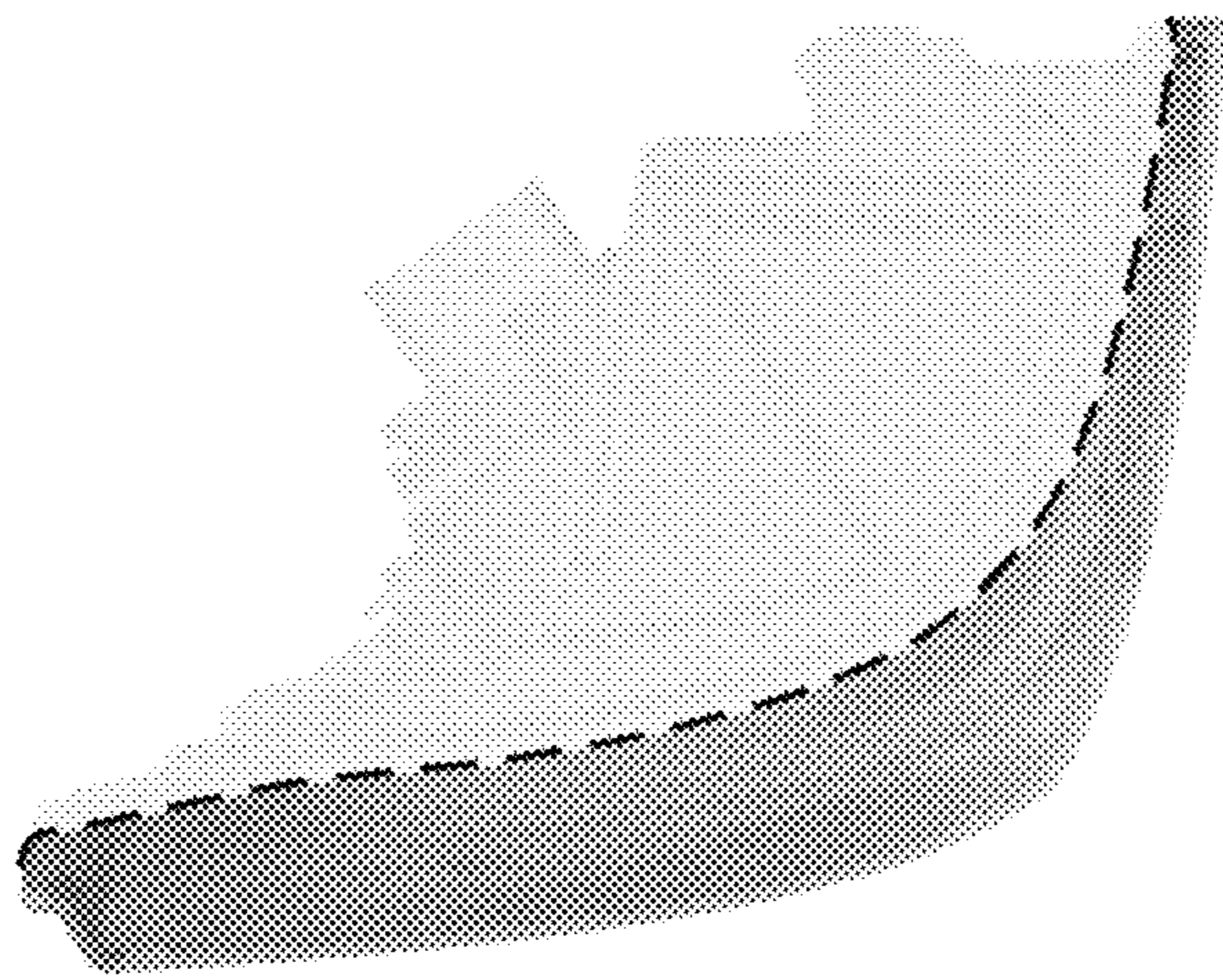

Fig. 37



Fig. 38

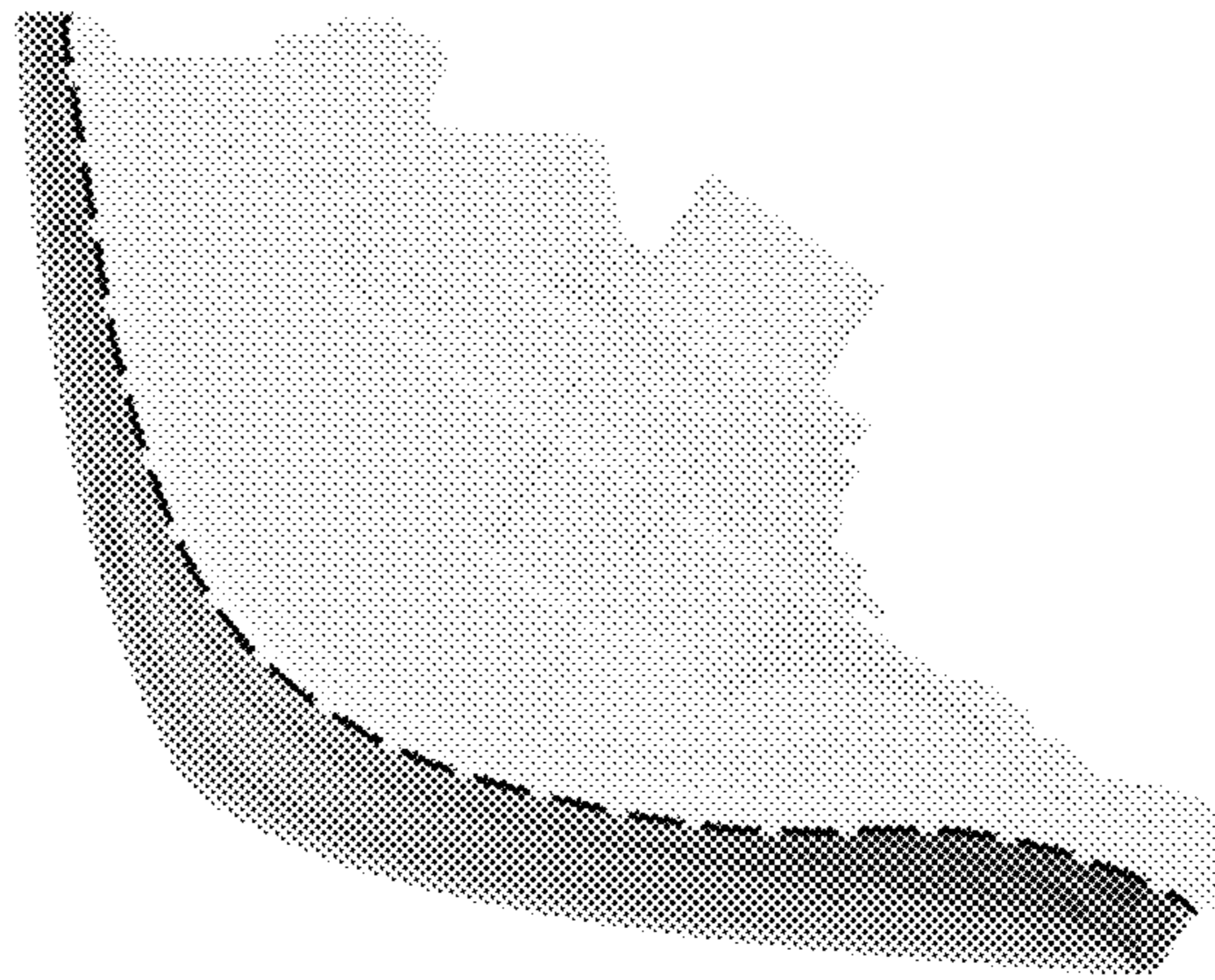

Fig. 39

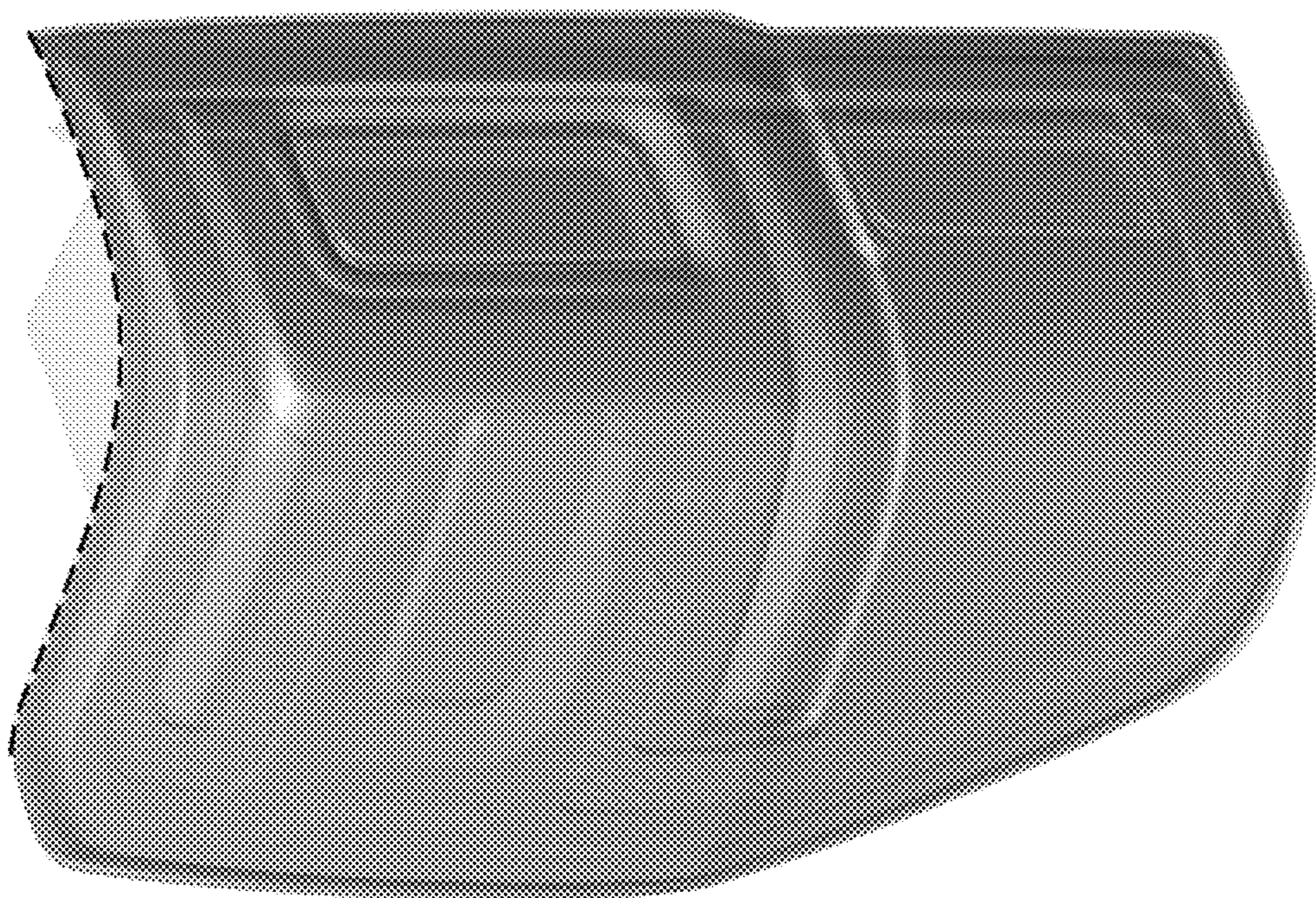
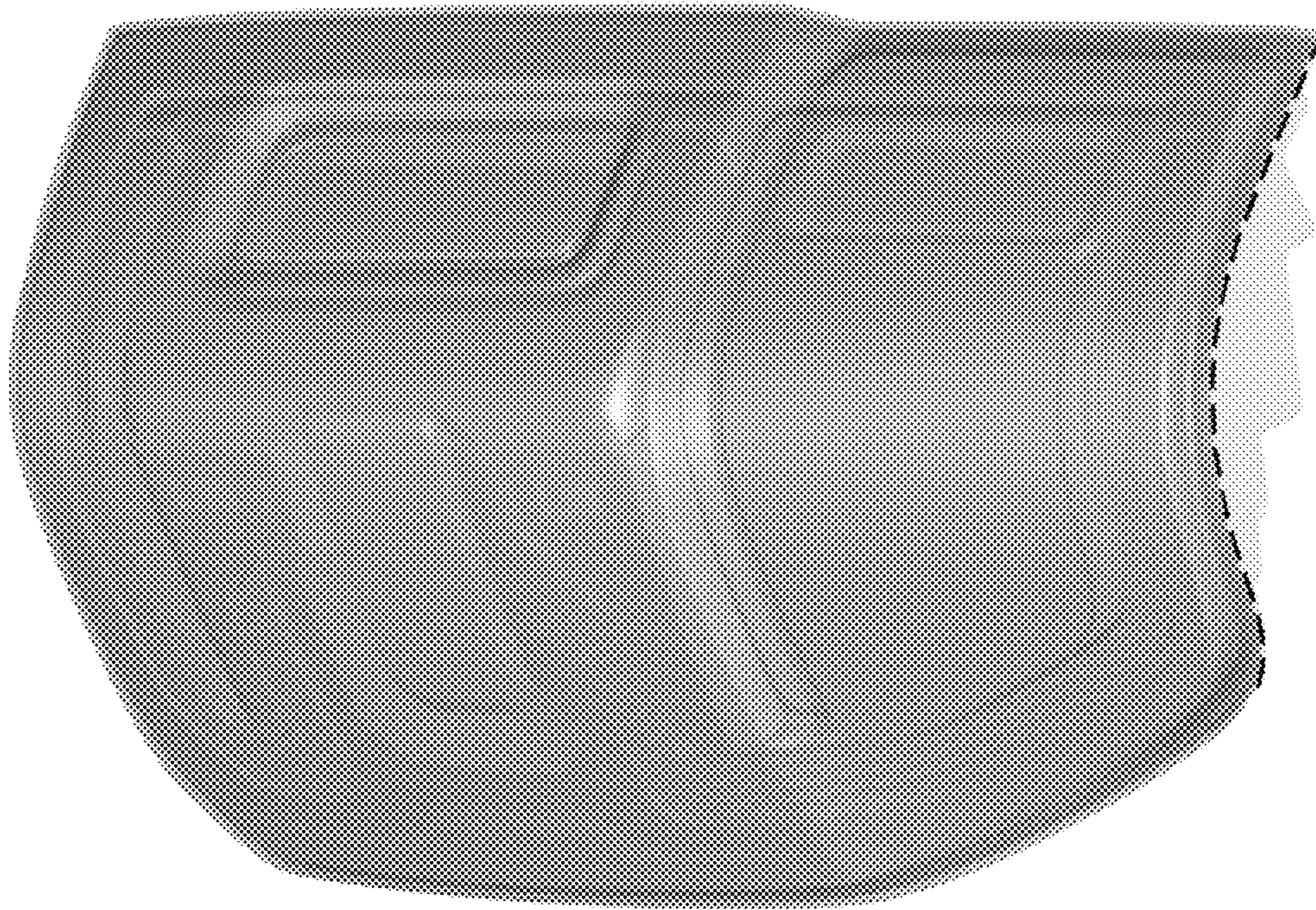
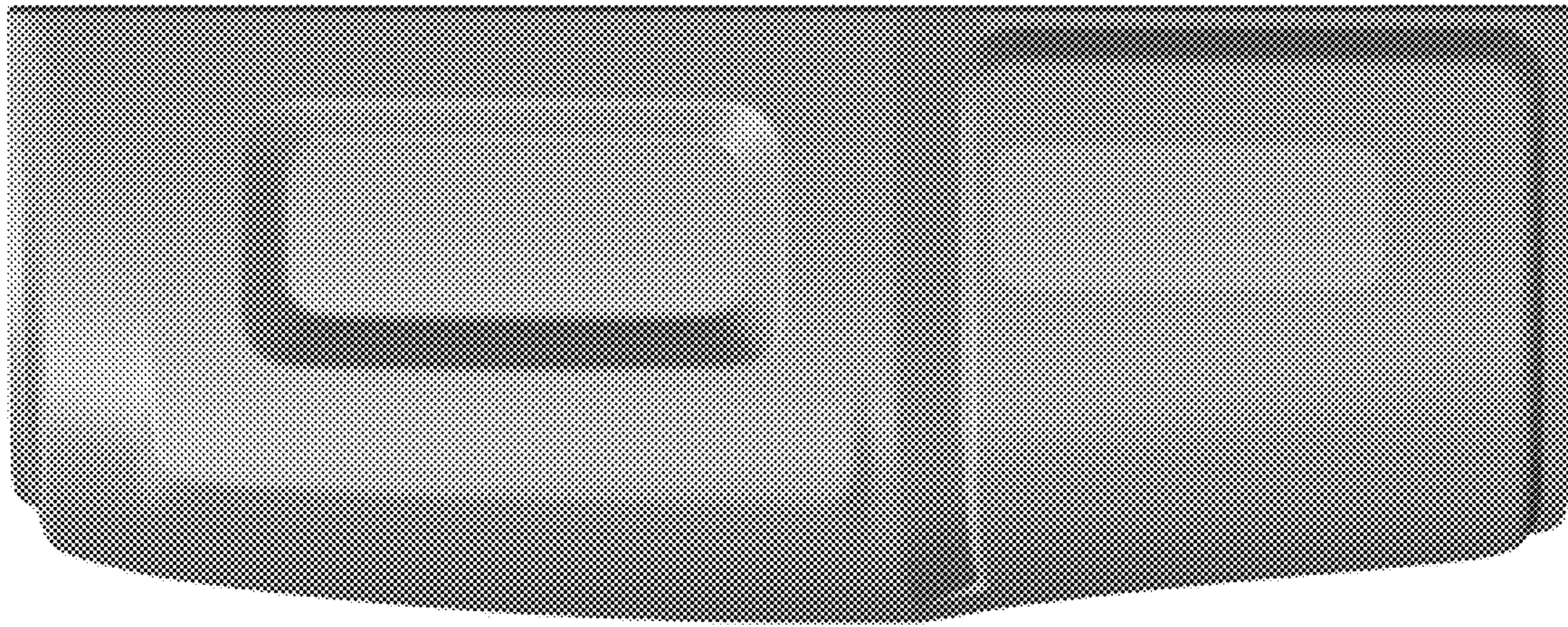



Fig. 40







*Fig. 41*

Fig. 42

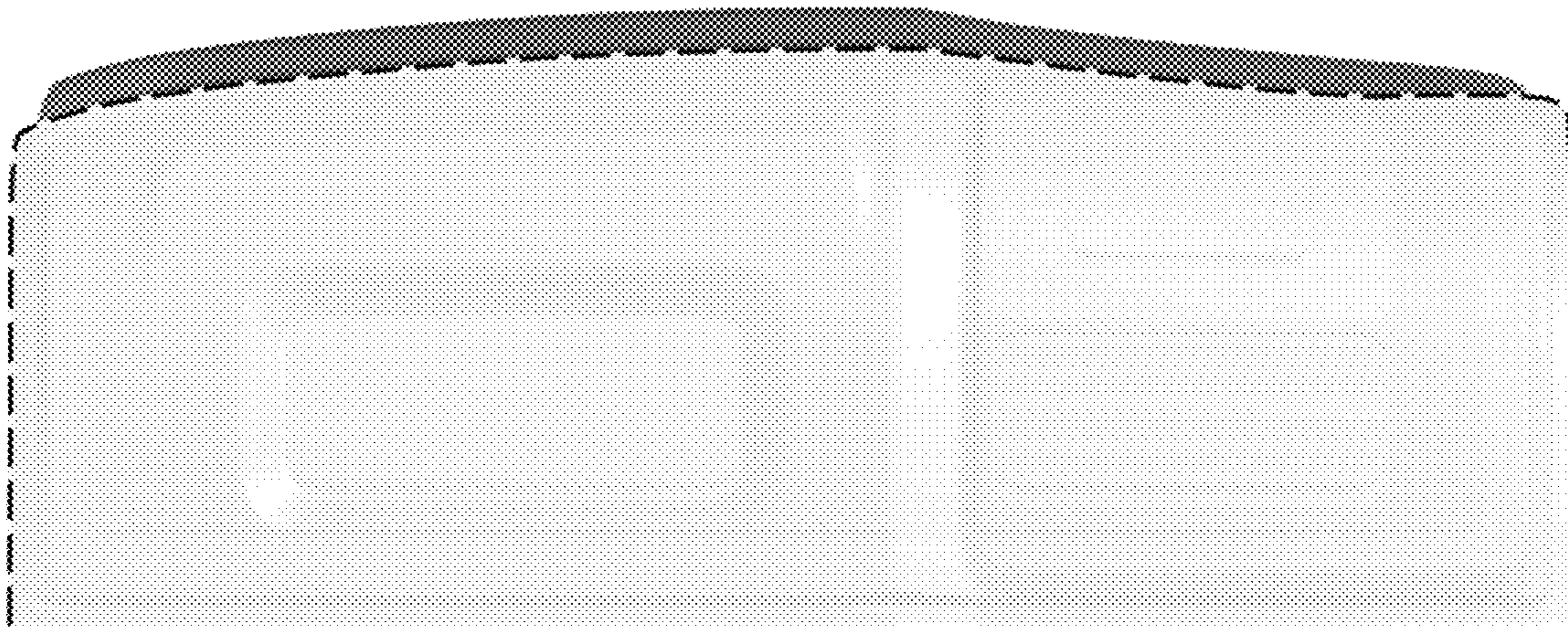
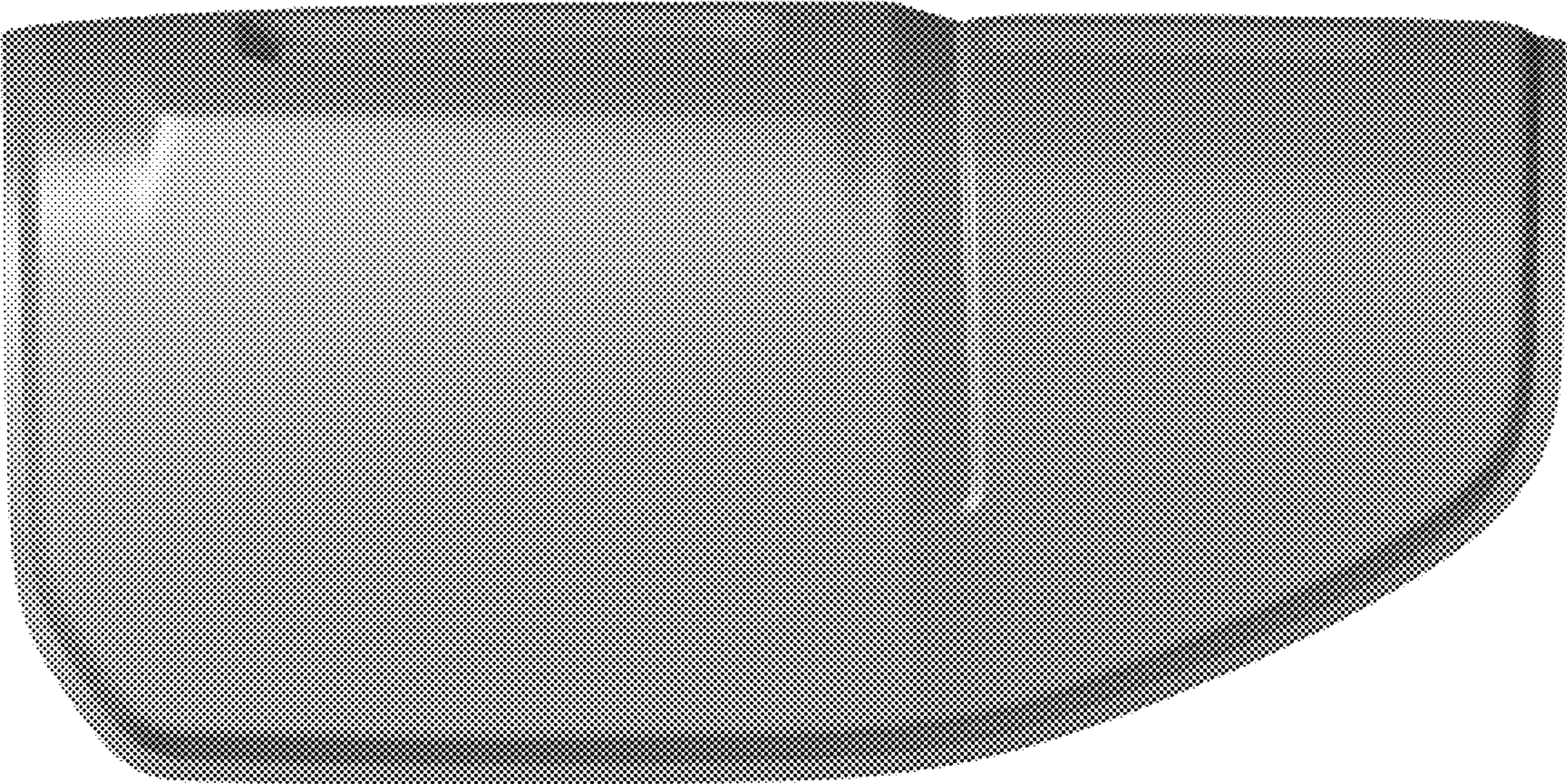



Fig. 43





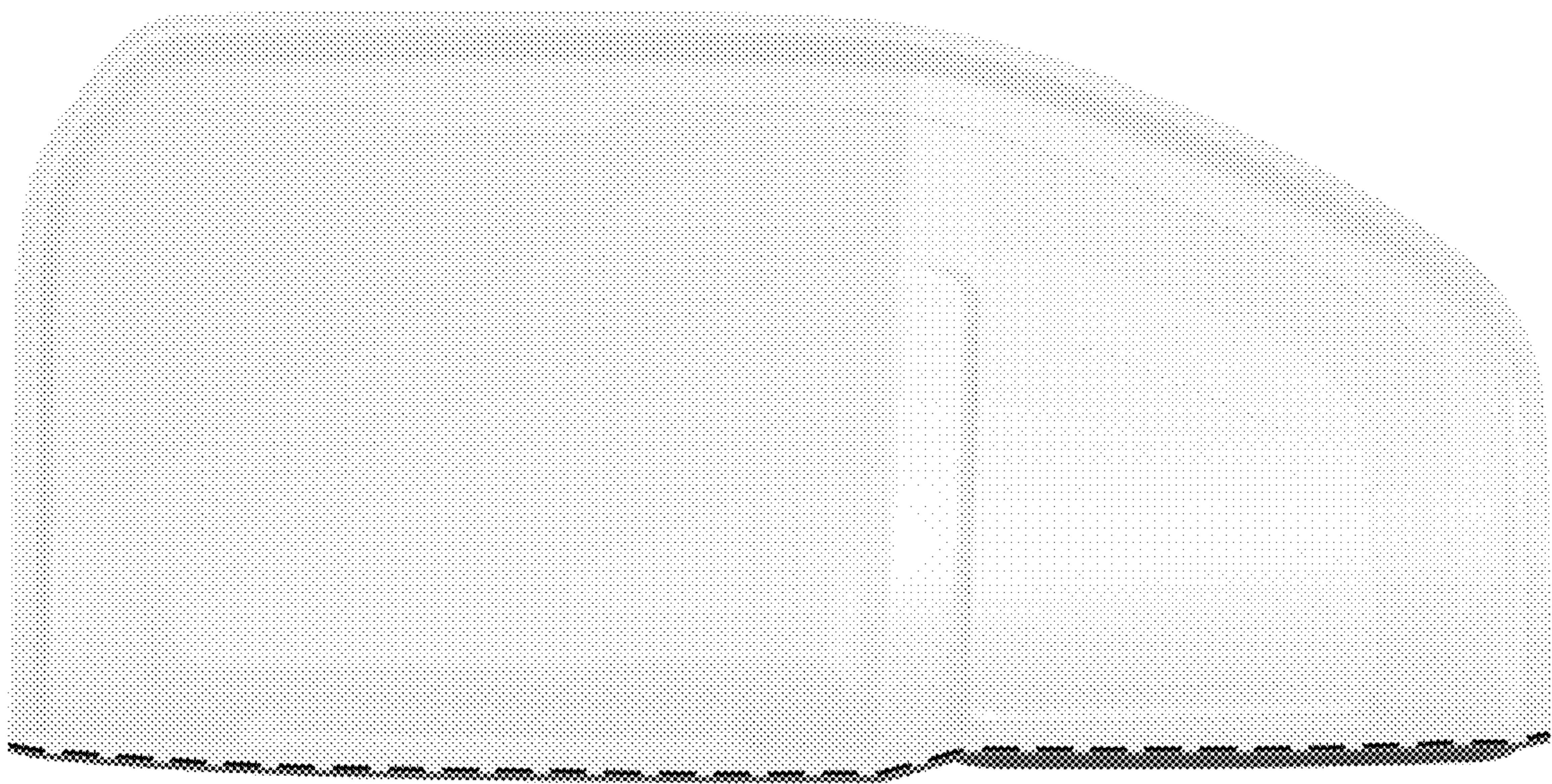

Fig. 44

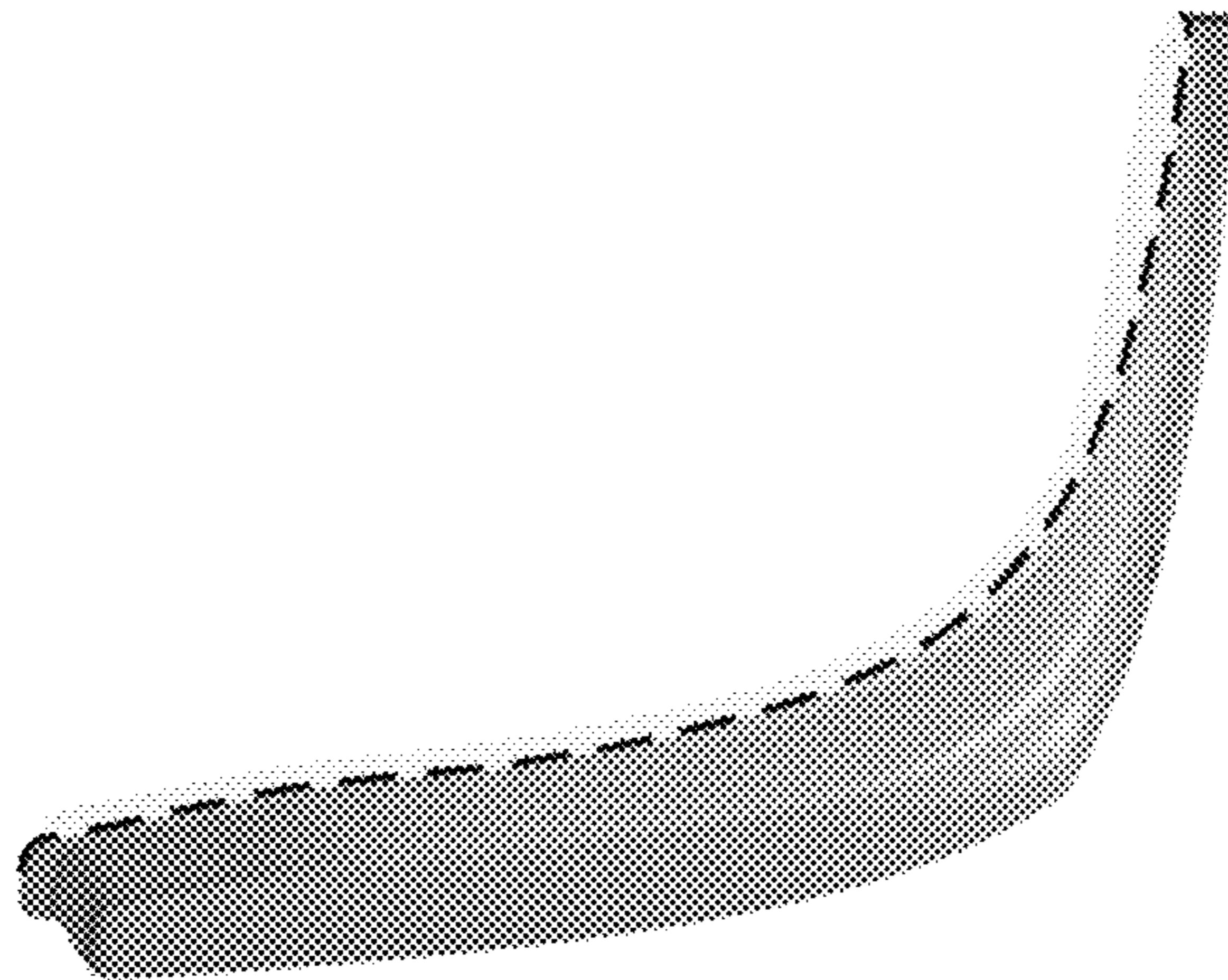

Fig. 45



Fig. 46

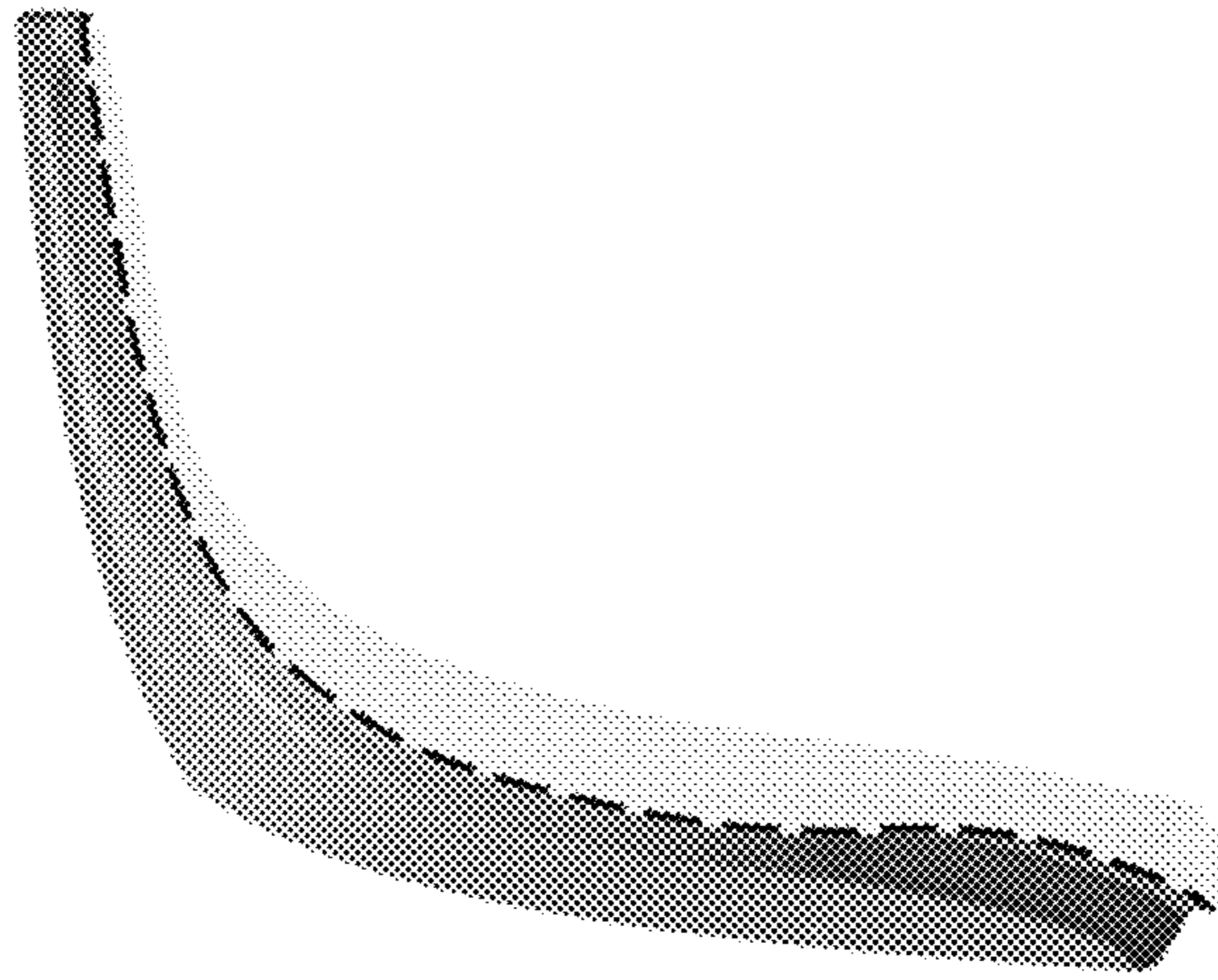

Fig. 47

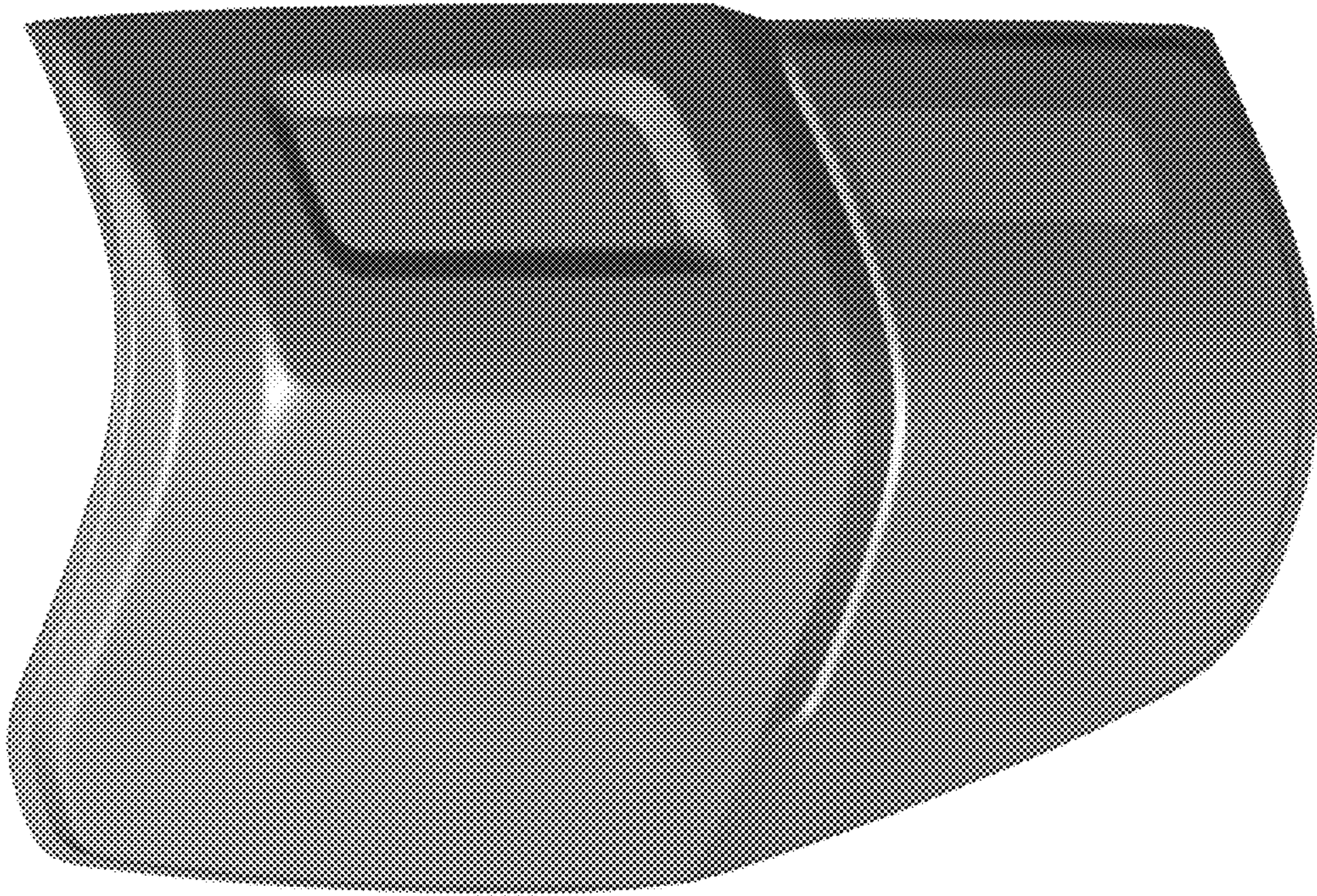



Fig. 48

