



US00D868938S

(12) **United States Design Patent** (10) **Patent No.:** **US D868,938 S**
Tentler (45) **Date of Patent:** **** Dec. 3, 2019**

(54) **FAUCET**
(71) Applicant: **DELTA FAUCET COMPANY,**
Indianapolis, IN (US)
(72) Inventor: **Anthony Joseph Tentler,** Windfall, IN
(US)
(73) Assignee: **DELTA FAUCET COMPANY,**
Indianapolis, IN (US)
(**) Term: **15 Years**
(21) Appl. No.: **29/638,153**
(22) Filed: **Feb. 24, 2018**
(51) **LOC (12) Cl.** **23-01**
(52) **U.S. Cl.**
USPC **D23/238**
(58) **Field of Classification Search**
USPC D23/238-243, 255, 257, 250, 252, 254;
D8/307-308
CPC F16K 31/602; F16K 31/605; F16K 31/607;
E03C 1/0412
See application file for complete search history.

(56) **References Cited**

U.S. PATENT DOCUMENTS

D530,786 S * 10/2006 Gilbert D23/238
D580,023 S * 11/2008 Gilbert D23/255

D583,021 S * 12/2008 Downey D23/252
D683,825 S * 6/2013 Sofield D23/255
D693,907 S * 11/2013 Mendoza D23/238
D707,799 S * 6/2014 Hanna D23/255
D754,820 S * 4/2016 Bahler D23/238
D786,405 S * 5/2017 Schaubach D23/238
D786,407 S * 5/2017 Clarke D23/252
D793,538 S * 8/2017 Fritz D23/252
D840,508 S * 2/2019 Garland D23/238

* cited by examiner

Primary Examiner — Robert A Delehanty
(74) *Attorney, Agent, or Firm* — Edgar A. Zarins; Nirav
D. Parikh

(57) **CLAIM**

The ornamental design for a faucet, as shown and described.

DESCRIPTION

FIG. 1 is a front perspective view of a faucet showing my
new design;
FIG. 2 is a rear perspective view thereof;
FIG. 3 is a front elevational view thereof;
FIG. 4 is a left side view thereof;
FIG. 5 is a rear view thereof;
FIG. 6 is a right side view thereof; and,
FIG. 7 is a top plan view thereof.

1 Claim, 4 Drawing Sheets

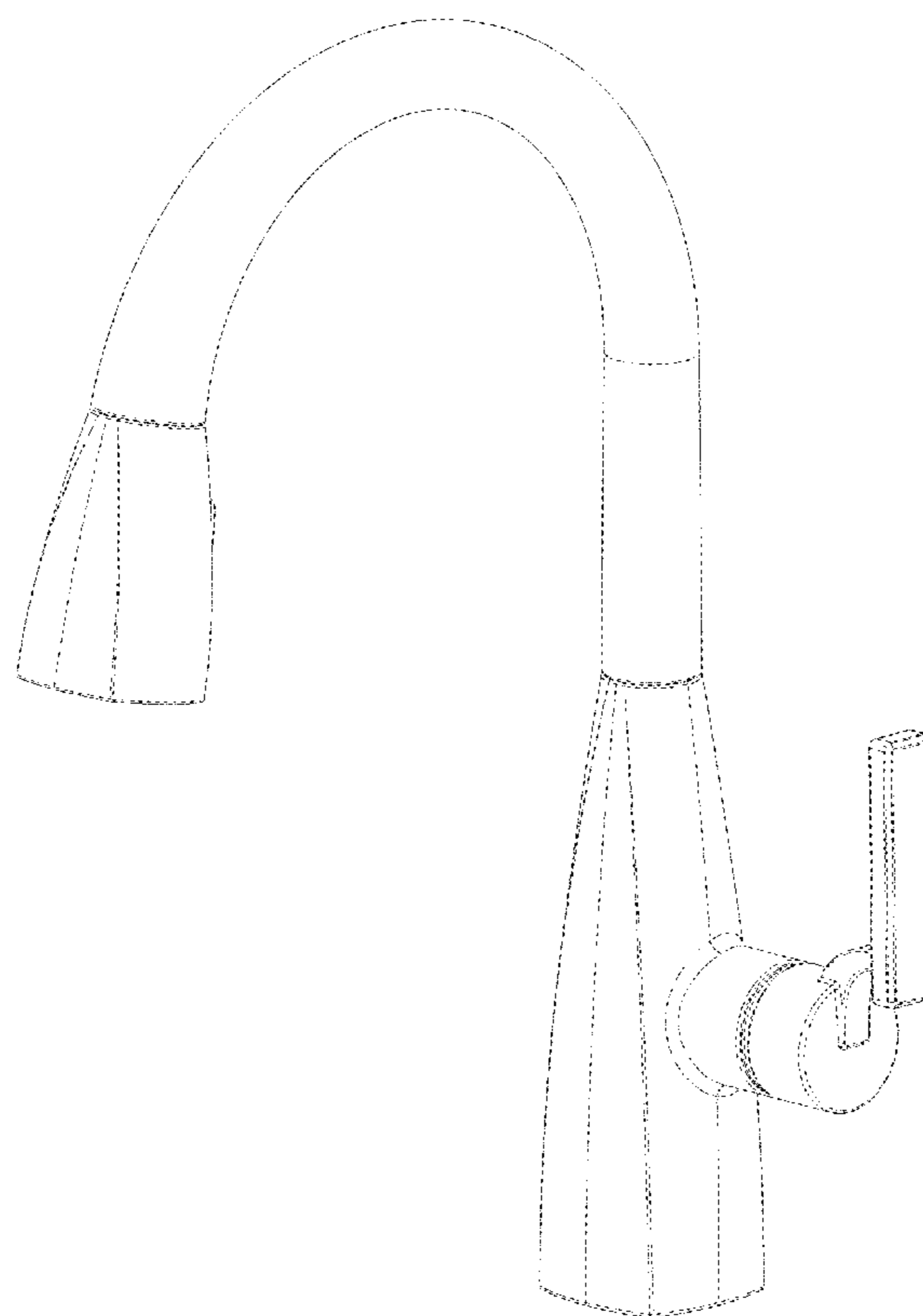

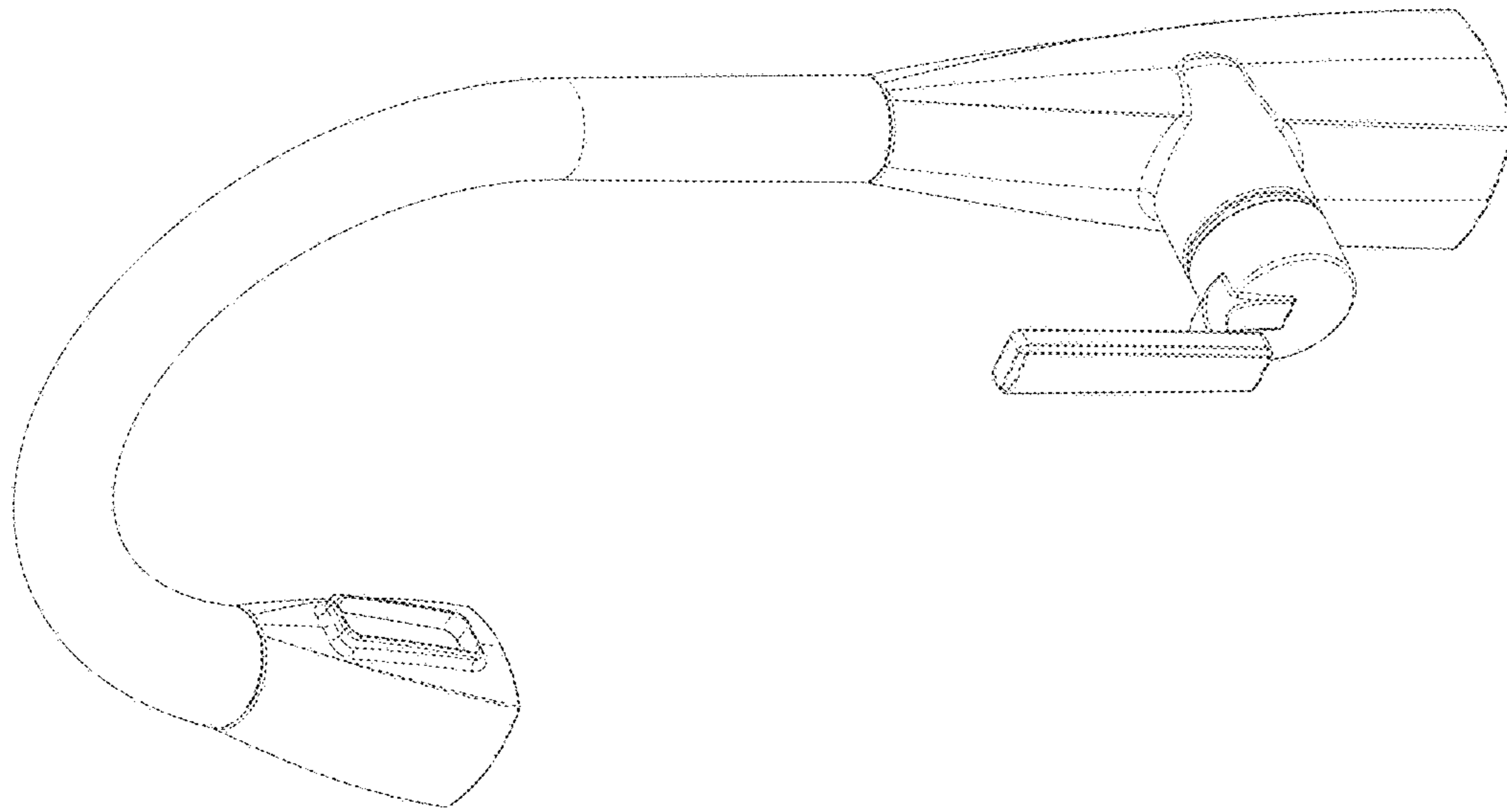

FIG - 2

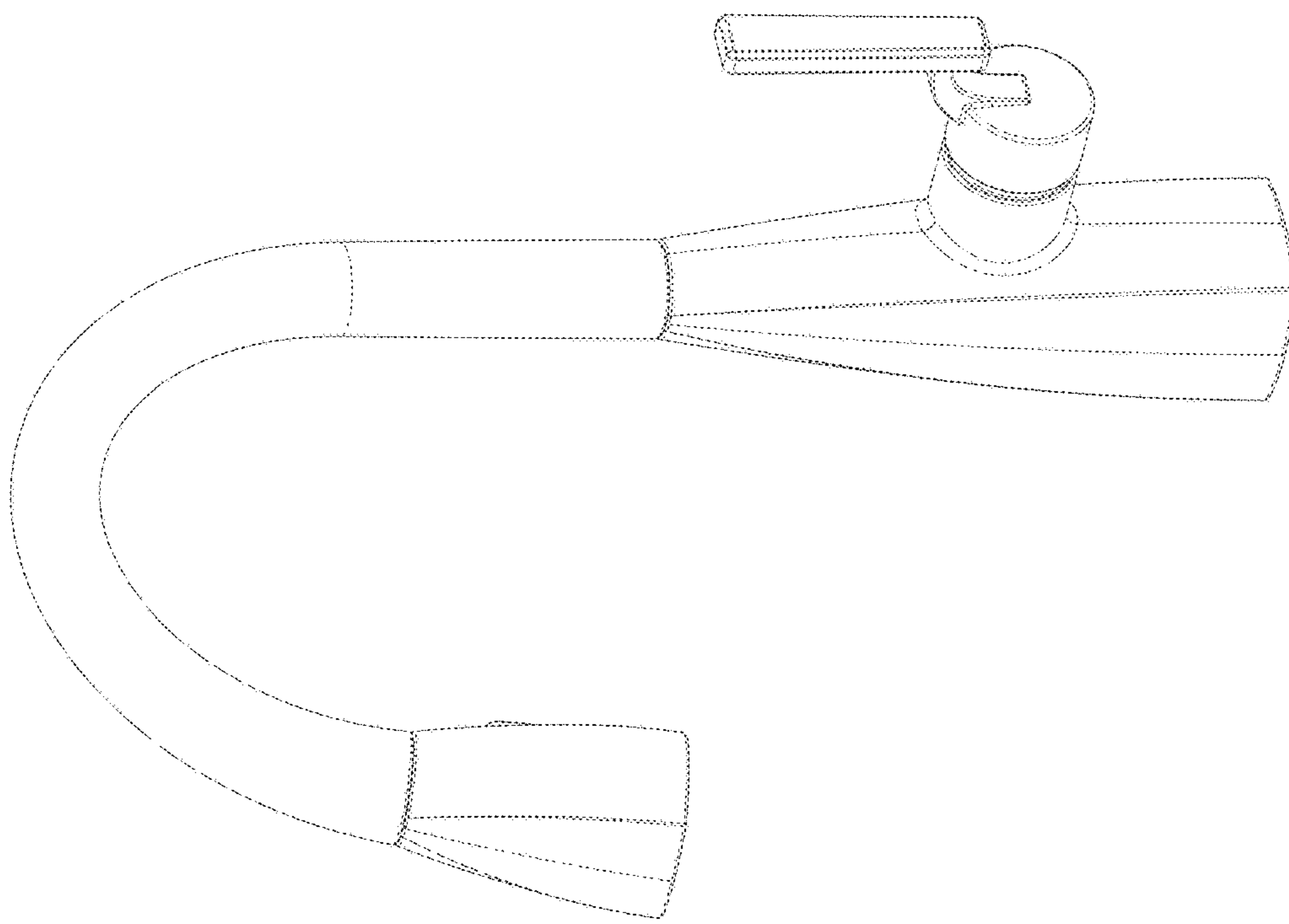

FIG - 1

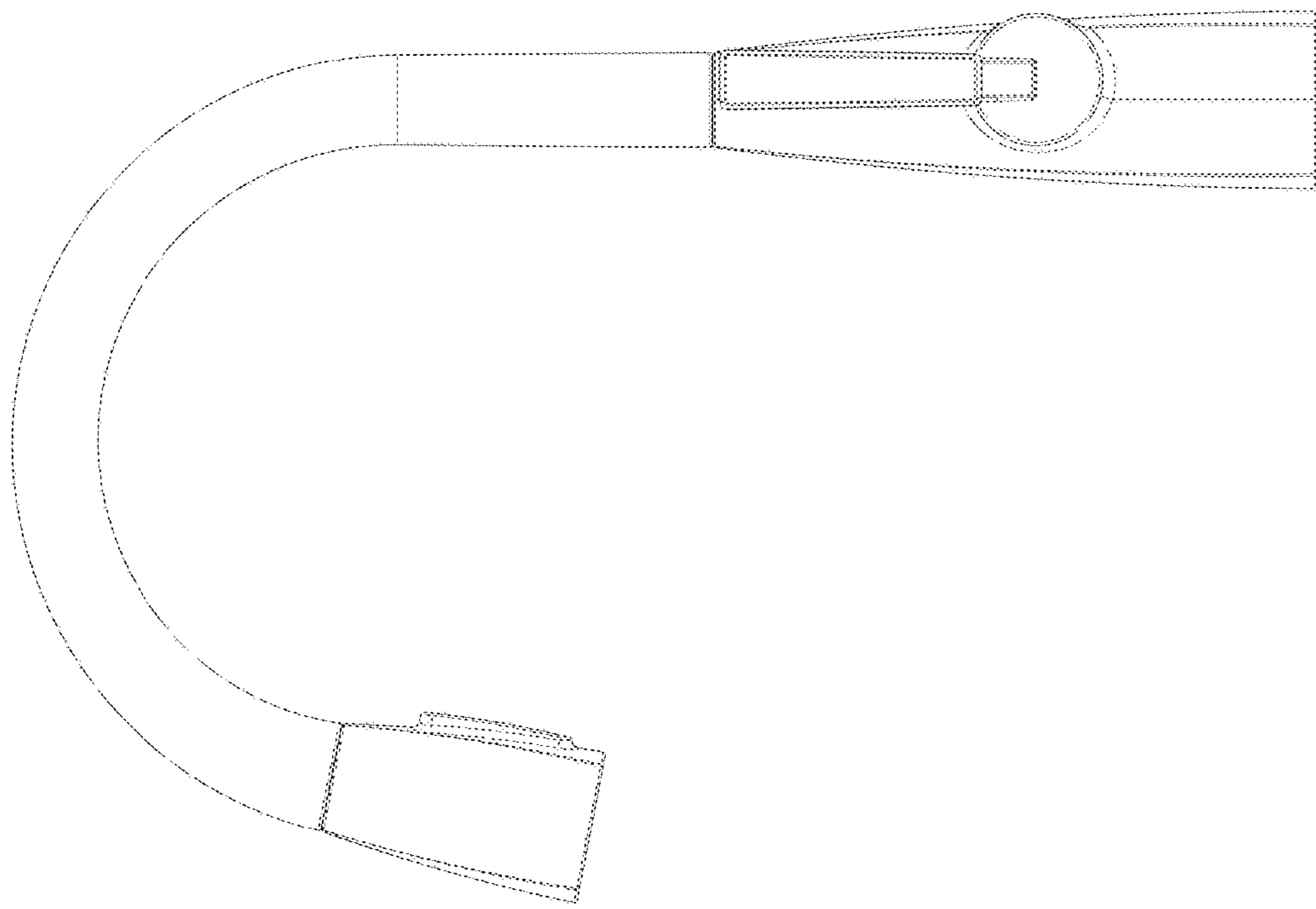

FIG - 4

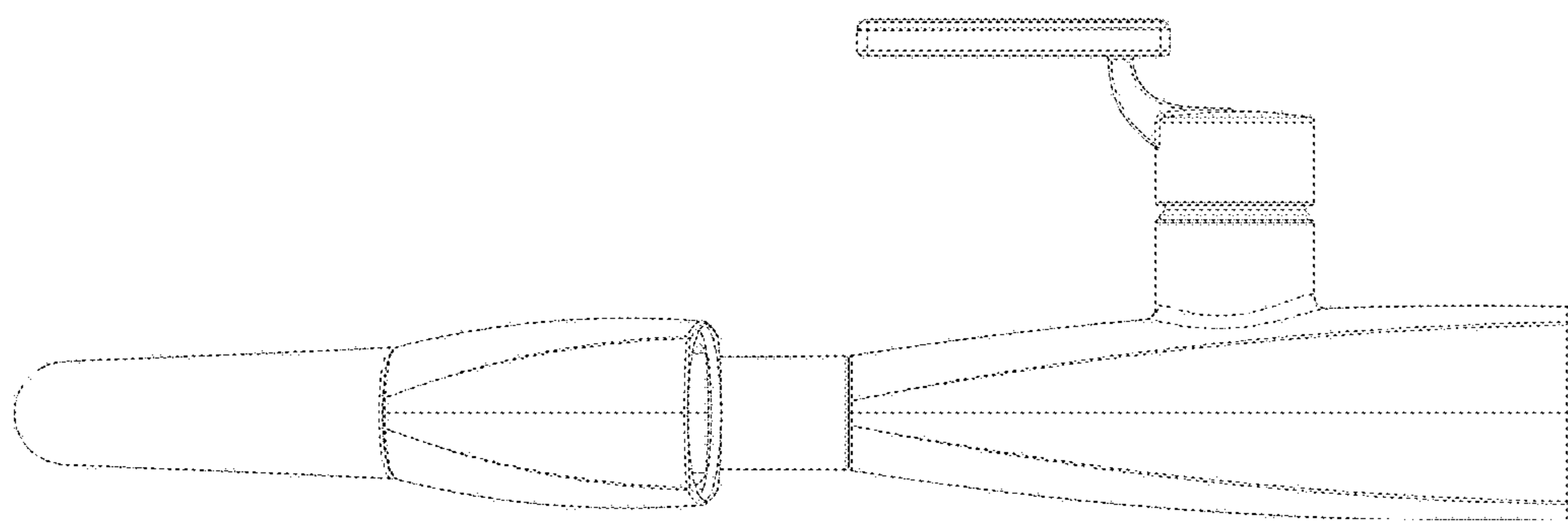

FIG - 3

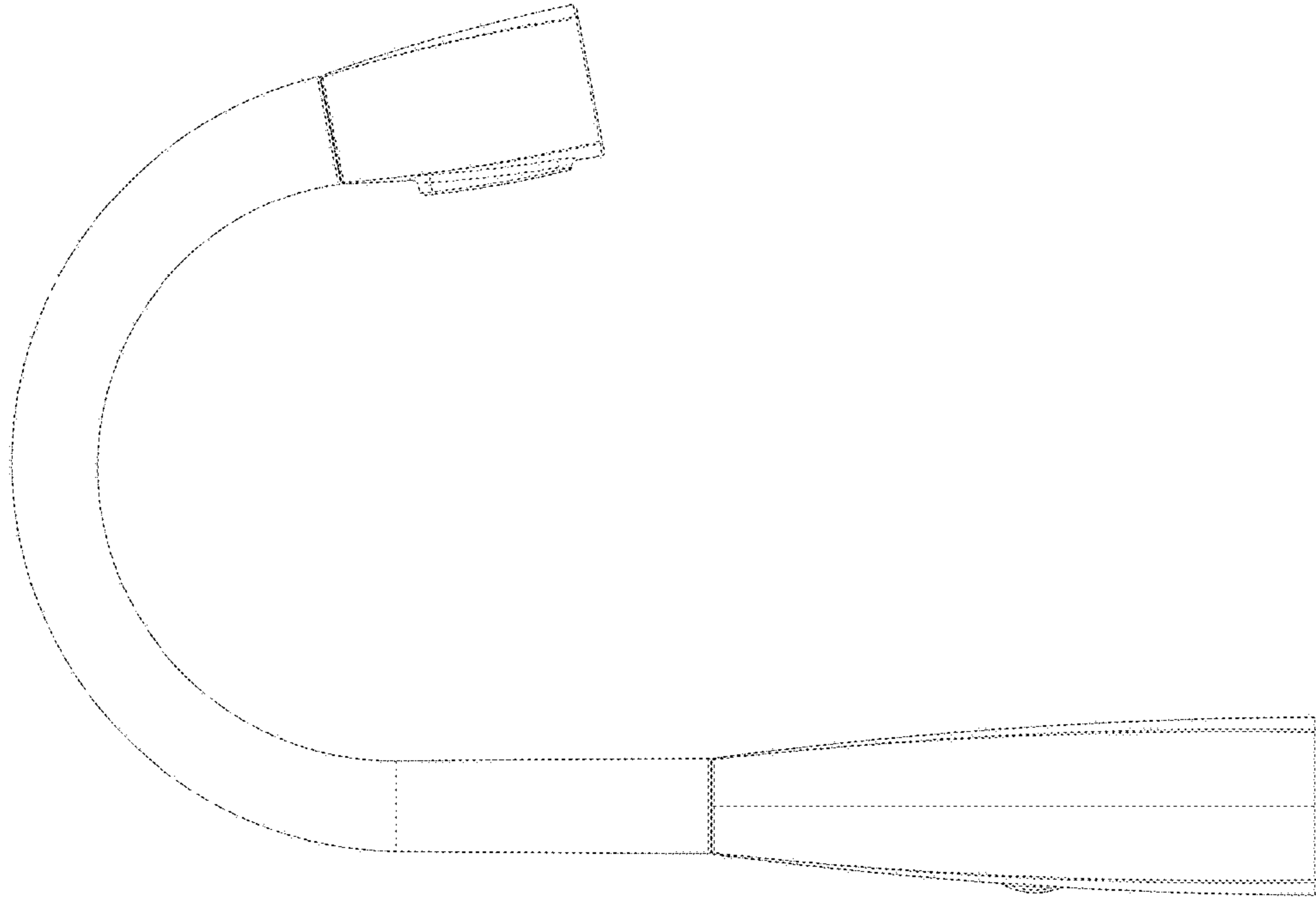

FIG - 6

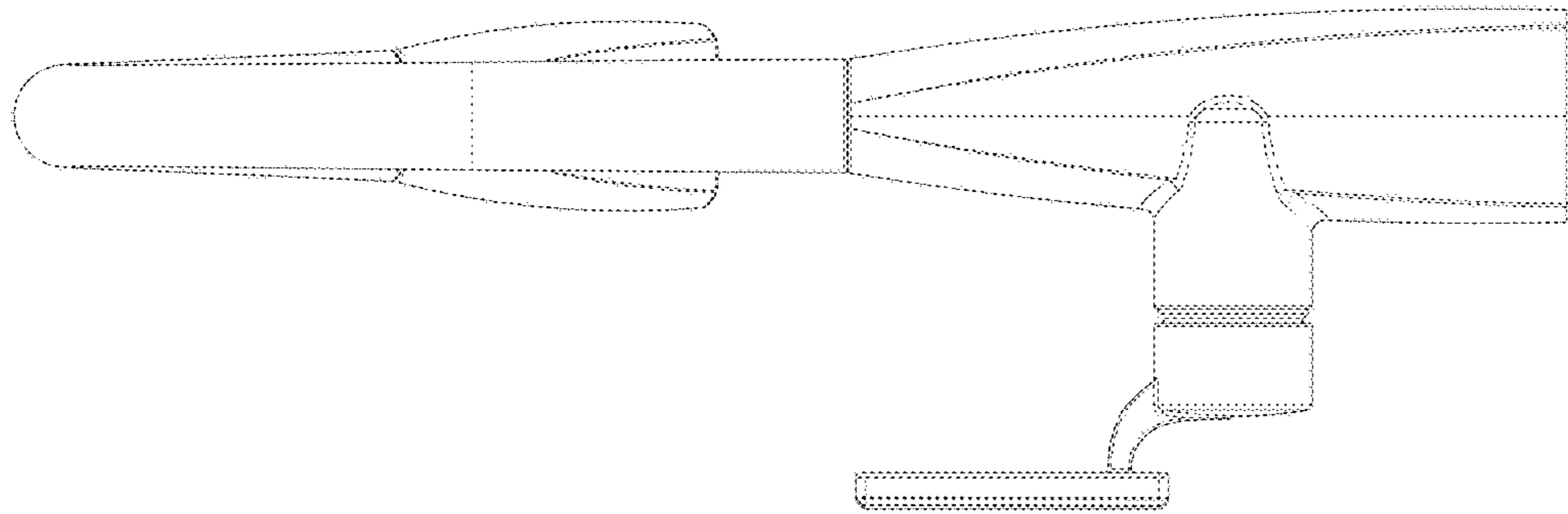

FIG - 5

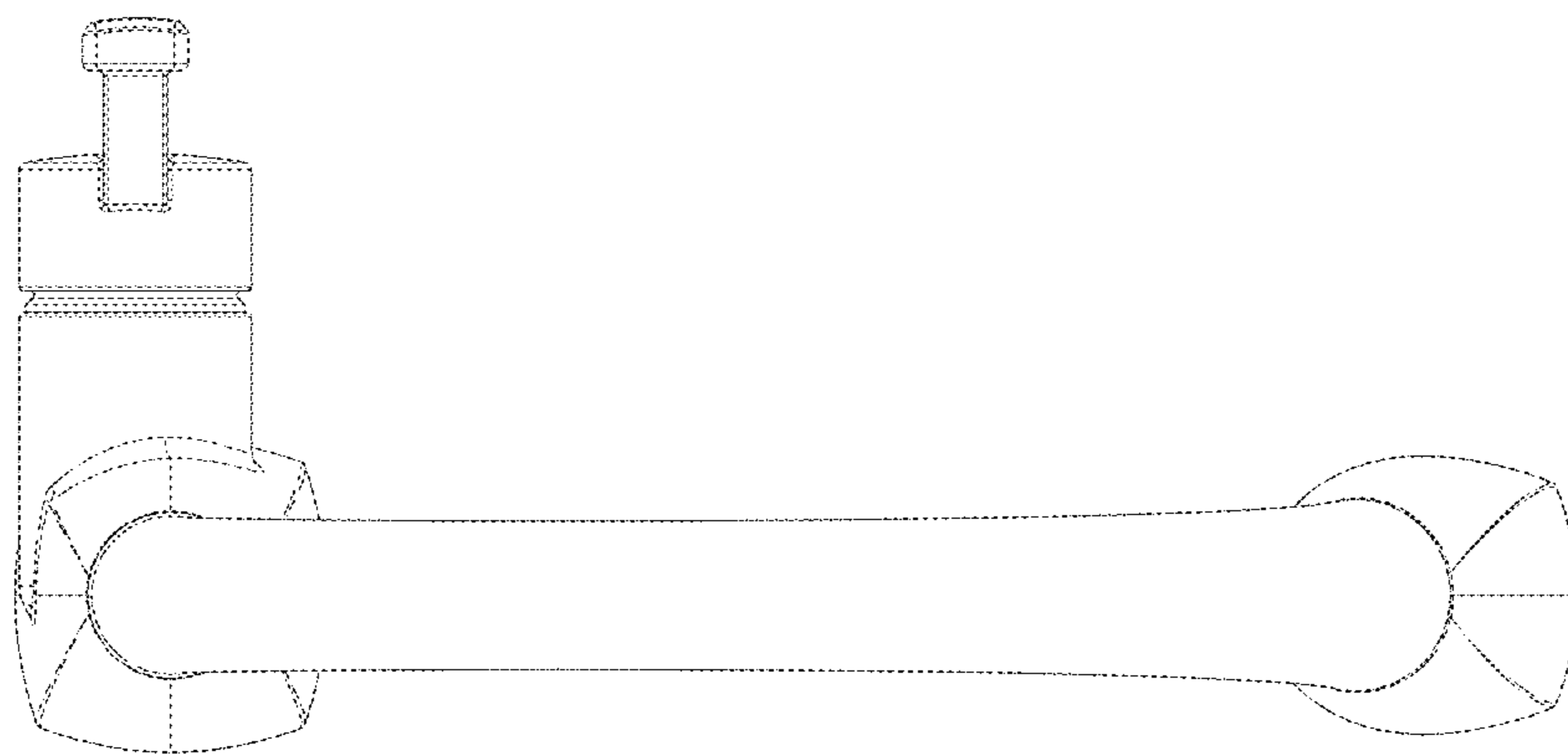

FIG - 7