



US00D868897S

(12) **United States Design Patent**  
**Schlangen**

(10) **Patent No.:** **US D868,897 S**

(45) **Date of Patent:** **\*\* Dec. 3, 2019**

(54) **ARCHERY TARGET**

(71) Applicant: **Jacob Schlangen**, Avon, MN (US)

(72) Inventor: **Jacob Schlangen**, Avon, MN (US)

(\*\*) Term: **15 Years**

(21) Appl. No.: **29/639,691**

(22) Filed: **Mar. 8, 2018**

(51) **LOC (12) Cl.** ..... **21-01**

(52) **U.S. Cl.**  
USPC ..... **D21/302**

(58) **Field of Classification Search**  
USPC ..... D21/302, 303, 306, 309, 322, 325, 338,  
D21/363, 396, 385, 397, 681, 706, 707,  
D21/789, 793, 794; D9/423, 430, 439;  
D11/90; D32/32, 156, 157; D30/121;  
D14/172; 273/348, 336-339, 352-353,  
273/398-400, 402, 408; 206/505, 514;  
446/69; 473/594; 83/651.1, 171  
CPC ..... A63B 67/06; A63B 63/007; A63F 9/0204  
See application file for complete search history.

(56) **References Cited**

U.S. PATENT DOCUMENTS

5,533,430	A *	7/1996	Buch	.....	B25H 1/0021
					219/228
D426,933	S *	6/2000	Redfern	.....	D21/491
D498,503	S *	11/2004	Worth	.....	D21/303
D524,872	S *	7/2006	DiCarlo	.....	D21/343
D701,583	S *	3/2014	Wade	.....	D21/707

(Continued)

OTHER PUBLICATIONS

“Go hunt,Indoor Practice”, posted Dec. 10, 2015 [online], [retrieved May 6, 2019]. Retrieved from internet, [https://www.gohunt.com/read/skills/indoor-practice-the-surefire-approach-to-better-shooting#gs.9n673o.\\*](https://www.gohunt.com/read/skills/indoor-practice-the-surefire-approach-to-better-shooting#gs.9n673o.*)

(Continued)

*Primary Examiner* — Barbara Fox

*Assistant Examiner* — Mehri F Bajoul

(74) *Attorney, Agent, or Firm* — Vidas Arrett & Steinkraus P.A.

(57) **CLAIM**

The ornamental design for an archery target, as shown and described.

**DESCRIPTION**

FIG. 1 is a perspective view of the back, top and right side of an archery target showing the new design according to a first embodiment.

FIG. 2 is a perspective view of the front, top and right side thereof.

FIG. 3 is a back view thereof.

FIG. 4 is a front view thereof.

FIG. 5 is a top view of the archery target, the bottom view being identical.

FIG. 6 is a left view thereof.

FIG. 7 is a perspective view of the back top and right side of the archery target showing the new design according to a second embodiment.

FIG. 8 is a perspective view of the front, top and right side thereof.

FIG. 9 is a back view thereof.

FIG. 10 is a front view thereof.

FIG. 11 is a top view of the archery target, the bottom view being identical.

FIG. 12 is a left view thereof.

FIG. 13 is a perspective view of the back top and right side of the archery target showing the new design according to a third embodiment.

FIG. 14 is a perspective view of the front, top and right side thereof.

FIG. 15 is a back view thereof.

FIG. 16 is a front view thereof.

FIG. 17 is a top view of the archery target, the bottom view being identical; and,

FIG. 18 is a left view thereof.

**1 Claim, 15 Drawing Sheets**

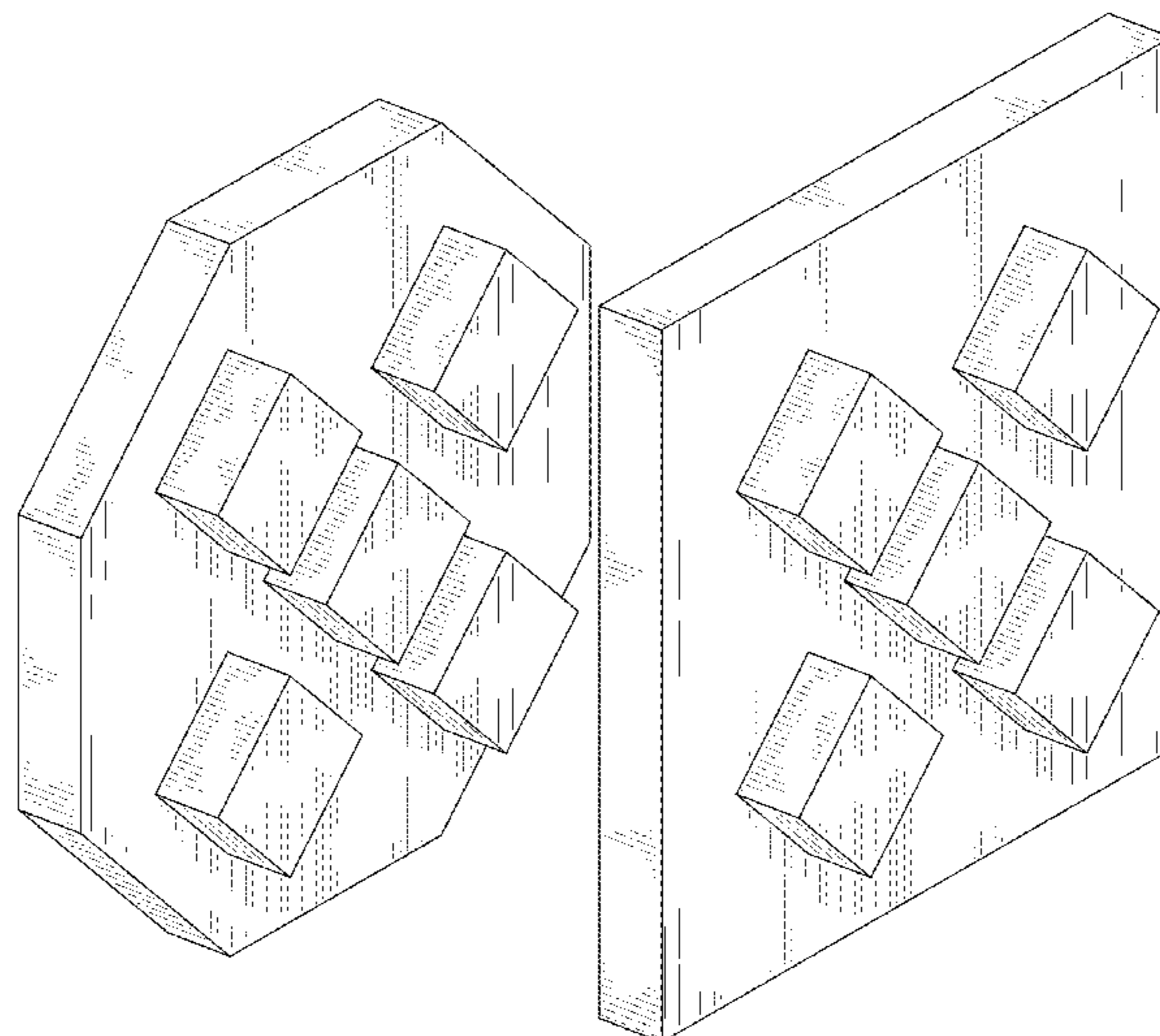

(56)

References Cited

U.S. PATENT DOCUMENTS

D741,170 S \* 10/2015 Thurin ..... D7/629  
 D771,199 S \* 11/2016 Ryaa ..... D21/504  
 D786,586 S \* 5/2017 Rosan ..... D6/641  
 D791,885 S \* 7/2017 Rosan ..... D21/500  
 D800,846 S \* 10/2017 Rosan ..... D21/500  
 D806,181 S \* 12/2017 Johannsen ..... D21/500  
 D809,162 S \* 1/2018 Rosan ..... D25/115  
 D809,988 S \* 2/2018 Angel ..... D12/217  
 D818,056 S \* 5/2018 Lo ..... D21/499  
 D830,477 S \* 10/2018 Jensen ..... D21/491  
 D841,101 S \* 2/2019 Ross ..... D21/500  
 D845,397 S \* 4/2019 Cohen ..... D21/484  
 2014/0051321 A1 \* 2/2014 Kelly ..... G09F 19/00  
 446/128  
 2015/0276357 A1 \* 10/2015 Peterson ..... F41J 3/0004  
 273/408  
 2017/0167831 A1 \* 6/2017 Schlangen ..... F41J 3/0004  
 2018/0128581 A1 \* 5/2018 Schlangen ..... F41J 3/0004

OTHER PUBLICATIONS

“Round Knob”, posted Dec. 10, 2018[online], [retrieved May 12, 2019. Retrieved from internet, [https://www.etsy.com/listing/649854155/solid-brass-cabinet-knobs-rounddoorga\\_order=most\\_relevant&ga\\_search\\_type=all&ga\\_view\\_type=gallery&ga\\_search\\_query=round+knobs&ref=sc\\_gallery-1-7&plkey=ca7728587a130f58e4172234af08c7bca](https://www.etsy.com/listing/649854155/solid-brass-cabinet-knobs-rounddoorga_order=most_relevant&ga_search_type=all&ga_view_type=gallery&ga_search_query=round+knobs&ref=sc_gallery-1-7&plkey=ca7728587a130f58e4172234af08c7bca).\*  
 “Hexagon”, posted Dec. 6, 2018[online], [retrieved May 12, 2019. Retrieved from internet, [https://www.etsy.com/listing/640174517/hexagon-cabinet-knob-hardware-solid?ga\\_order=most\\_relevant&ga\\_search\\_type=all&ga\\_view\\_type=gallery&ga\\_search\\_query=hexagon+knobs&ref=sc\\_gallery-2-6&plkey=dfd38db12ccc71c52daf721991c7fe374](https://www.etsy.com/listing/640174517/hexagon-cabinet-knob-hardware-solid?ga_order=most_relevant&ga_search_type=all&ga_view_type=gallery&ga_search_query=hexagon+knobs&ref=sc_gallery-2-6&plkey=dfd38db12ccc71c52daf721991c7fe374).\*  
 “Duplo Blocks”, posted Oct. 25, 2011[online], [retrieved May 12, 2019. Retrieved from internet, , <https://bricks.stackexchange.com/questions/38/are-duplo-blocks-compatible-with-lego-blocks-in-any-way>.\*

\* cited by examiner

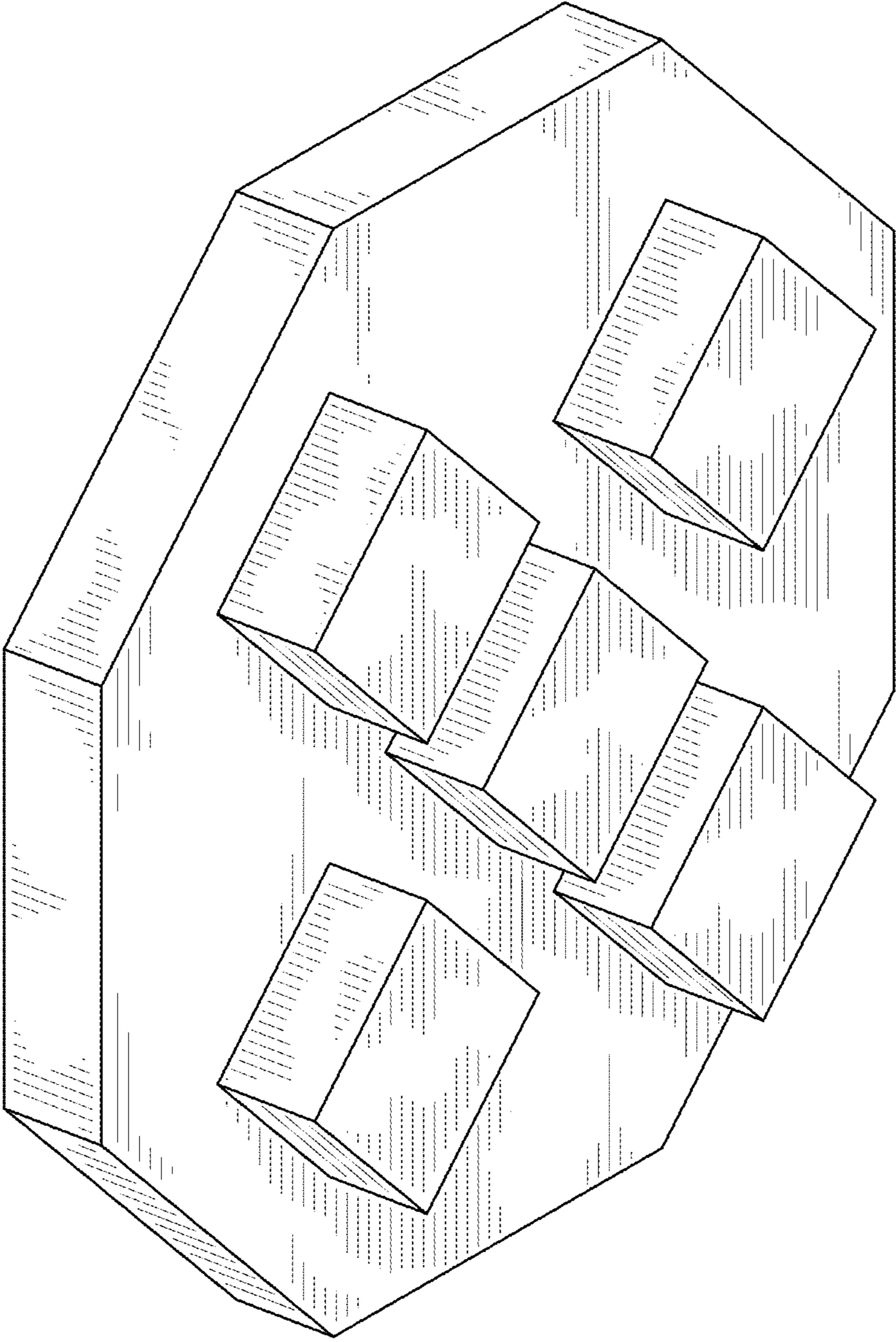

FIG. 1

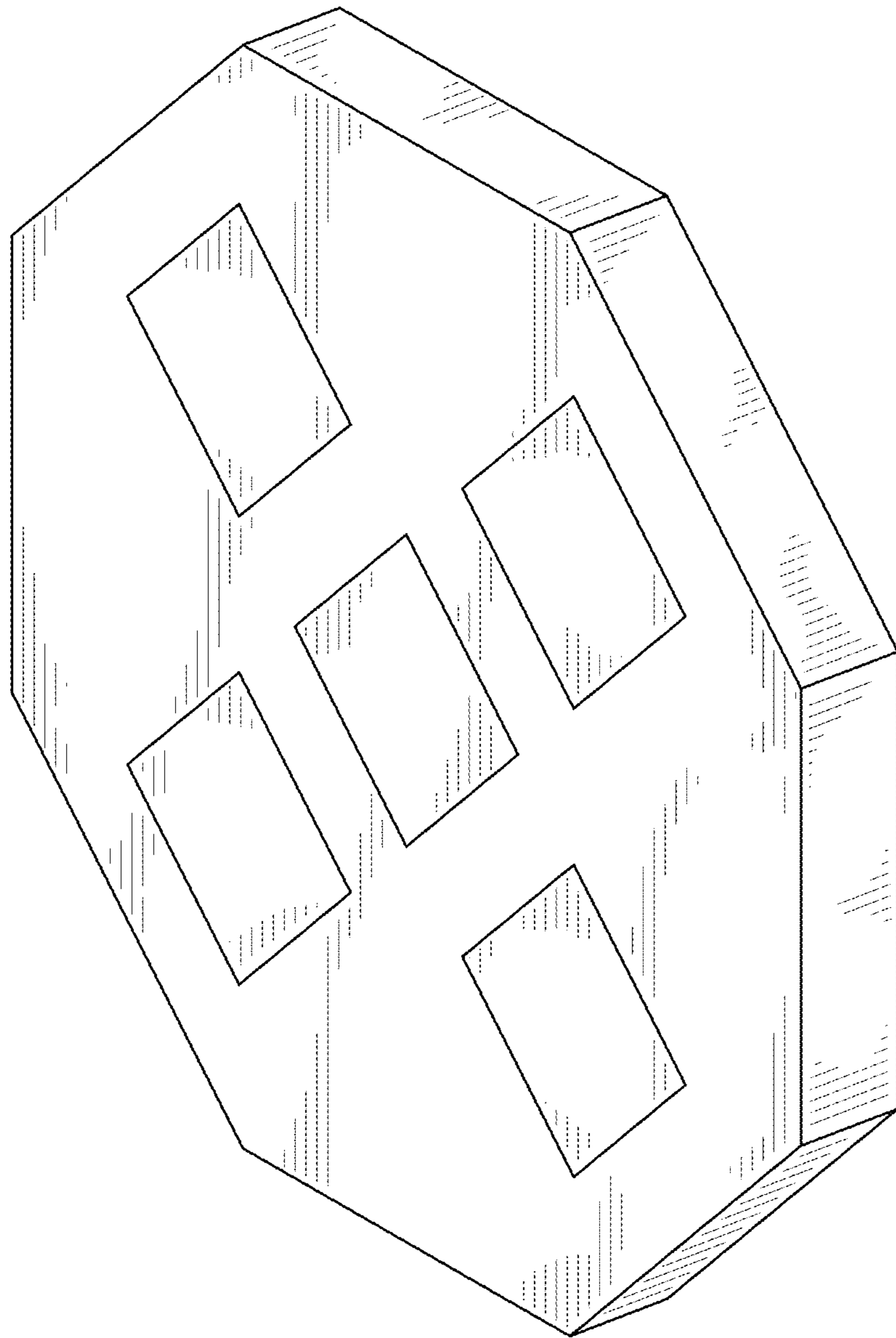

FIG. 2

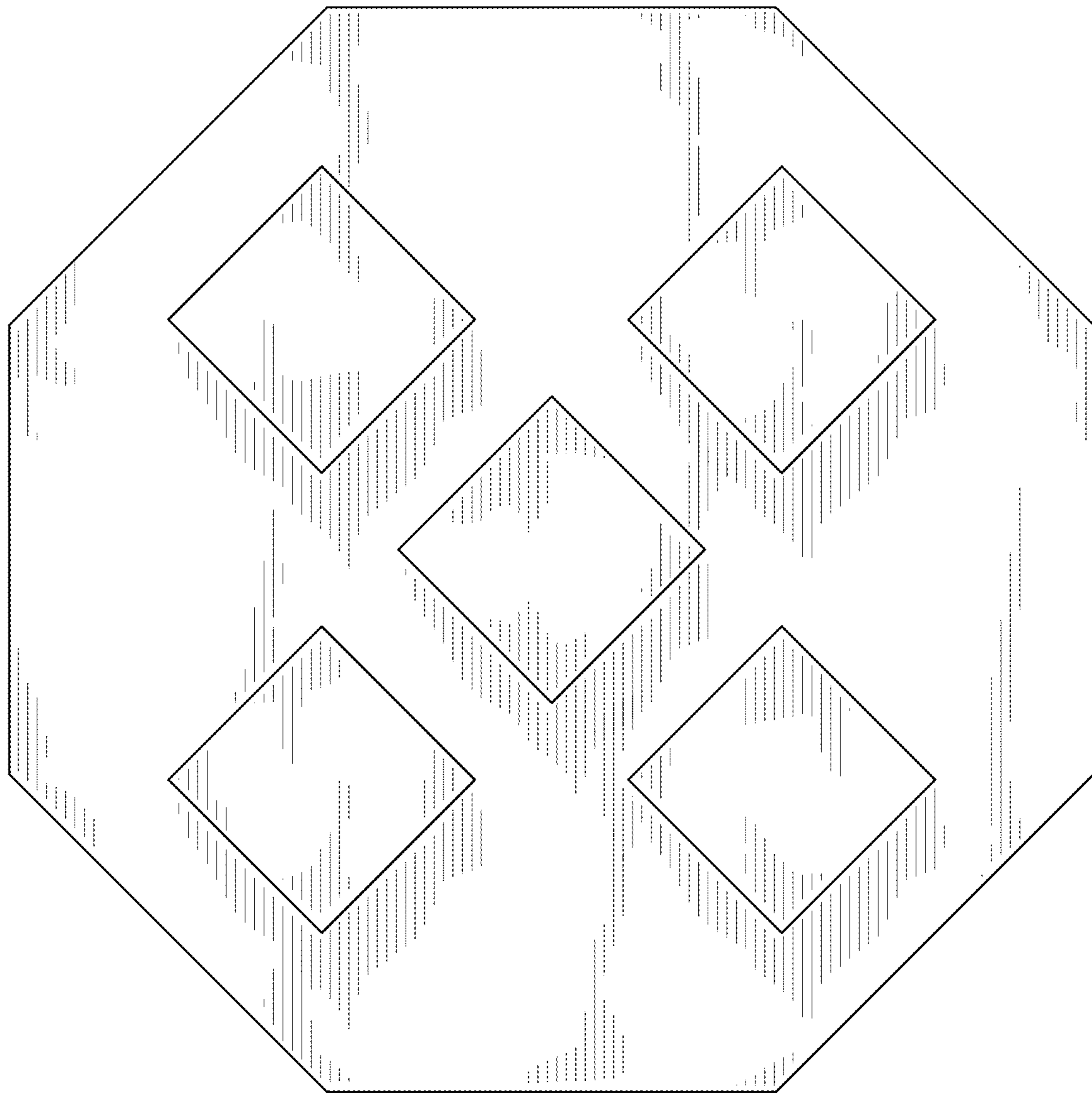

FIG. 3

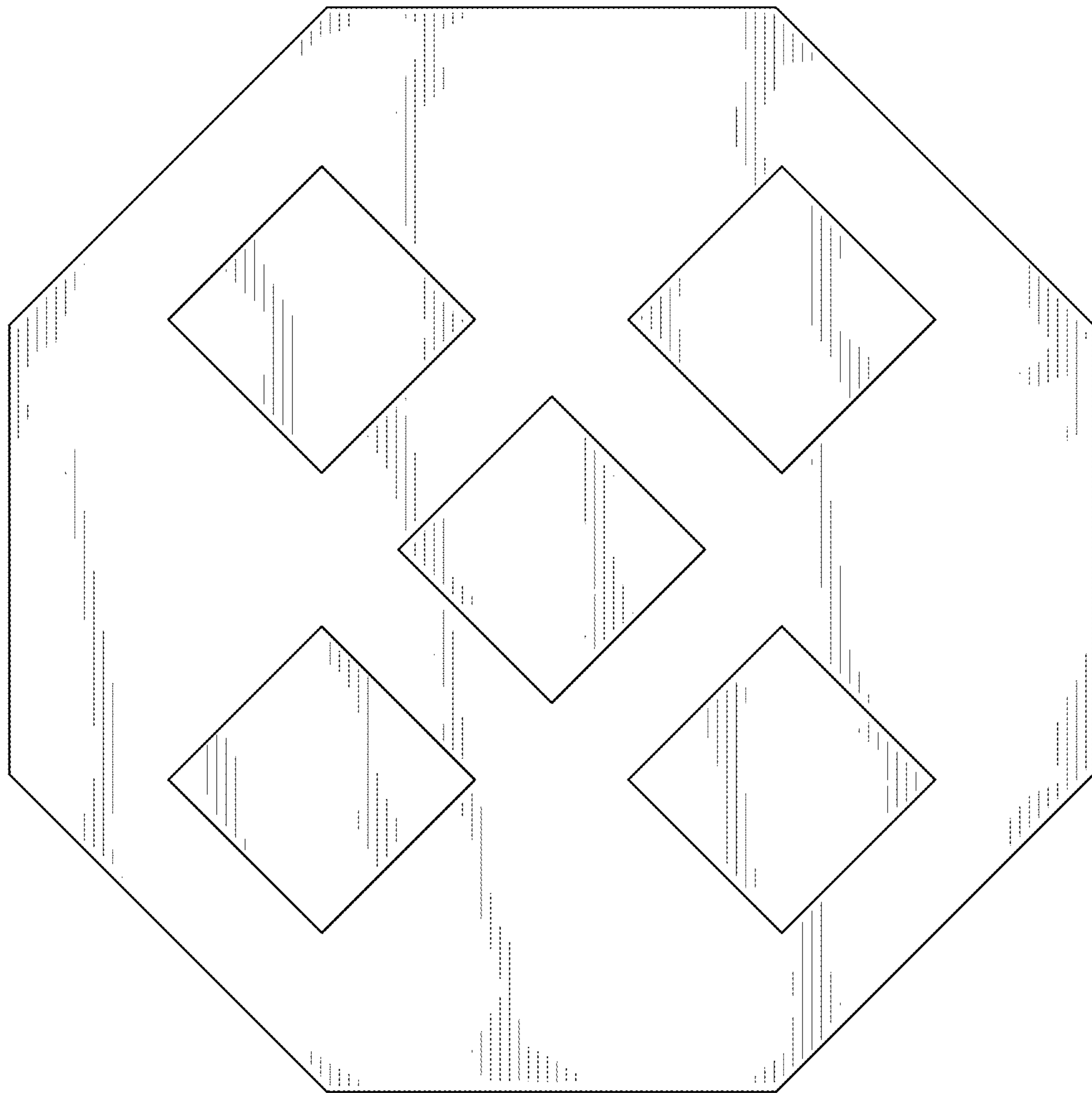

FIG. 4

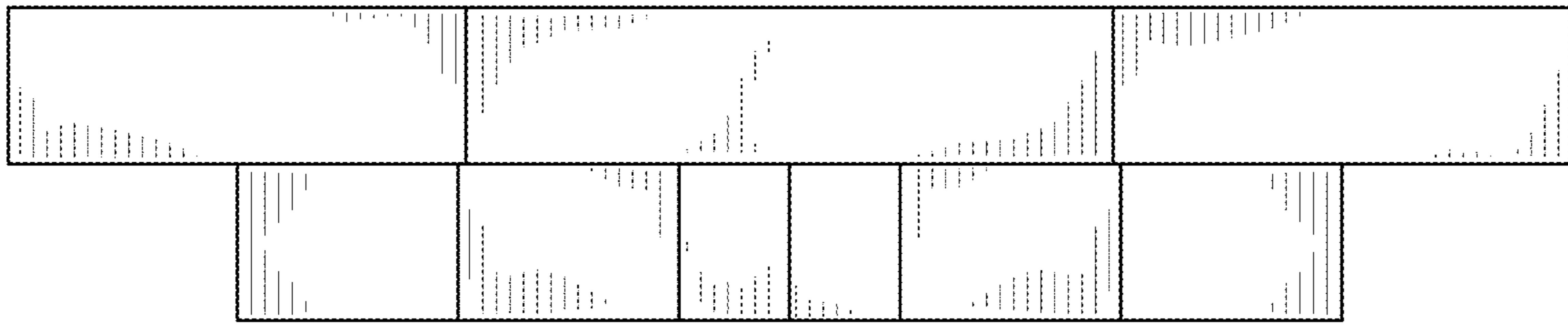

FIG. 5

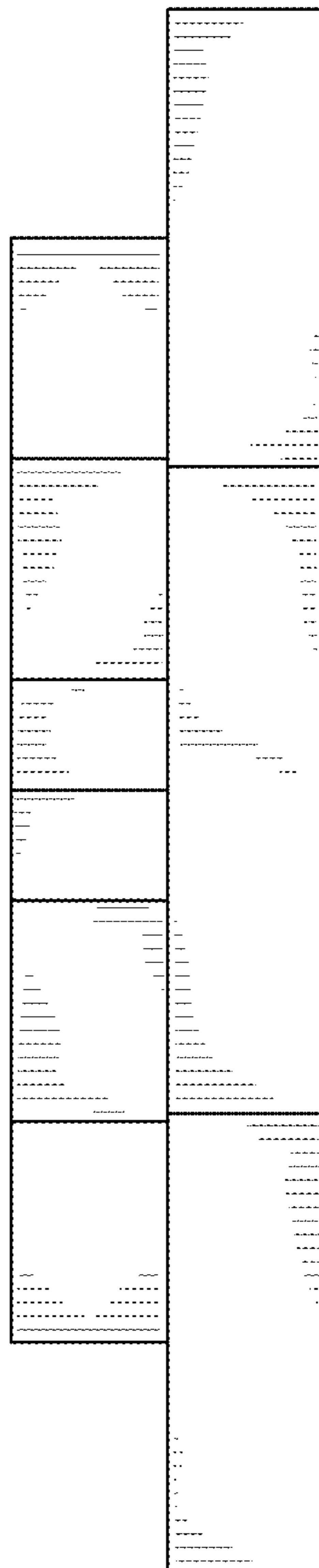

FIG. 6

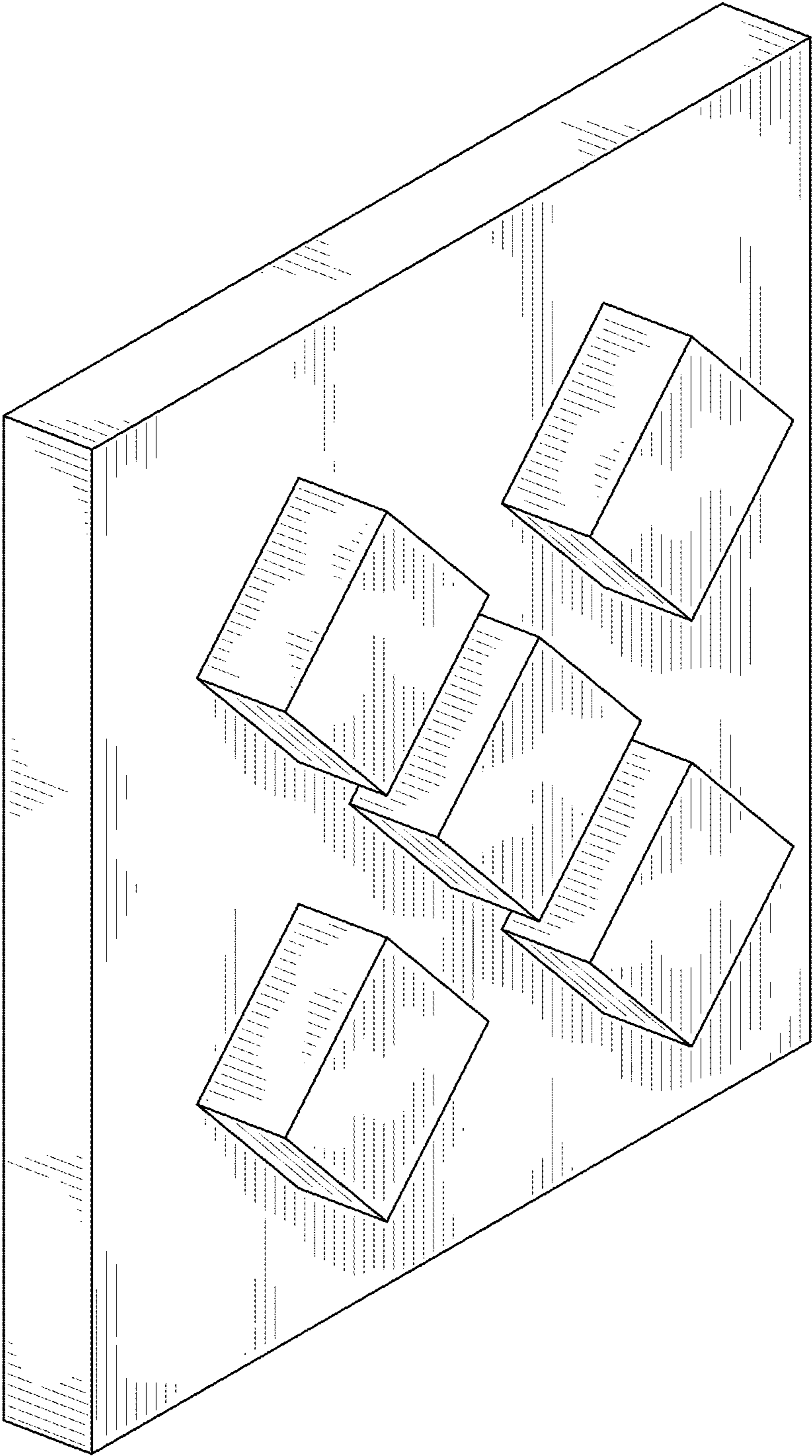

FIG. 7



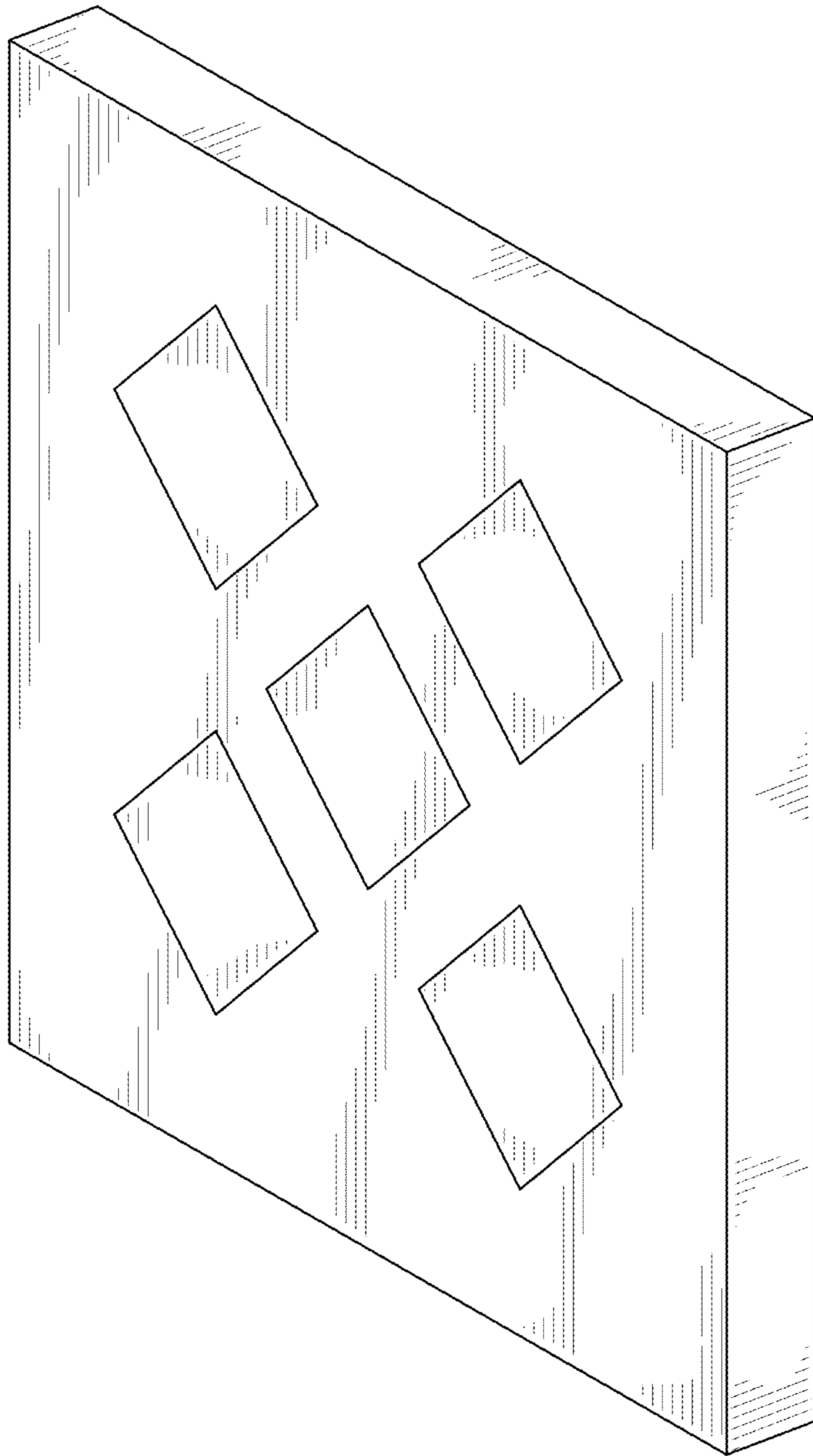

FIG. 8

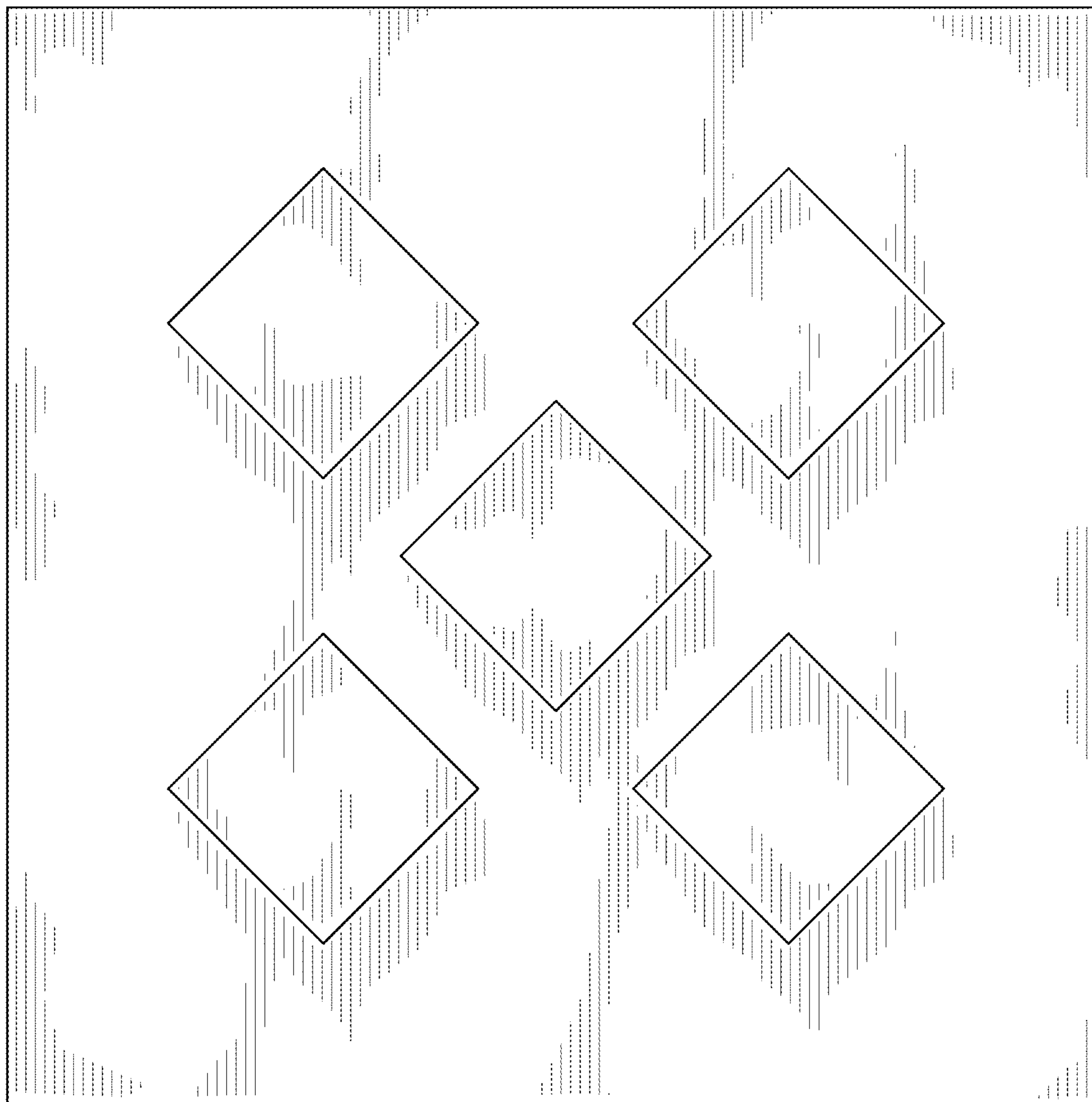

FIG. 9

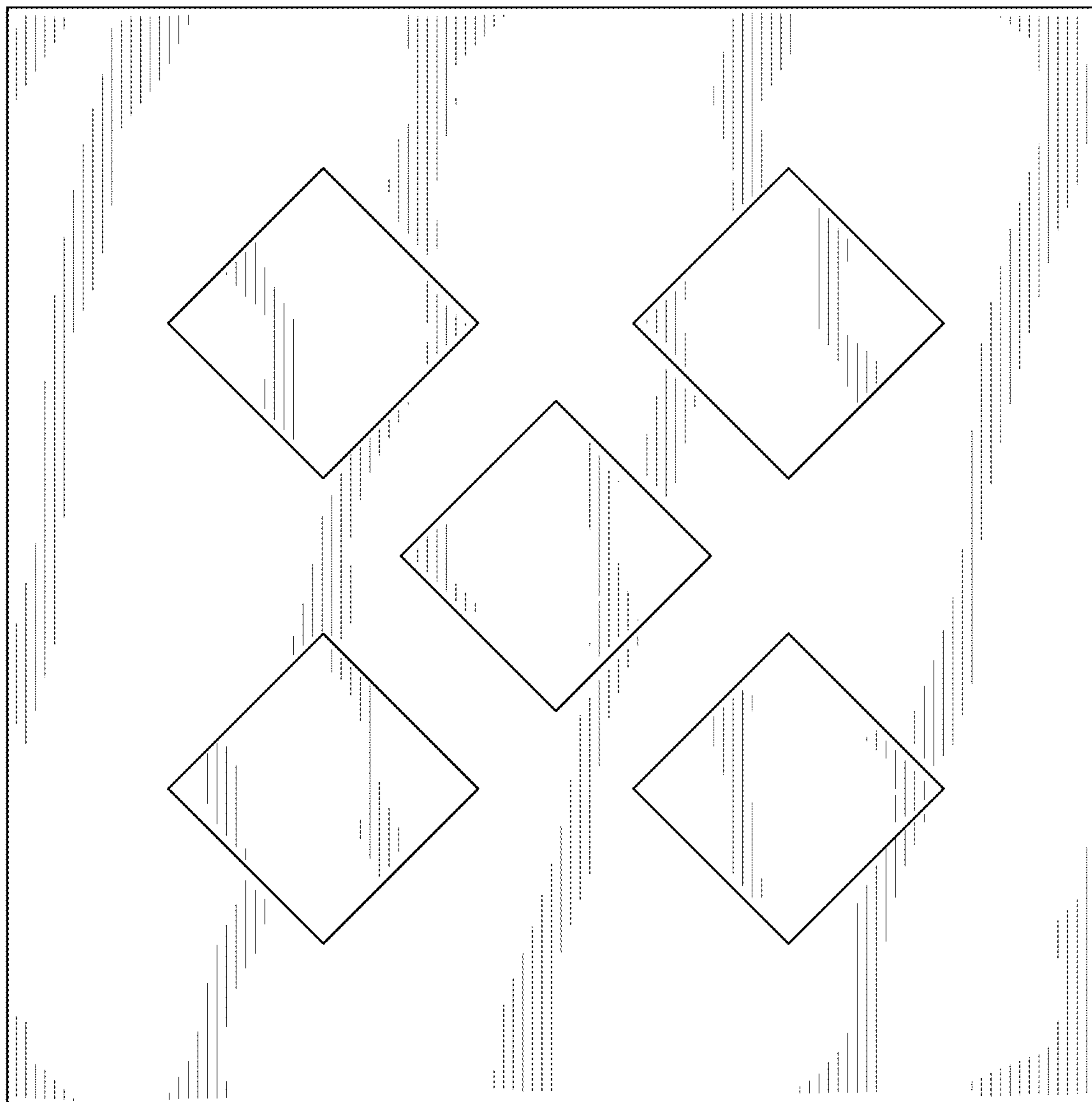

FIG. 10

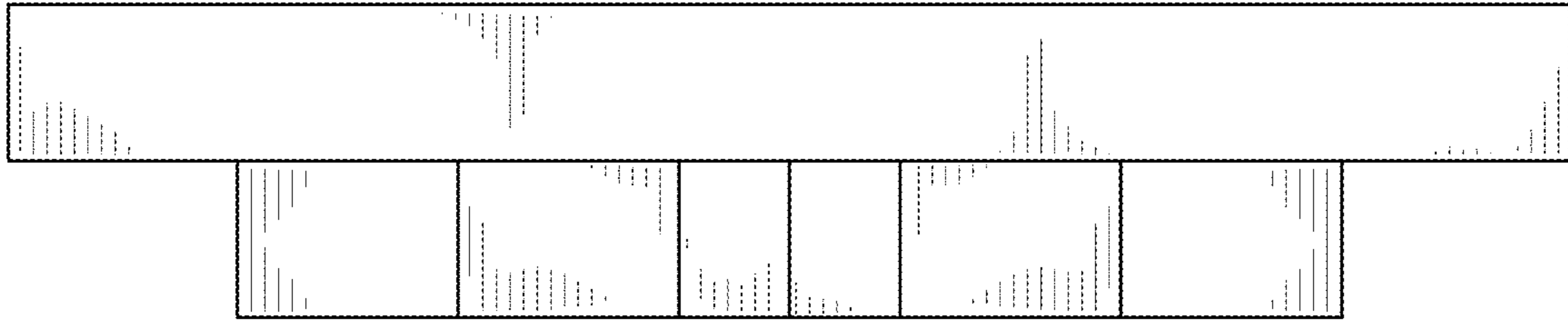

FIG. 11

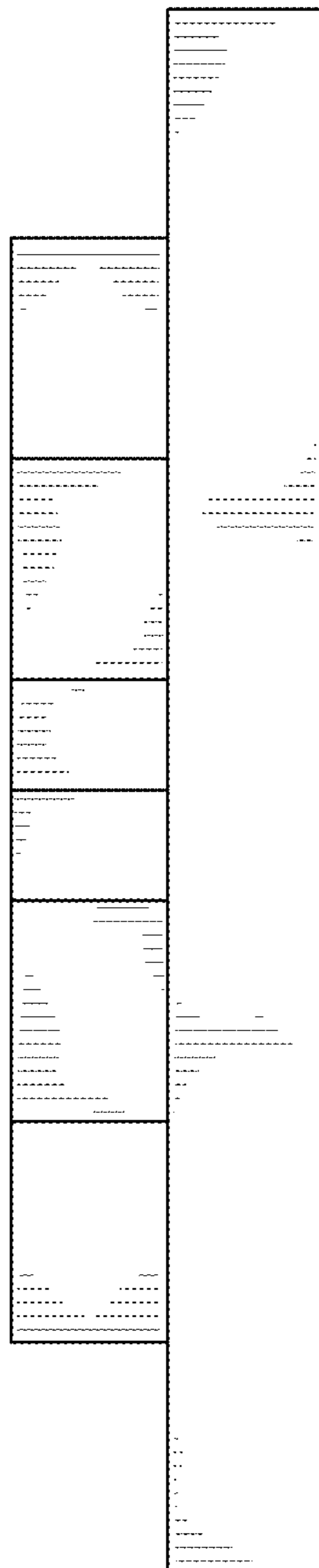

FIG. 12

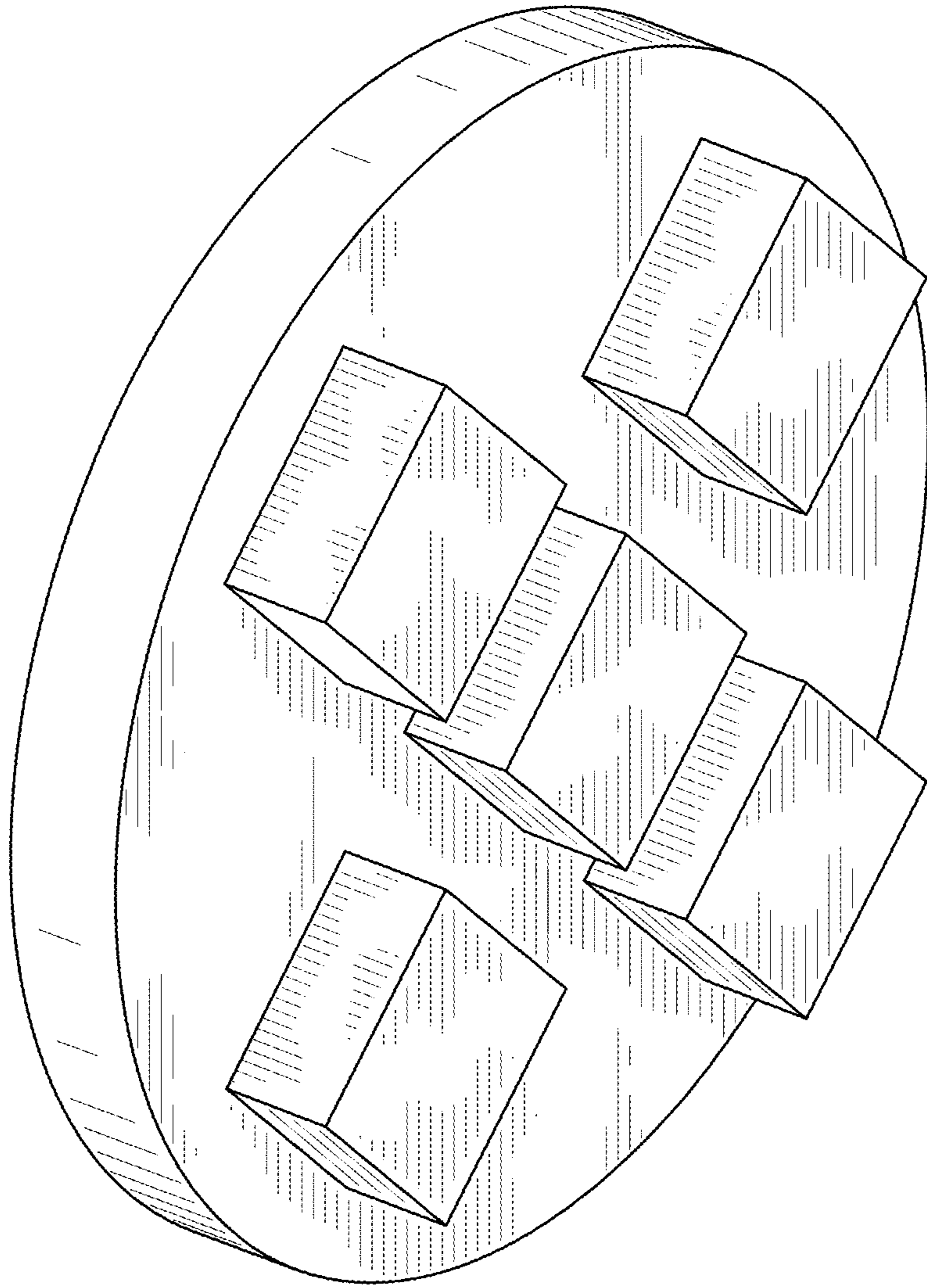

FIG. 13

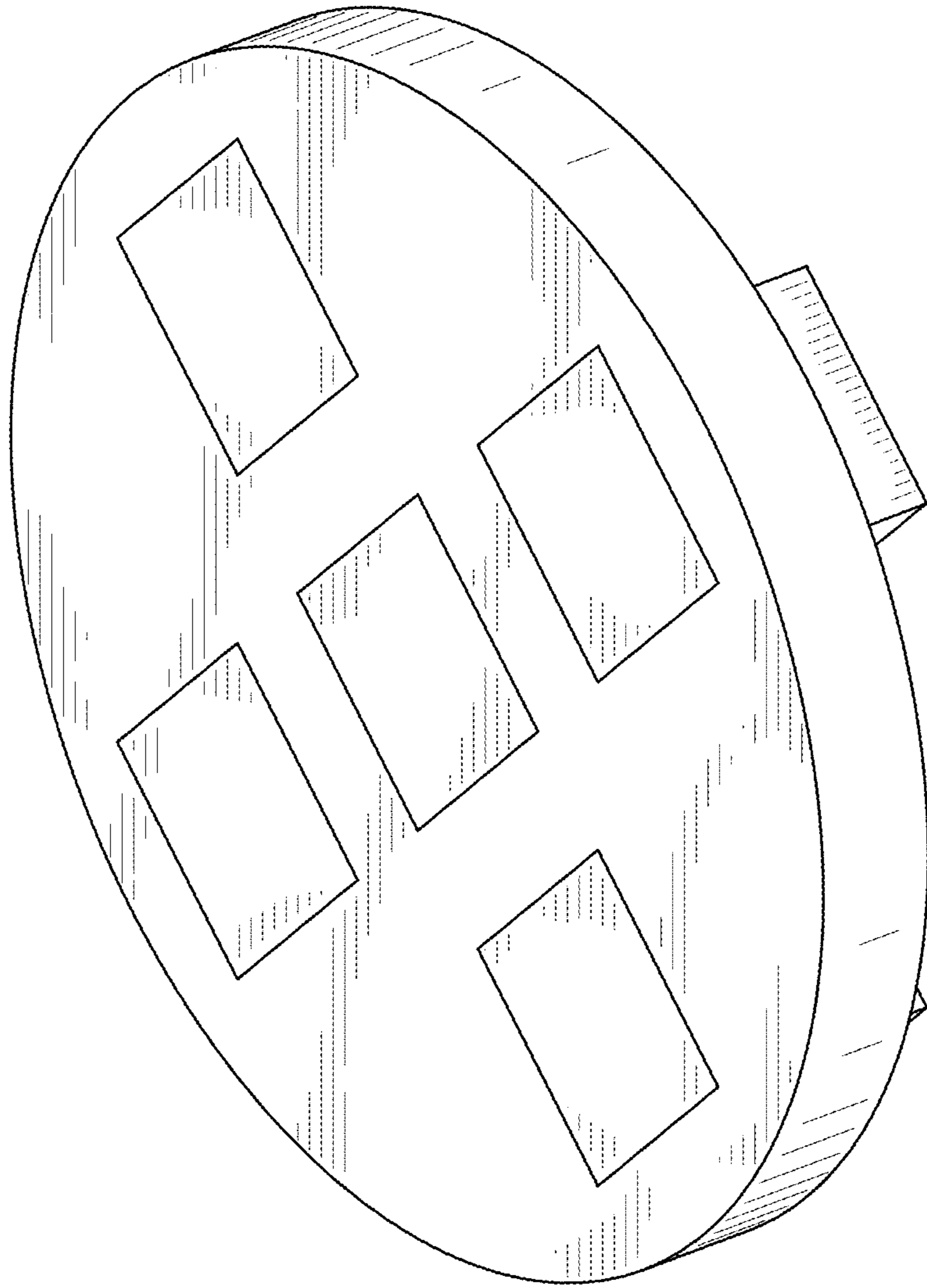

FIG. 14

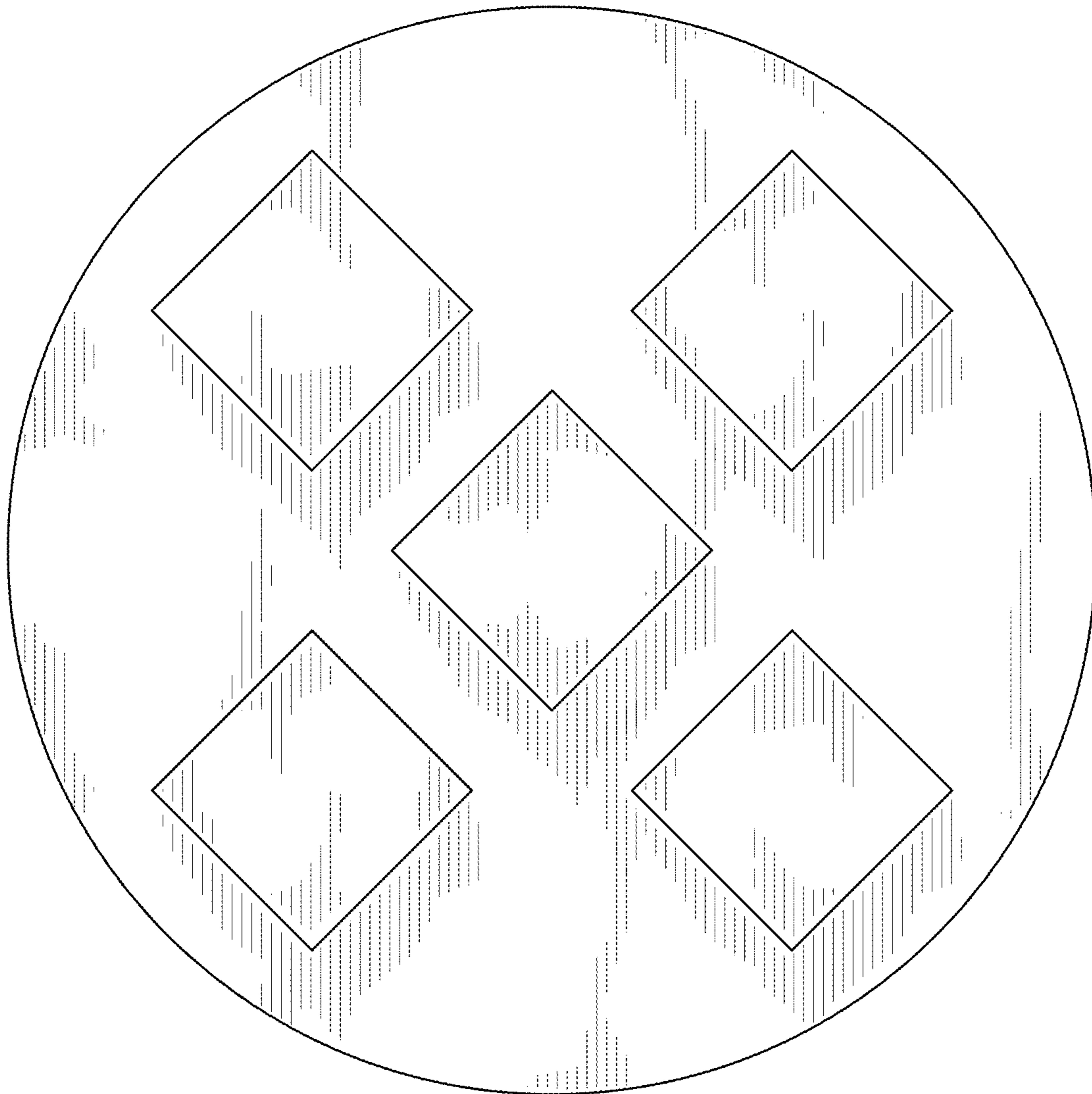

FIG. 15

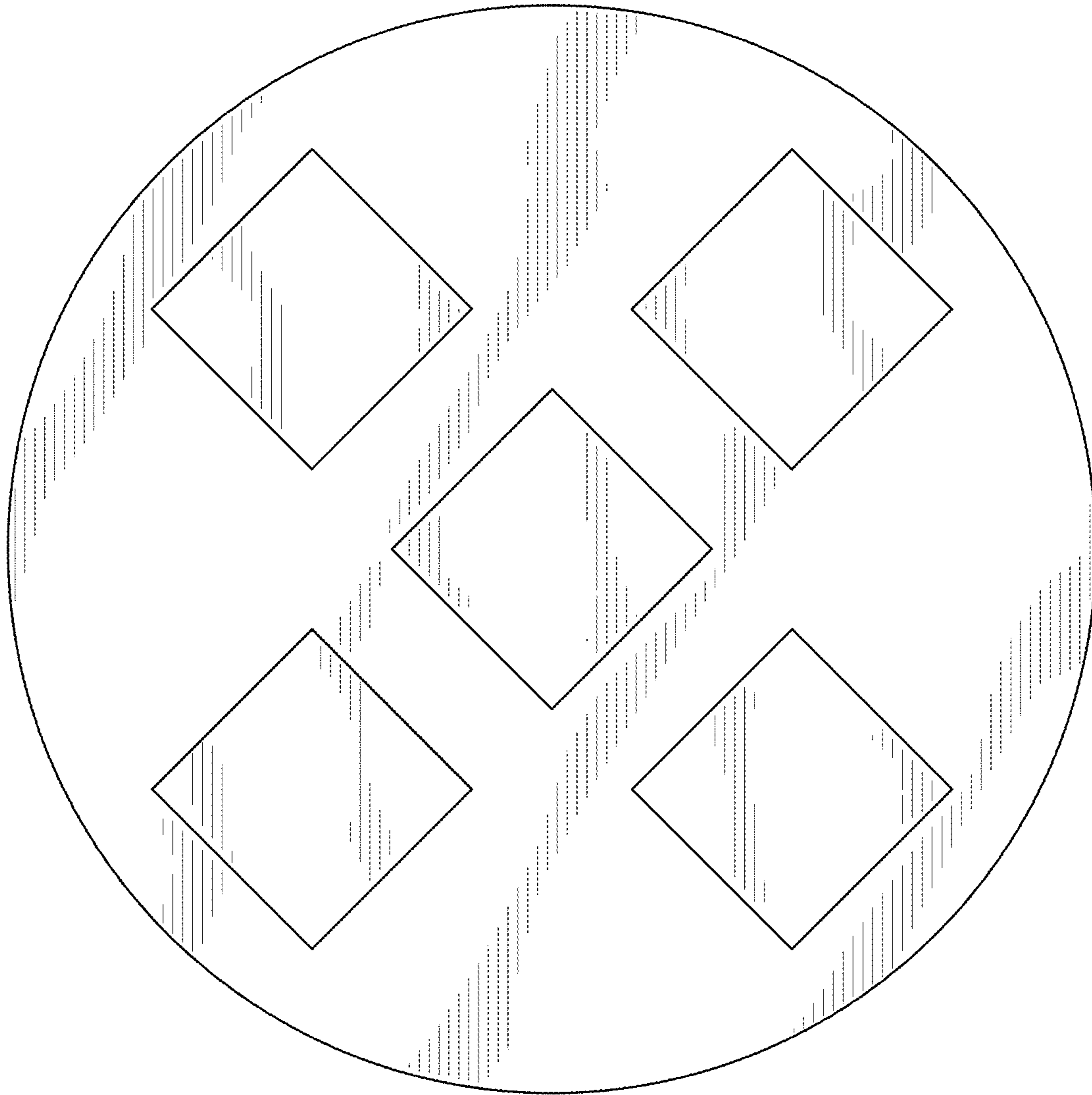

FIG. 16



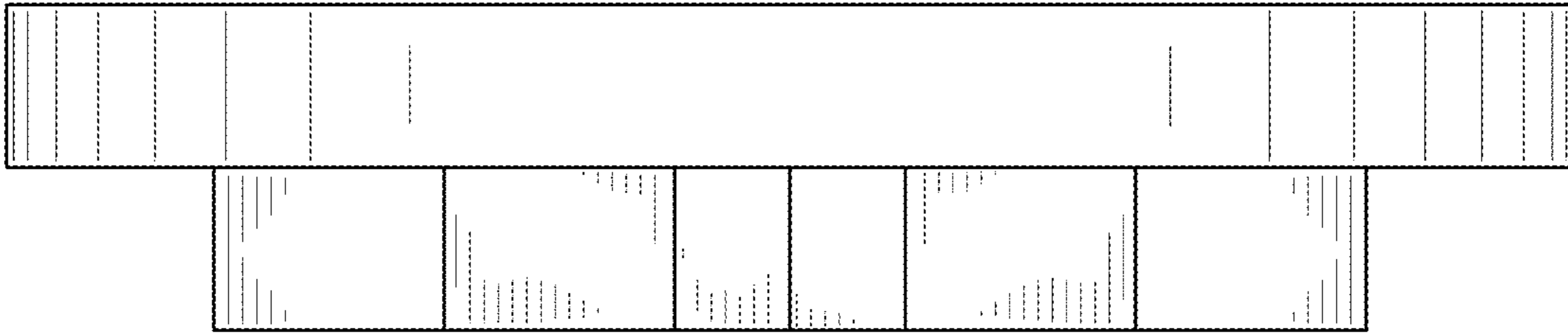

FIG. 17

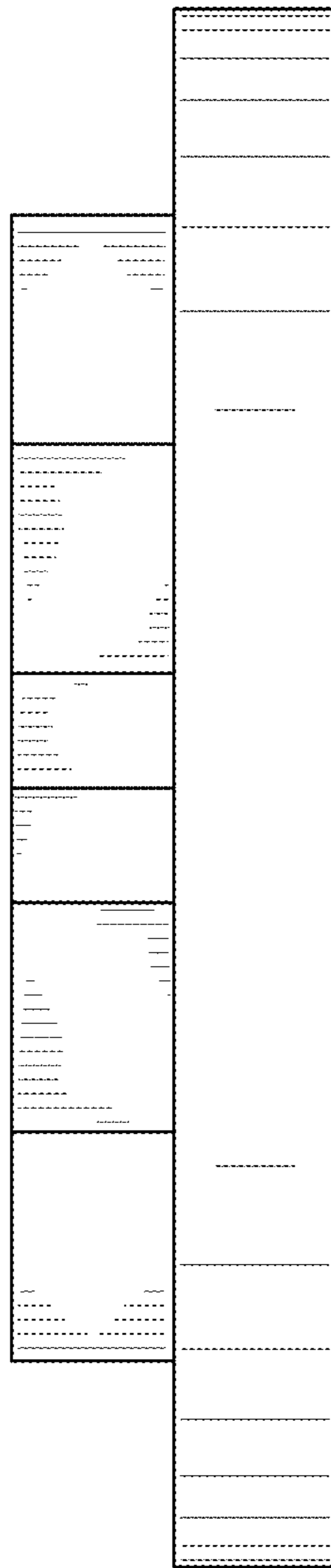

FIG. 18