

US00D868887S

(12) **United States Design Patent** (10) **Patent No.:** **US D868,887 S**  
**Mills et al.** (45) **Date of Patent:** **\*\* Dec. 3, 2019**

(54) **PAYMENT CARD**

(71) Applicant: **Capital One Services, LLC**, McLean, VA (US)

(72) Inventors: **Brian R. Mills**, Richmond, VA (US);  
**Carl Pierce**, Philadelphia, PA (US)

(73) Assignee: **CAPITAL ONE SERVICES, LLC**,  
McLean, VA (US)

(\*\*) Term: **15 Years**

(21) Appl. No.: **29/692,453**

(22) Filed: **May 24, 2019**

**Related U.S. Application Data**

(62) Division of application No. 29/677,787, filed on Jan. 23, 2019, now Pat. No. Des. 857,093, which is a division of application No. 29/596,806, filed on Mar. 10, 2017, now Pat. No. Des. 845,387.

(51) **LOC (12) Cl.** ..... **19-08**

(52) **U.S. Cl.**  
USPC ..... **D19/9**

(58) **Field of Classification Search**  
USPC ..... D19/1-10, 20-34; 40/124.01-124.15, 40/661, 776, 726; 283/72, 75-76, 283/105-107, 82, 70, 904, 74; 206/449; D21/385; D20/10-11, 22, 27, 40, 42; 360/2; 235/380, 382  
CPC .... B42D 15/00; B42D 15/022; B42D 15/027; B42D 15/045; B42D 15/047; B42D 25/00; B42D 25/20; B42D 25/23; B42D 25/26; B42D 25/29; B42D 25/30; B42D 25/40; B42D 25/22; B42D 2033/02; B42D 2033/04; B42D 2033/08; B42D 2033/10; B42D 2033/16; B42D 2033/18; B42D 2033/20; B42D 2033/28; B42D 2033/30

See application file for complete search history.

(56) **References Cited**

U.S. PATENT DOCUMENTS

D466,929 S	12/2002	Haas
D480,754 S	10/2003	Berger
D490,103 S	5/2004	Rangel et al.
D510,384 S	10/2005	Allen et al.
D559,905 S	1/2008	Halbur et al.
D568,388 S	5/2008	Hammad
D569,425 S	5/2008	Law et al.
D571,856 S	6/2008	Hammad et al.
D575,332 S	8/2008	Parker et al.
D599,849 S	9/2009	Halbur et al.
D624,962 S	10/2010	Lazarowicz et al.

(Continued)

*Primary Examiner* — Abraham Bahta

(74) *Attorney, Agent, or Firm* — Finnegan, Henderson, Farabow, Garrett & Dunner LLP

(57) **CLAIM**

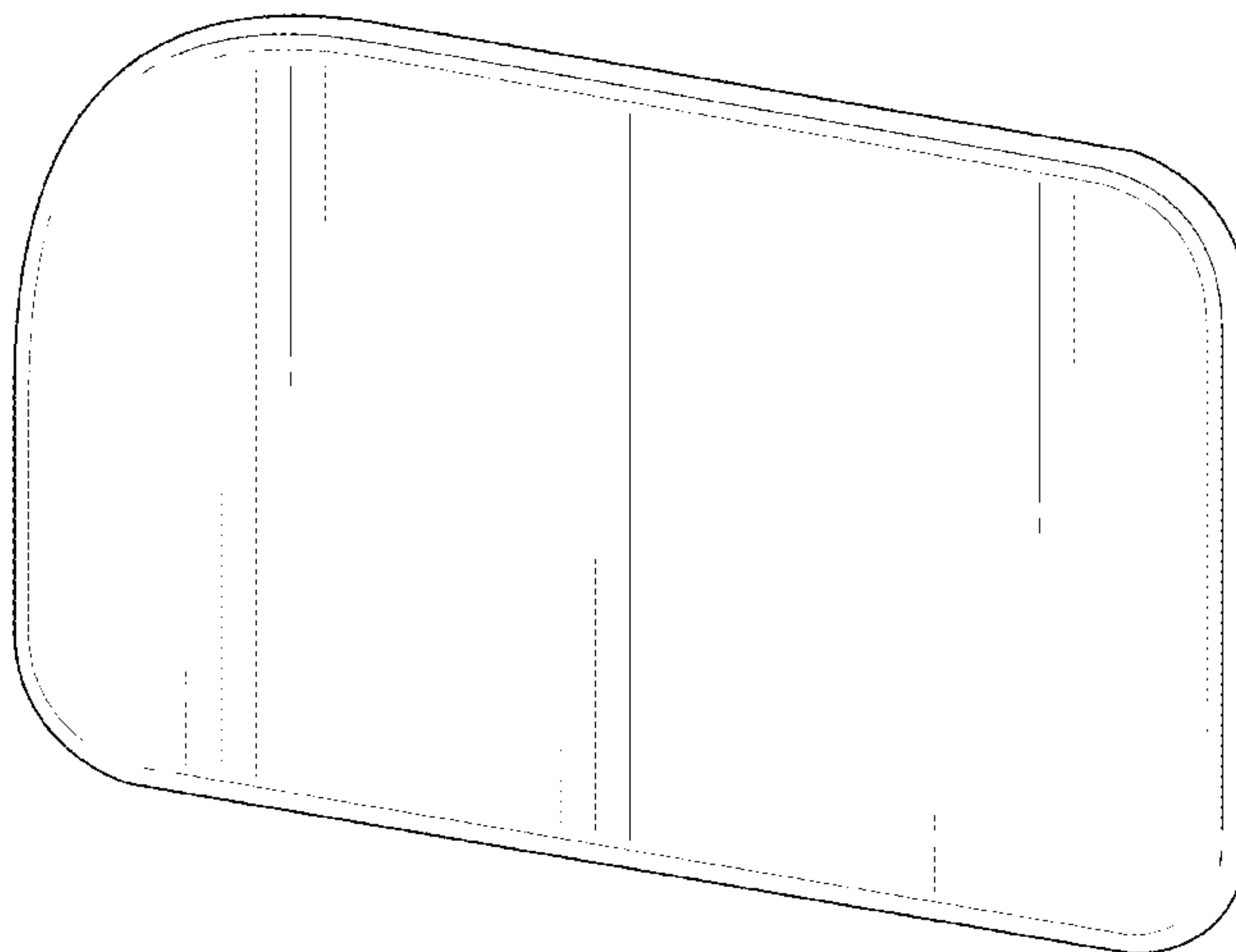
The ornamental design for a payment card, as shown and described.

**DESCRIPTION**

FIG. 1 is a front right perspective view of a payment card showing our new design; FIG. 2 is a rear left perspective view thereof; FIG. 3 is a front elevation view thereof; FIG. 4 is a rear elevation view thereof; FIG. 5 is a top plan view thereof; FIG. 6 is a right side view thereof; FIG. 7 is a left side view thereof; and, FIG. 8 is an enlarged, detailed view of the top view, as shown in FIG. 5.

The shape of the edge of the payment card illustrated in FIG. 8 is consistent around the perimeter of the top, right, left, and bottom sides of the payment card in both embodiments. The broken lines shown in the drawings illustrate portions of the payment card that form no part of the claimed design.

**1 Claim, 8 Drawing Sheets**



(56)

**References Cited**

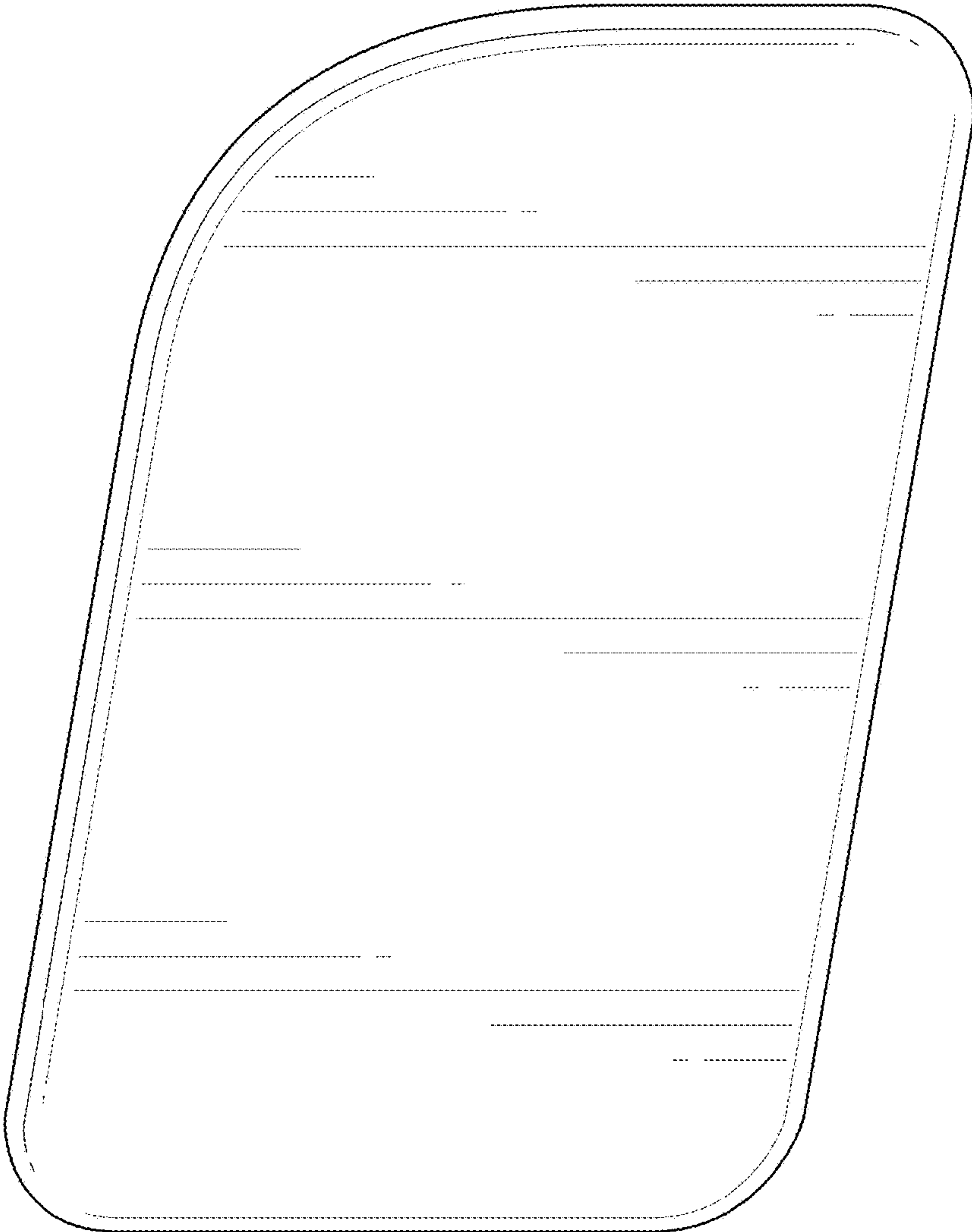
U.S. PATENT DOCUMENTS

D634,780 S	3/2011	Schumann	
D690,767 S	10/2013	Lindley	
D724,660 S	3/2015	Sippola et al.	
D779,591 S	2/2017	Cepress	
D803,313 S	11/2017	Cepress	
D847,256 S	4/2019	Mills et al.	
D857,093 S *	8/2019	Mills .....	D19/9
D858,629 S *	9/2019	Cepress .....	D19/10

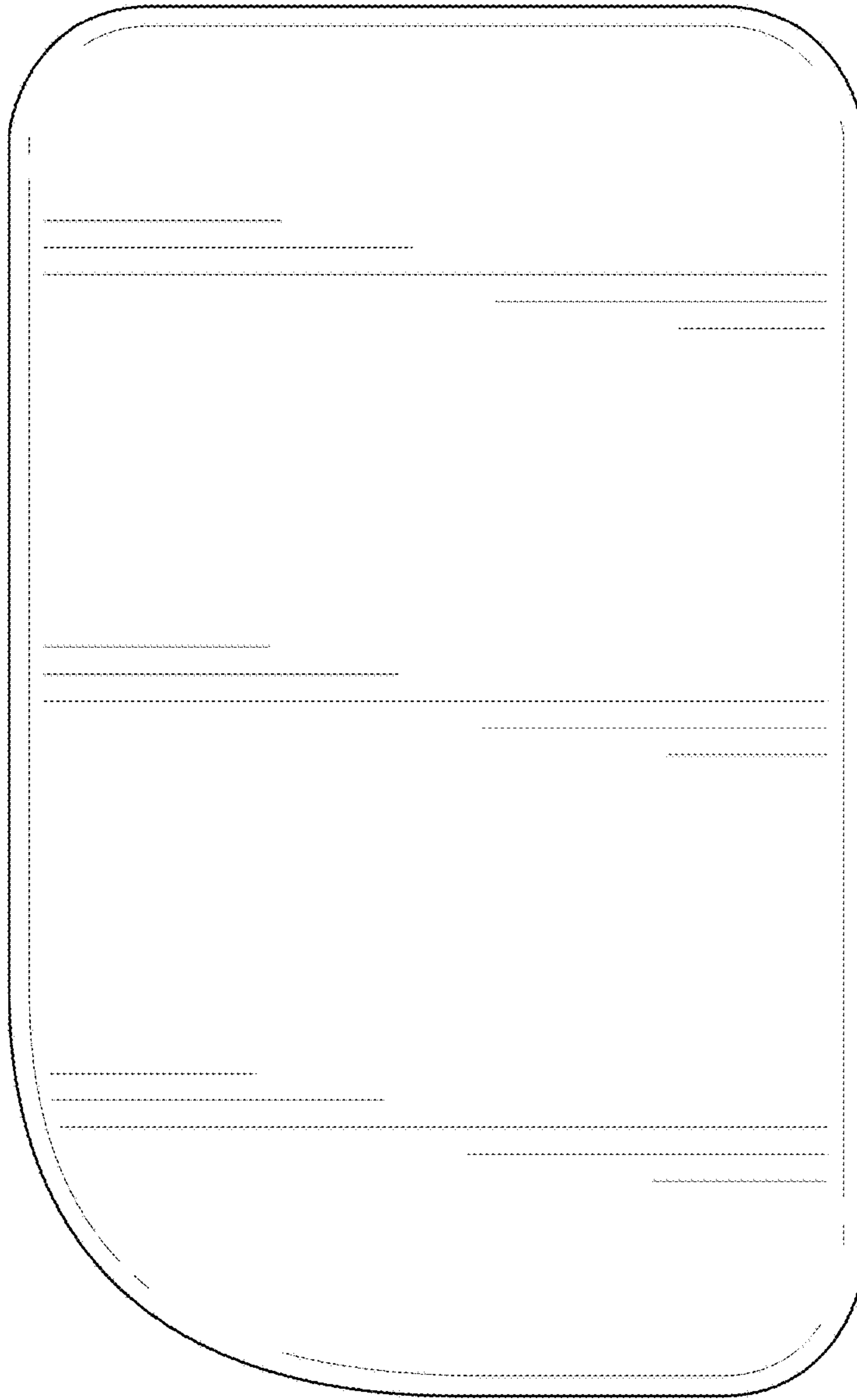
\* cited by examiner



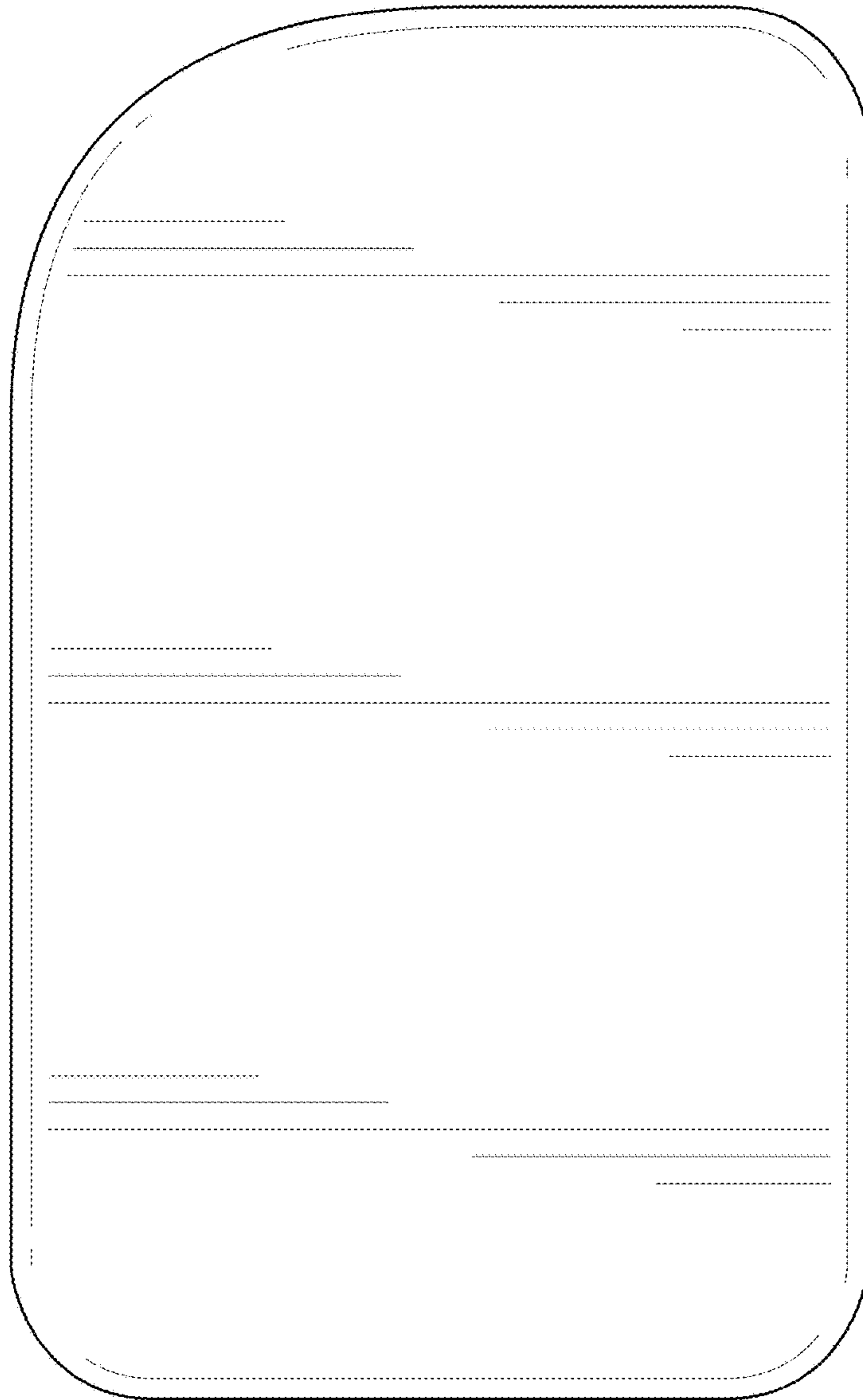
**FIG. 1**



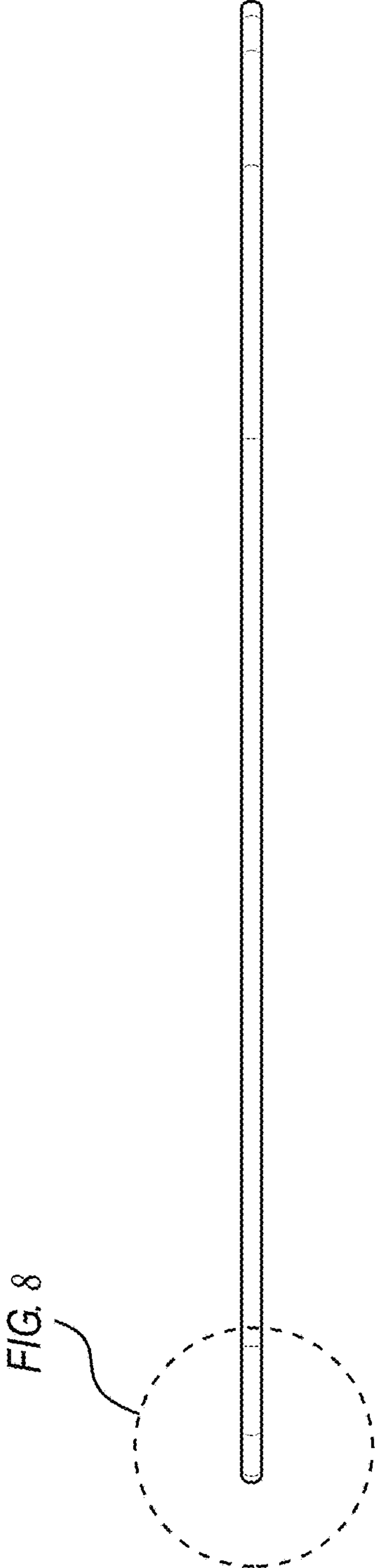
**FIG. 2**



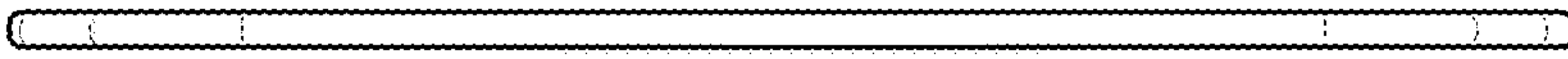
**FIG. 3**



**FIG. 4**

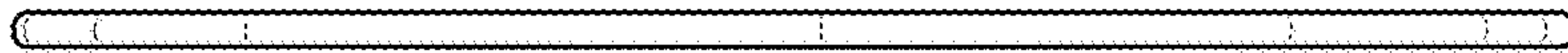


**FIG. 5**

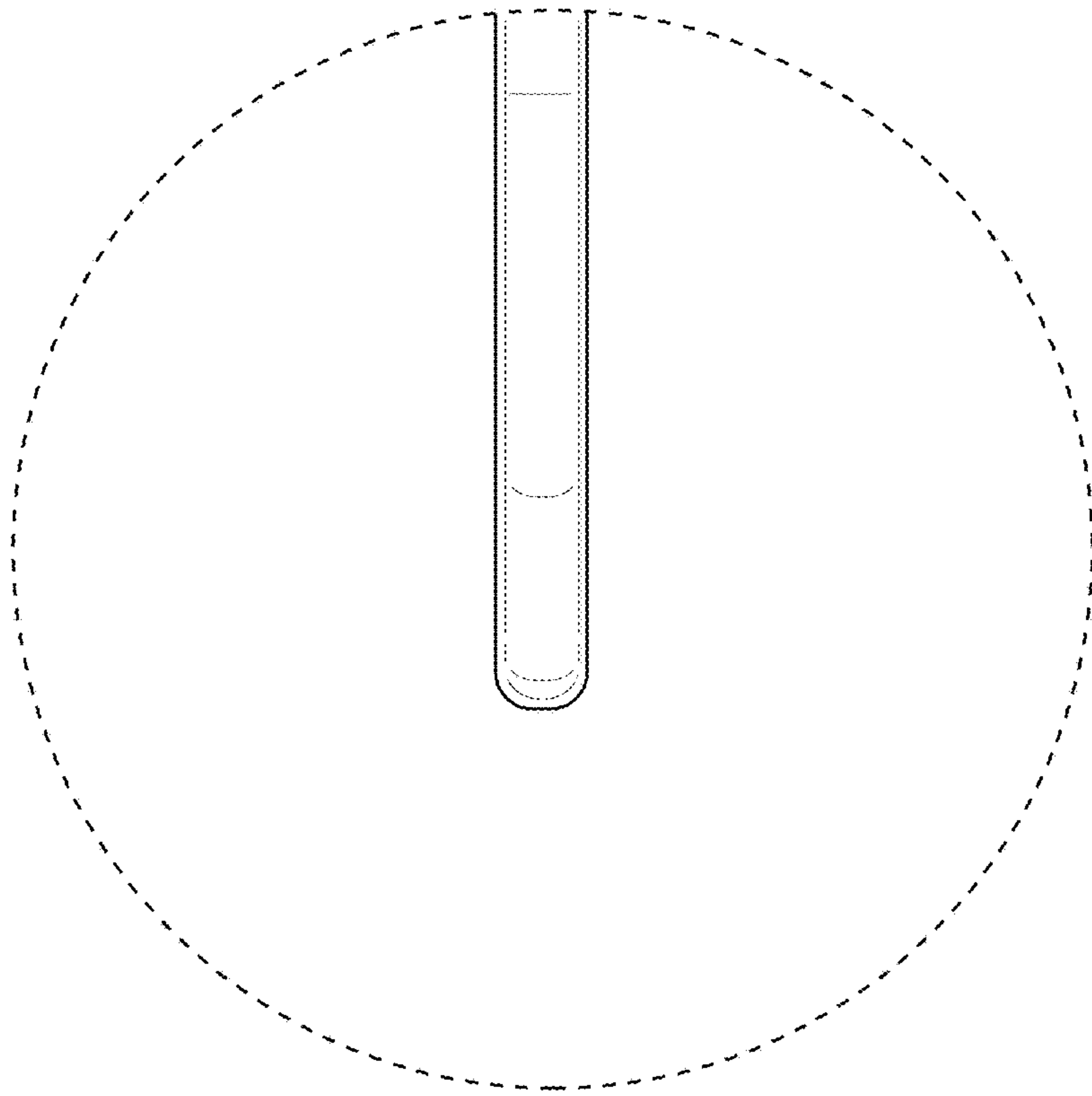


**FIG. 6**





**FIG. 7**



**FIG. 8**