



US00D868851S

(12) **United States Design Patent** (10) **Patent No.:** **US D868,851 S**  
**Lee et al.** (45) **Date of Patent:** **\*\* Dec. 3, 2019**

(54) **DOOR FOR REFRIGERATOR**

(71) Applicant: **Samsung Electronics Co., Ltd.**,  
Suwon-si (KR)

(72) Inventors: **Daekyun Lee**, Suwon-si (KR); **Kisoo Kim**, Gunpo-si (KR); **Seokwoo Kim**, Seoul (KR); **Aeryun Kim**, Ansan-si (KR); **Byeong-Cheol Yoon**, Suwon-si (KR)

(73) Assignee: **Samsung Electronics Co., Ltd.**,  
Suwon-si (KR)

(\*\*) Term: **15 Years**

(21) Appl. No.: **29/634,856**

(22) Filed: **Jan. 25, 2018**

**Related U.S. Application Data**

(62) Division of application No. 29/581,457, filed on Oct. 19, 2016, now Pat. No. Des. 824,965.

(51) **LOC (12) Cl.** ..... **15-07**

(52) **U.S. Cl.**  
USPC ..... **D15/91**

(58) **Field of Classification Search**  
USPC ..... D15/79-91

(Continued)

(56) **References Cited**

**U.S. PATENT DOCUMENTS**

D660,329 S \* 5/2012 Doberstein ..... D15/91  
D760,823 S \* 7/2016 Lee ..... D15/91

(Continued)

*Primary Examiner* — Khawaja Anwar

(74) *Attorney, Agent, or Firm* — NSIP Law

(57) **CLAIM**

We claim the ornamental design for a door for refrigerator, as shown and described.

**DESCRIPTION**

FIG. 1 is a front perspective view of the first embodiment of a door for refrigerator showing our new design;

FIG. 2 is a front view thereof;  
FIG. 3 is a rear view thereof;  
FIG. 4 is a left-side view thereof;  
FIG. 5 is a right-side view thereof;  
FIG. 6 is a top view thereof;  
FIG. 7 is a bottom view thereof;  
FIG. 8 is a front perspective view of the second embodiment of a door for refrigerator showing our new design;  
FIG. 9 is a front view thereof;  
FIG. 10 is a rear view thereof;  
FIG. 11 is a left-side view thereof;  
FIG. 12 is a right-side view thereof;  
FIG. 13 is a top view thereof;  
FIG. 14 is a bottom view thereof;  
FIG. 15 is a front perspective view of the third embodiment of a door for refrigerator showing our new design;  
FIG. 16 is a front view thereof;  
FIG. 17 is a rear view thereof;  
FIG. 18 is a left-side view thereof;  
FIG. 19 is a right-side view thereof;  
FIG. 20 is a top view thereof;  
FIG. 21 is a bottom view thereof;  
FIG. 22 is a front perspective view of the fourth embodiment of a door for refrigerator showing our new design;  
FIG. 23 is a front view thereof;  
FIG. 24 is a rear view thereof;  
FIG. 25 is a left-side view thereof;  
FIG. 26 is a right-side view thereof;  
FIG. 27 is a top view thereof;  
FIG. 28 is a bottom view thereof;  
FIG. 29 is a front perspective view of the fifth embodiment of a door for refrigerator showing our new design;  
FIG. 30 is a front view thereof;  
FIG. 31 is a rear view thereof;  
FIG. 32 is a left-side view thereof;  
FIG. 33 is a right-side view thereof;  
FIG. 34 is a top view thereof;  
FIG. 35 is a bottom view thereof;  
FIG. 36 is a front perspective view of the sixth embodiment of a door for refrigerator showing our new design;  
FIG. 37 is a front view thereof;  
FIG. 38 is a rear view thereof;  
FIG. 39 is a left-side view thereof;

(Continued)

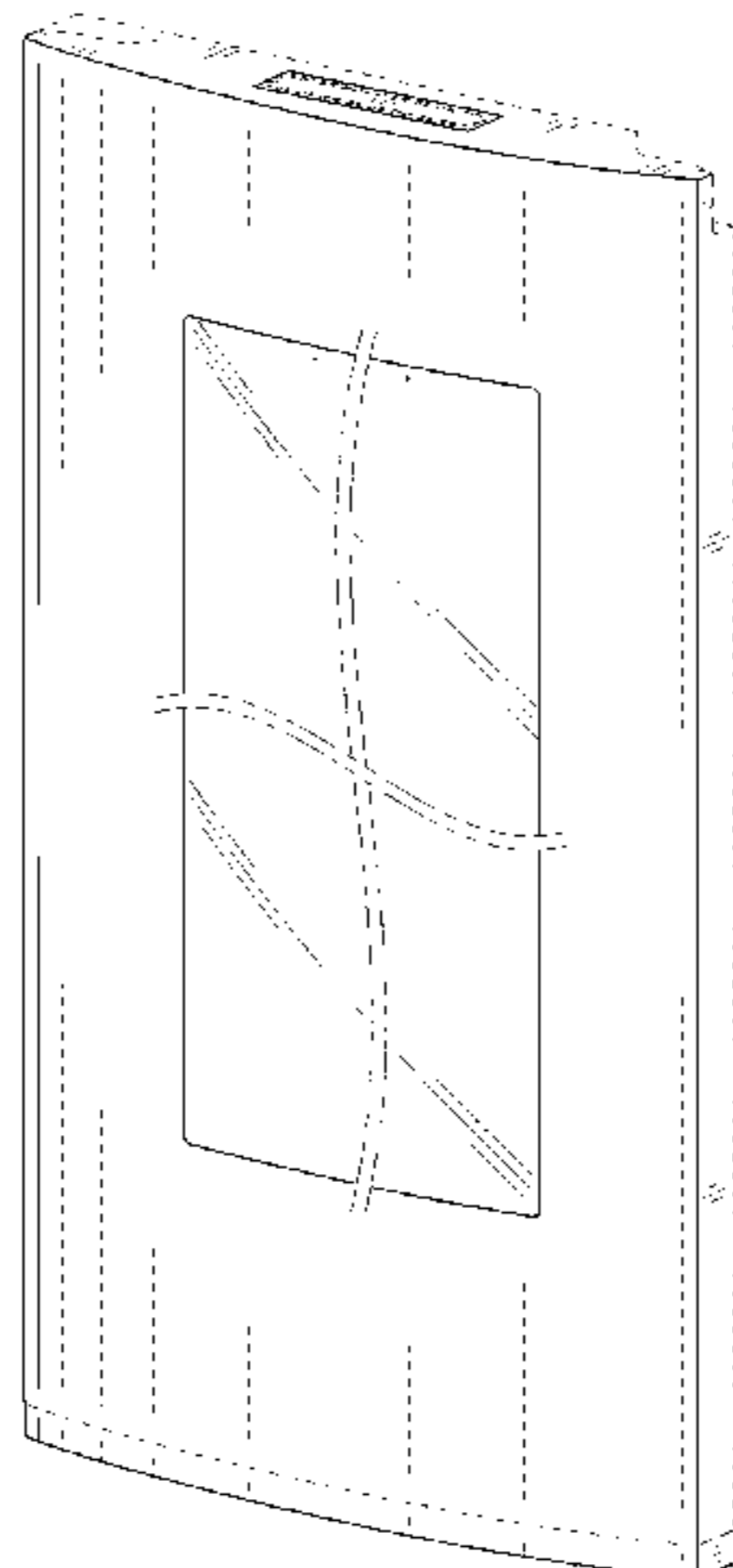

FIG. 40 is a right-side view thereof;  
 FIG. 41 is a top view thereof;  
 FIG. 42 is a bottom view thereof;  
 FIG. 43 is a front perspective view of the seventh embodiment of a door for refrigerator showing our new design;  
 FIG. 44 is a front view thereof;  
 FIG. 45 is a rear view thereof;  
 FIG. 46 is a left-side view thereof;  
 FIG. 47 is a right-side view thereof;  
 FIG. 48 is a top view thereof;  
 FIG. 49 is a bottom view thereof;  
 FIG. 50 is a front perspective view of the eighth embodiment of a door for refrigerator showing our new design;  
 FIG. 51 is a front view thereof;  
 FIG. 52 is a rear view thereof;  
 FIG. 53 is a left-side view thereof;  
 FIG. 54 is a right-side view thereof;  
 FIG. 55 is a top view thereof;  
 FIG. 56 is a bottom view thereof;  
 FIG. 57 is a front perspective view of the ninth embodiment of a door for refrigerator showing our new design;  
 FIG. 58 is a front view thereof;  
 FIG. 59 is a rear view thereof;  
 FIG. 60 is a left-side view thereof;  
 FIG. 61 is a right-side view thereof;  
 FIG. 62 is a top view thereof;  
 FIG. 63 is a bottom view thereof;  
 FIG. 64 is a front perspective view of the tenth embodiment of a door for refrigerator showing our new design;  
 FIG. 65 is a front view thereof;  
 FIG. 66 is a rear view thereof;  
 FIG. 67 is a left-side view thereof;  
 FIG. 68 is a right-side view thereof;  
 FIG. 69 is a top view thereof;  
 FIG. 70 is a bottom view thereof;  
 FIG. 71 is a front perspective view of the eleventh embodiment of a door for refrigerator showing our new design;  
 FIG. 72 is a front view thereof;  
 FIG. 73 is a rear view thereof;  
 FIG. 74 is a left-side view thereof;  
 FIG. 75 is a right-side view thereof;  
 FIG. 76 is a top view thereof;  
 FIG. 77 is a bottom view thereof;  
 FIG. 78 is a front perspective view of the twelfth embodiment of a door for refrigerator showing our new design;  
 FIG. 79 is a front view thereof;  
 FIG. 80 is a rear view thereof;  
 FIG. 81 is a left-side view thereof;  
 FIG. 82 is a right-side view thereof;  
 FIG. 83 is a top view thereof;  
 FIG. 84 is a bottom view thereof;

FIG. 85 is a front perspective view of the thirteenth embodiment of a door for refrigerator showing our new design;  
 FIG. 86 is a front view thereof;  
 FIG. 87 is a rear view thereof;  
 FIG. 88 is a left-side view thereof;  
 FIG. 89 is a right-side view thereof;  
 FIG. 90 is a top view thereof;  
 FIG. 91 is a bottom view thereof;  
 FIG. 92 is a front perspective view of the fourteenth embodiment of a door for refrigerator showing our new design;  
 FIG. 93 is a front view thereof;  
 FIG. 94 is a rear view thereof;  
 FIG. 95 is a left-side view thereof;  
 FIG. 96 is a right-side view thereof;  
 FIG. 97 is a top view thereof; and,  
 FIG. 98 is a bottom view thereof.

The broken lines in the figures depict portions of the door for refrigerator that form no part of the claimed design.

The pairs of closely adjacent wave dot-dot dash lines form no part of the claimed design and the portion between such pairs of wave lines are broken away to disclose indeterminate length.

**1 Claim, 98 Drawing Sheets**

(58) **Field of Classification Search**

CPC .. F25D 11/00; F25D 17/065; F25D 2325/022;  
 F25D 23/069; F25D 25/025; F25D 11/02;  
 F25D 17/062; F25D 21/12; F25D 21/125;  
 F25D 21/14; F25D 2317/061; F25D  
 2317/067; F25D 2323/021; F25D  
 2323/024; F25D 23/028; F25D 23/04;  
 F25D 23/066; F25D 23/085; F25D  
 23/087; F25D 23/126; F25D 2400/02;  
 F25D 2400/06; F25D 2400/361; F25D  
 2400/40; F25D 25/005; F25D 25/02;  
 F25D 2600/02; F25D 2700/02; F25D  
 2700/12; F25D 2700/121; F25D 2700/14;  
 F25D 29/00

See application file for complete search history.

(56) **References Cited**

U.S. PATENT DOCUMENTS

D768,738	S	*	10/2016	Lee	.....	D15/91
D768,739	S	*	10/2016	Lee	.....	D15/91
D769,948	S	*	10/2016	Lee	.....	D15/91
D783,691	S	*	4/2017	Kim	.....	D15/91
D787,571	S	*	5/2017	Seo	.....	D15/91
D787,572	S	*	5/2017	Seo	.....	D15/91
D807,408	S	*	1/2018	Kim	.....	D15/81

\* cited by examiner

FIG. 1

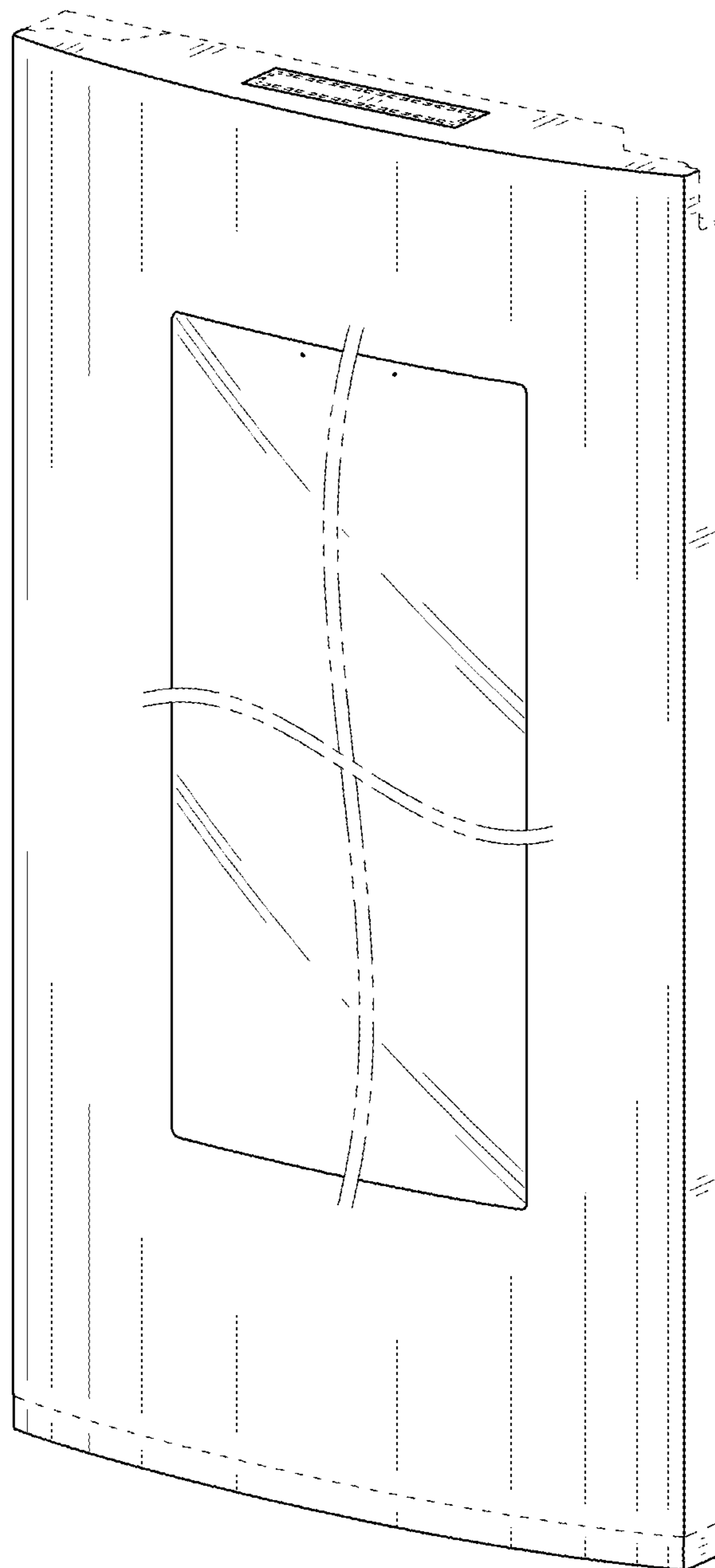



FIG. 2

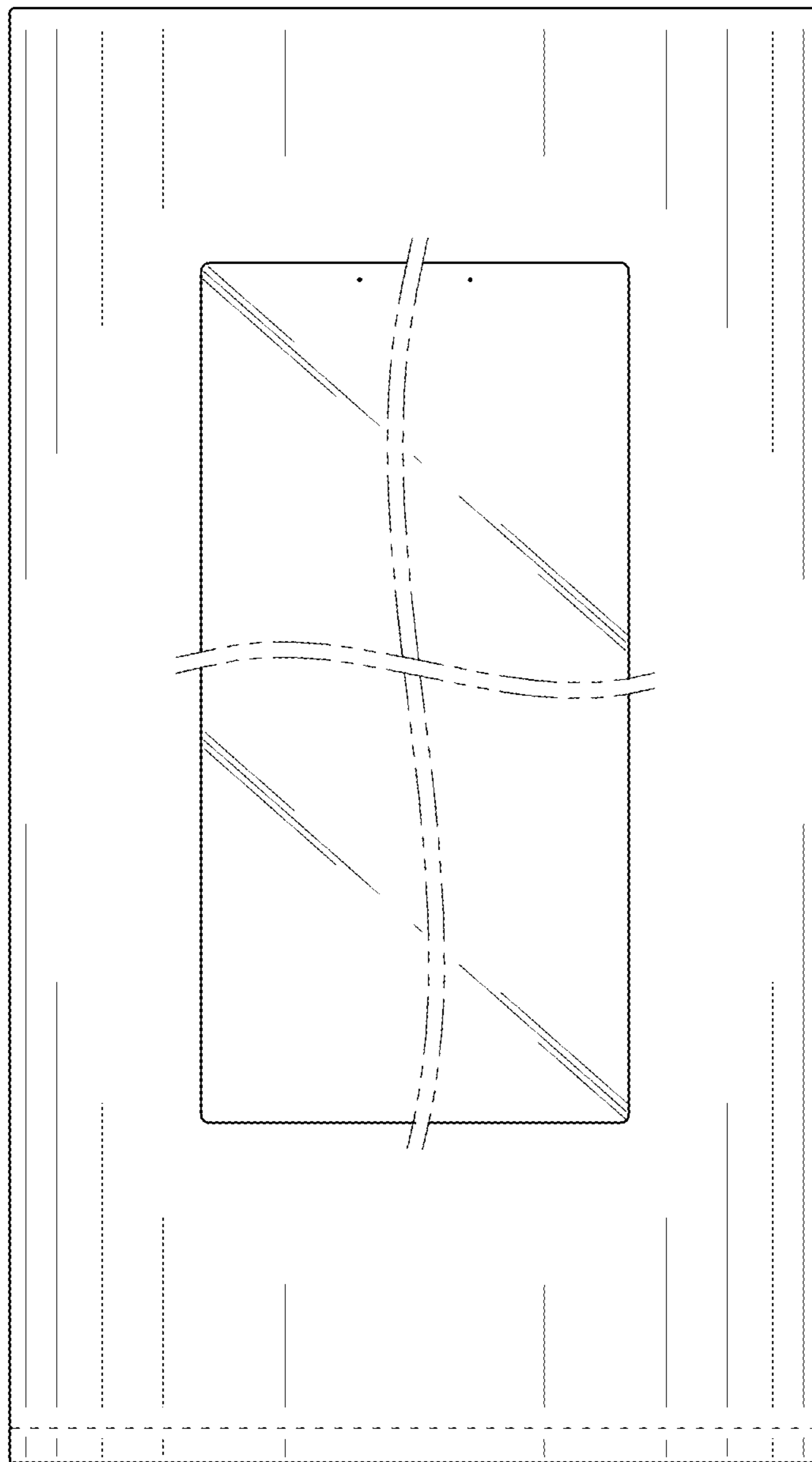

FIG. 3



FIG. 4

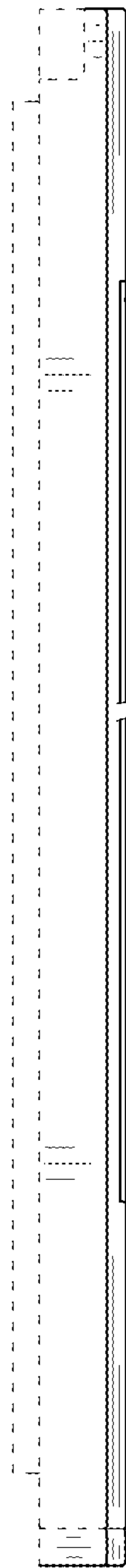

FIG. 5

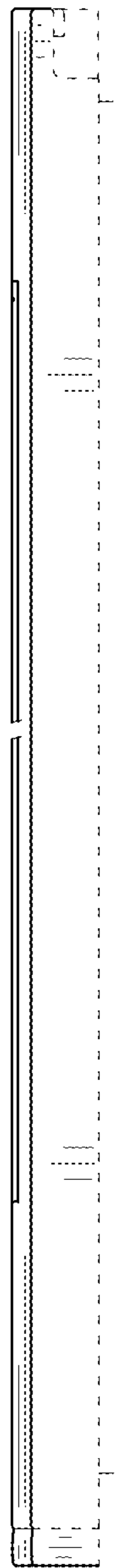

FIG. 6

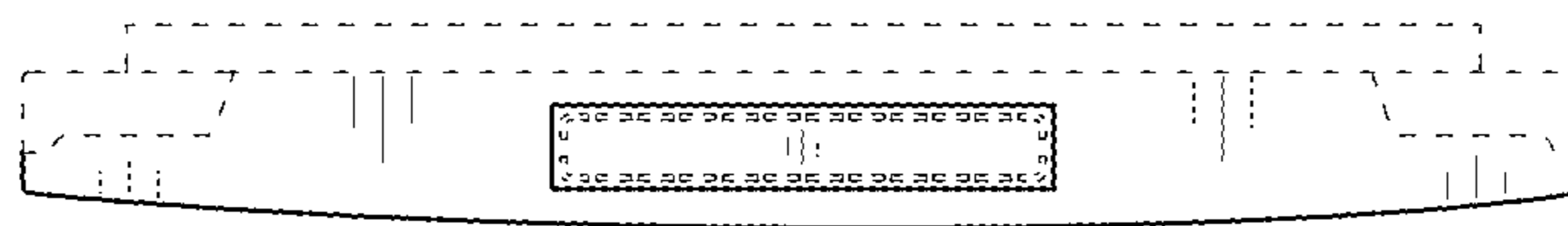



FIG. 7

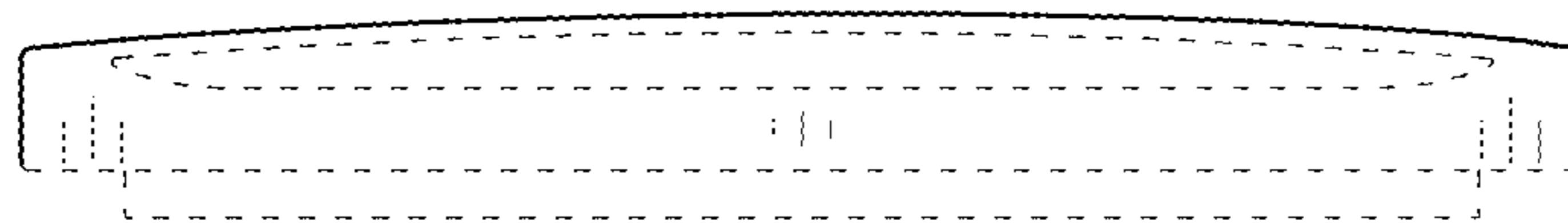

FIG. 8

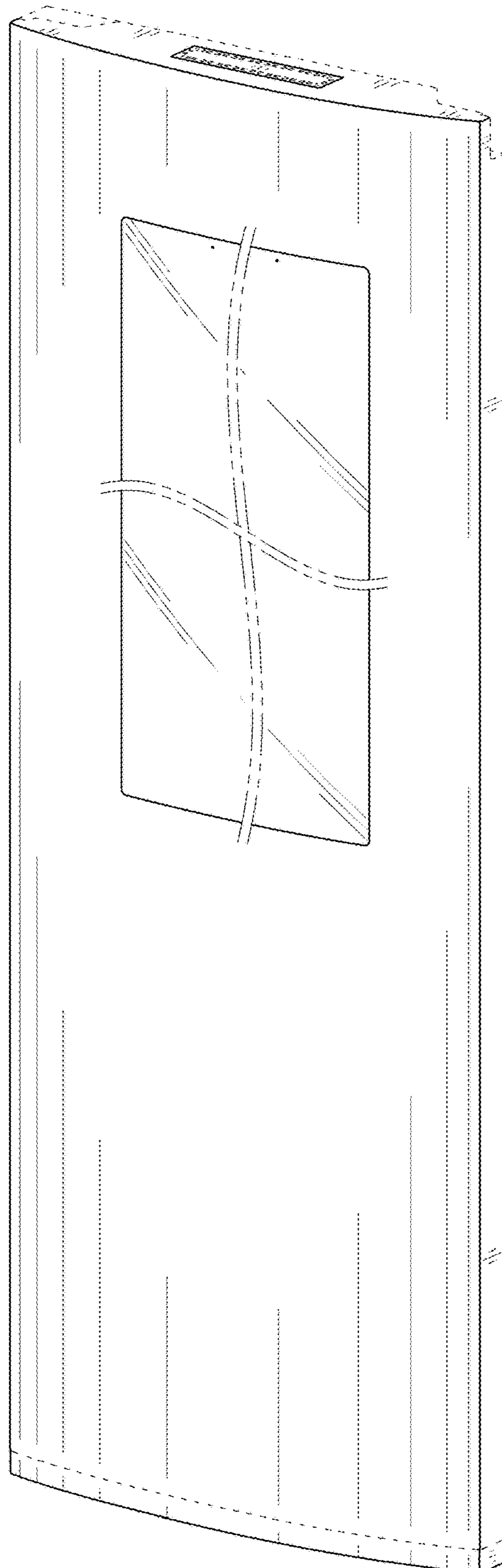

FIG. 9

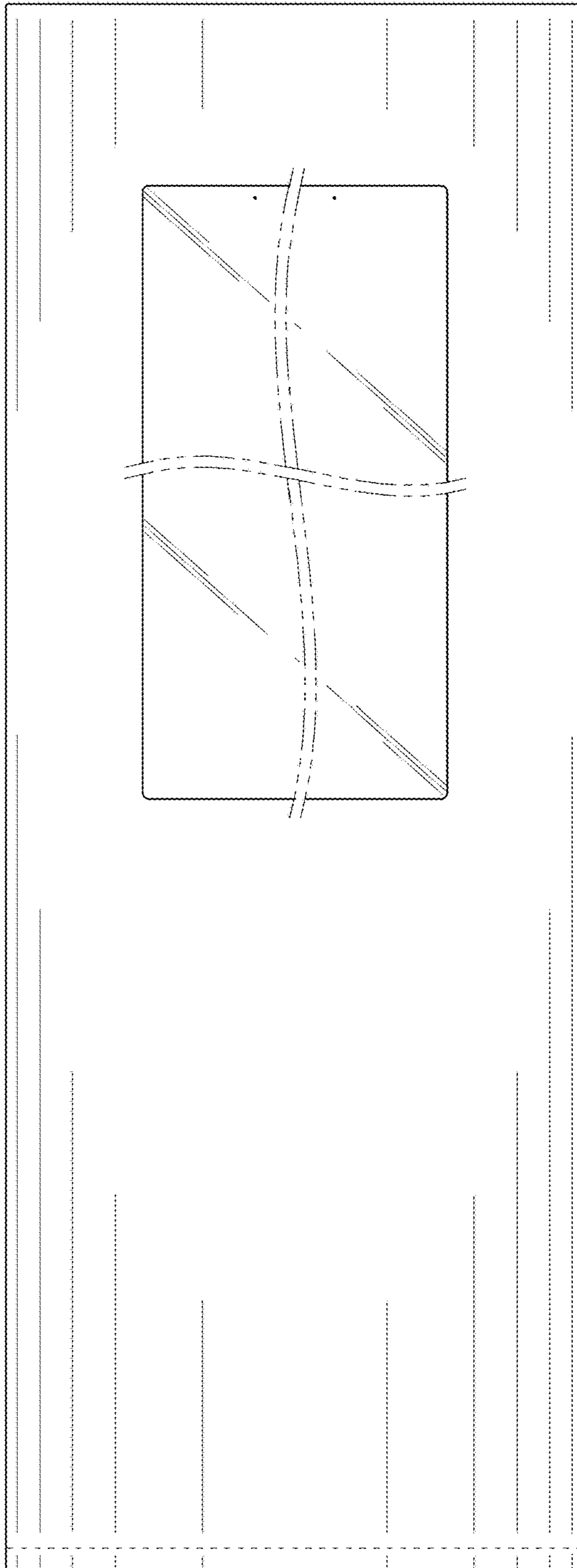

FIG. 10



FIG. 11

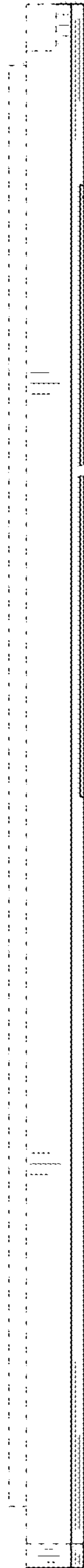

FIG. 12

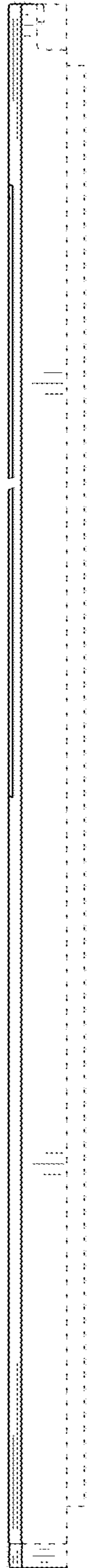



FIG. 13

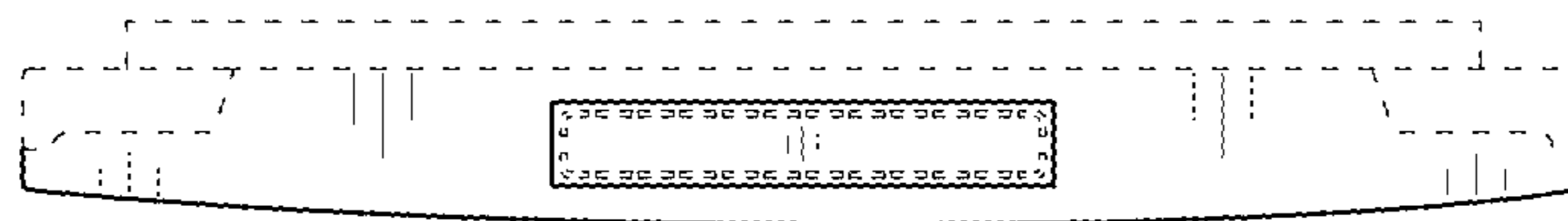

FIG. 14

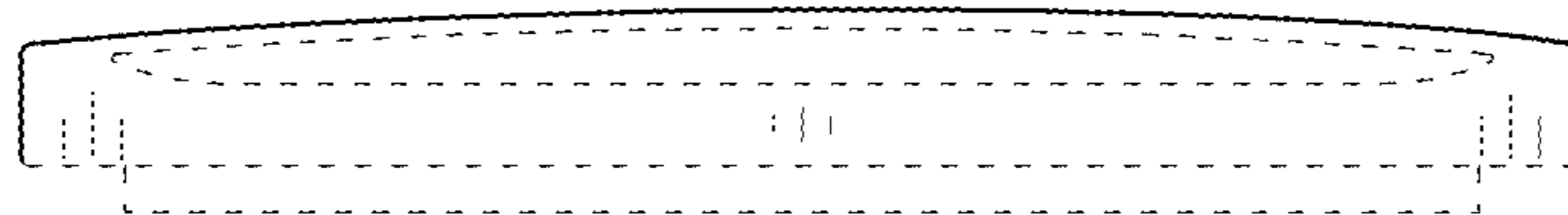

FIG. 15

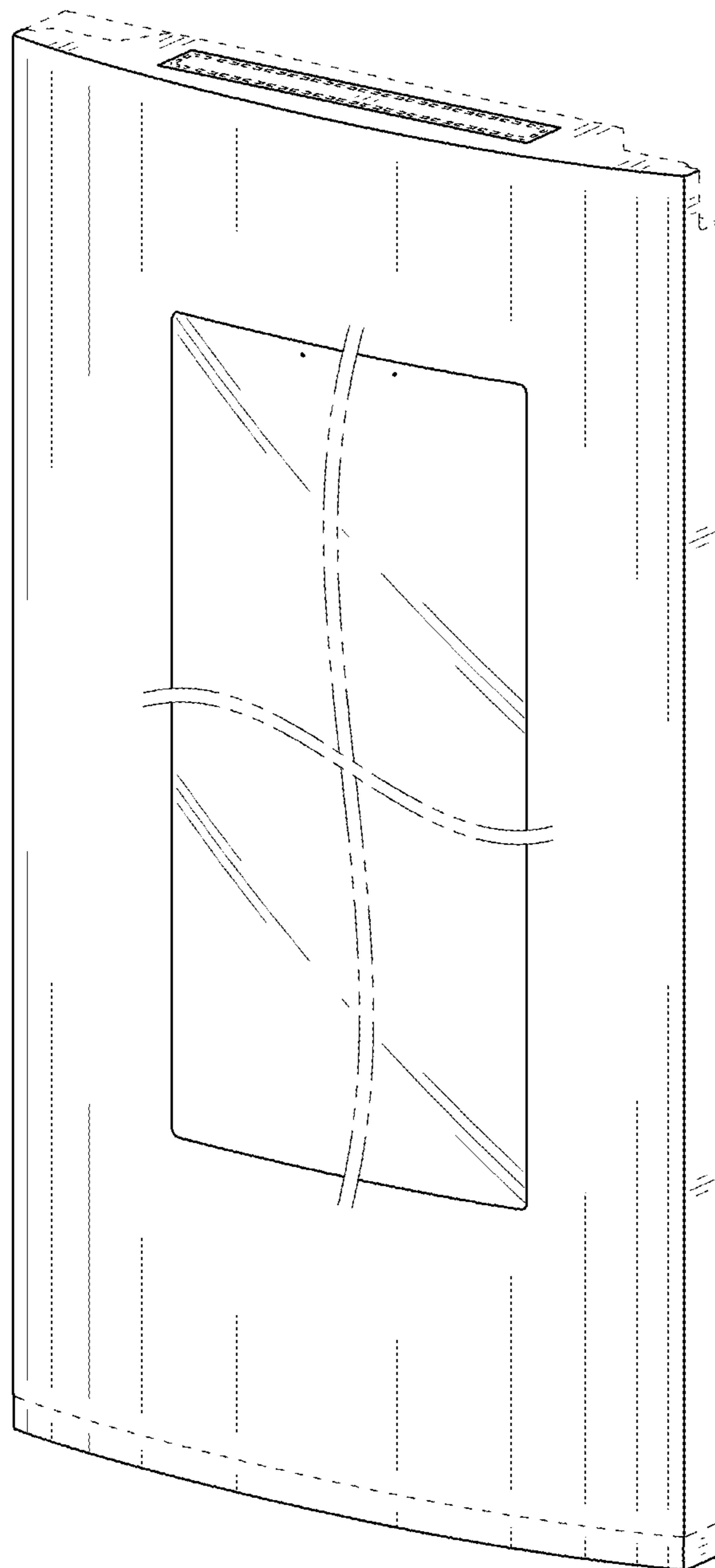

FIG. 16

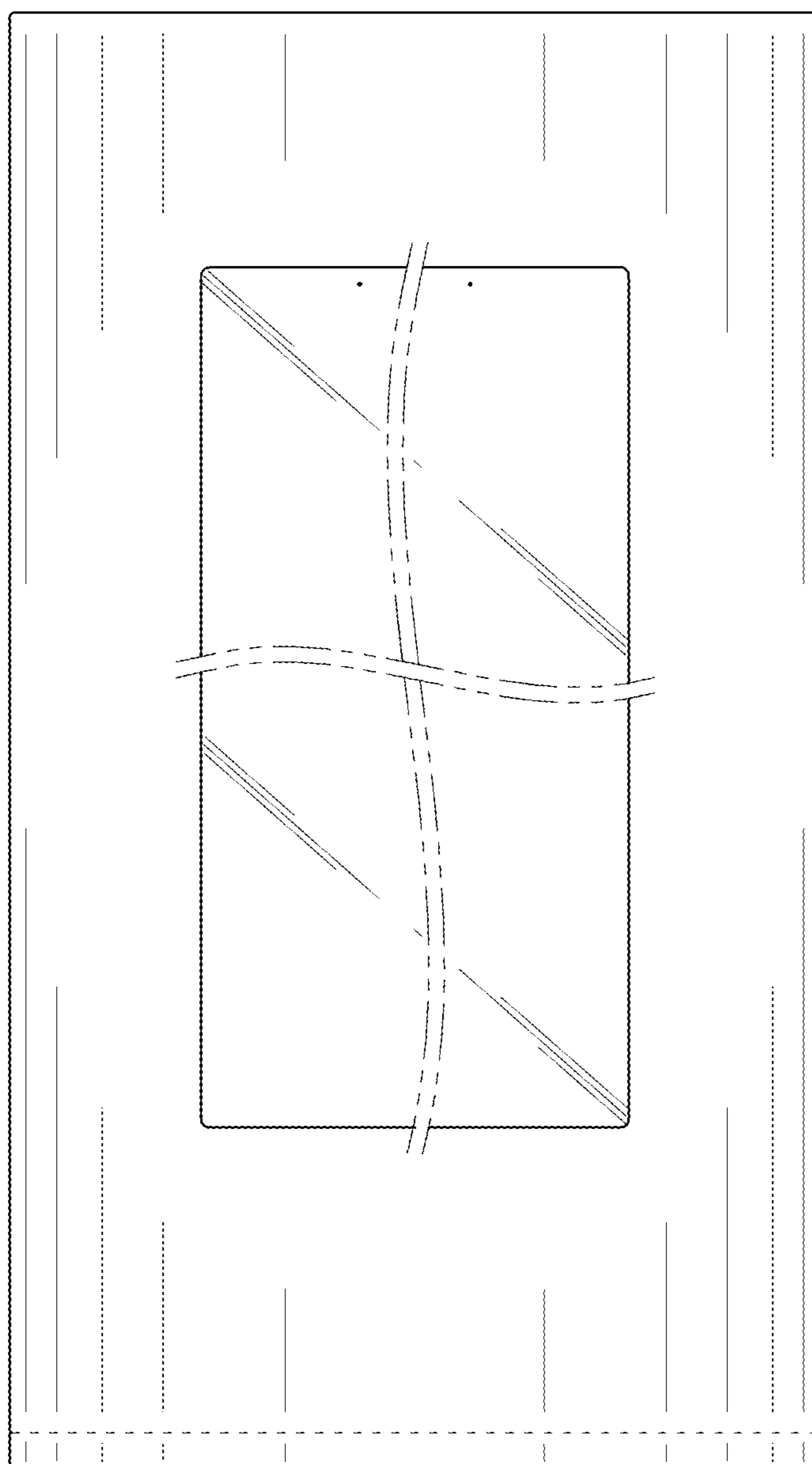

FIG. 17



FIG. 18

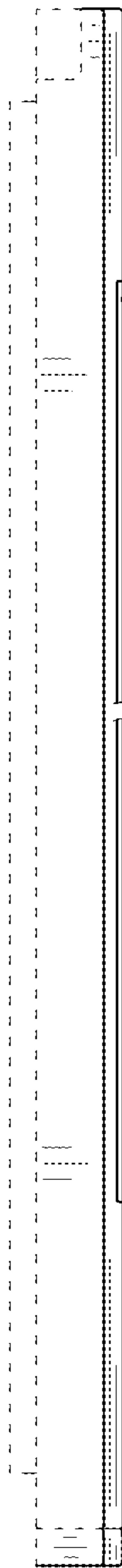



FIG. 19

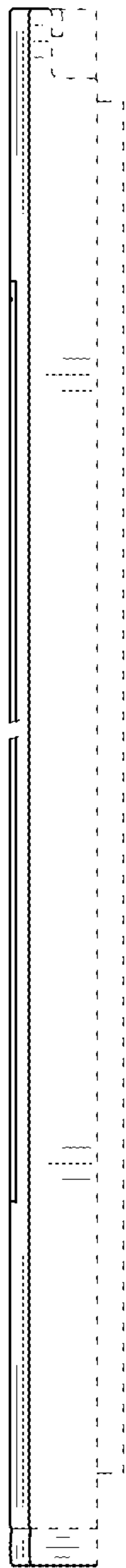

FIG. 20



FIG. 21

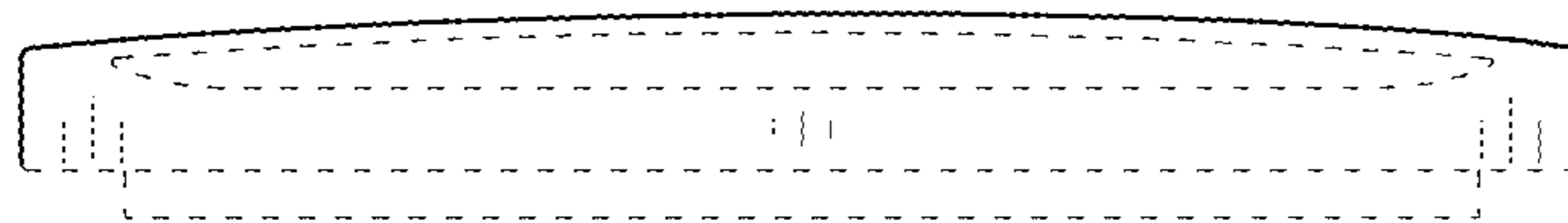

FIG. 22

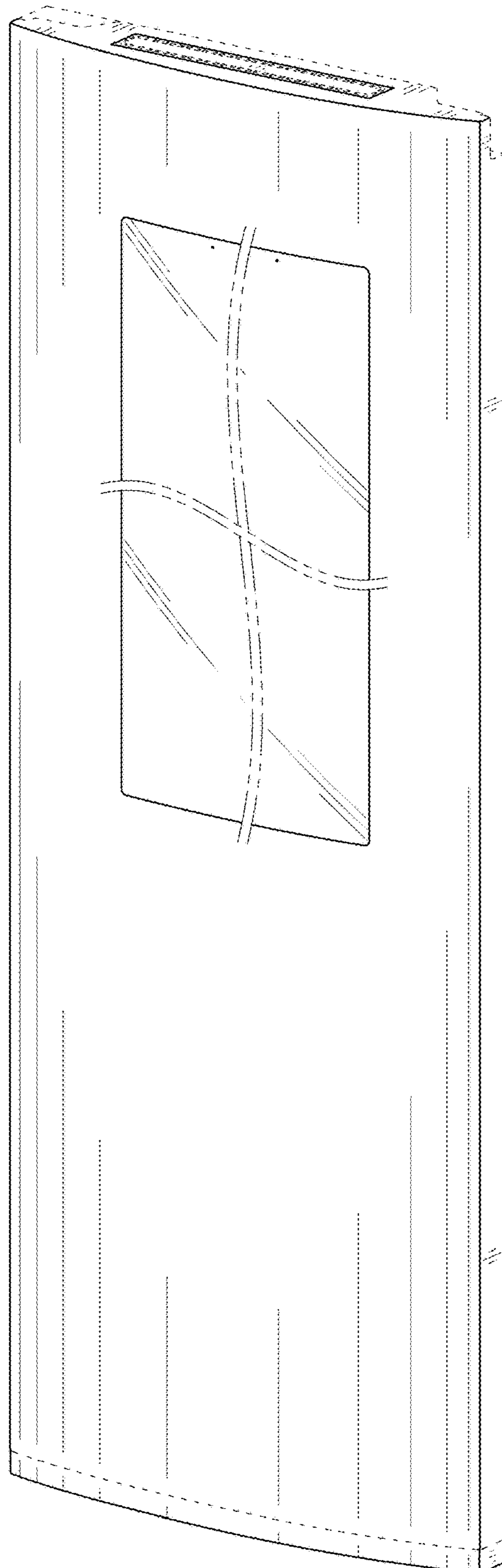

FIG. 23

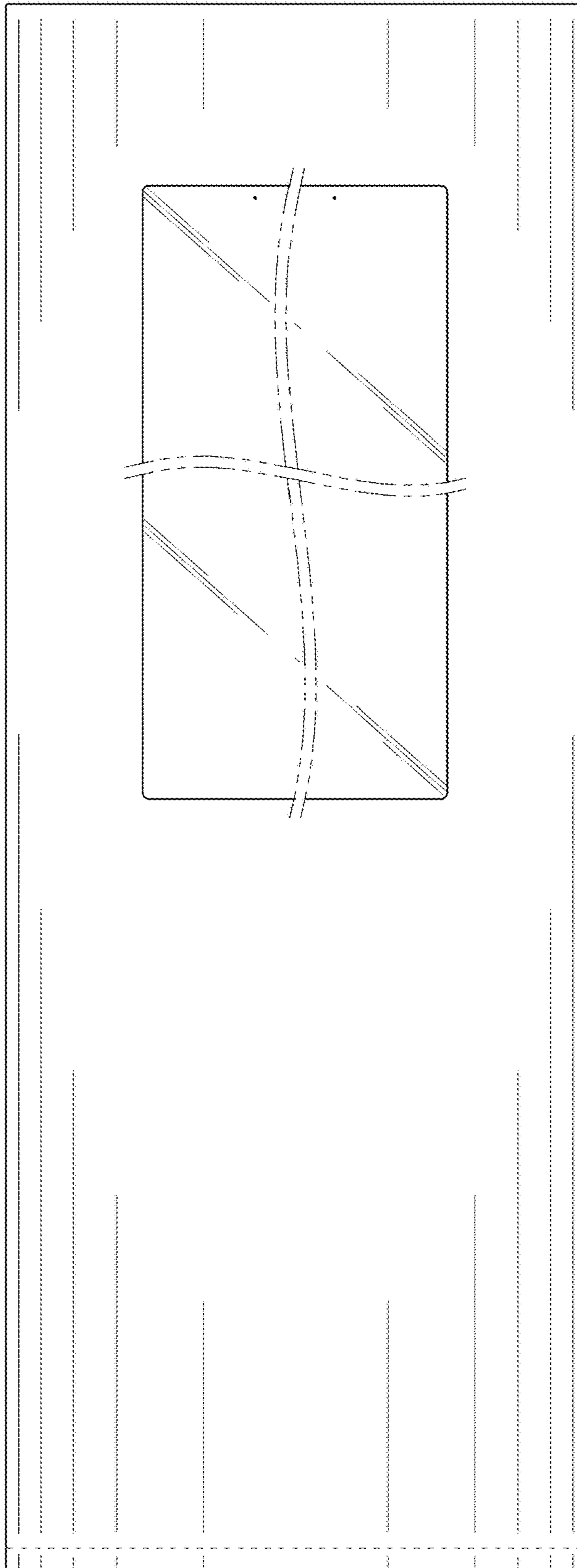

FIG. 24





FIG. 25

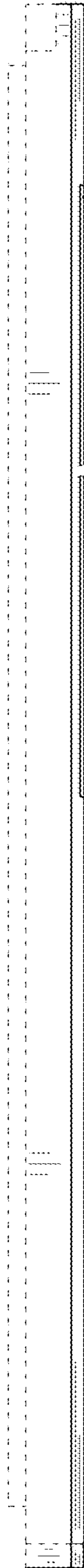

FIG. 26

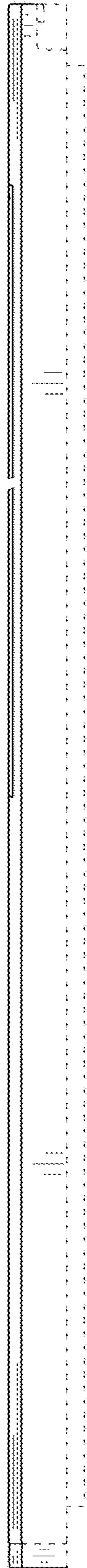

FIG. 27

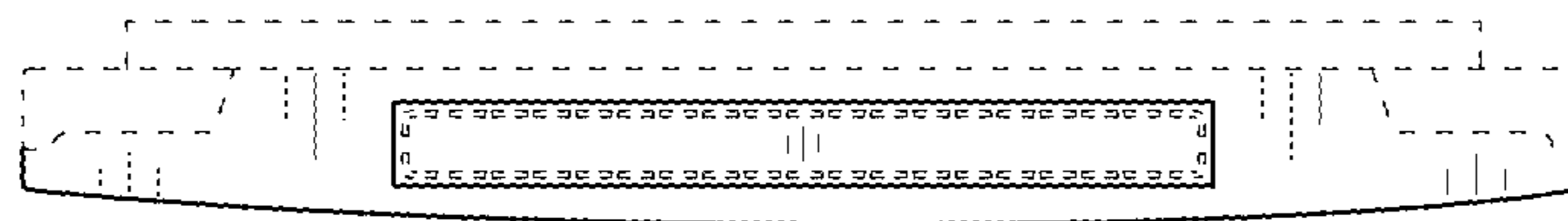

FIG. 28



FIG. 29

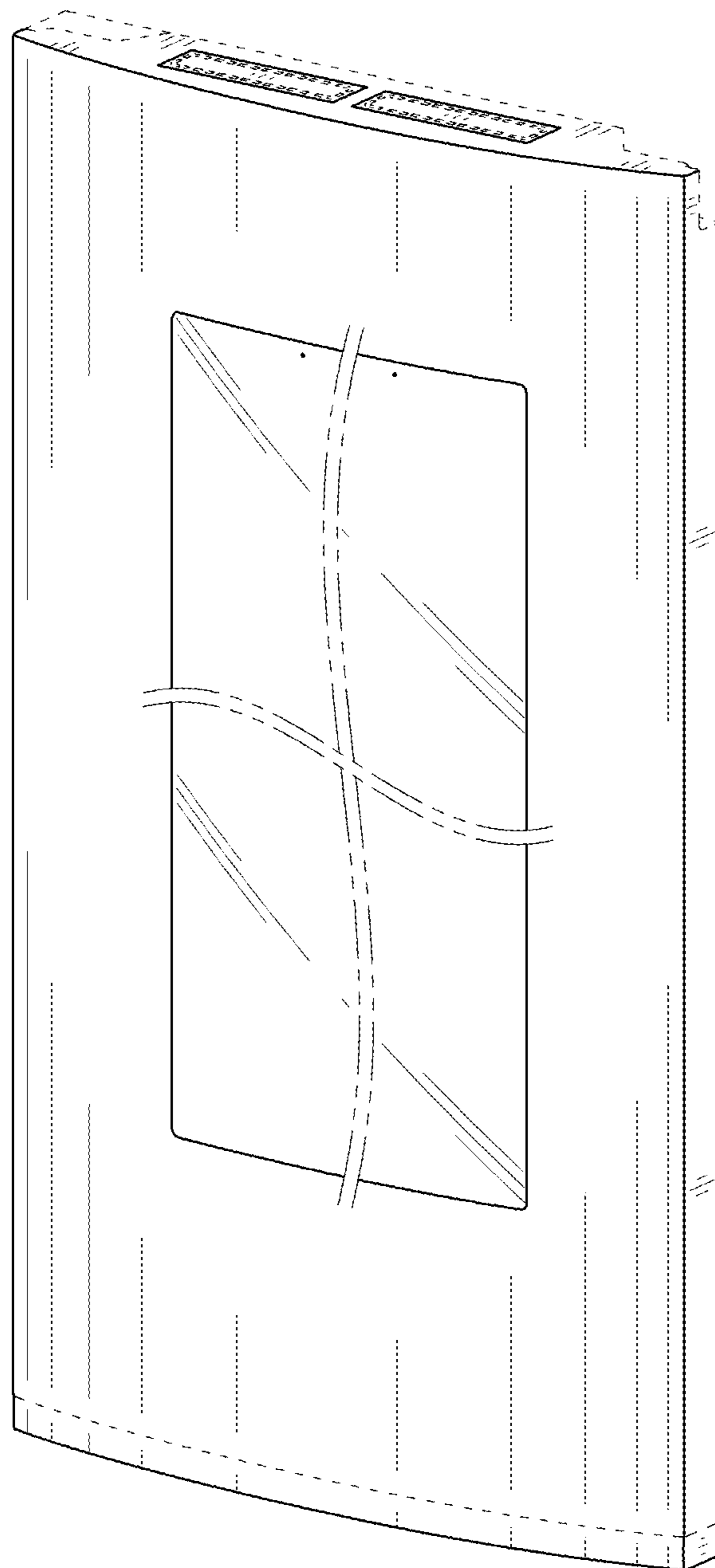

FIG. 30

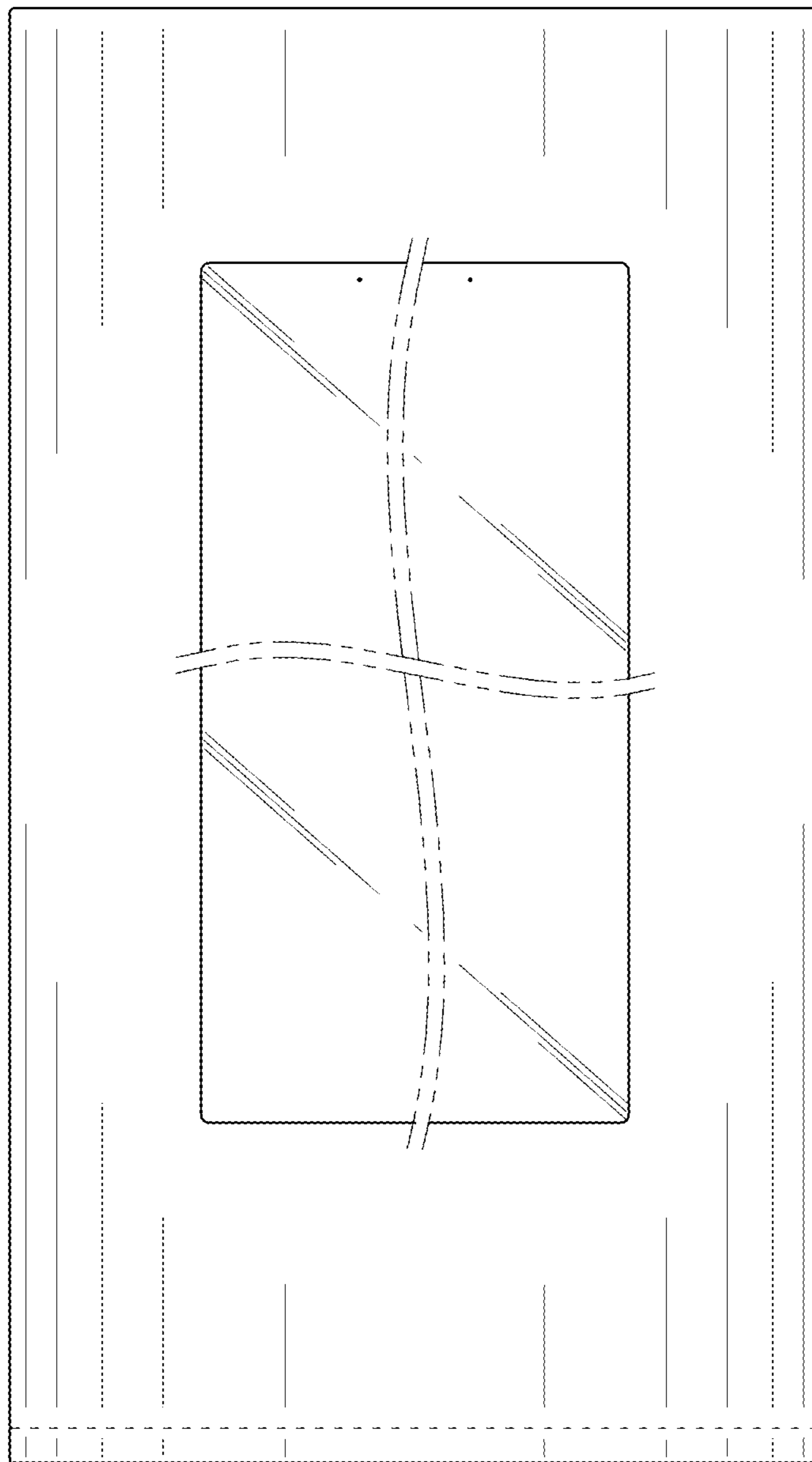



FIG. 31



FIG. 32

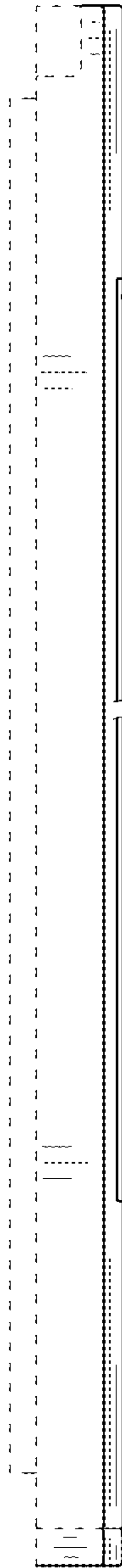

FIG. 33

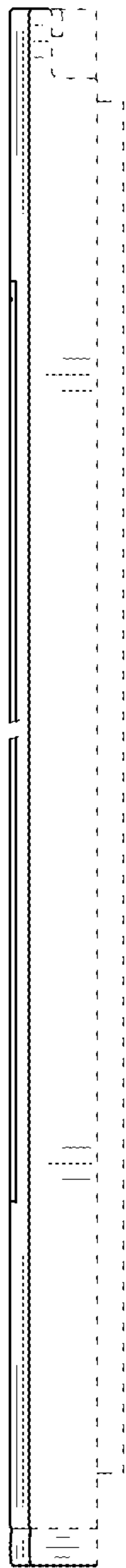

FIG. 34

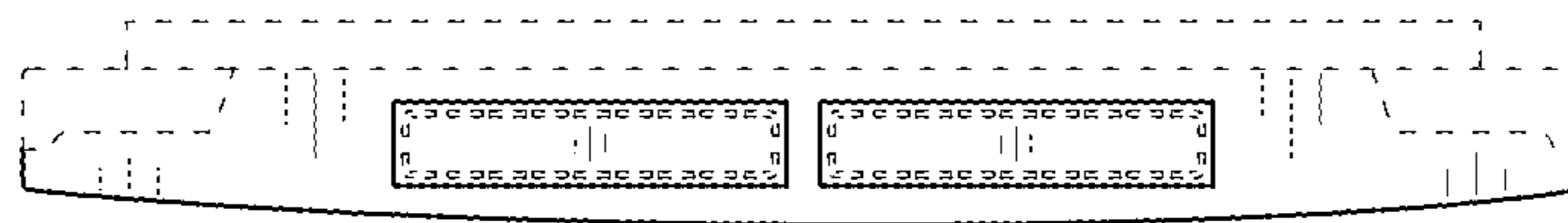

FIG. 35

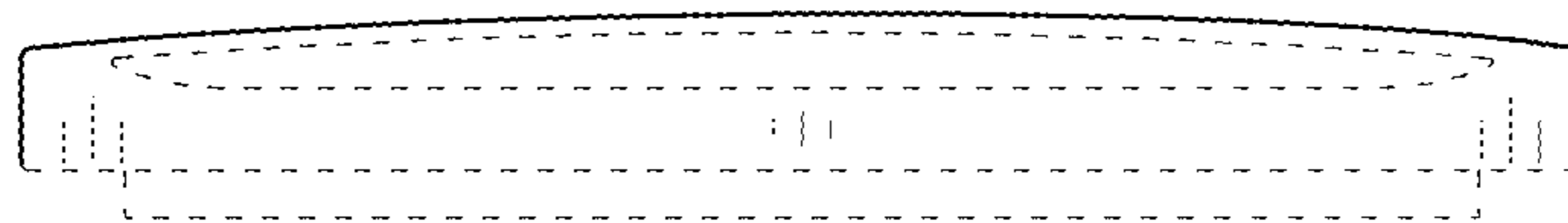

FIG. 36

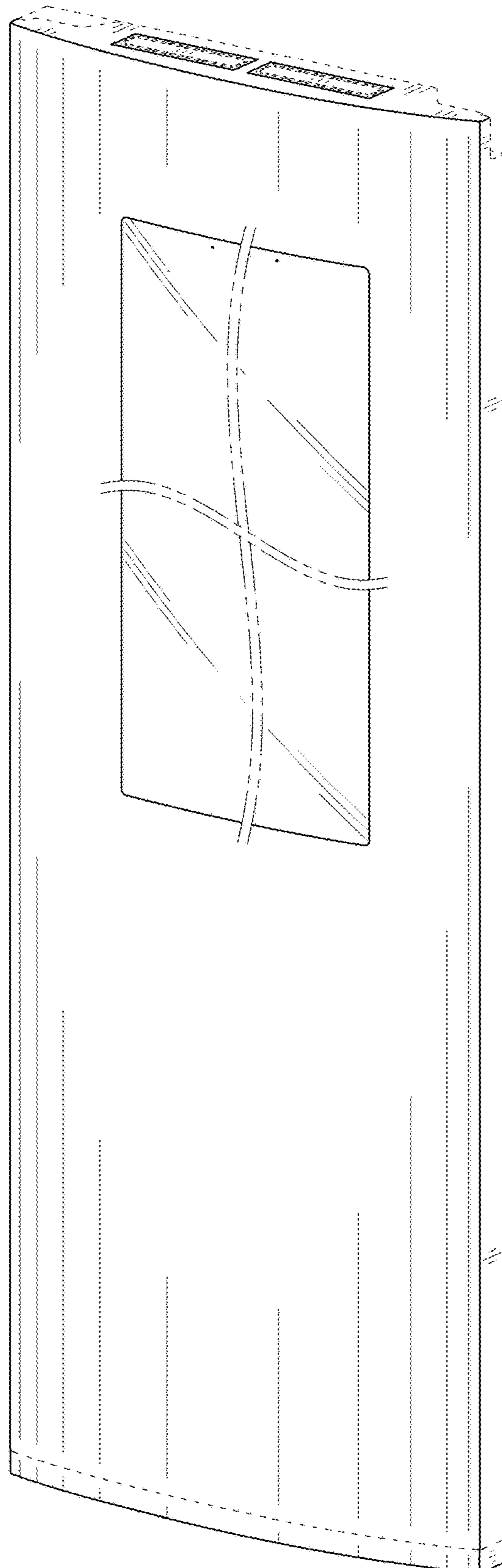

FIG. 37

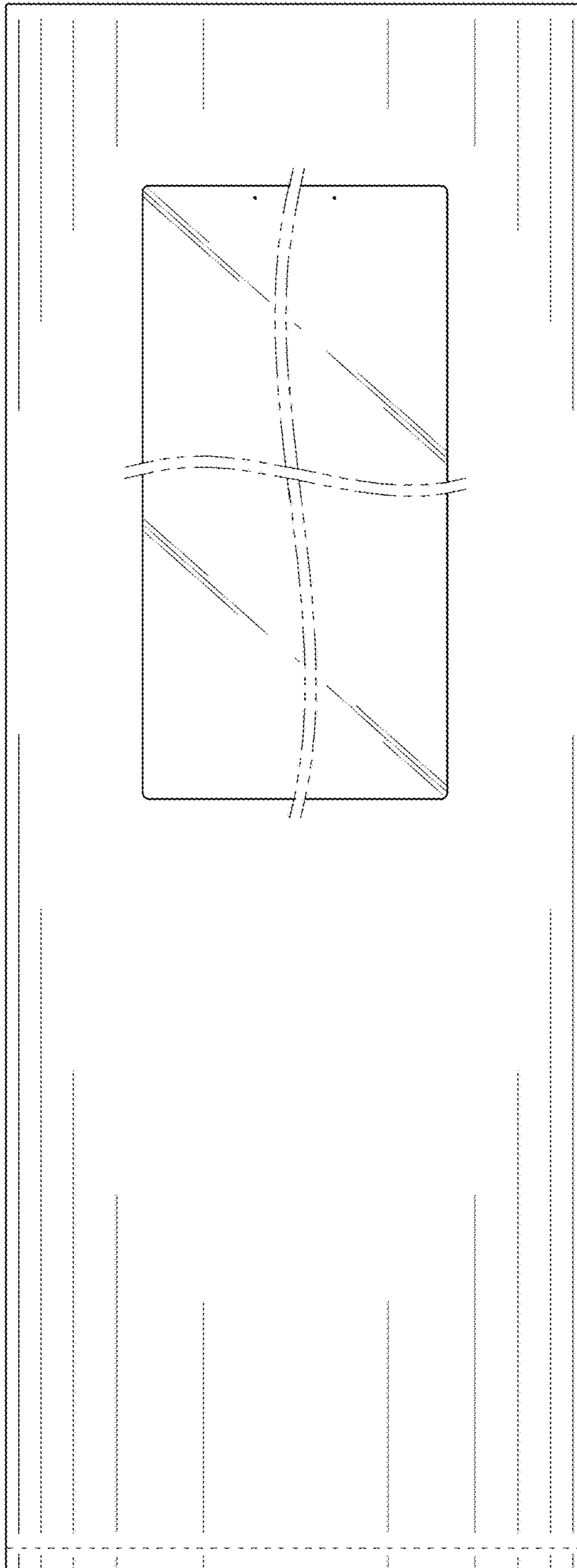

FIG. 38





FIG. 39



FIG. 40

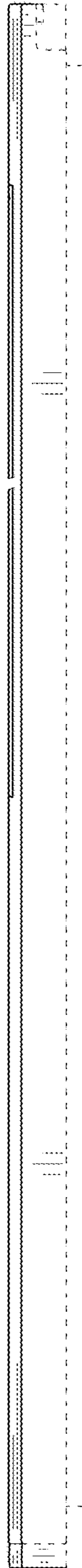

FIG. 41

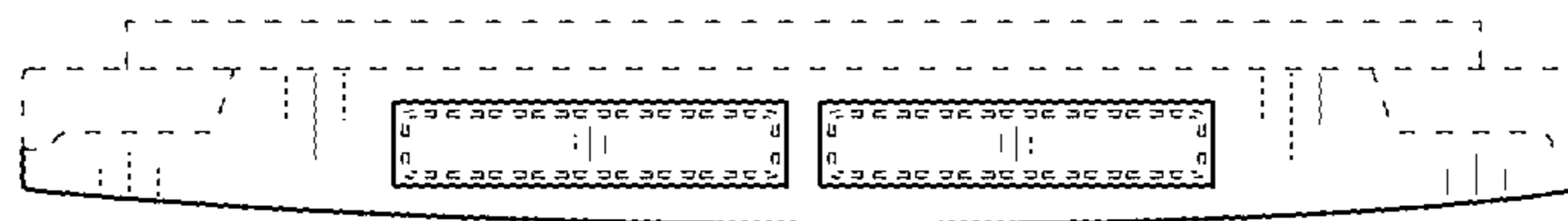

FIG. 42

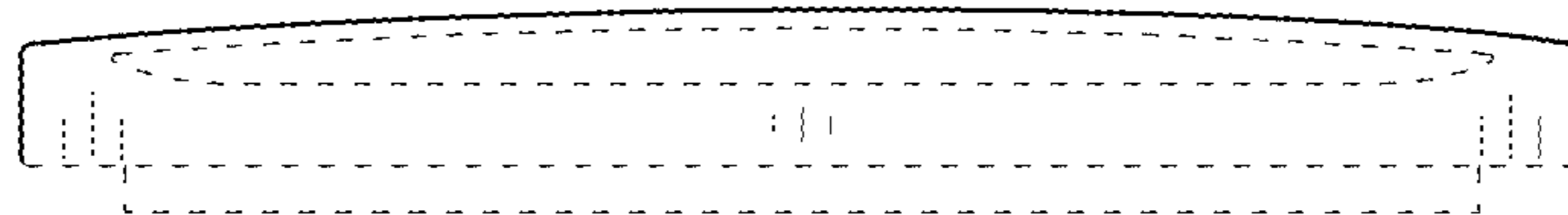

FIG. 43

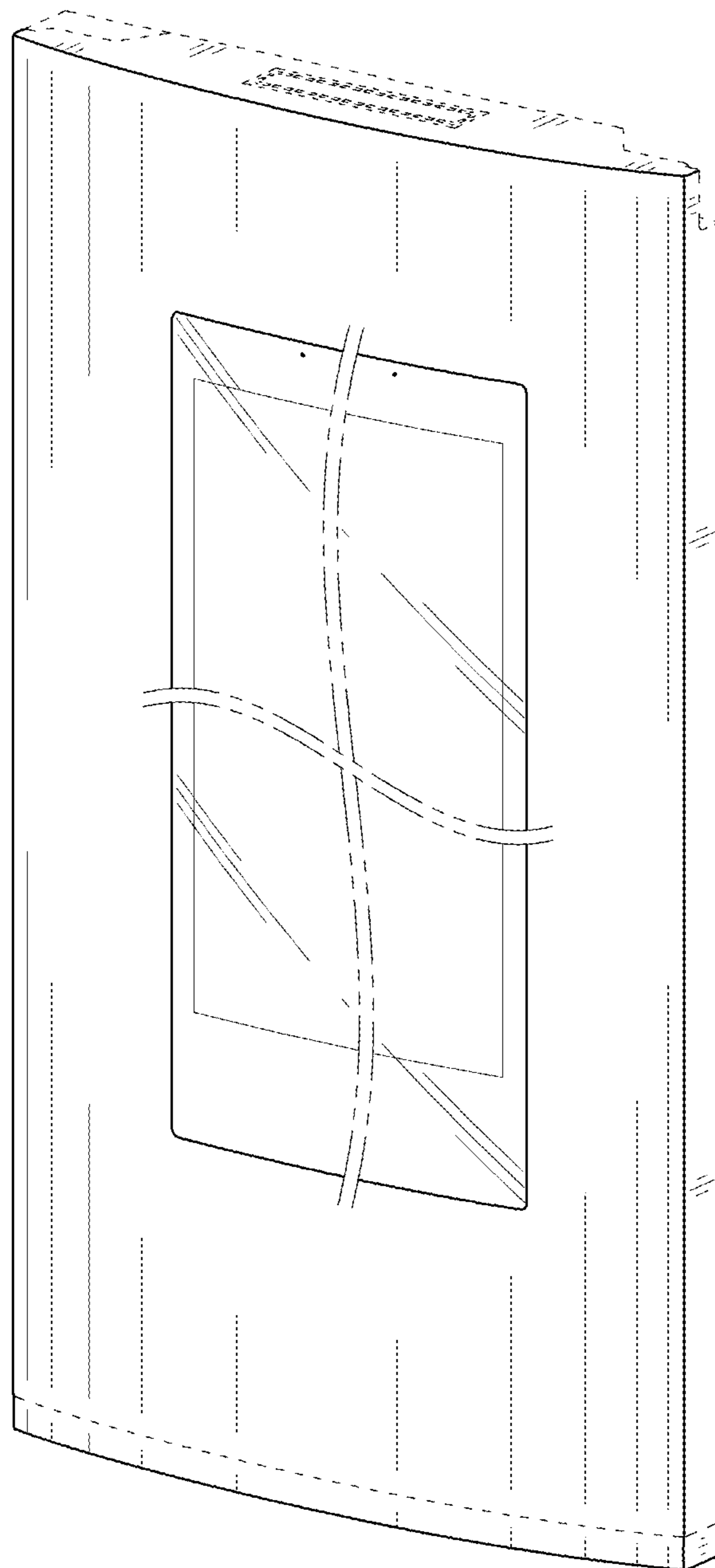

FIG. 44

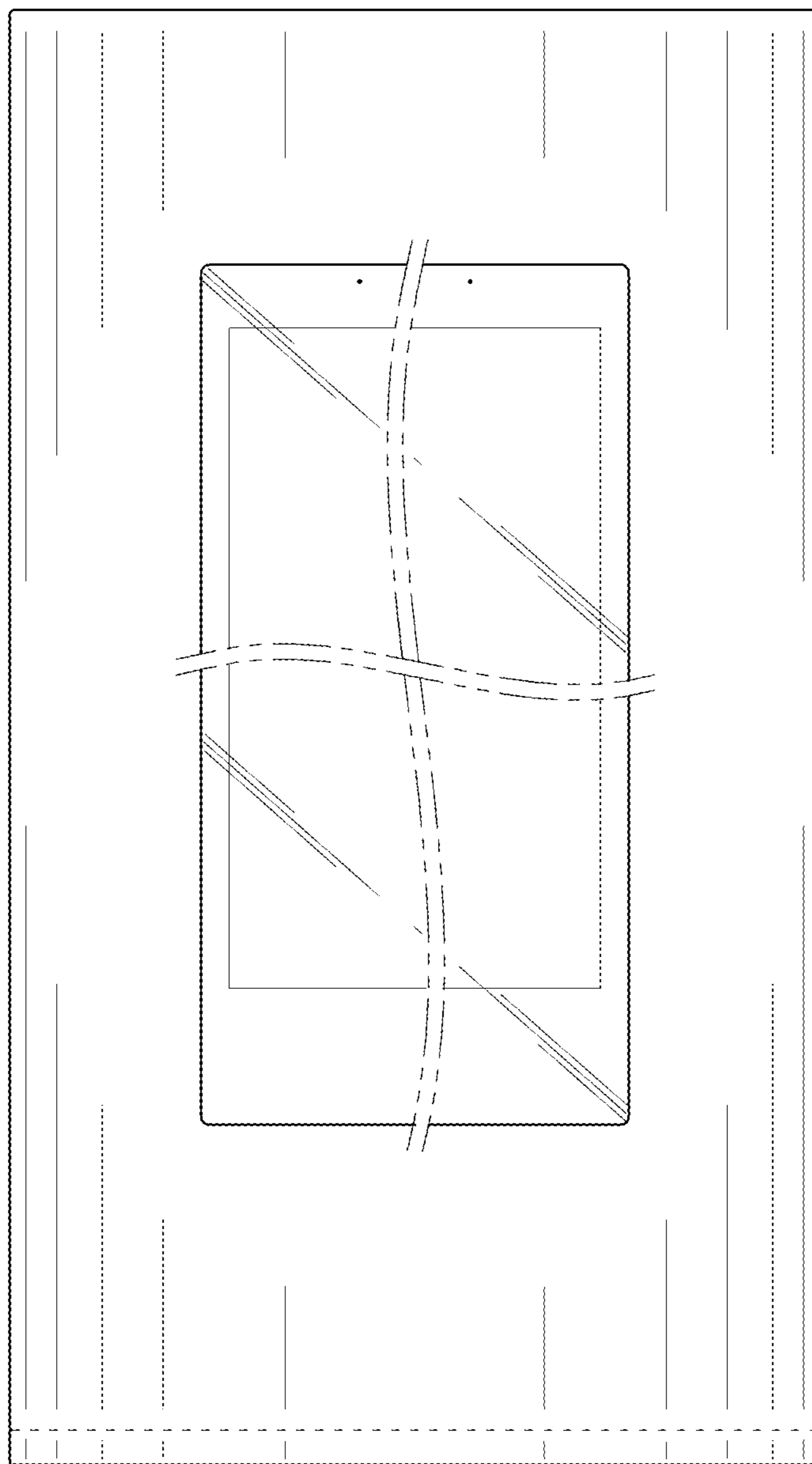

FIG. 45



FIG. 46

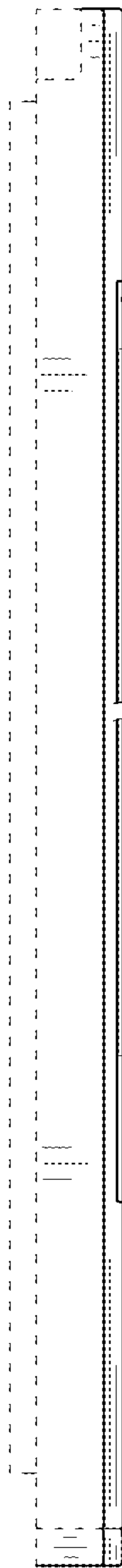



FIG. 47

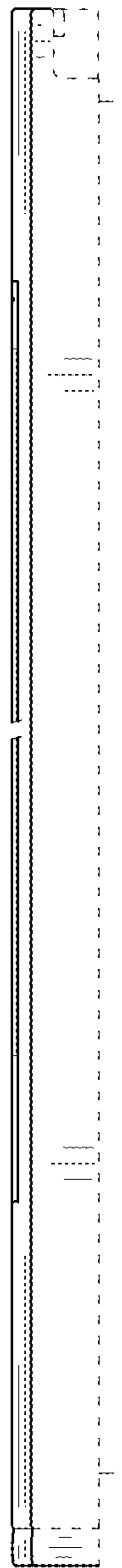

FIG. 48

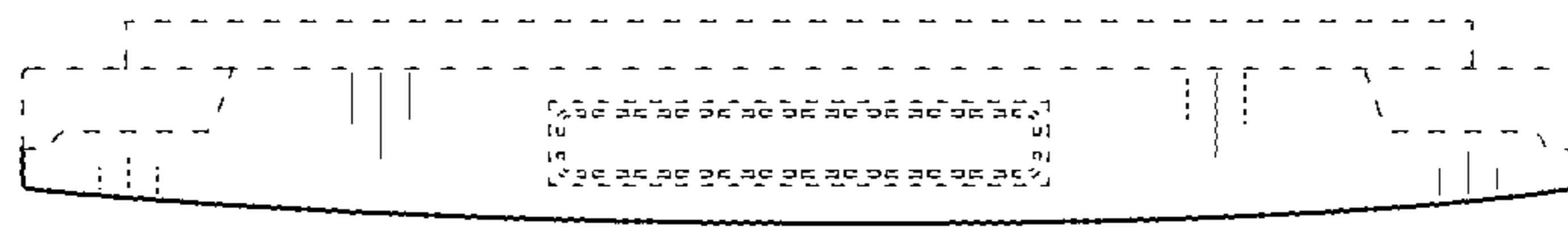

FIG. 49

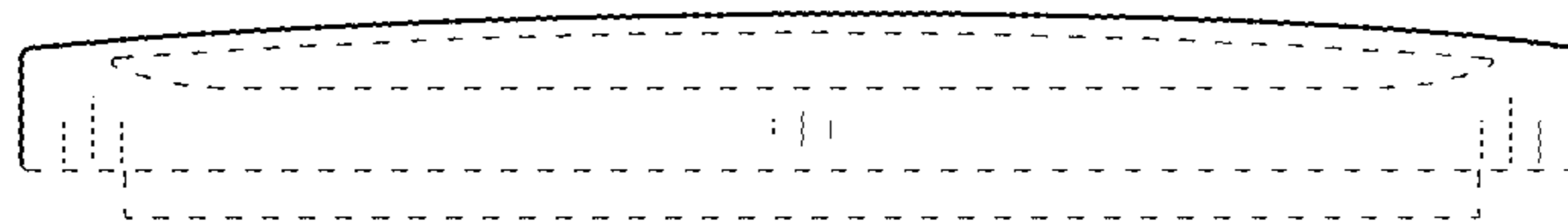

FIG. 50

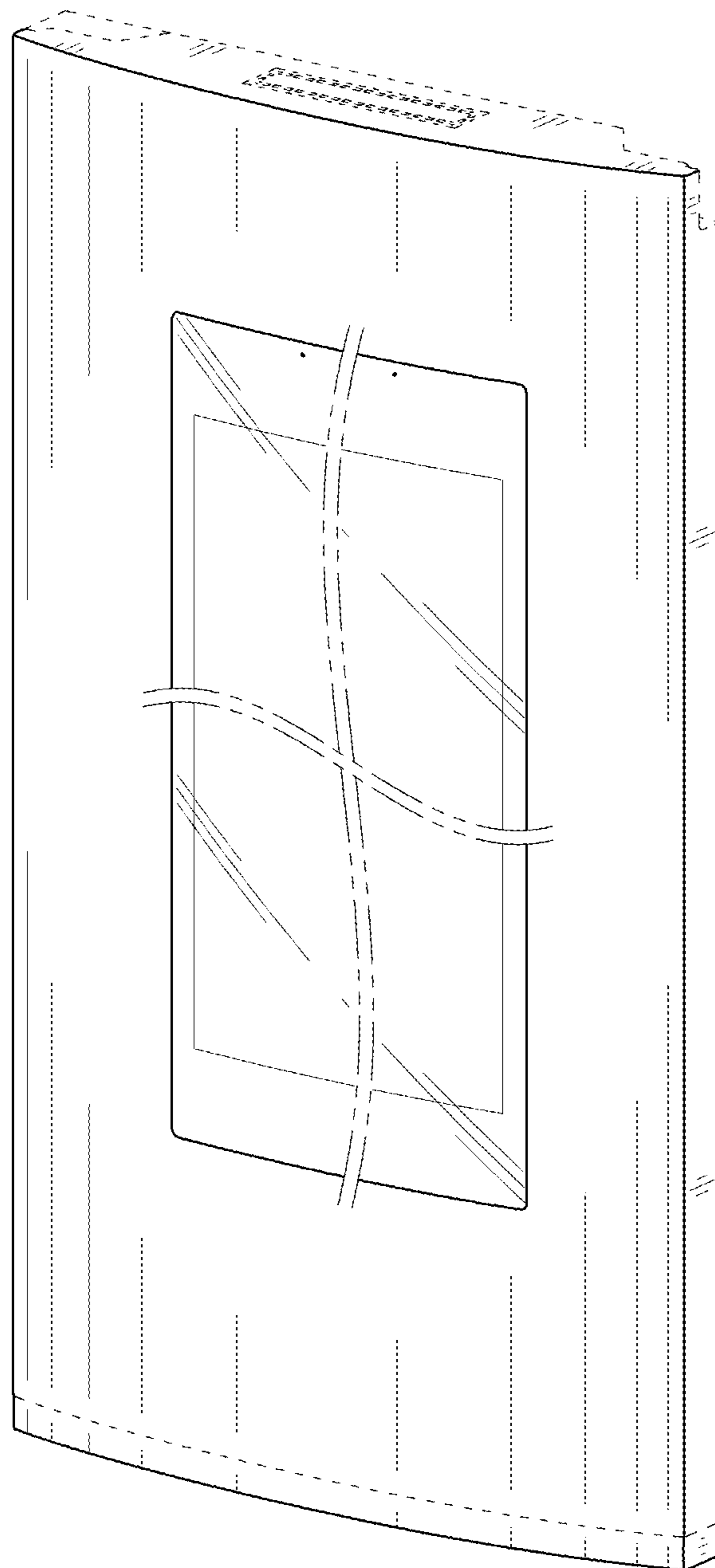

FIG. 51

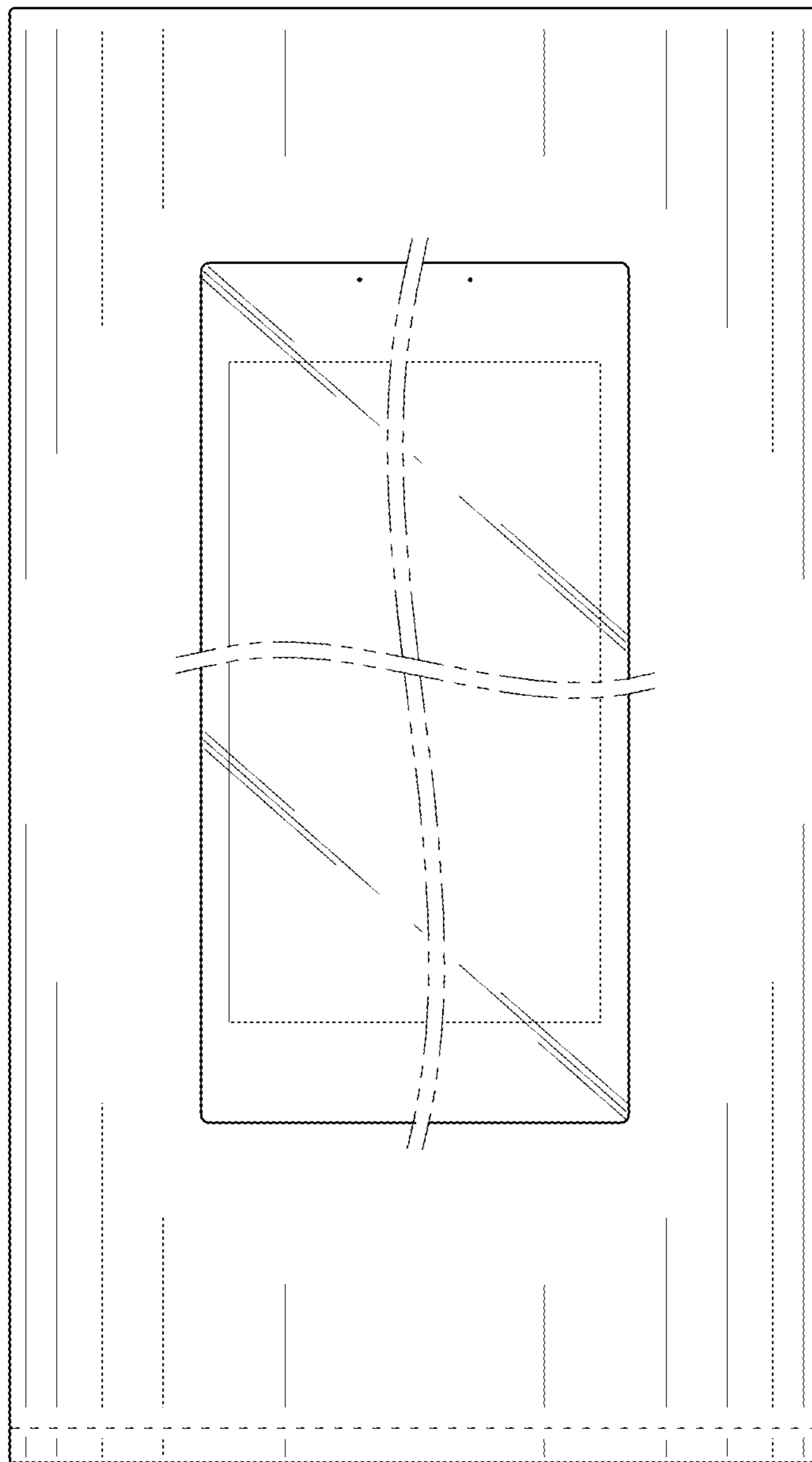

FIG. 52



FIG. 53

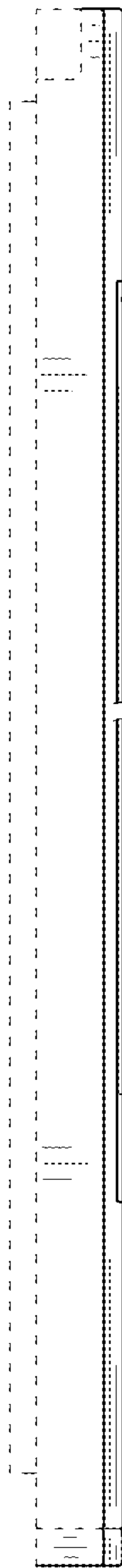

FIG. 54

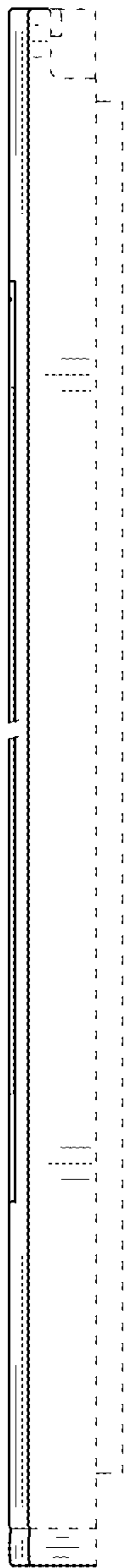



FIG. 55

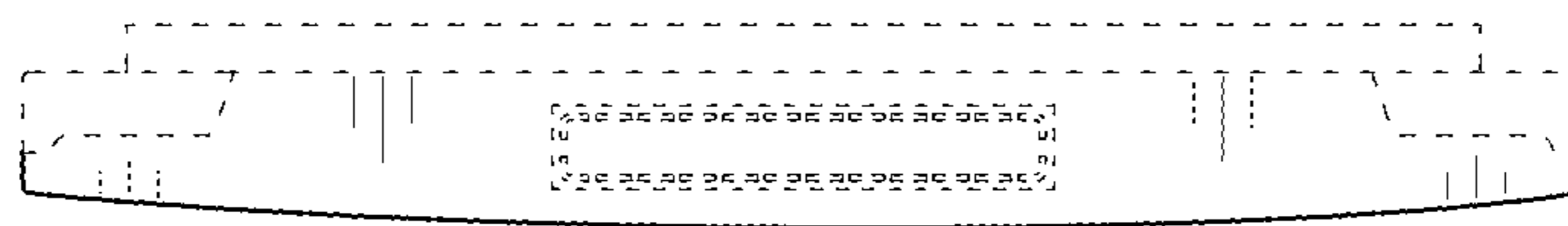

FIG. 56

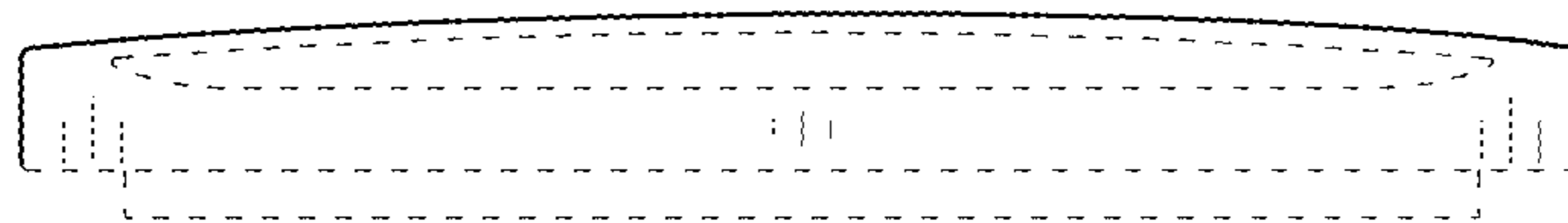

FIG. 57

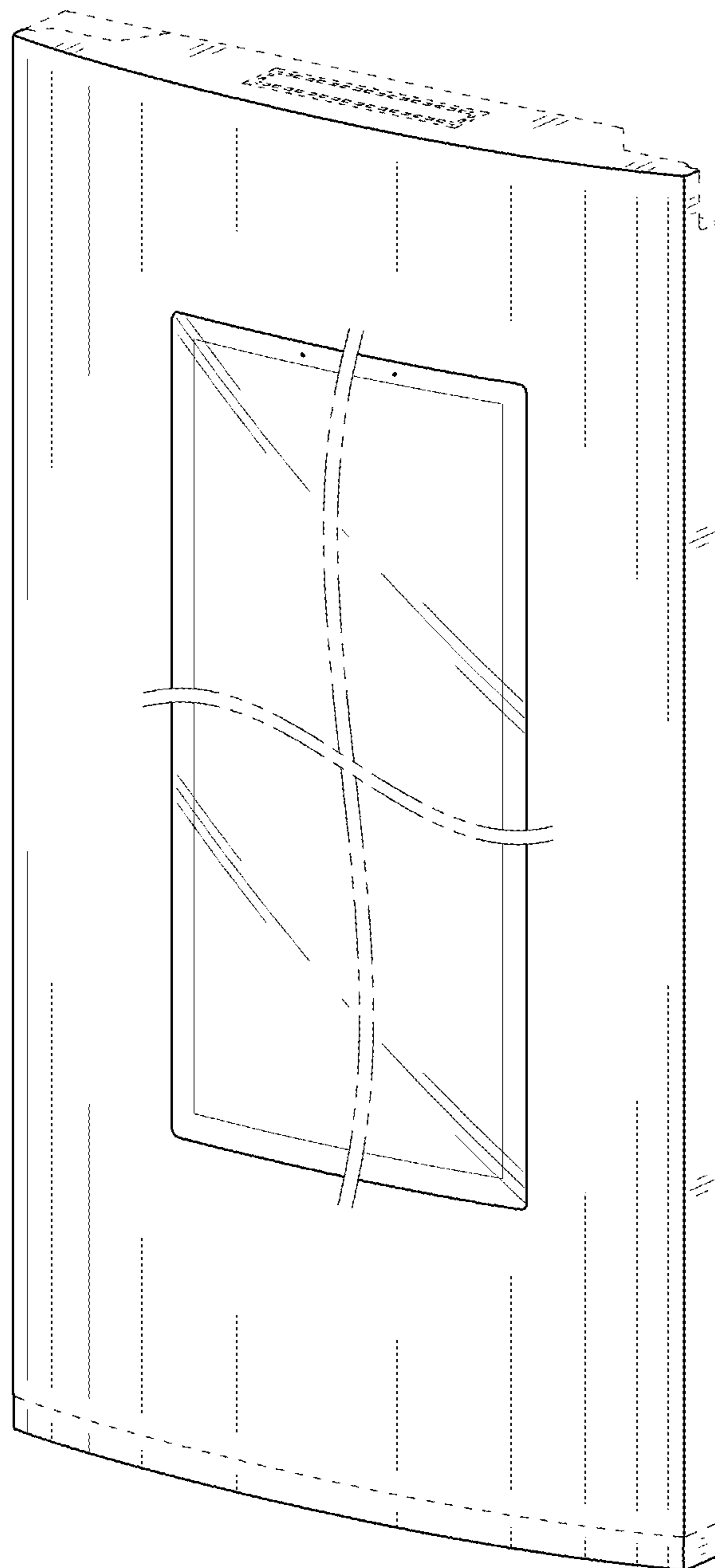

FIG. 58

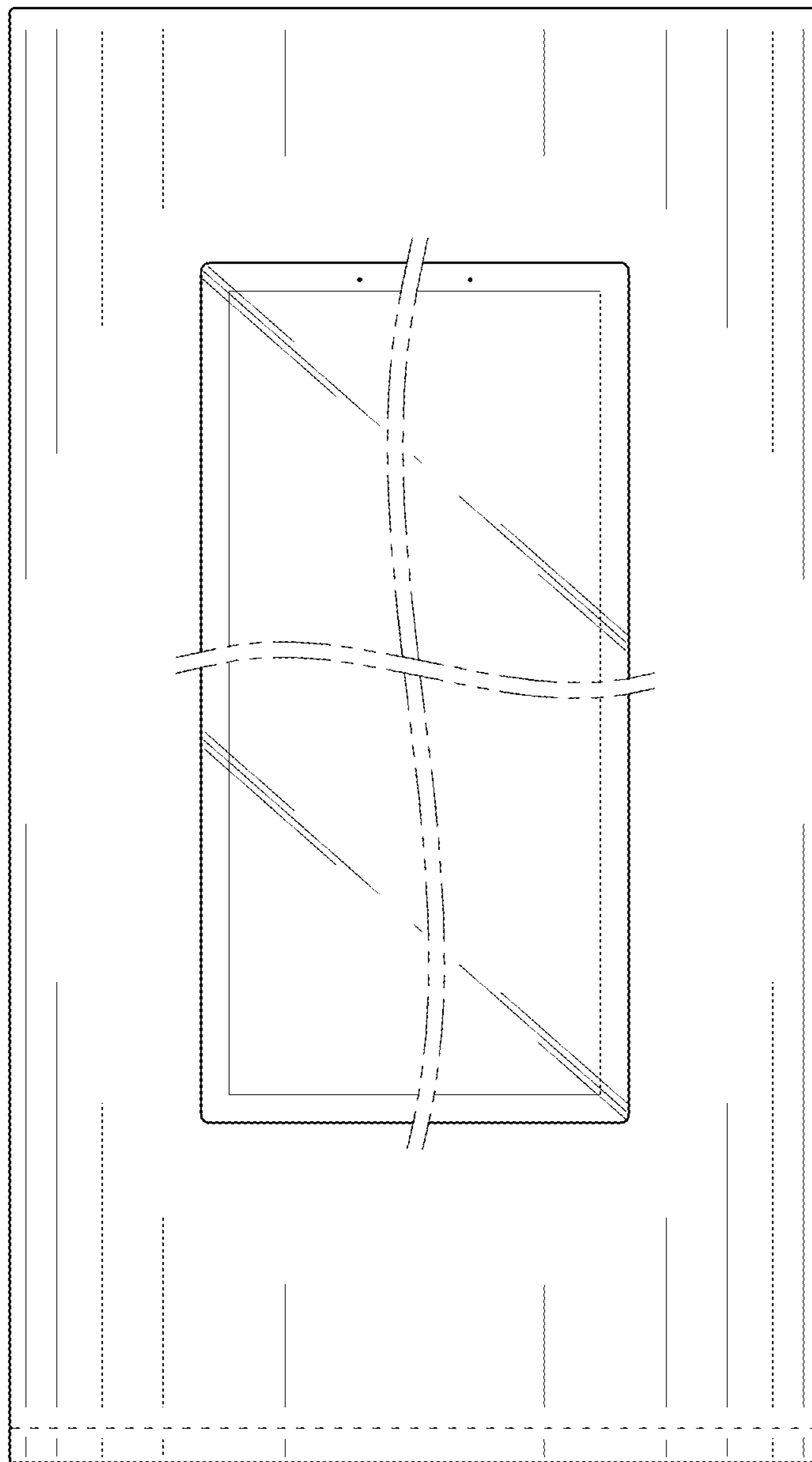

FIG. 59



FIG. 60

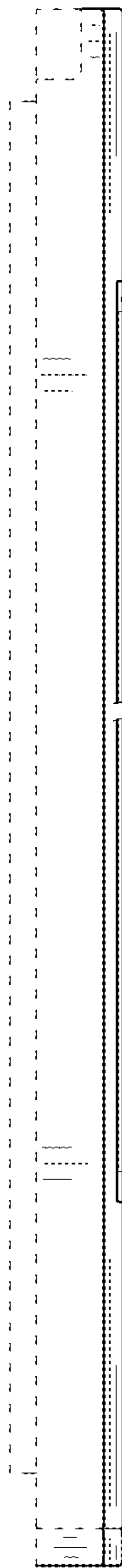

FIG. 61

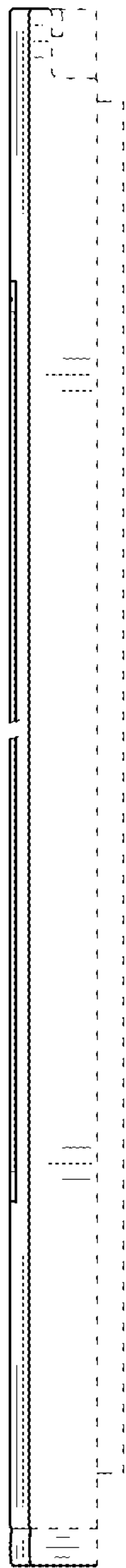

FIG. 62

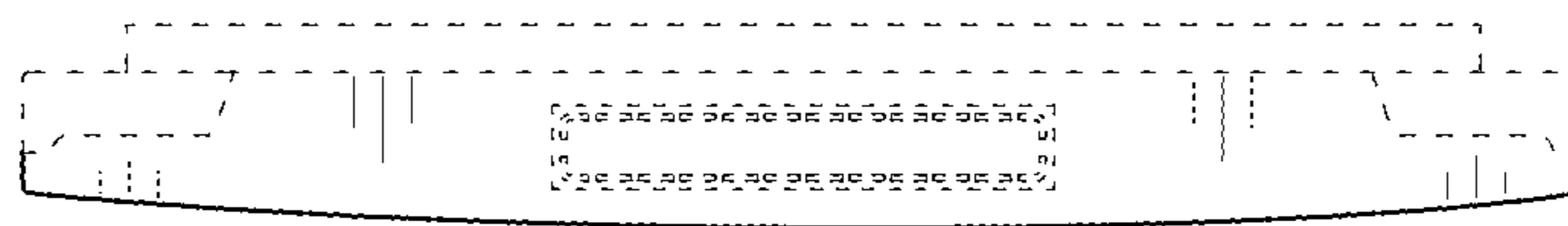



FIG. 63

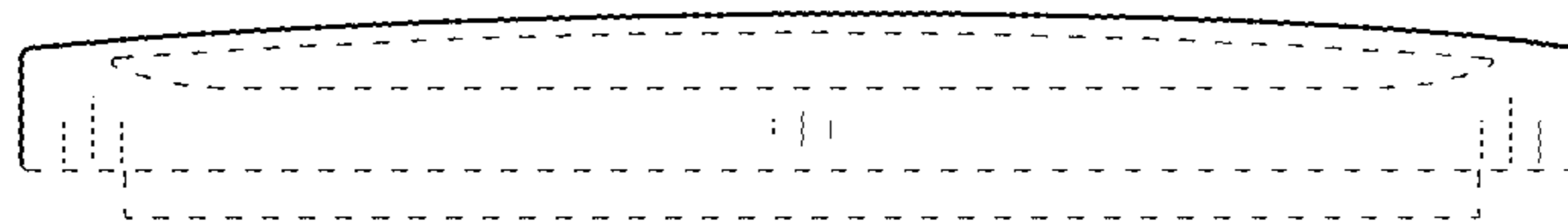

FIG. 64

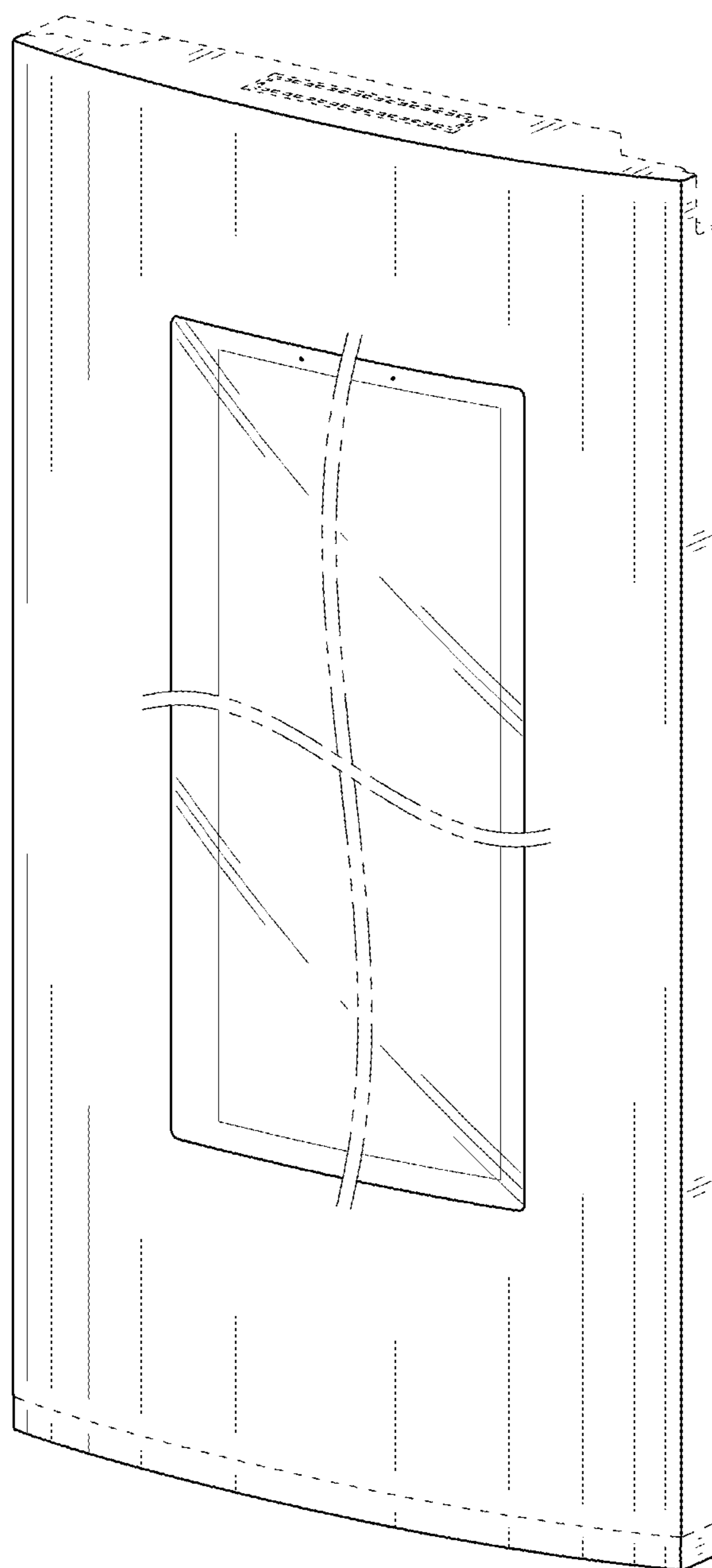

FIG. 65

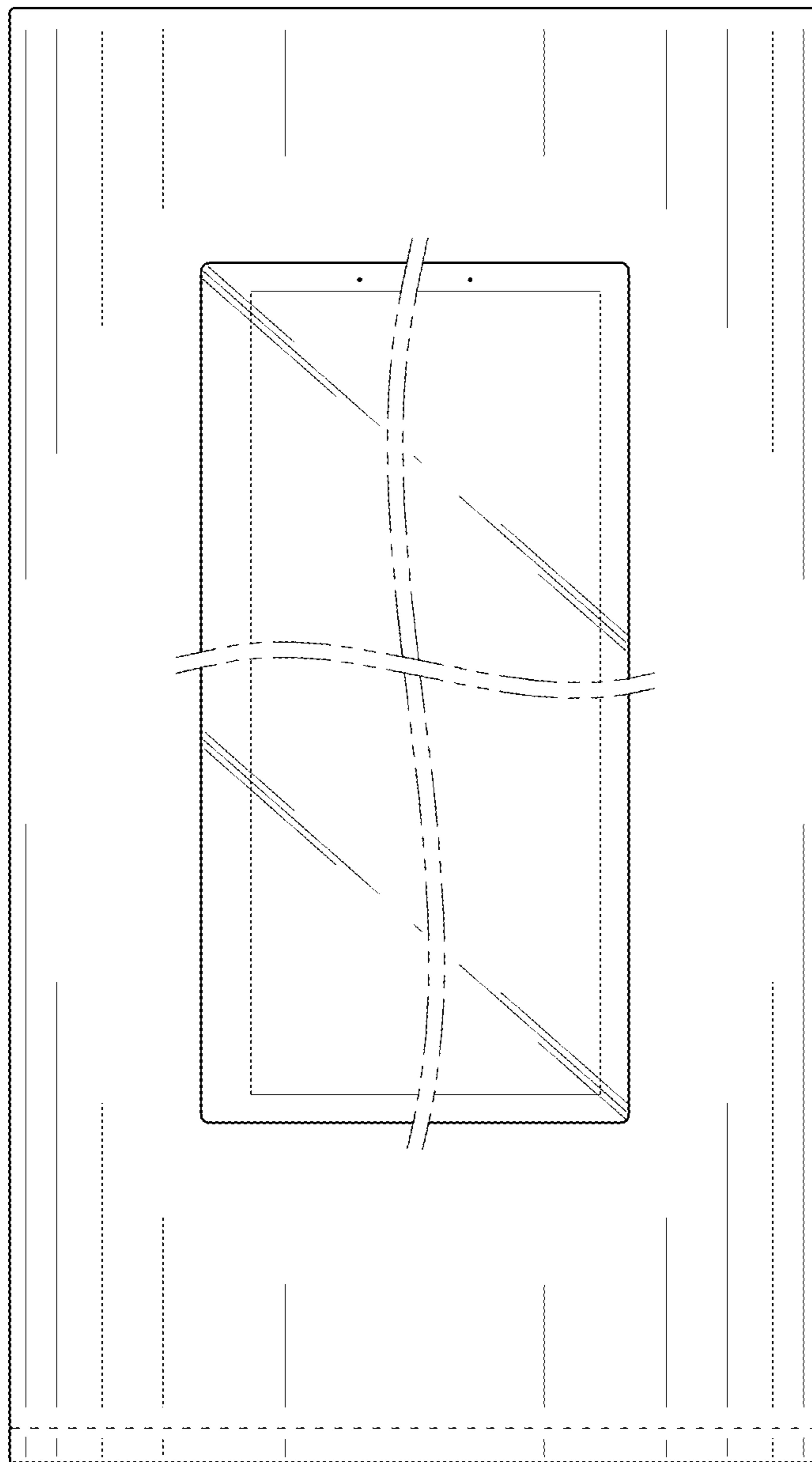

FIG. 66



FIG. 67

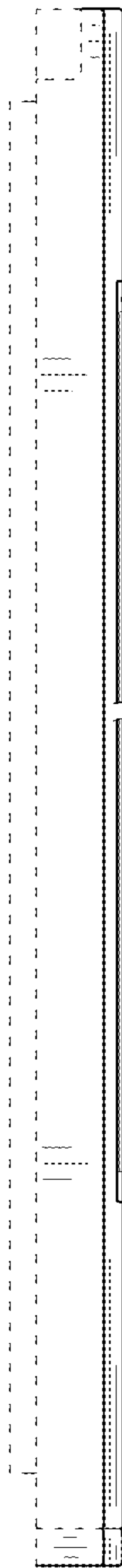

FIG. 68

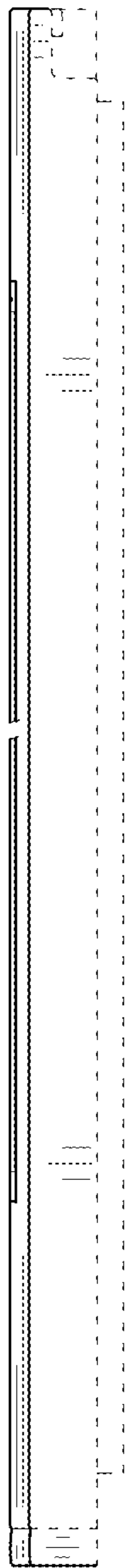

FIG. 69

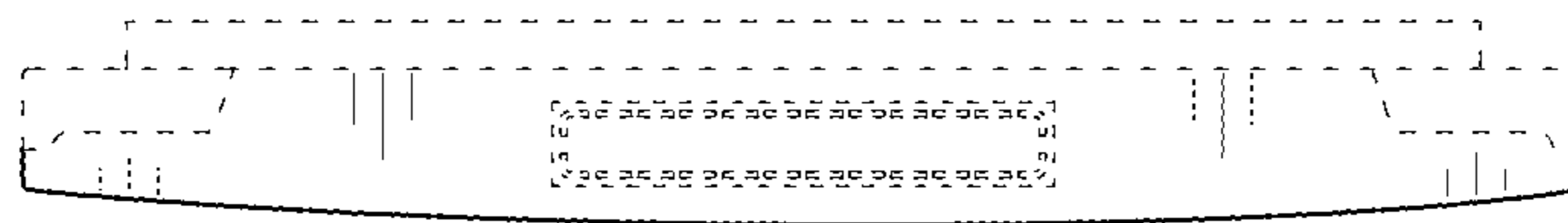

FIG. 70

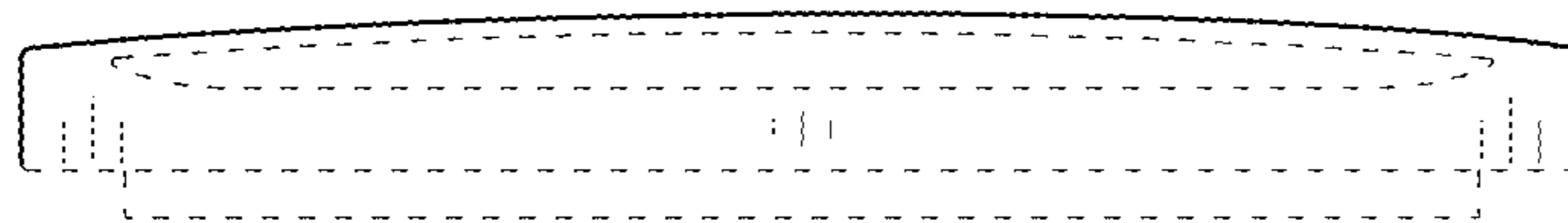



FIG. 71

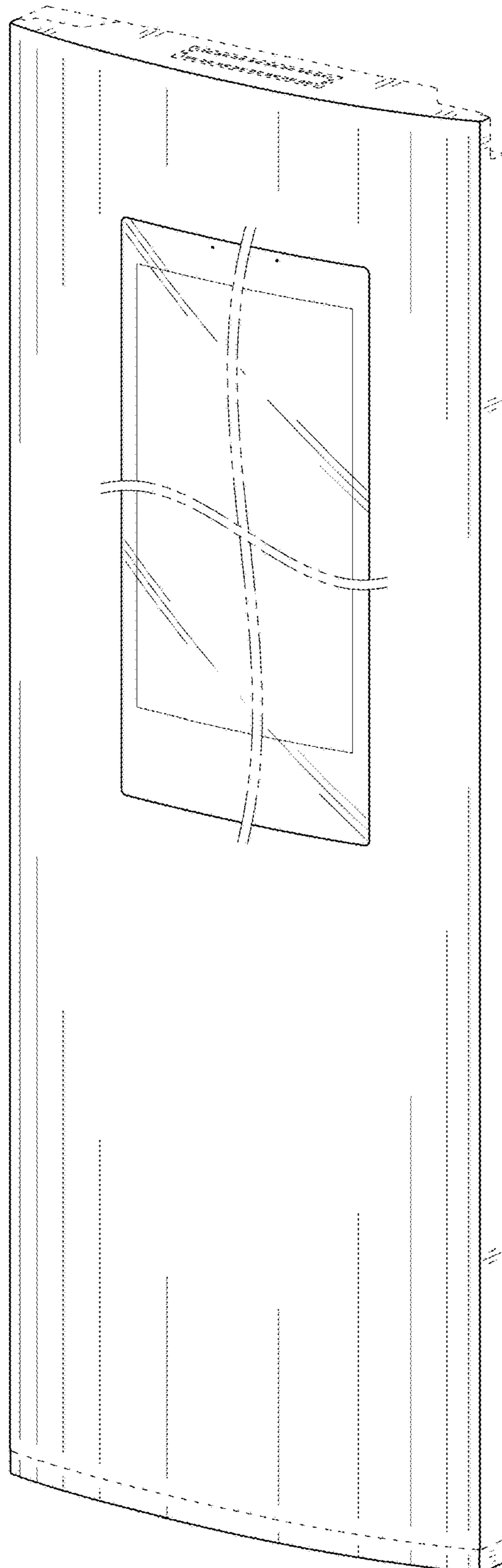

FIG. 72

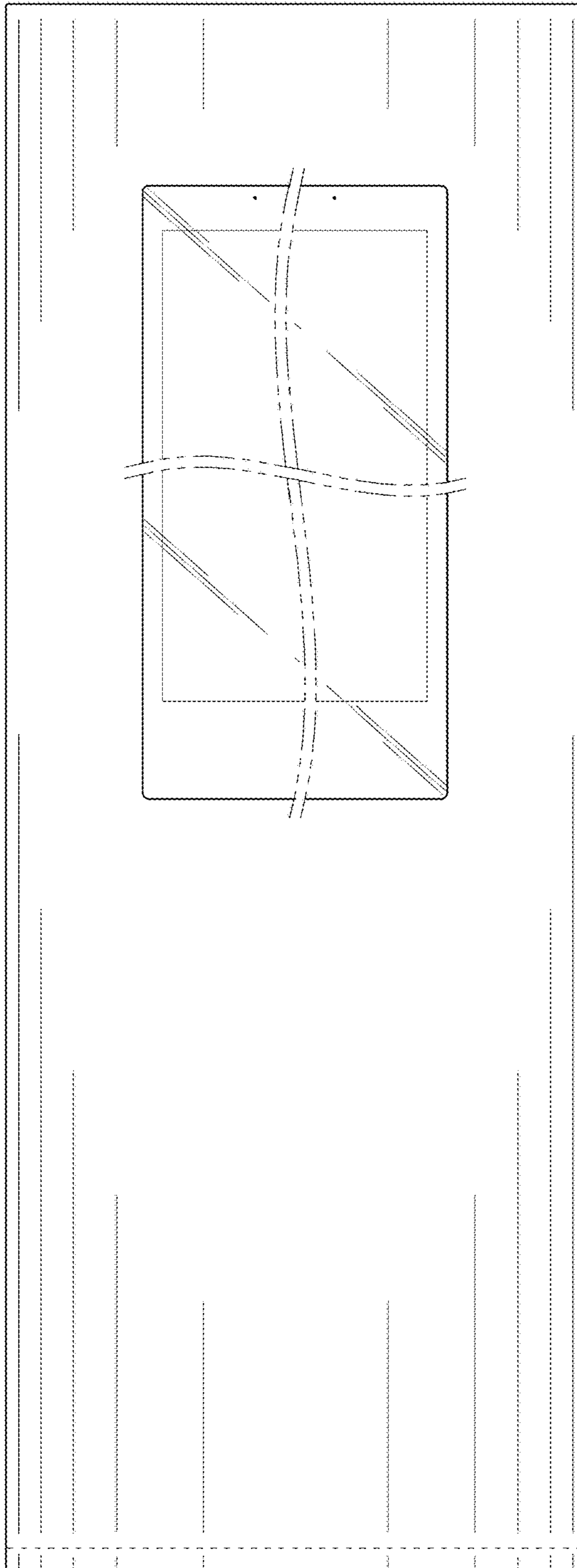

FIG. 73



FIG. 74

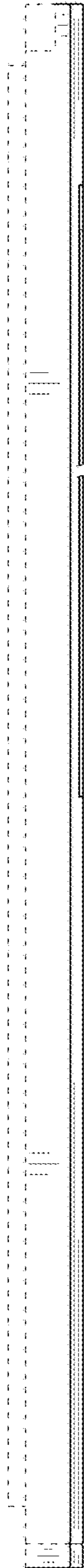

FIG. 75

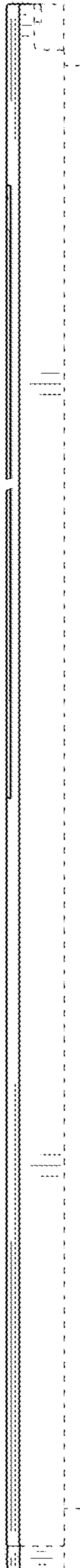

FIG. 76

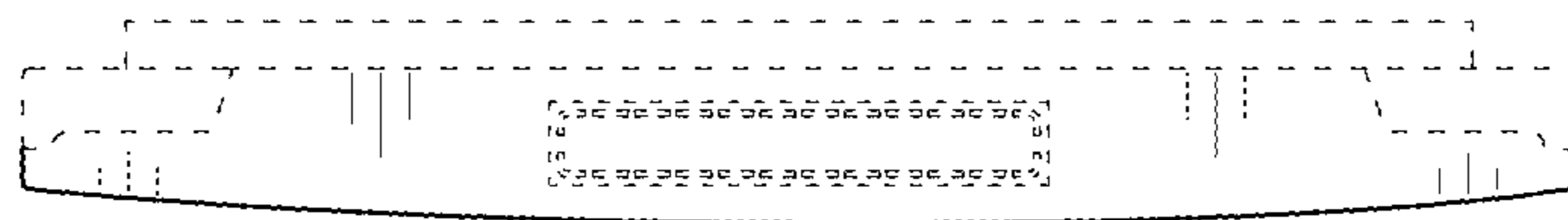

FIG. 77

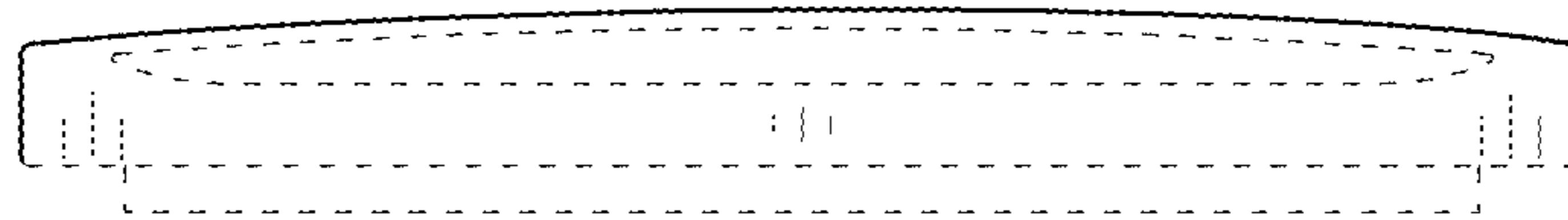

FIG. 78

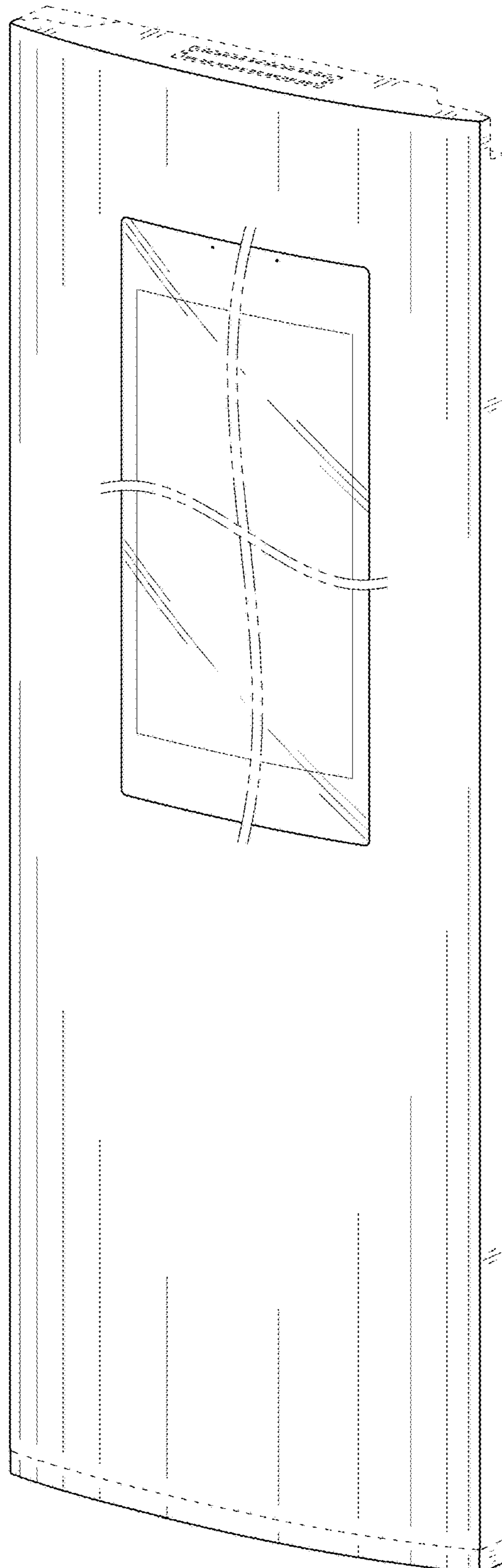



FIG. 79

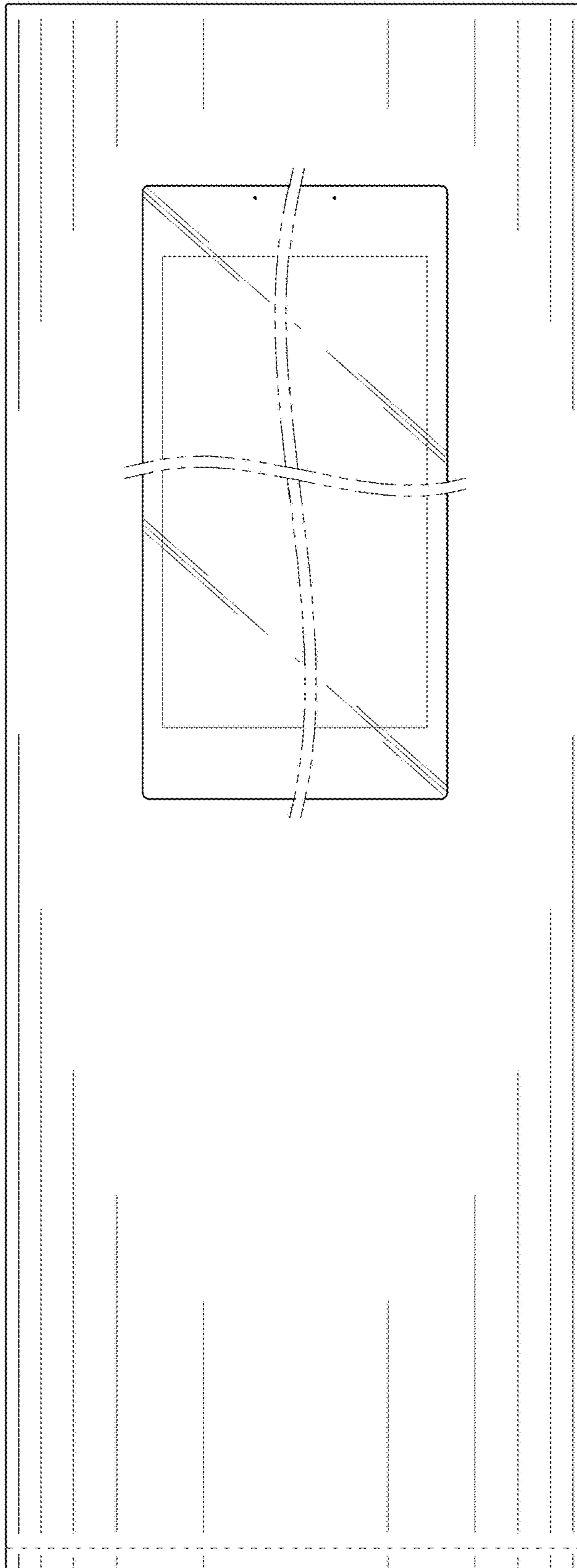

FIG. 80



FIG. 81

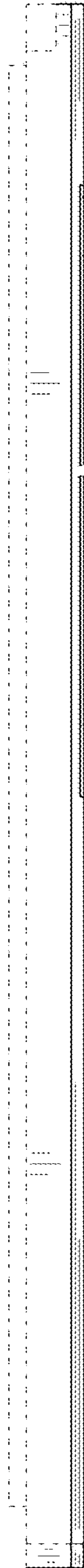

FIG. 82

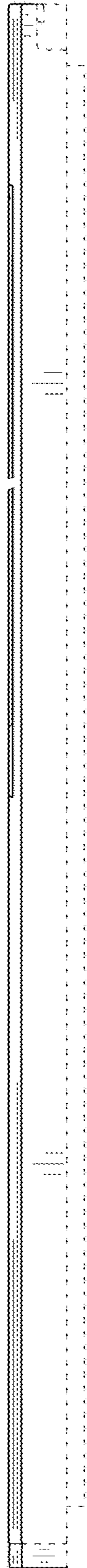

FIG. 83

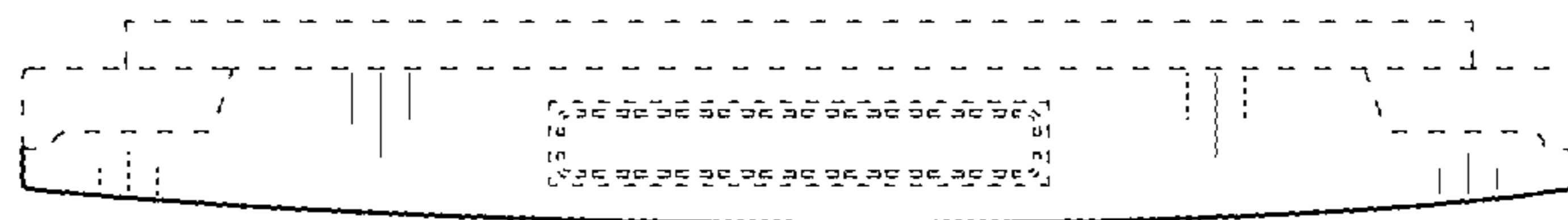

FIG. 84



FIG. 85

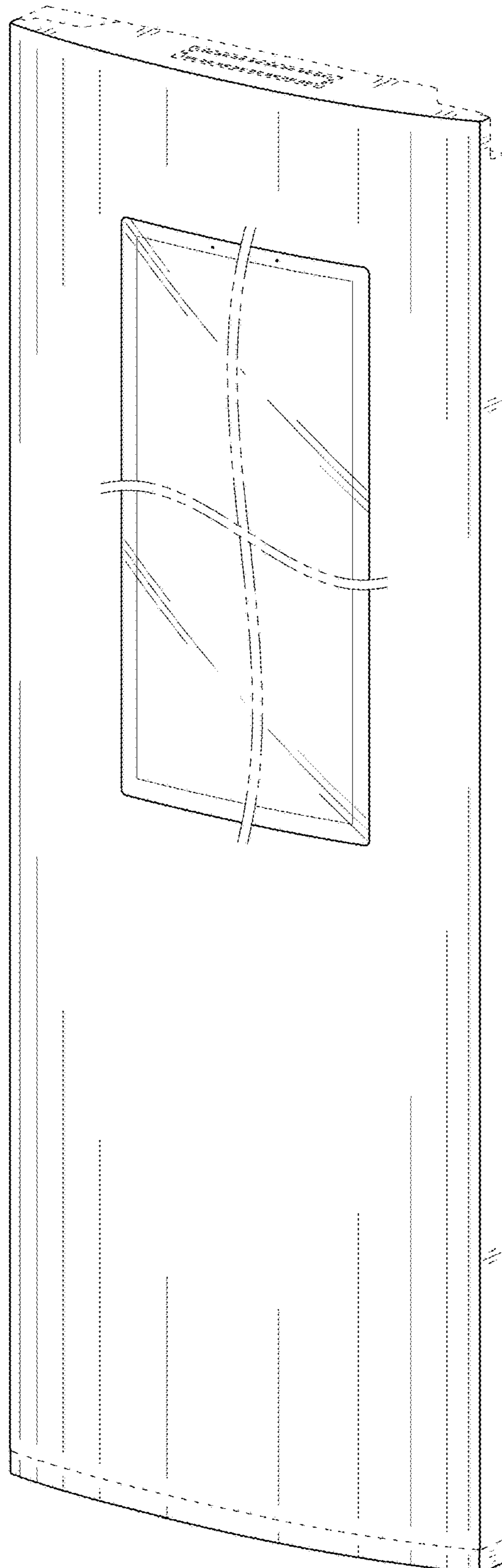

FIG. 86

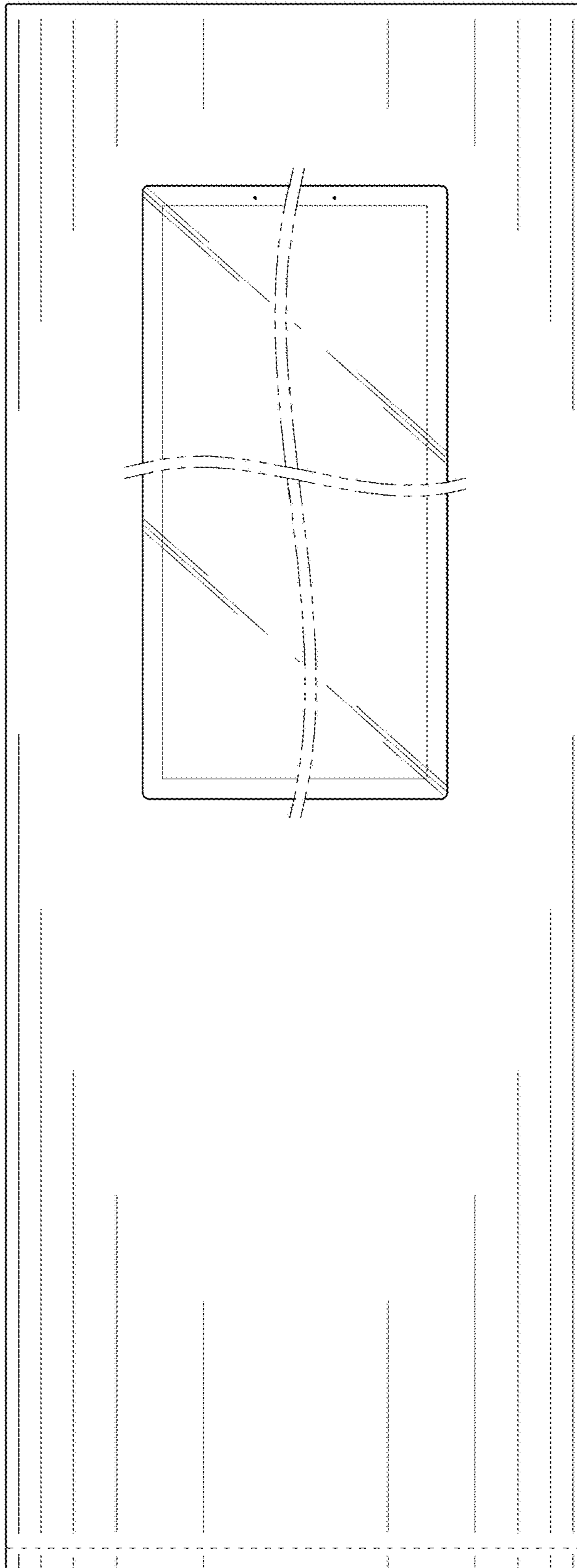



FIG. 87

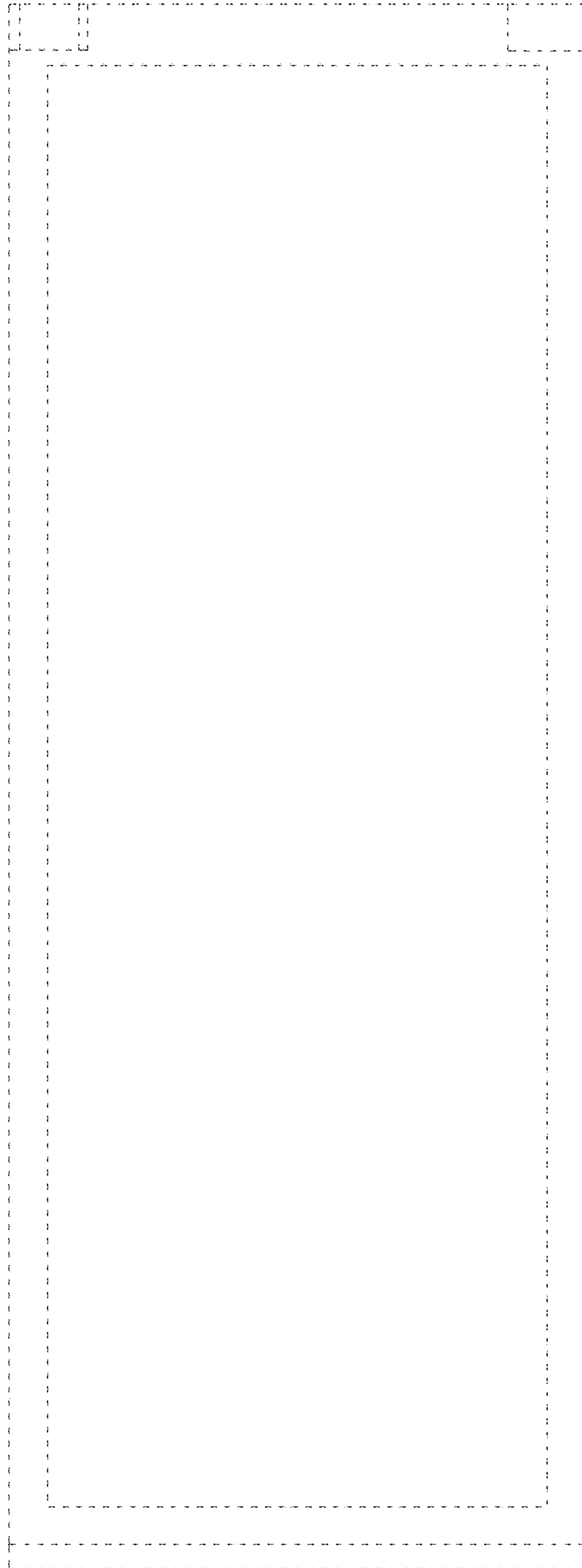

FIG. 88

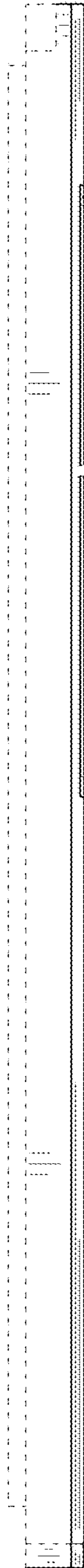

FIG. 89

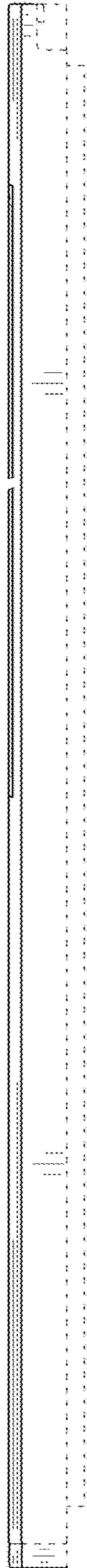

FIG. 90

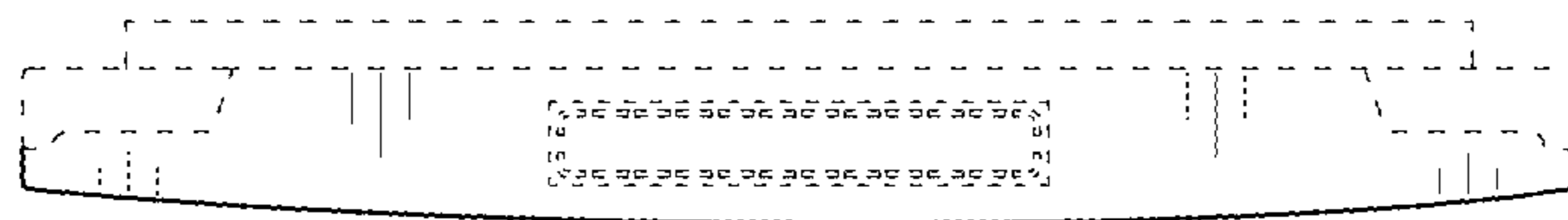

FIG. 91



FIG. 92

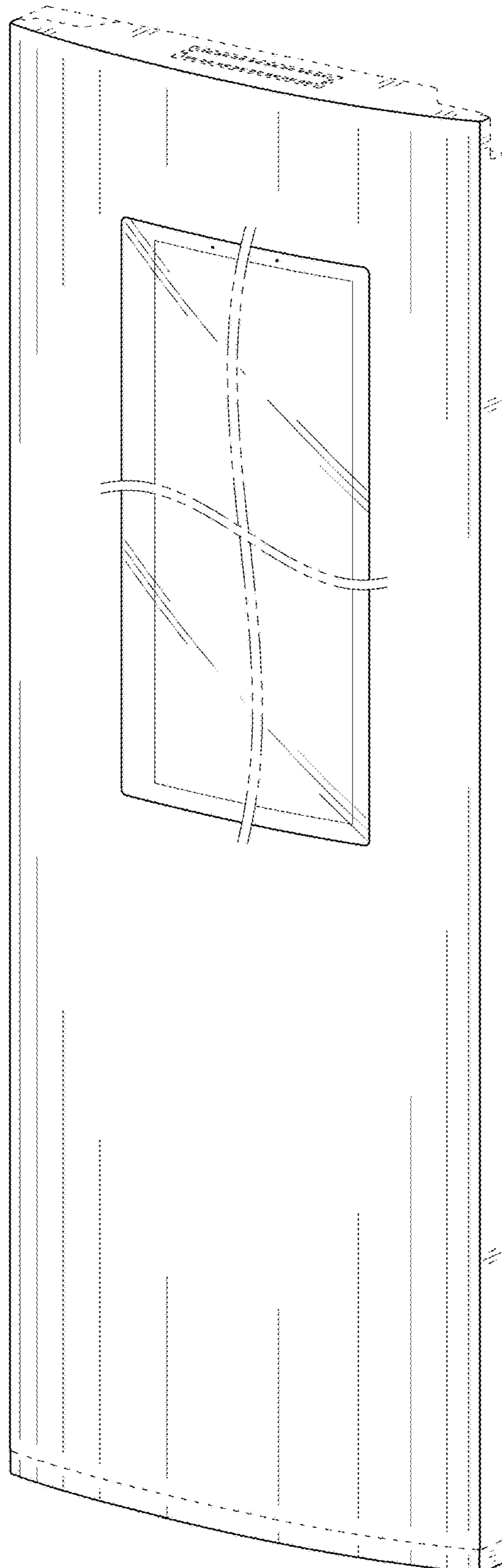

FIG. 93

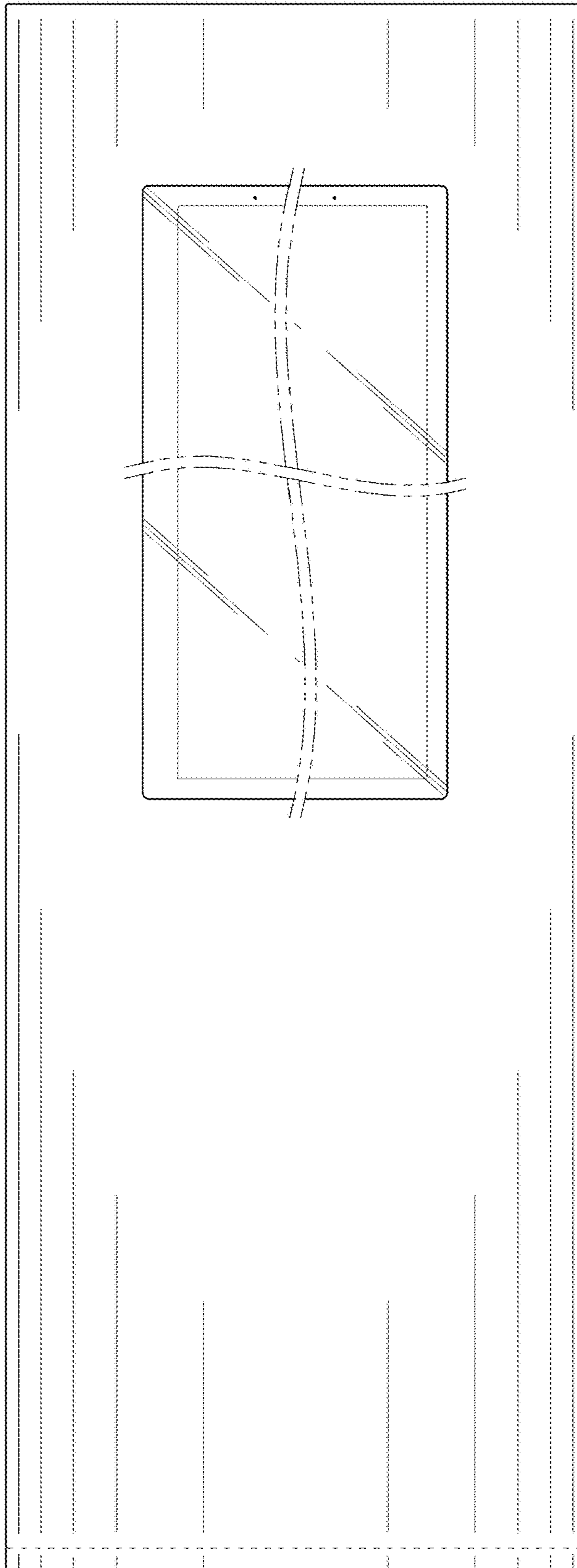

FIG. 94





FIG. 95

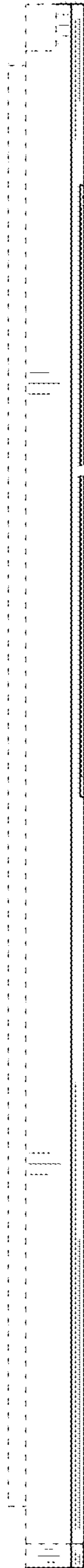

FIG. 96

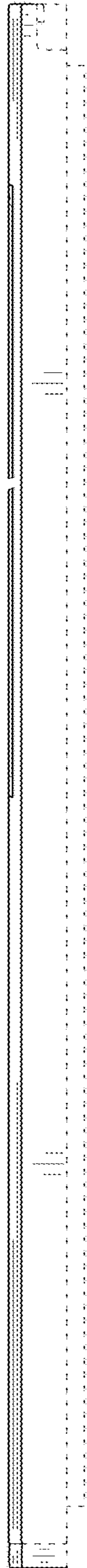

FIG. 97

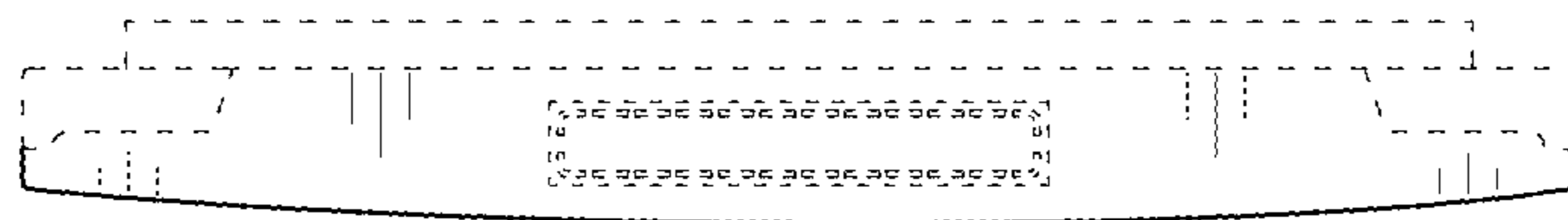

FIG. 98

