



US00D868849S

(12) **United States Design Patent**
Hynes

(10) **Patent No.:** **US D868,849 S**
(45) **Date of Patent:** **** Dec. 3, 2019**

(54) **APPLIANCE WITH BACKLIT FEATURE**

DESCRIPTION

- (71) Applicant: **Vinotemp International Corporation**, Irvine, CA (US)
- (72) Inventor: **India Hynes**, Laguna Beach, CA (US)
- (73) Assignee: **VINOTEMP INTERNATIONAL CORPORATION**, Irvine, CA (US)
- (**) Term: **15 Years**
- (21) Appl. No.: **29/625,644**
- (22) Filed: **Nov. 10, 2017**
- (51) **LOC (12) Cl.** **15-07**
- (52) **U.S. Cl.**
USPC **D15/81**
- (58) **Field of Classification Search**
USPC D15/79-91
(Continued)

(56) **References Cited**

U.S. PATENT DOCUMENTS

- 1,847,147 A * 3/1932 Thomas, Jr. H02G 3/06
174/68.3
- 2,250,156 A * 7/1941 Ferguson H01R 4/026
174/84 R

(Continued)

OTHER PUBLICATIONS

Office Action, dated May 1, 2019, in U.S. Appl. No. 87/404,929.
(Continued)

Primary Examiner — Khawaja Anwar

(74) *Attorney, Agent, or Firm* — Knobbe, Martens, Olson & Bear, LLP

(57) **CLAIM**

The ornamental design for an appliance with backlit feature or portion thereof, as shown and described.

FIG. 1 is a perspective view of an appliance with backlit feature with certain features shown in dashed lines disclaimed. In particular, the handle, the interior racks and the front light elements are disclaimed.
 FIG. 2 is a front view thereof;
 FIG. 3 is a rear view thereof;
 FIG. 4 is a left side view thereof;
 FIG. 5 is a right side view thereof;
 FIG. 6 is a top view thereof;
 FIG. 7 is a bottom view thereof;
 FIG. 8 is a perspective view of an appliance with backlit feature;
 FIG. 9 is a front view thereof;
 FIG. 10 is a perspective view of an interior rack of the appliance with backlit feature separate from the appliance.
 FIG. 11 is a front view thereof;
 FIG. 12 is a rear view thereof;
 FIG. 13 is a left side view thereof;
 FIG. 14 is a right side view thereof;
 FIG. 15 is a perspective view of an appliance with backlit feature;
 FIG. 16 is a front view thereof;
 FIG. 17 is a rear view thereof;
 FIG. 18 is a left side view thereof;
 FIG. 19 is a right side view thereof;
 FIG. 20 is a top view thereof; and
 FIG. 21 is a bottom view thereof.
 The broken lines in the drawings illustrate portions of the appliance with backlit feature that form no part of the claimed design. The portions between the break lines in FIGS. 15-19 represent an indeterminate length and form no part of the claimed design.
 In FIGS. 1-21, the stippling on the back panel represents the backlit feature of the appliance. As shown in FIGS. 1, 2, 8, 9, 15, and 16, the backlighting is located at a periphery of the rear interior panel of the appliance. The backlighting is brightest at the periphery and fades toward the interior of the rear panel. In FIGS. 8-14, the handle, front lighting and the interior racks are disclaimed.

1 Claim, 16 Drawing Sheets

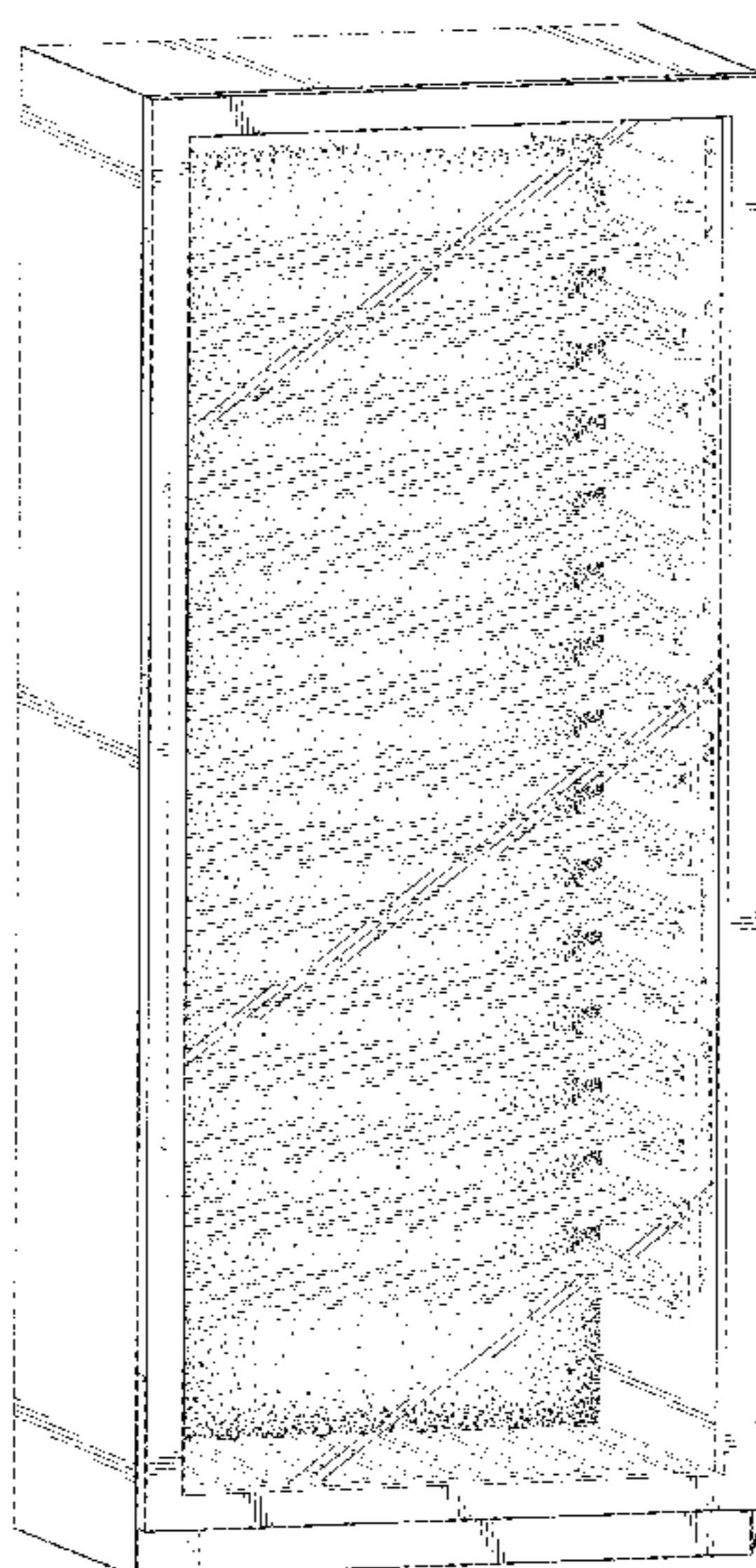

(58) **Field of Classification Search**

CPC .. F25D 11/00; F25D 17/065; F25D 2325/022;
 F25D 23/069; F25D 25/025; F25D 11/02;
 F25D 17/062; F25D 21/12; F25D 21/125;
 F25D 21/14; F25D 2317/061; F25D
 2317/067; F25D 2323/021; F25D
 2323/024; F25D 23/028; F25D 23/04;
 F25D 23/066; F25D 23/085; F25D
 23/087; F25D 23/126; F25D 2400/02;
 F25D 2400/06; F25D 2400/361; F25D
 2400/40; F25D 25/005; F25D 25/02;
 F25D 2600/02; F25D 2700/02; F25D
 2700/12; F25D 2700/121; F25D 2700/14;
 F25D 29/00

See application file for complete search history.

D651,221 S	12/2011	Voron et al.	
D652,064 S	1/2012	Voron et al.	
D659,724 S *	5/2012	Wolfe	D15/79
D671,574 S	11/2012	Jafa et al.	
D671,576 S	11/2012	Jafa et al.	
D692,467 S	10/2013	Brenneis et al.	
D726,455 S	4/2015	Collini	
D745,580 S	12/2015	Miller et al.	
D757,127 S *	5/2016	Rautavuori	D15/79
D762,741 S *	8/2016	Galiatsis	D15/81
D765,151 S	8/2016	Park et al.	
D776,726 S	1/2017	Mauffette	
D778,353 S *	2/2017	Hamayde	D18/34.1
D794,684 S *	8/2017	Mauffette	D15/81
D795,344 S *	8/2017	Cenzano	D19/32
D818,787 S *	5/2018	Kitago	D8/44
D820,329 S *	6/2018	Kanada	D15/139

(56)

References Cited

U.S. PATENT DOCUMENTS

3,224,314 A *	12/1965	Wolnez	B26D 7/22 83/522.26
D244,019 S	4/1977	Brown	
4,299,575 A *	11/1981	Carrow	B60Q 1/26 362/543
4,334,446 A *	6/1982	Field	B23B 29/043 407/40
D271,107 S	10/1983	Trulsake	
4,693,535 A *	9/1987	Frode	H01M 2/24 429/160
D386,502 S *	11/1997	Sholl	D15/79
D478,601 S	8/2003	Becke	
D512,081 S	11/2005	Chang	
D519,133 S *	4/2006	Chang	D15/81
D604,340 S	11/2009	Kim et al.	
D630,230 S	1/2011	Yang	
D630,231 S	1/2011	Yang	
D633,532 S *	3/2011	Horn	D15/81

OTHER PUBLICATIONS

Vinotemp 187-Bottle Single-Zone Wine Cooler (retrieved May 17, 2019).
 Private Reserve Series 41-Bottle Commercial 54 Single-Zone Wine Cooler (retrieved May 17, 2019).
 Private Reserve Series 141-Bottle Commercial 168 Single-Zone Wine Cooler (retrieved May 17, 2019).
 Private Reserve Series 141-Bottle Commercial 168 Single-Zone Wine Cooler—Scratch n Dent (retrieved May 17, 2019).
 Private Reserve Series 141-Bottle Commercial 168 Single-Zone Wine Cooler (Left Hinge)—Scratch n Dent (retrieved May 17, 2019).
 Private Reserve Series 141-Bottle Commercial 168 Single-Zone Wine Cooler (Left Hinge) (retrieved May 17, 2019).
 Private Reserve Series 188-Bottle Commercial 300 Wine Cooler (retrieved May 17, 2019).
 Private Reserve Series 188-Bottle Commercial 300 Wine Cooler (Left Hinge) (retrieved May 17, 2019).

* cited by examiner

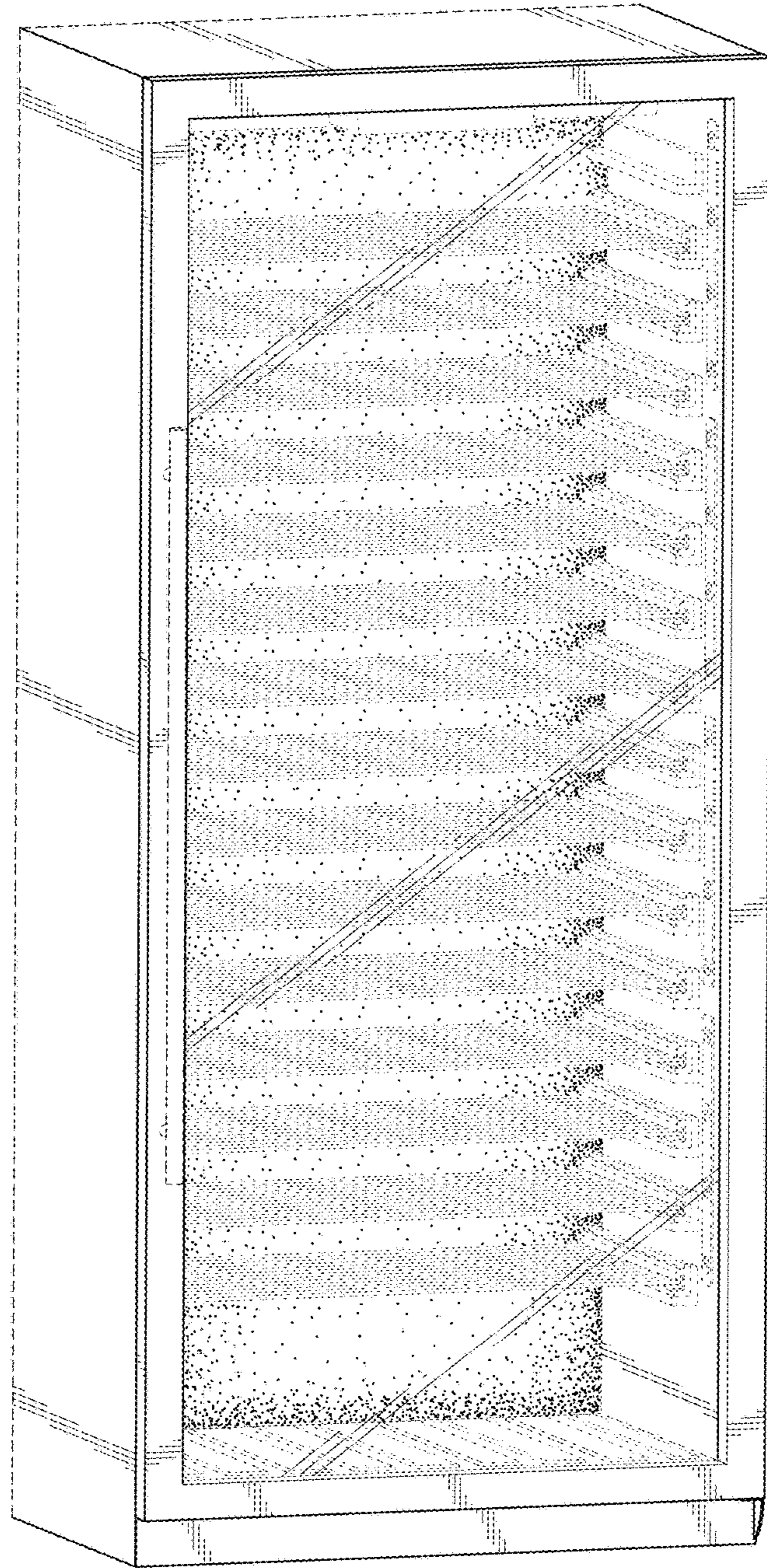

FIG. 1

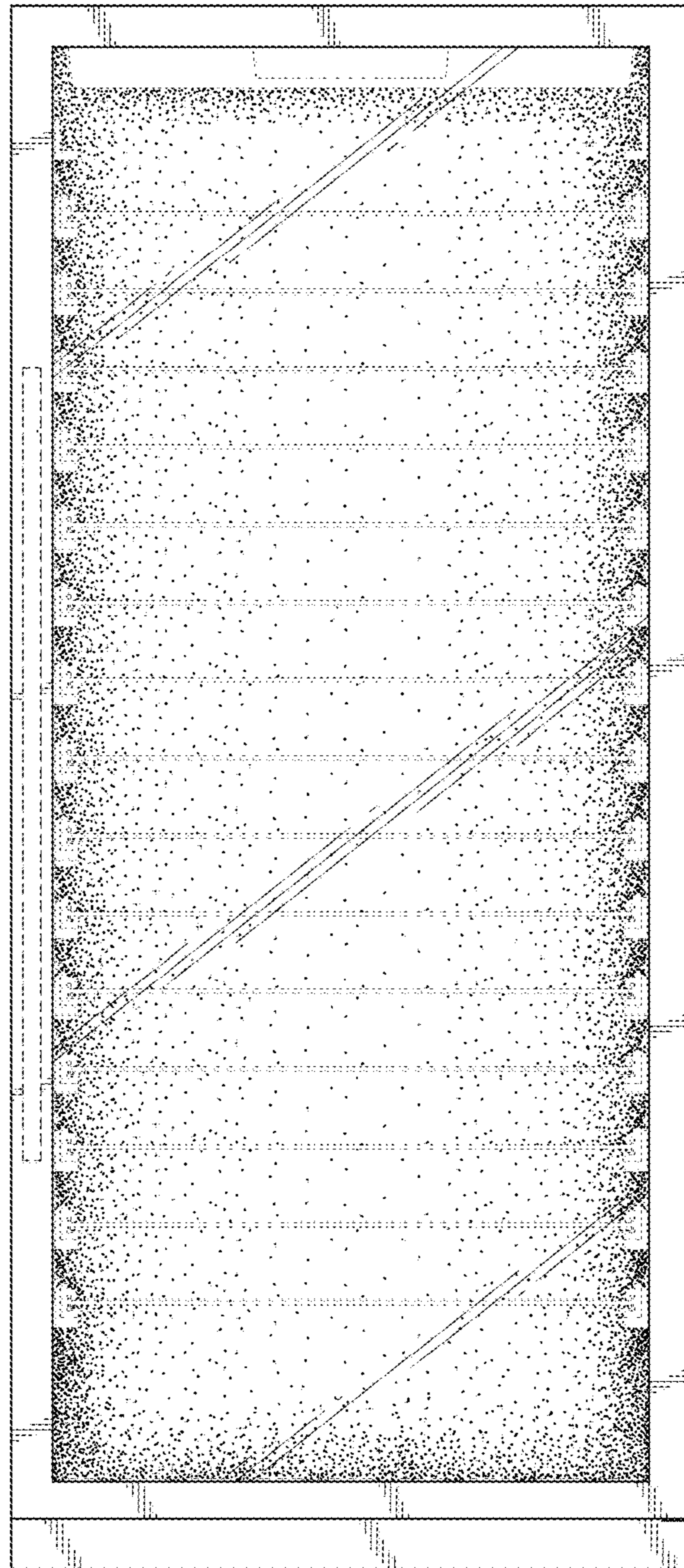

FIG. 2

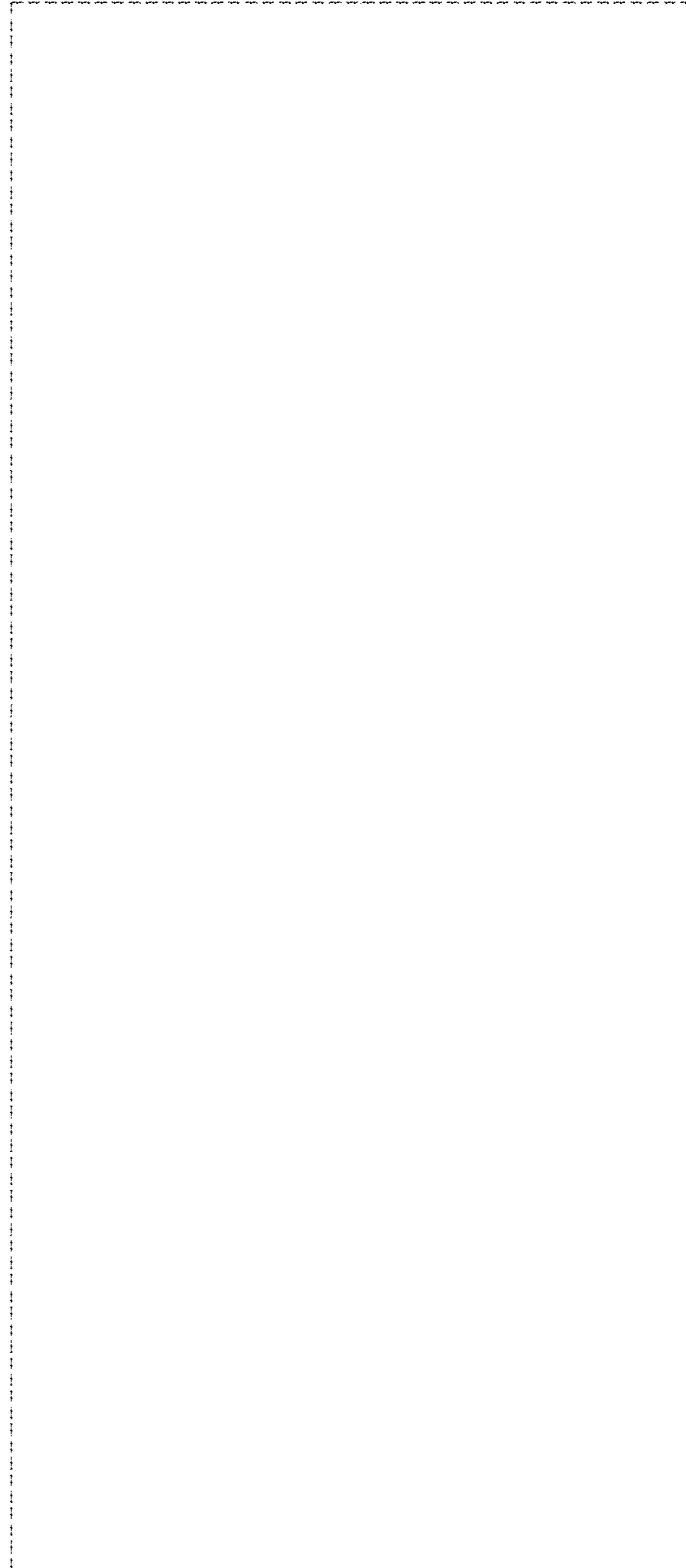

FIG. 3

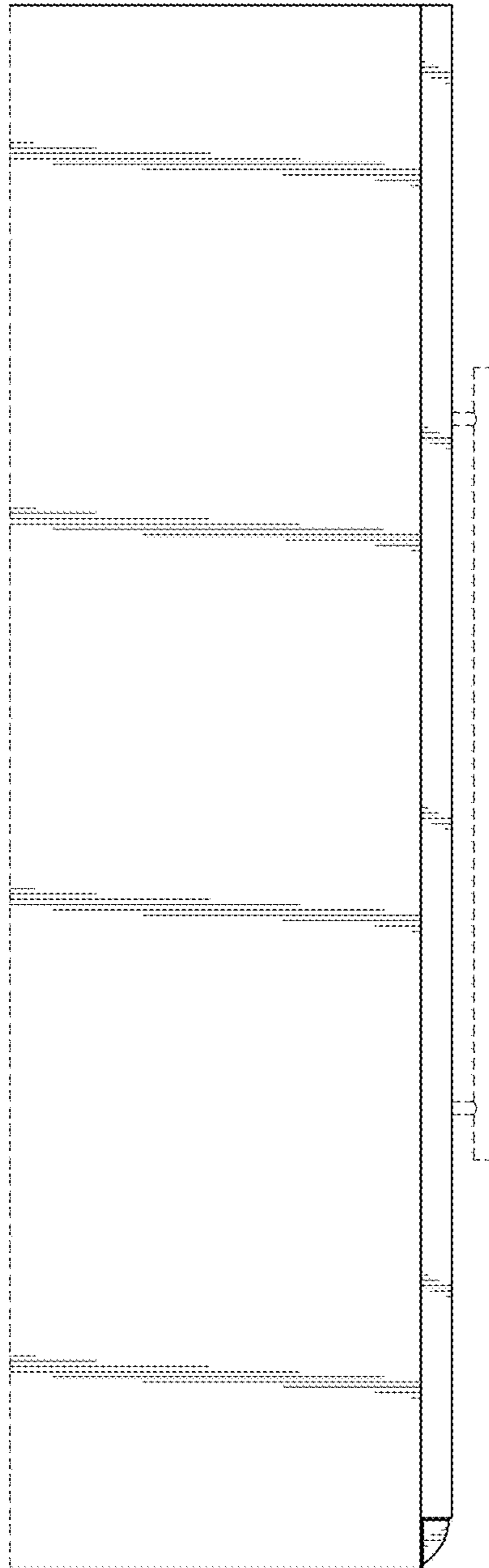

FIG. 4

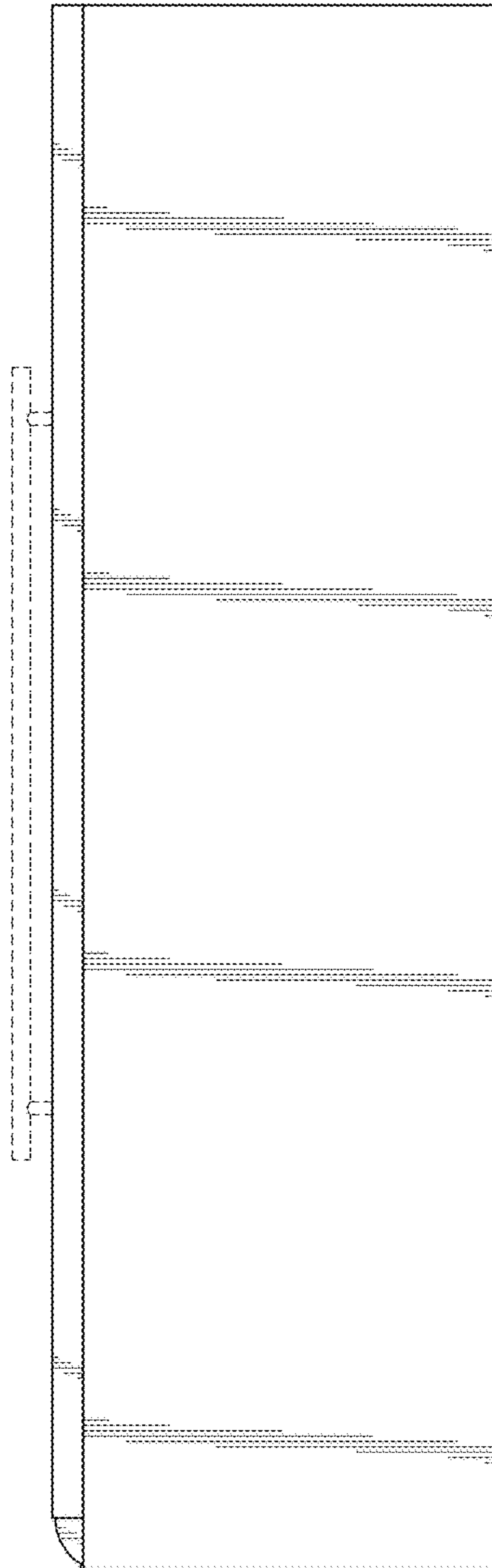

FIG. 5

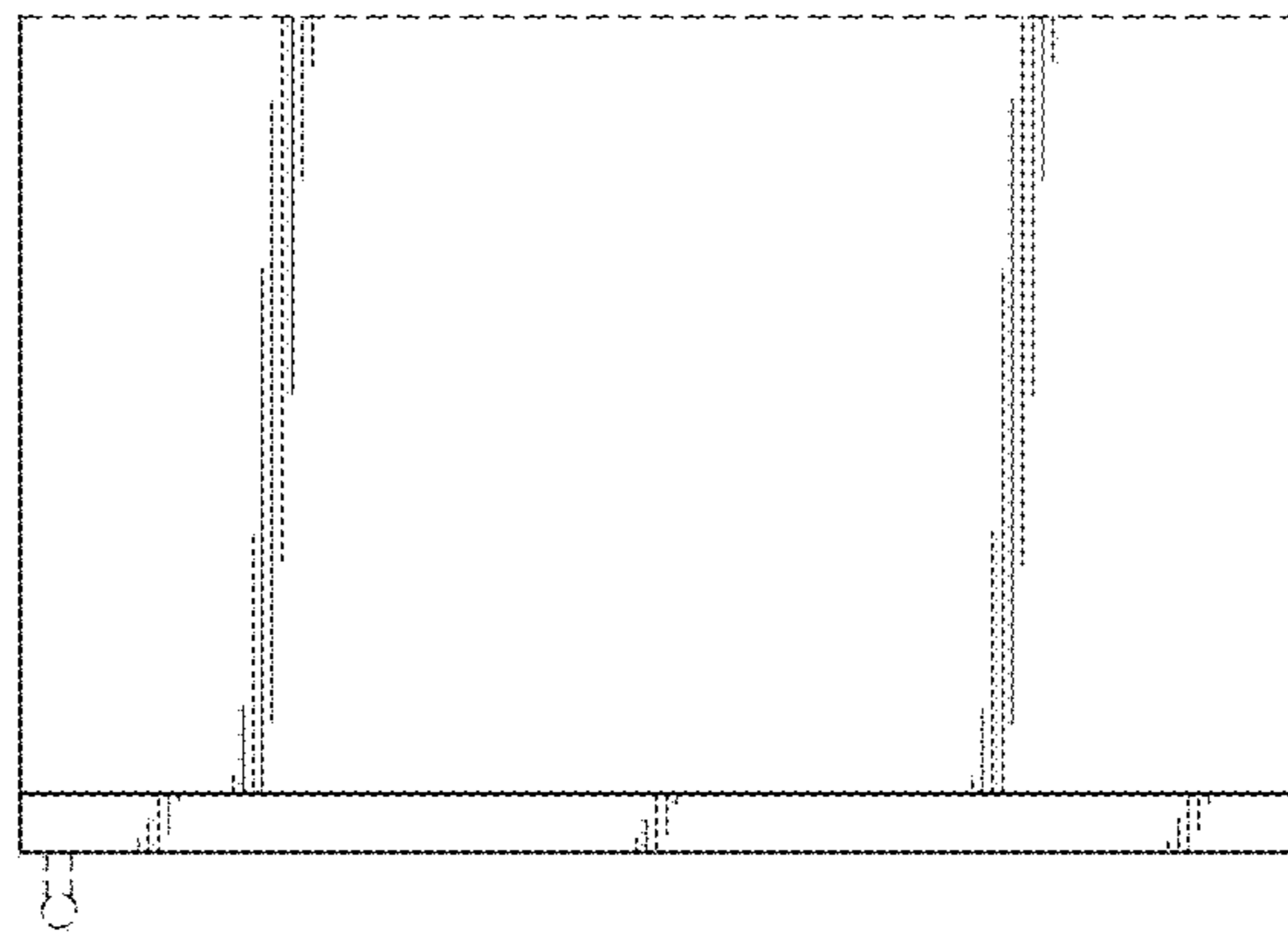

FIG. 6

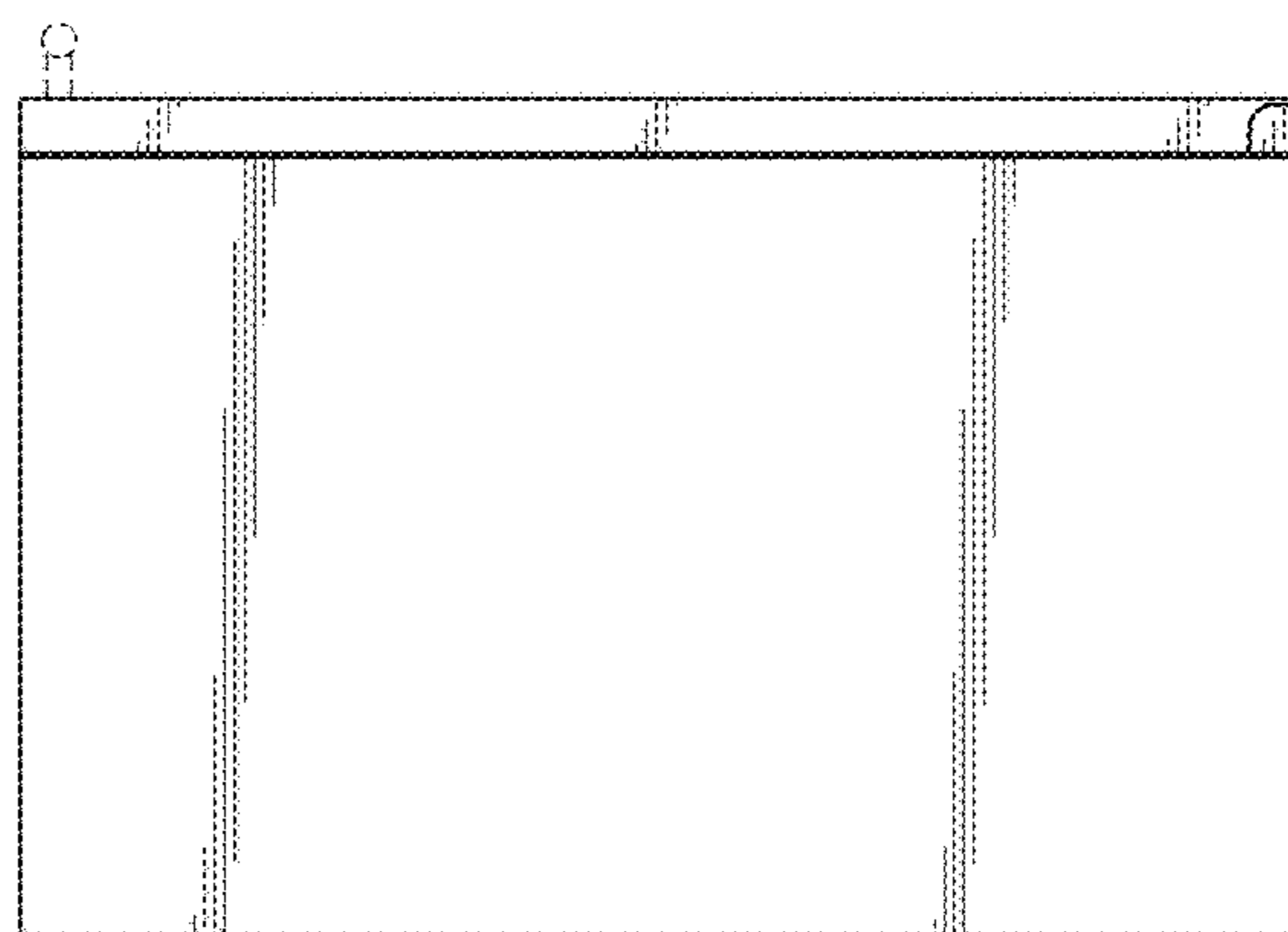

FIG. 7

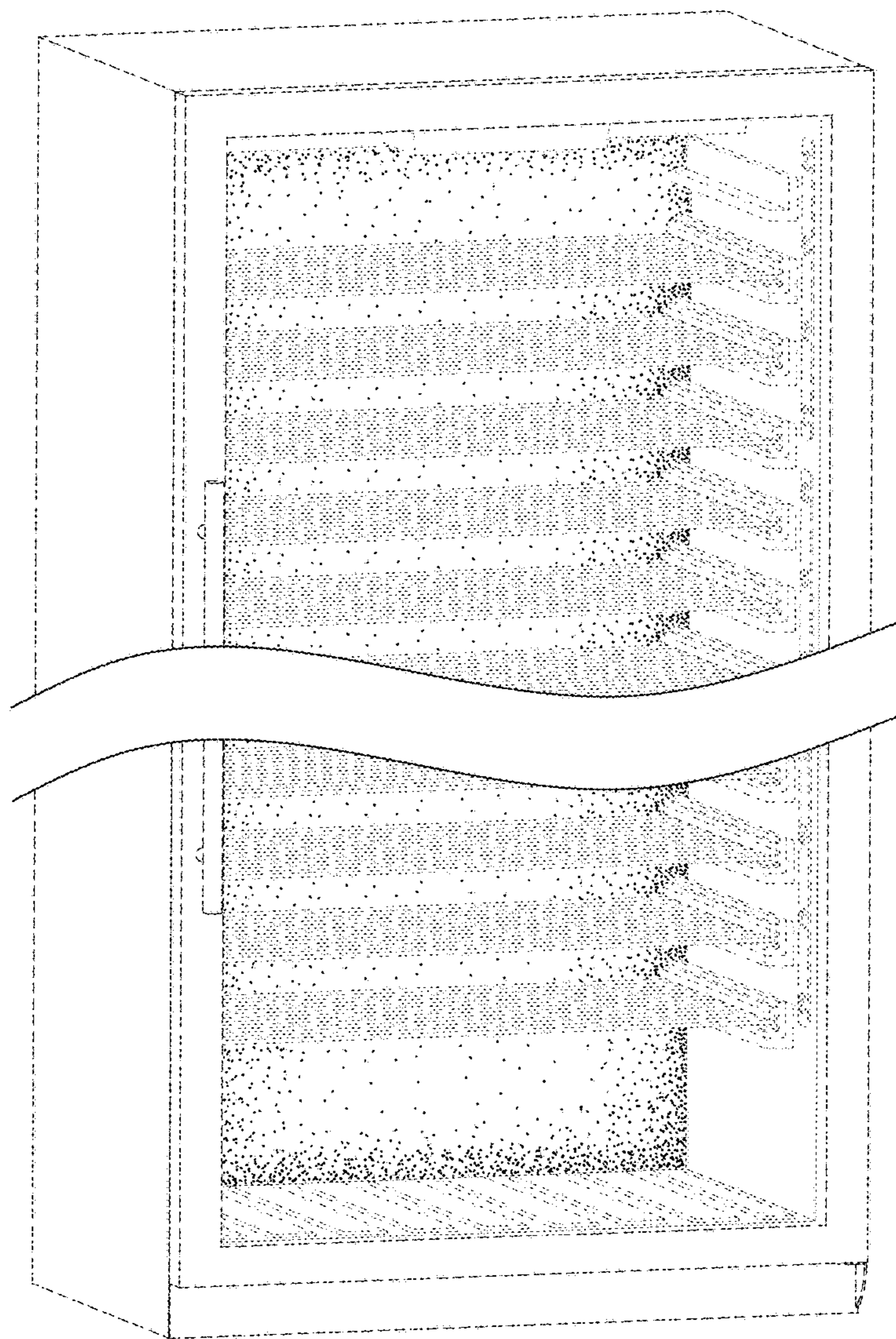

FIG. 8

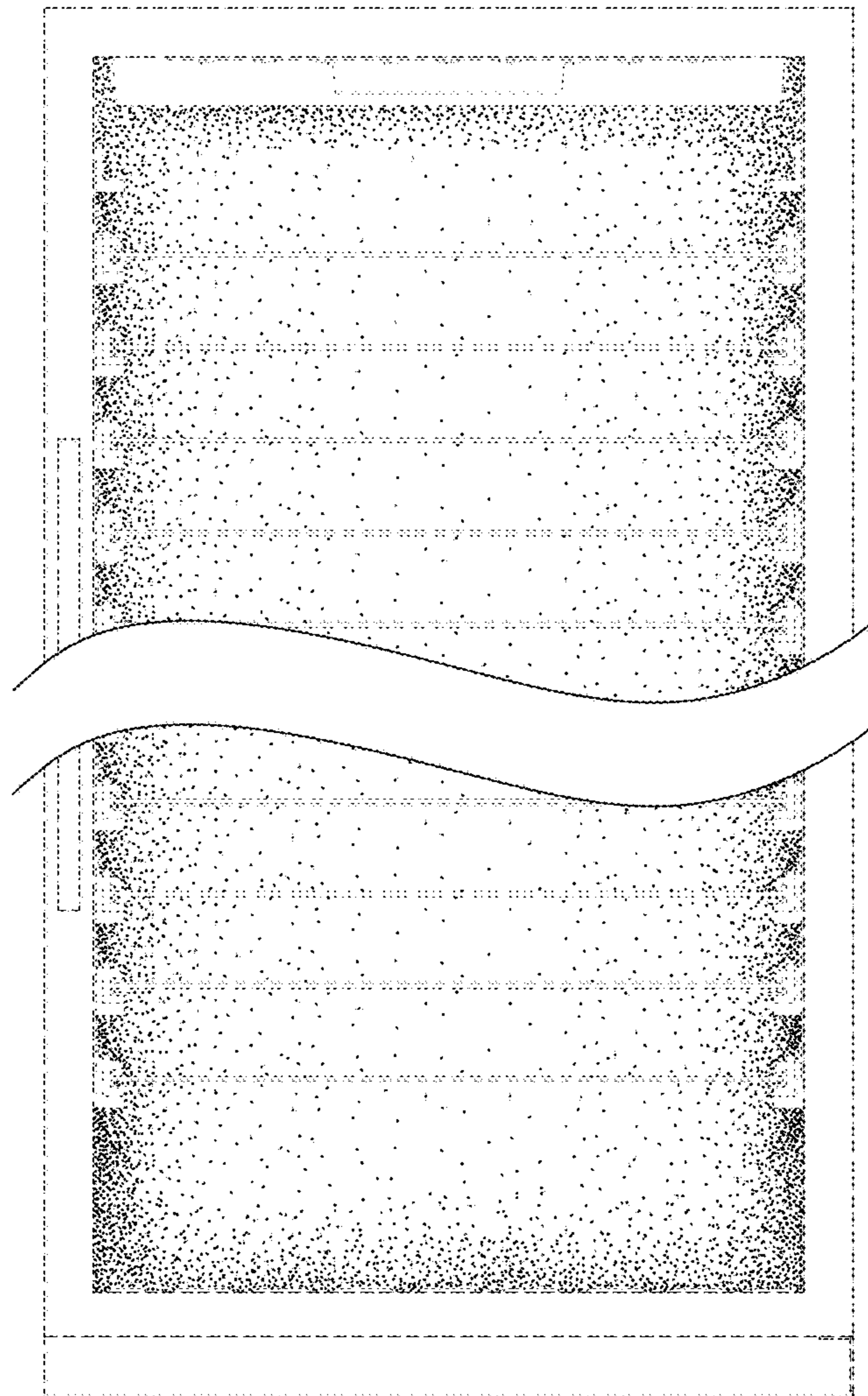

FIG. 9

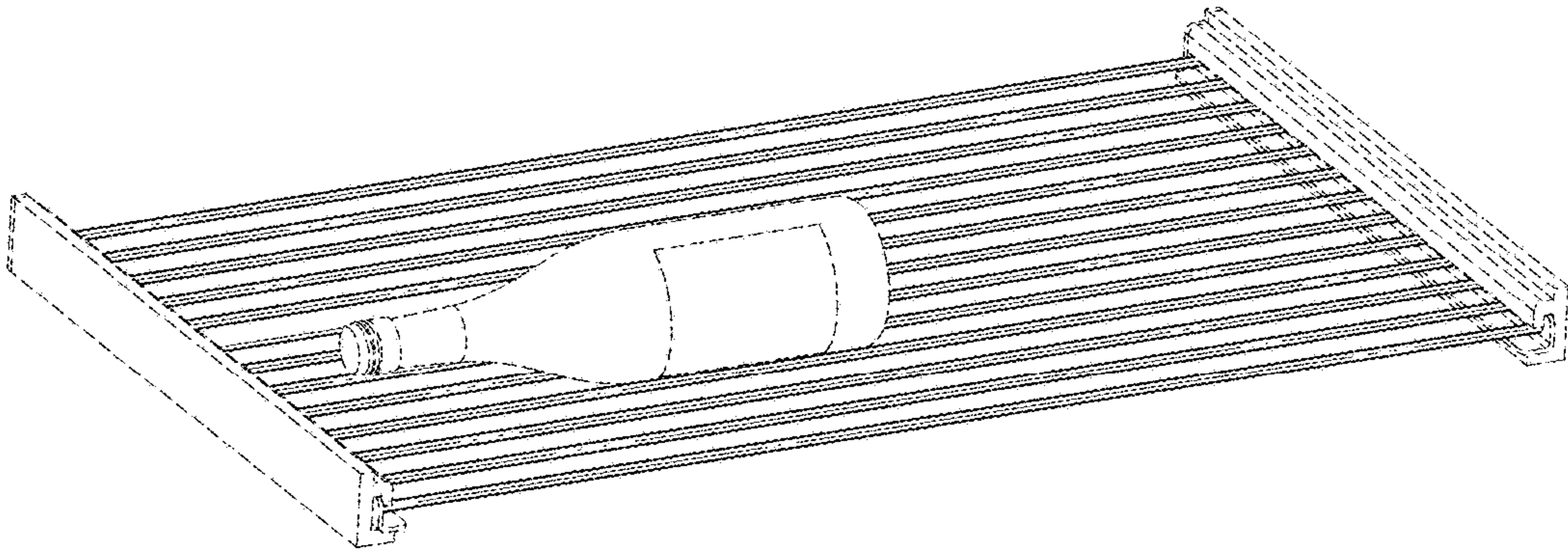

FIG. 10

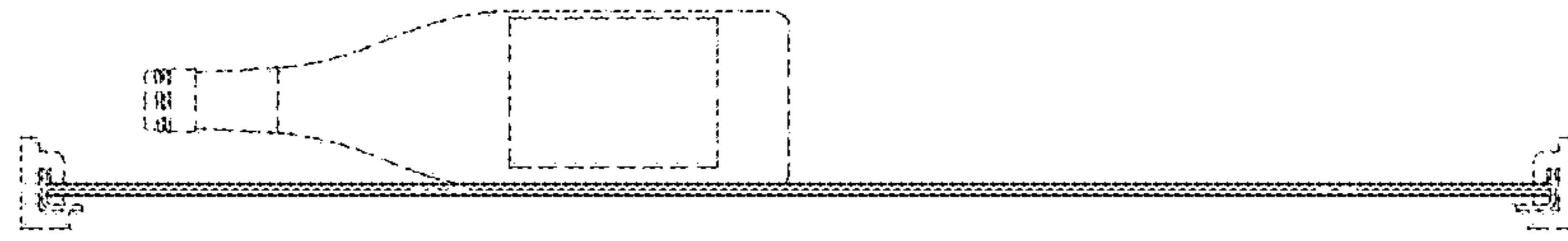

FIG. 11

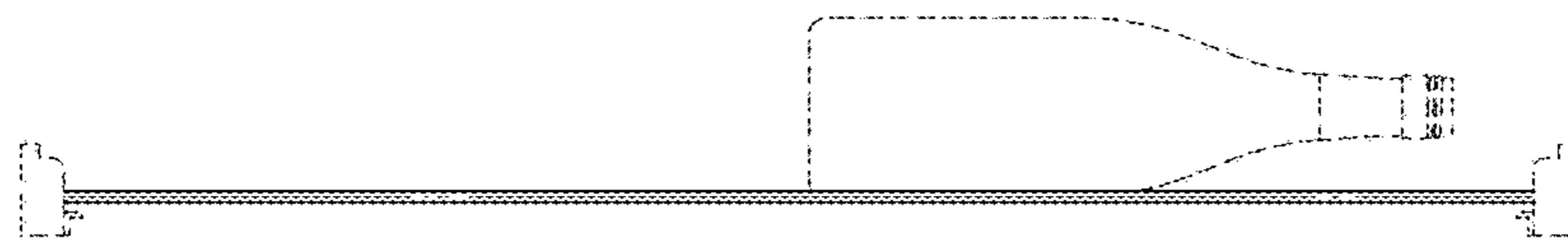

FIG. 12

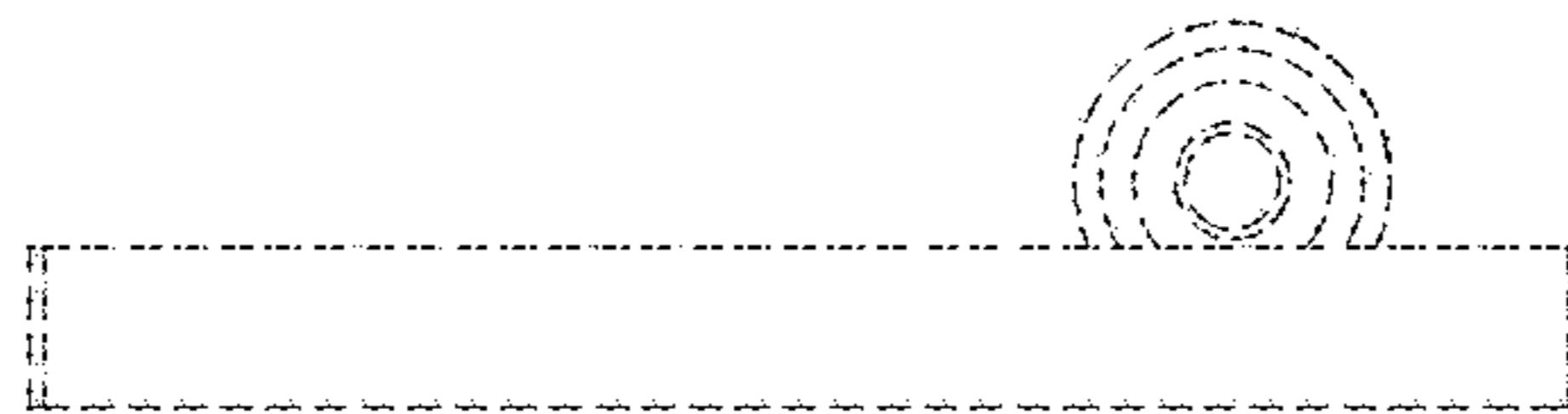

FIG. 13

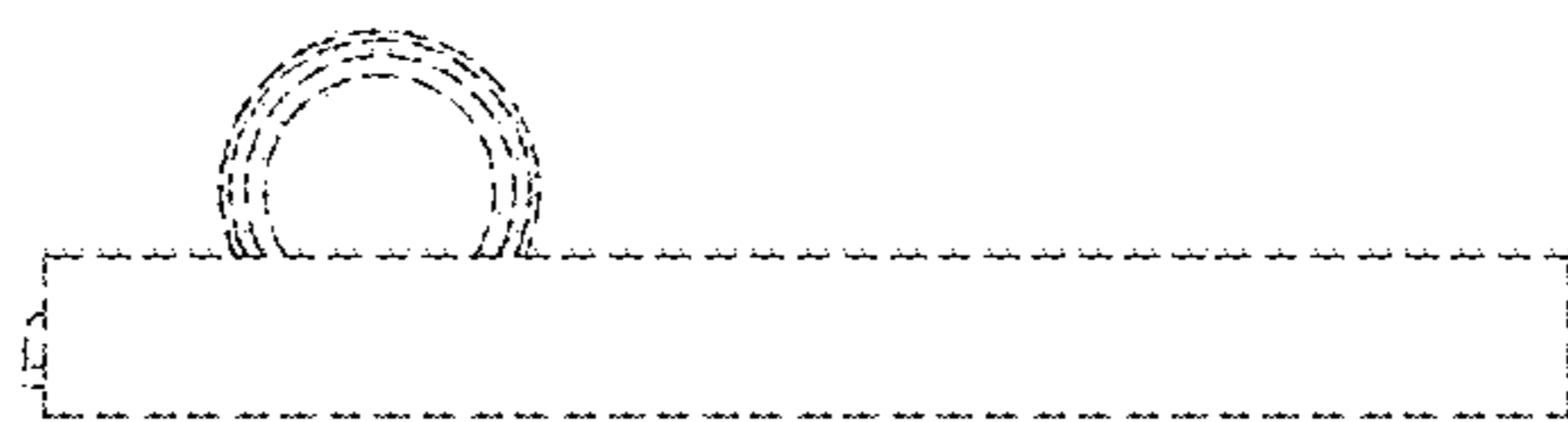

FIG. 14

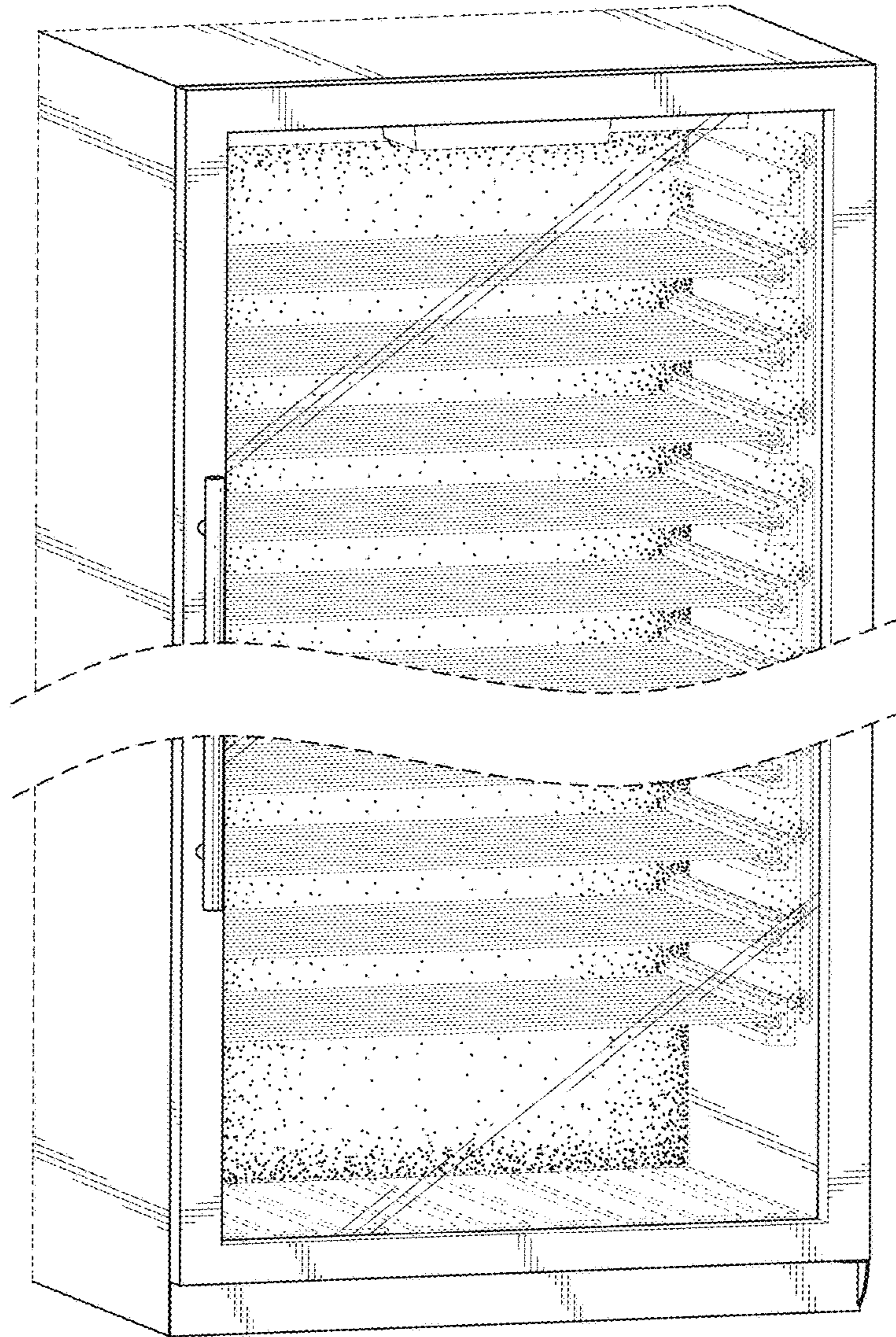

FIG. 15

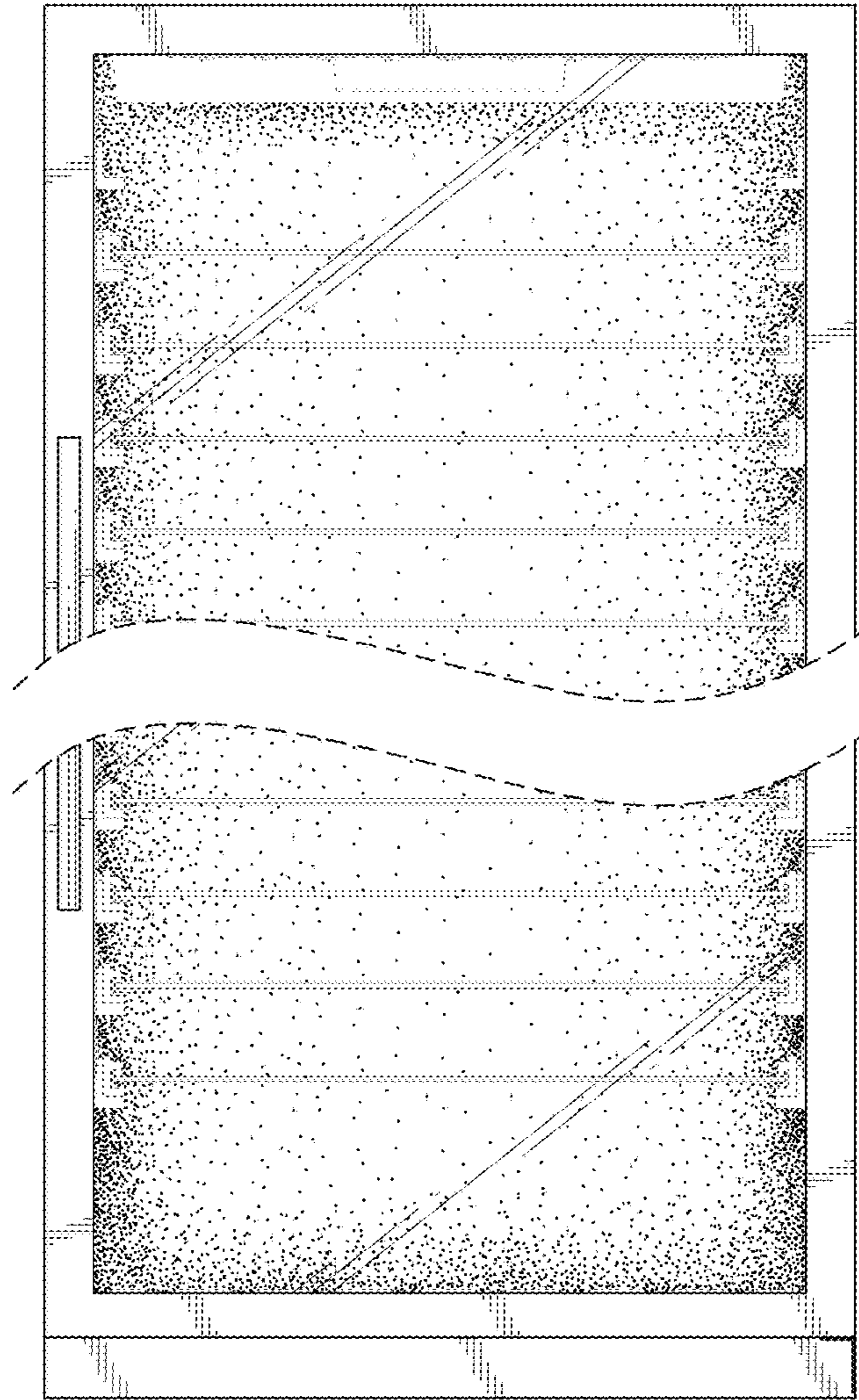

FIG. 16

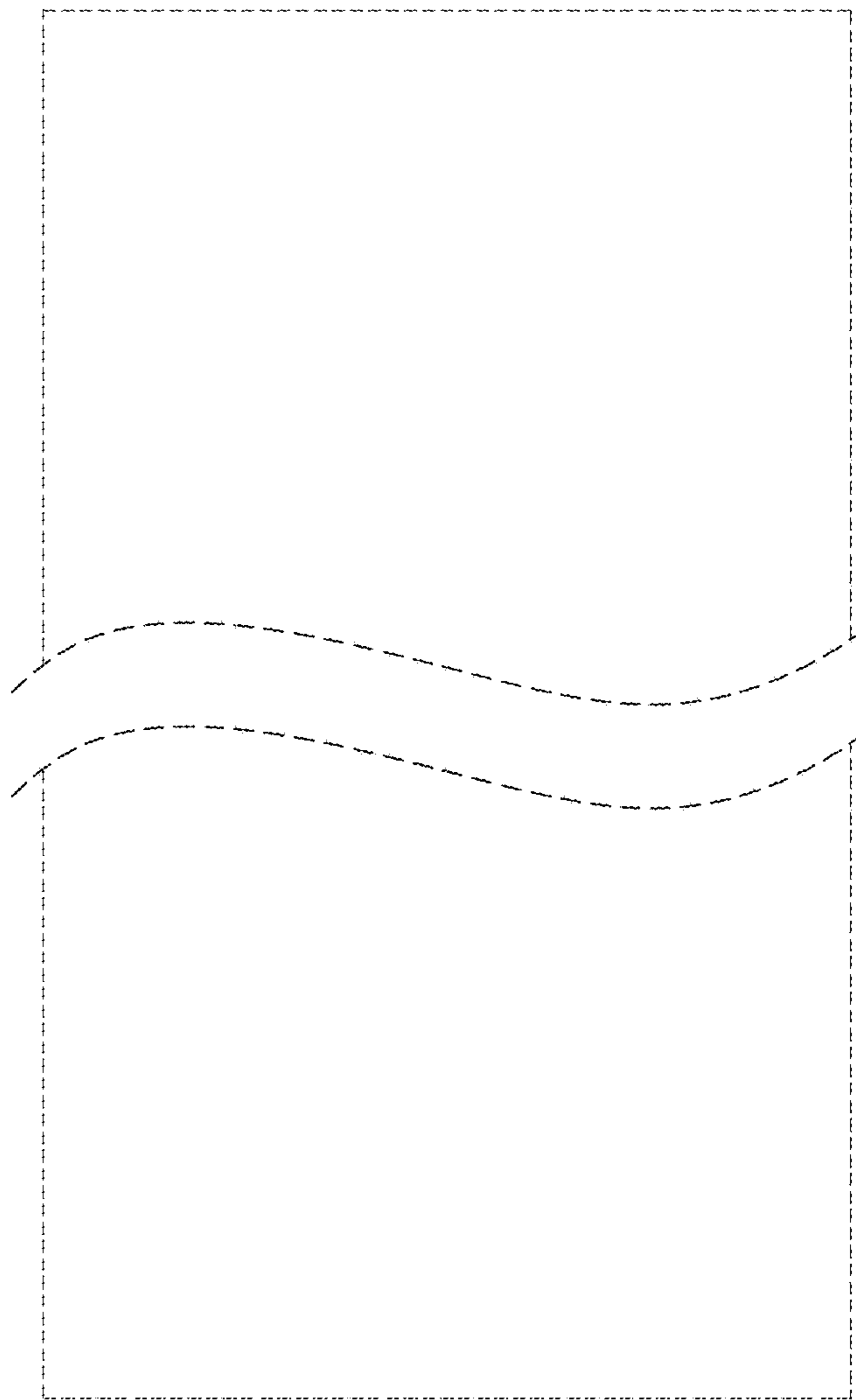

FIG. 17

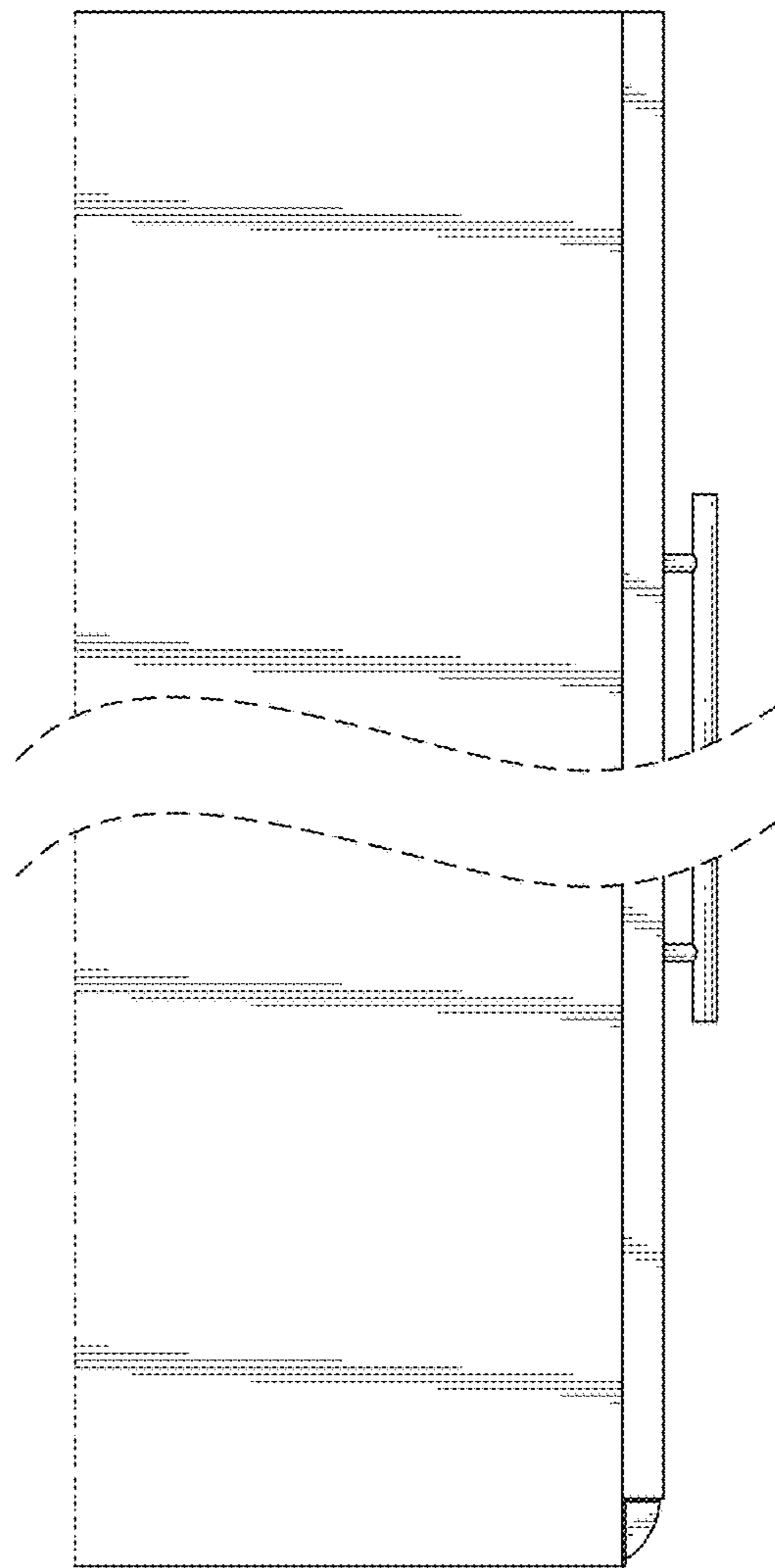

FIG. 18

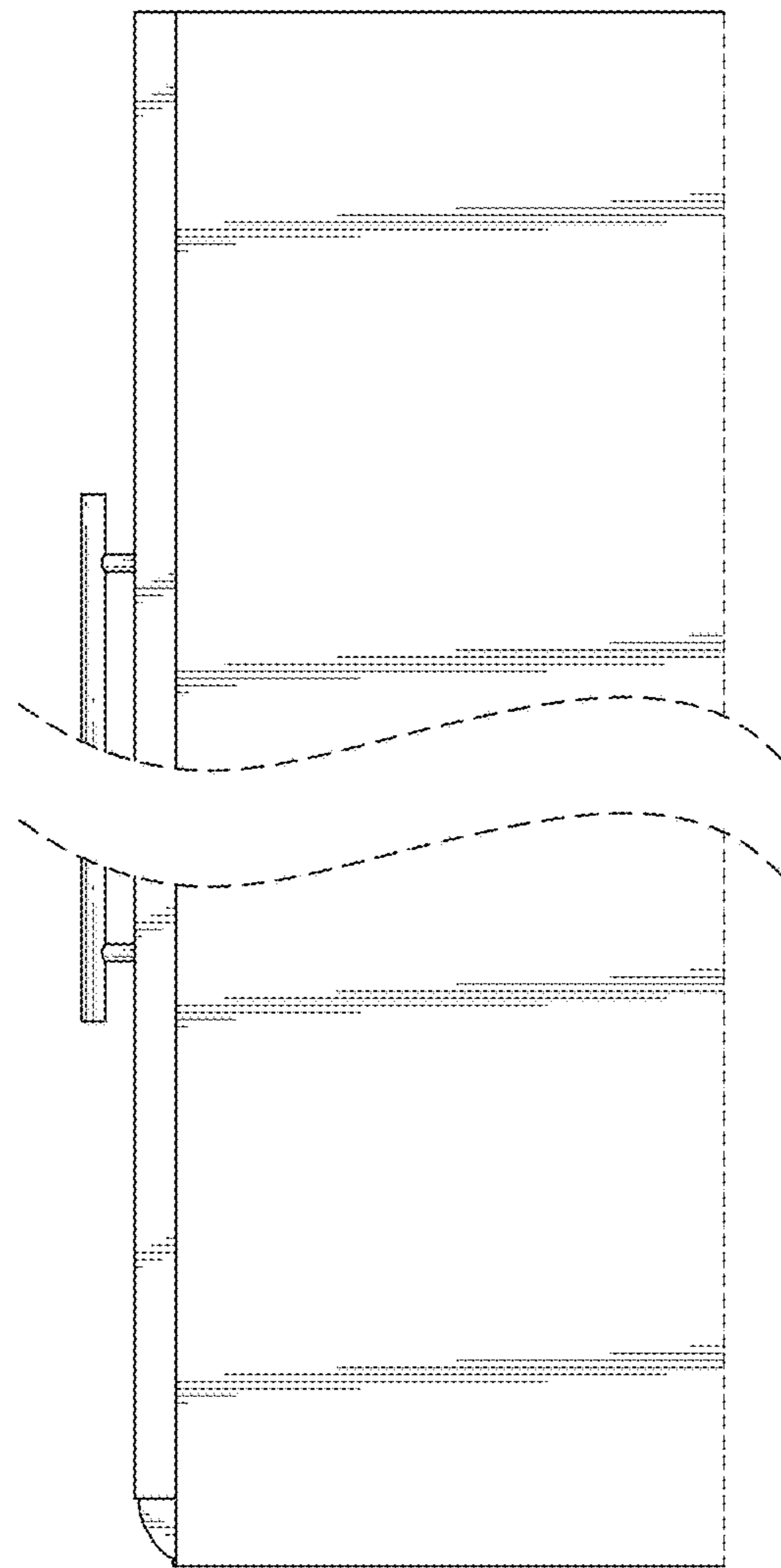

FIG. 19

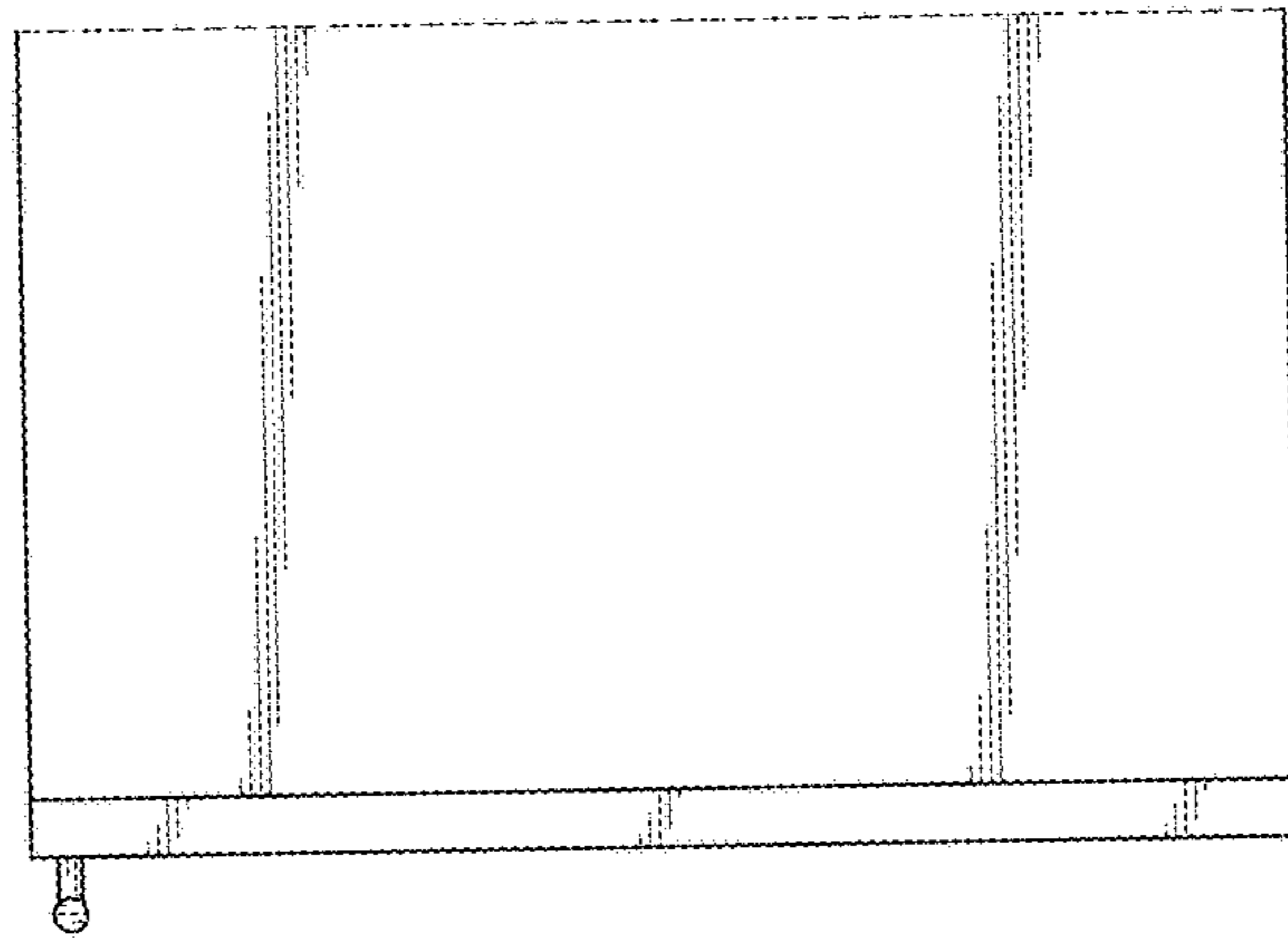

FIG. 20

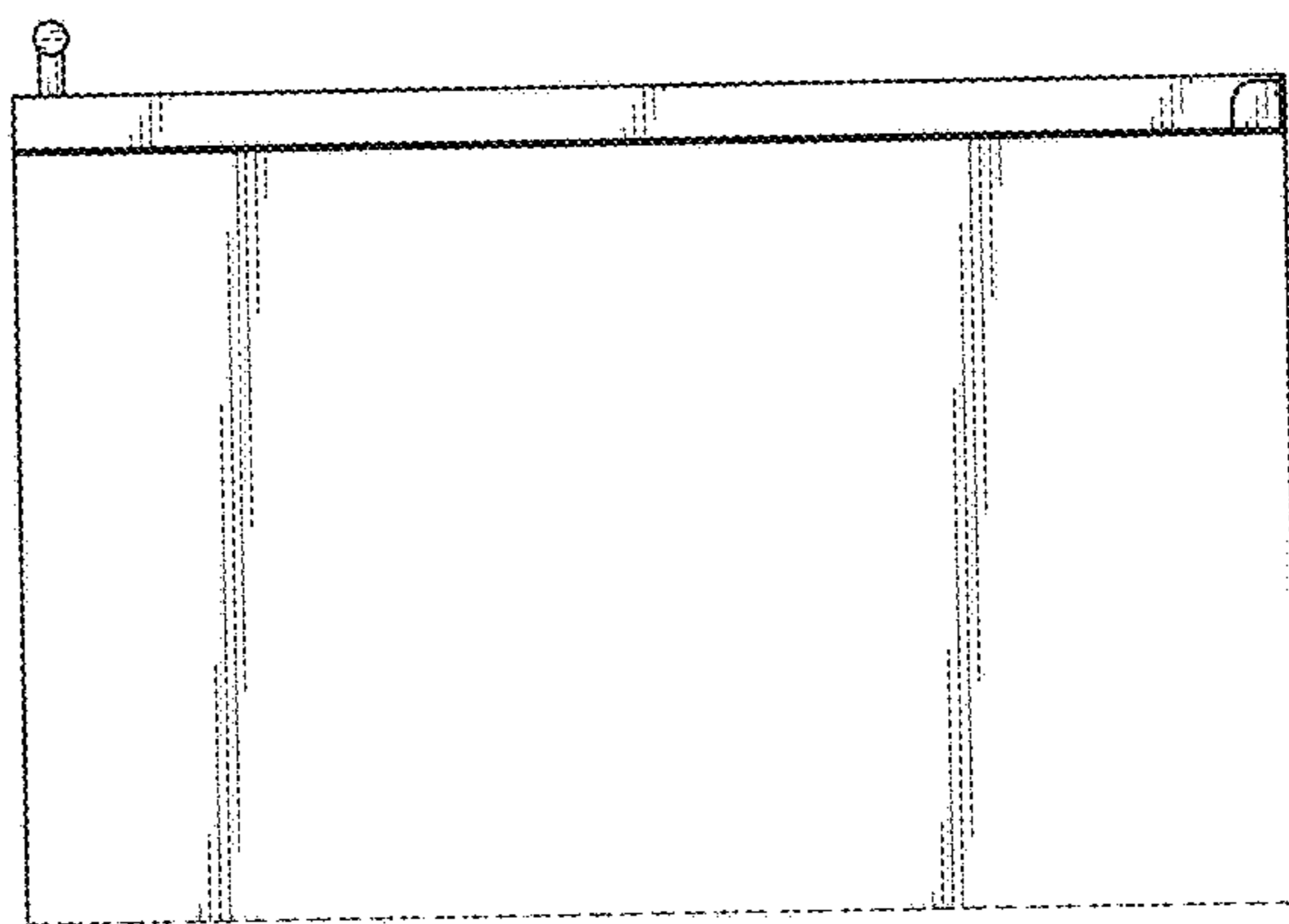

FIG. 21

UNITED STATES PATENT AND TRADEMARK OFFICE
CERTIFICATE OF CORRECTION

PATENT NO. : D868,849 S
APPLICATION NO. : 29/625644
DATED : December 3, 2019
INVENTOR(S) : India Hynes

Page 1 of 20

It is certified that error appears in the above-identified patent and that said Letters Patent is hereby corrected as shown below:

Delete the title page and replace with attached title page consisting of corrected figures 1-14 descriptions, number of drawing sheets, and illustrative figure.

Delete Drawing Sheets 1-16 and replace with the attached Drawing Sheets 1-18 consisting of corrected FIGS. 1-14.

Signed and Sealed this
Fifth Day of May, 2020

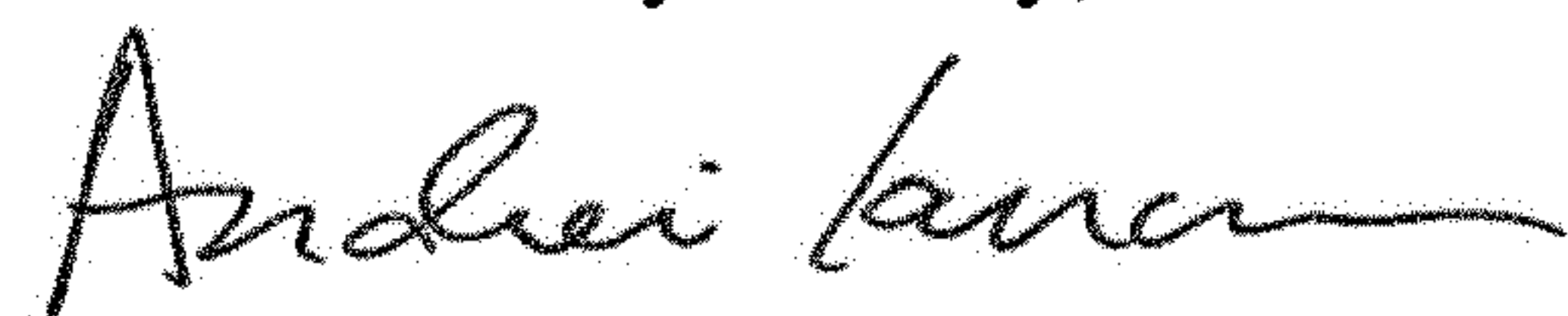

Andrei Iancu
Director of the United States Patent and Trademark Office

(12) **United States Design Patent** (10) **Patent No.:** **US D868,849 S**
Hynes (45) **Date of Patent:** **** Dec. 3, 2019**

(54) **APPLIANCE WITH BACKLIT FEATURE**
 (71) Applicant: **Vinotemp International Corporation**, Irvine, CA (US)
 (72) Inventor: **India Hynes**, Laguna Beach, CA (US)
 (73) Assignee: **VINOTEMP INTERNATIONAL CORPORATION**, Irvine, CA (US)
 (**) Term: **15 Years**
 (21) Appl. No.: **29/625,644**
 (22) Filed: **Nov. 10, 2017**
 (51) **LOC (12) Cl.** **15-07**
 (52) **U.S. Cl.**
 USPC **D15/81**
 (58) **Field of Classification Search**
 USPC **D15/79-91**
 (Continued)

(56) **References Cited**
U.S. PATENT DOCUMENTS
 1,847,147 A * 3/1932 Thomas, Jr. H02G 3/06
 174/68.3
 2,250,156 A * 7/1941 Ferguson H01R 4/026
 174/84 R
 (Continued)

OTHER PUBLICATIONS
 Office Action, dated May 1, 2019, in U.S. Appl. No. 87/404,929.
 (Continued)
Primary Examiner — Khawaja Anwar
 (74) *Attorney, Agent, or Firm* — Knobbe, Martens, Olson & Bear, LLP

(57) **CLAIM**
 The ornamental design for an appliance with backlit feature or portion thereof, as shown and described.

DESCRIPTION
 FIG. 1 is a perspective view of an appliance with backlit feature;
 FIG. 2 is a front view thereof;
 FIG. 3 is a rear view thereof;
 FIG. 4 is a left side view thereof;
 FIG. 5 is a right side view thereof;
 FIG. 6 is a top view thereof;
 FIG. 7 is a bottom view thereof;
 FIG. 8 is a perspective view of the appliance with backlit feature with certain features shown in dashed lines disclaimed. In particular, the handle, the interior racks and the front light elements are disclaimed.
 FIG. 9 is a front view thereof;
 FIG. 10 is a rear view thereof;
 FIG. 11 is a left side view thereof;
 FIG. 12 is a right side view thereof;
 FIG. 13 is a top view thereof;
 FIG. 14 is a bottom view thereof;
 FIG. 15 is a perspective view of an appliance with backlit feature;
 FIG. 16 is a front view thereof;
 FIG. 17 is a rear view thereof;
 FIG. 18 is a left side view thereof;
 FIG. 19 is a right side view thereof;
 FIG. 20 is a top view thereof; and,
 FIG. 21 is a bottom view thereof.
 The broken lines in the drawings illustrate portions of the appliance with backlit feature that form no part of the claimed design. The portions between the break lines in FIGS. 15-19 represent an indeterminate length and form no part of the claimed design.
 In FIGS. 1-21, the stippling on the back panel represents the backlit feature of the appliance. As shown in FIGS. 1, 2, 8, 9, 15, and 16, the backlighting is located at a periphery of the rear interior panel of the appliance. The backlighting is brightest at the periphery and fades toward the interior of the rear panel. In FIGS. 8-14, the handle, front lighting and the interior racks are disclaimed.

1 Claim, 18 Drawing Sheets

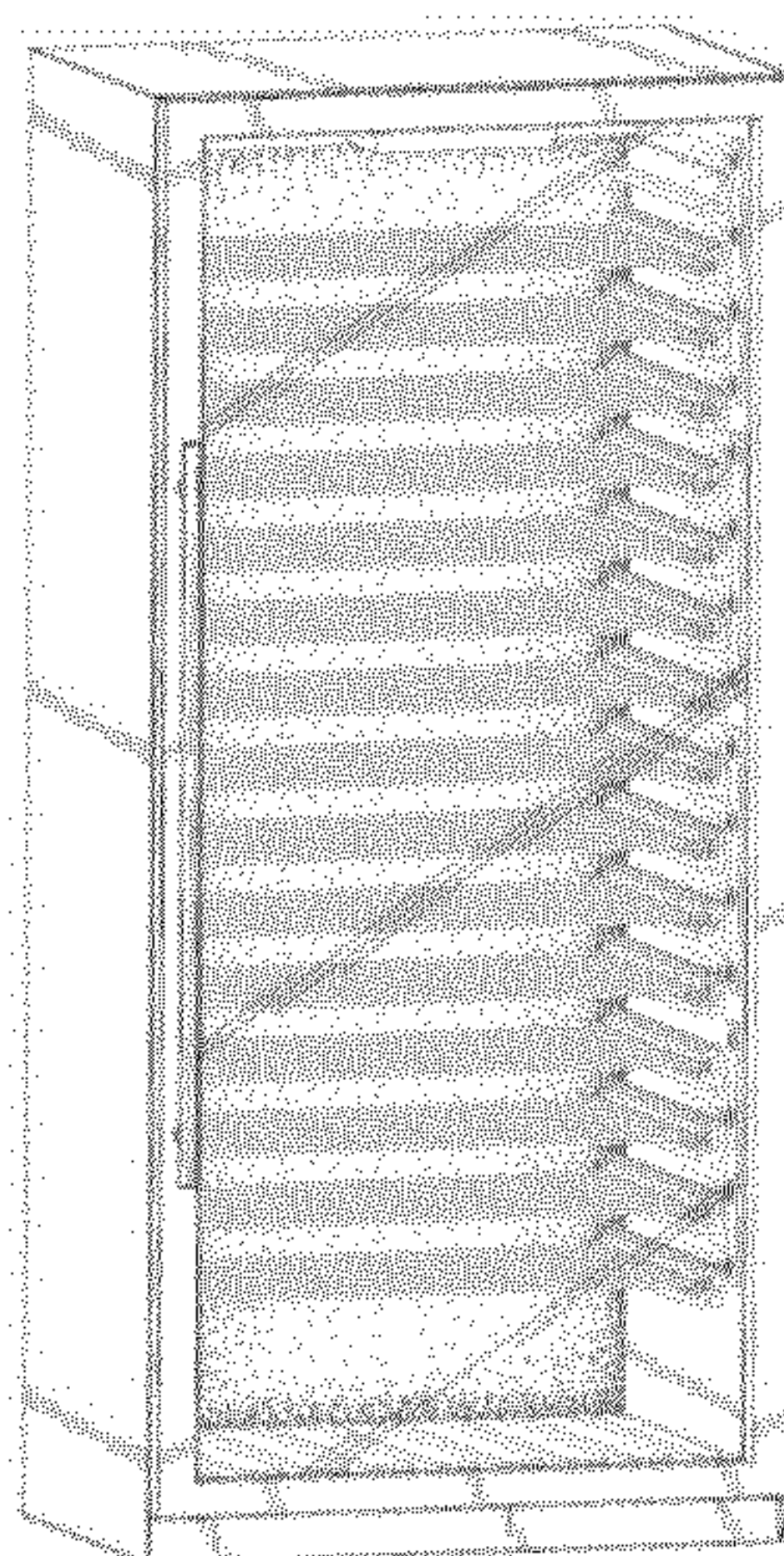

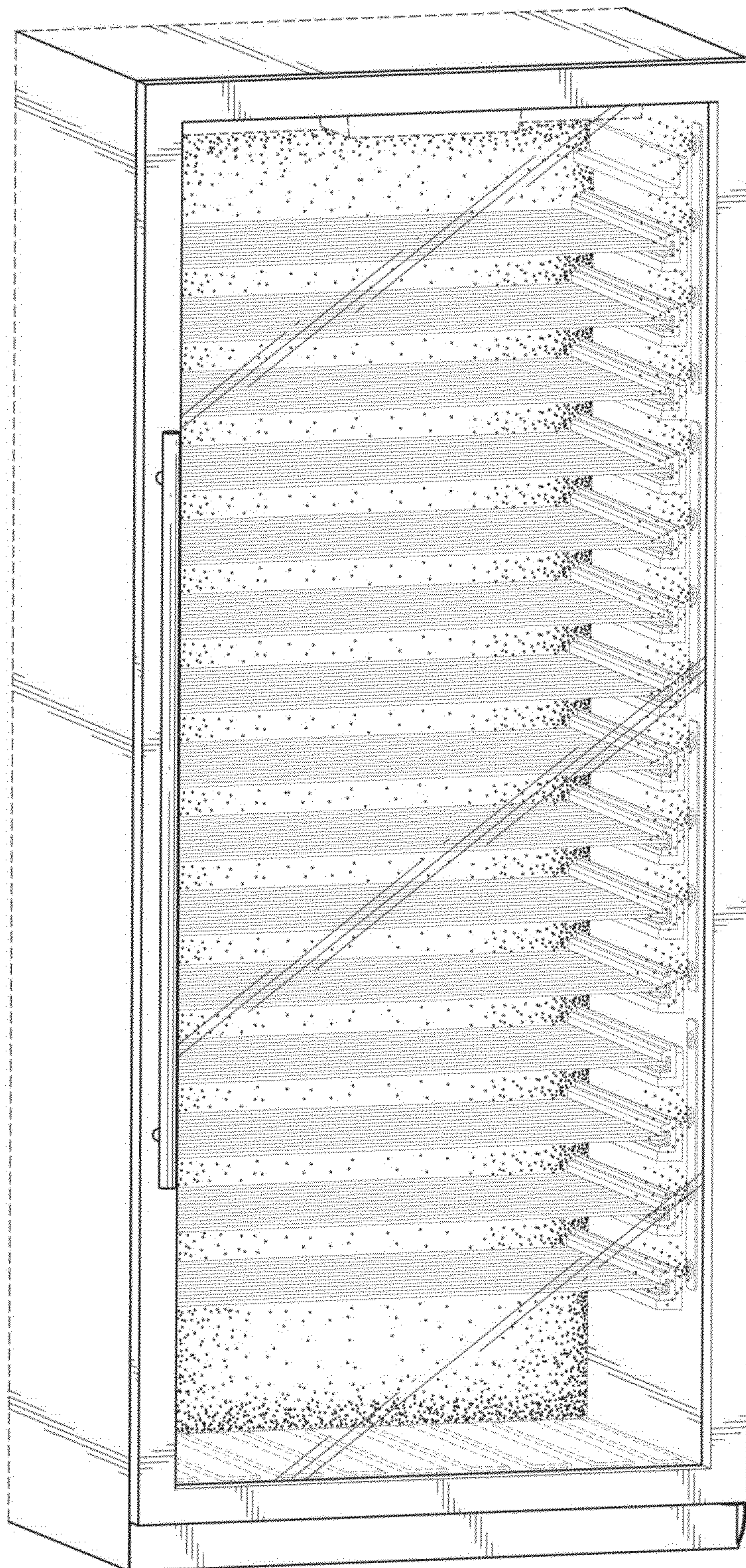

FIG. 1

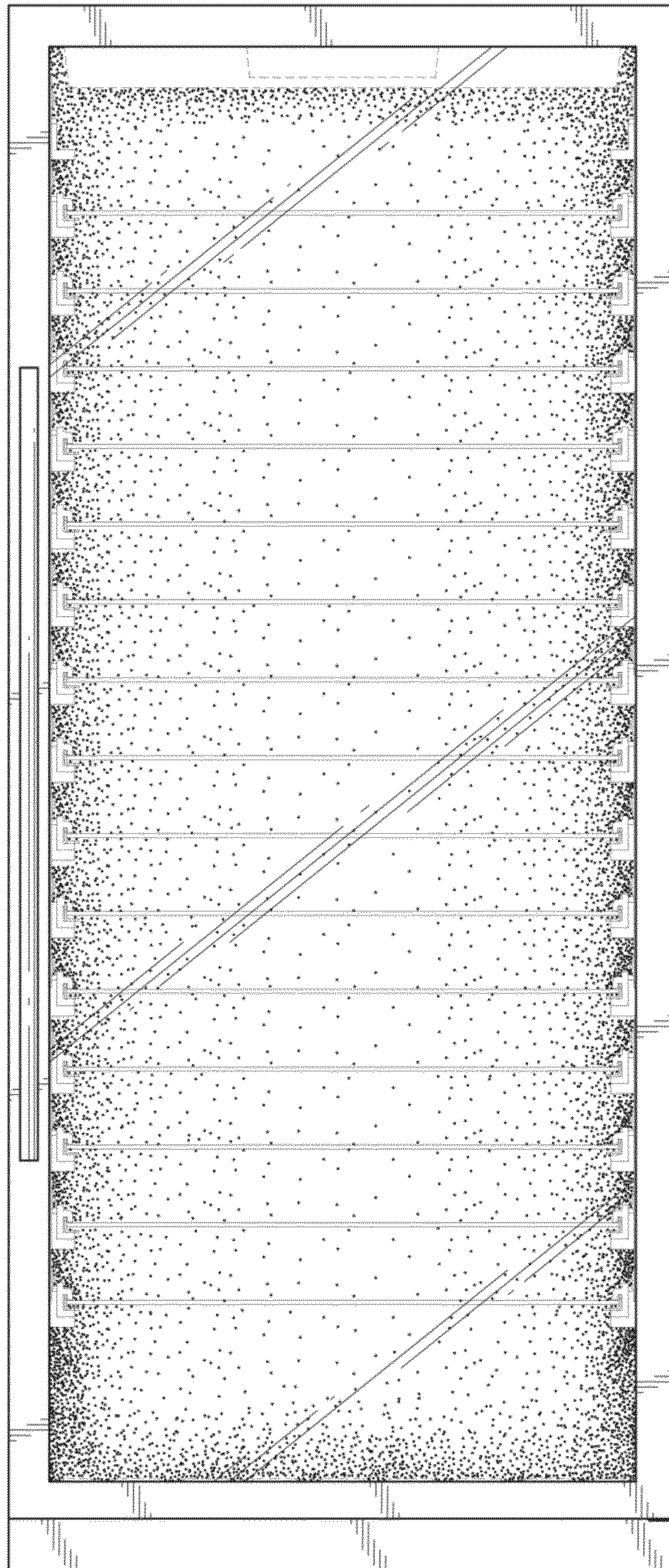

FIG. 2

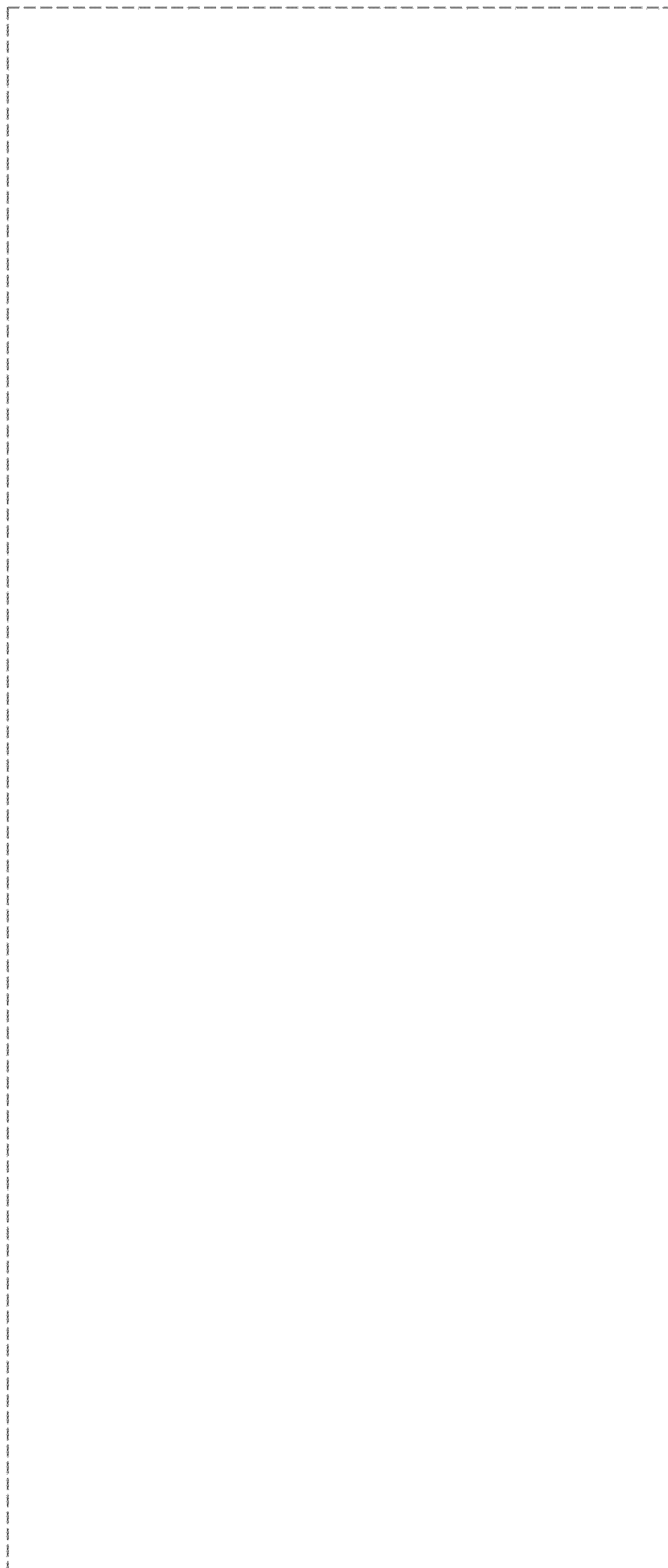

FIG. 3

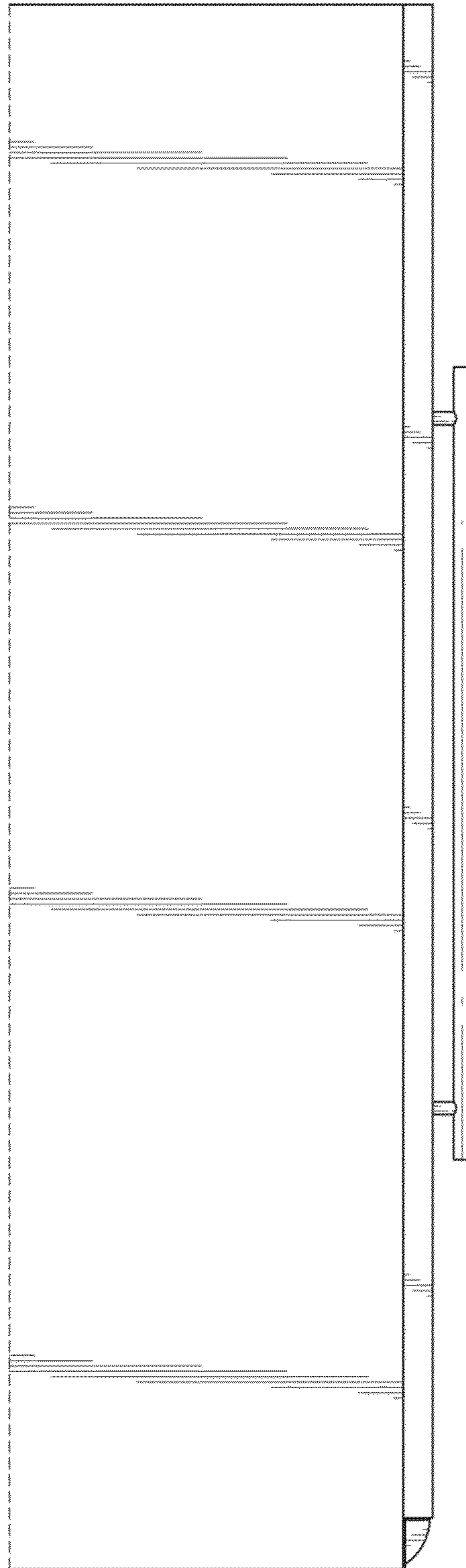

FIG. 4

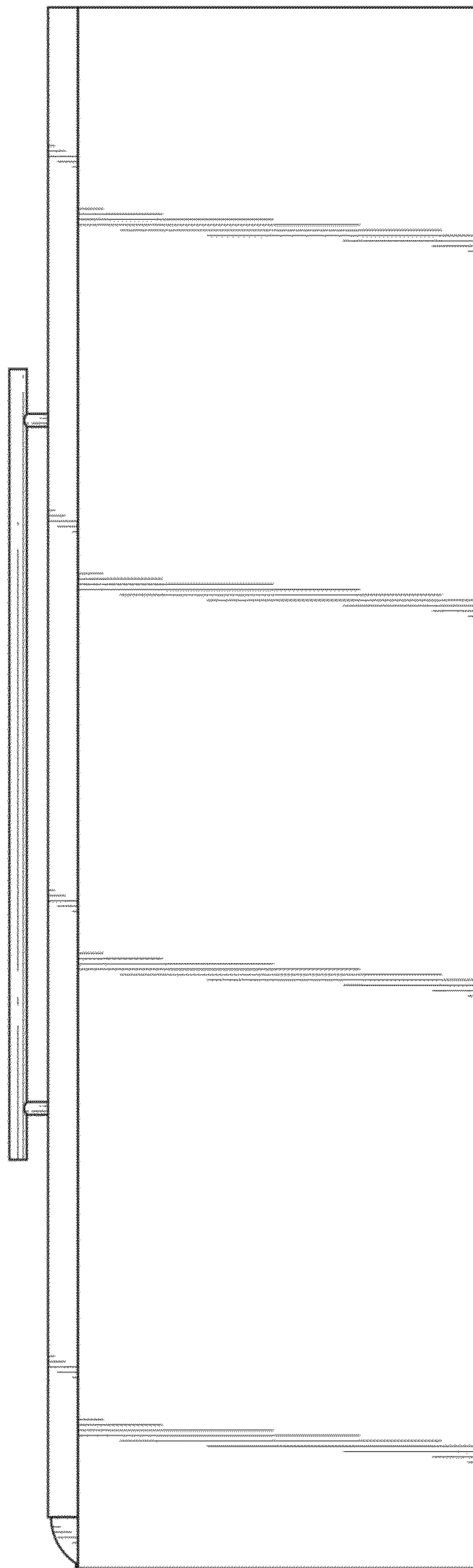

FIG. 5

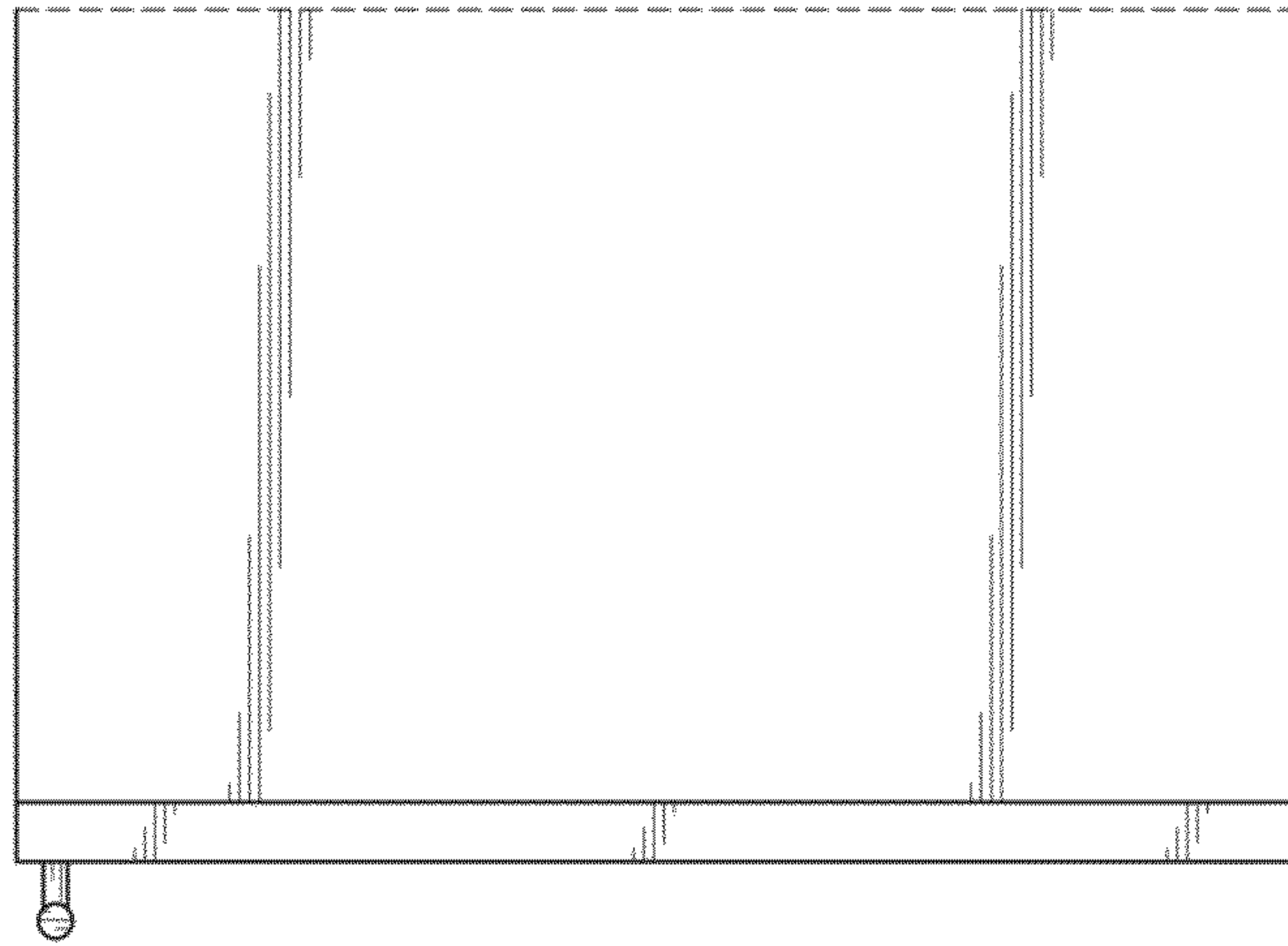

FIG. 6

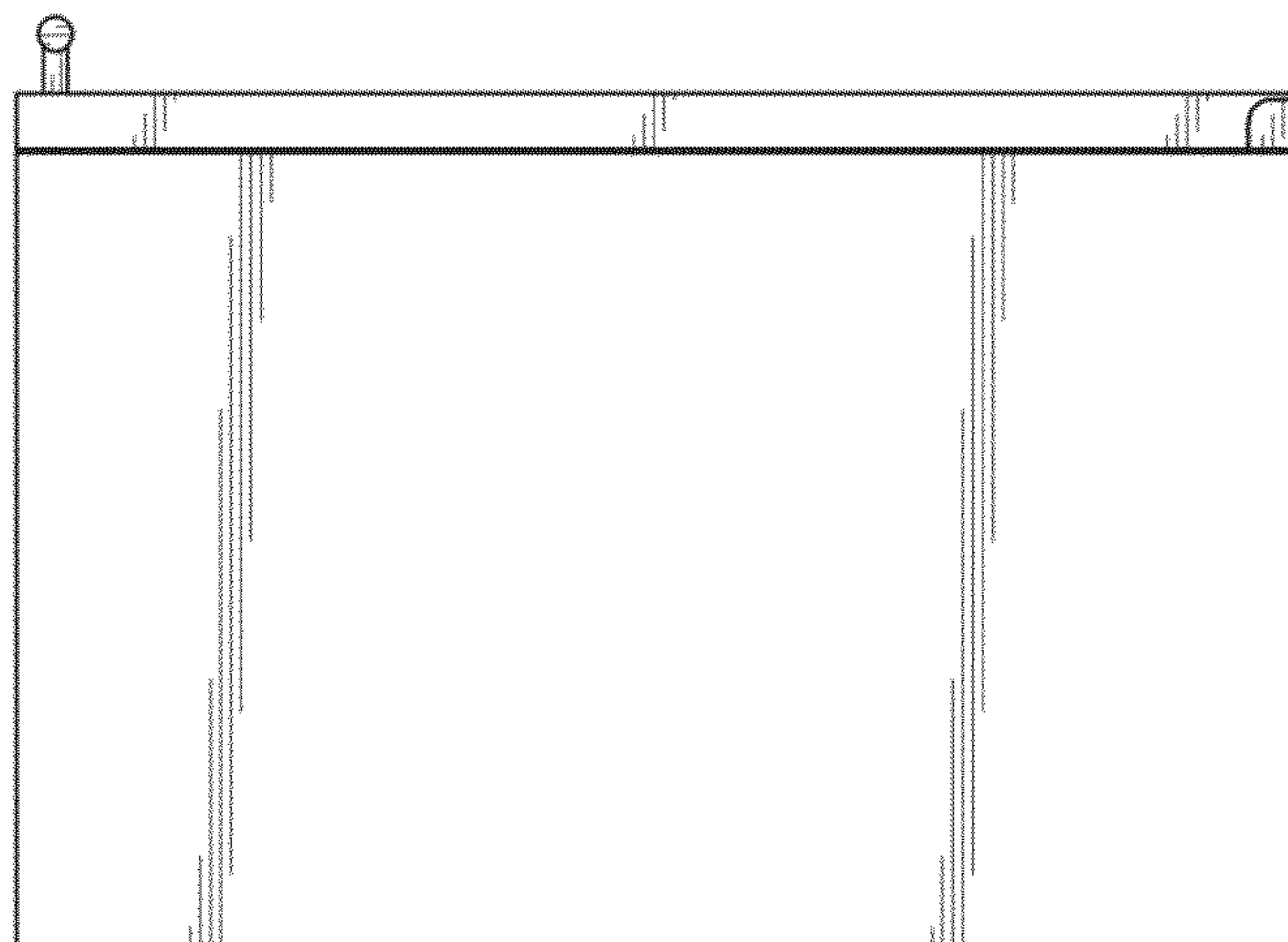

FIG. 7

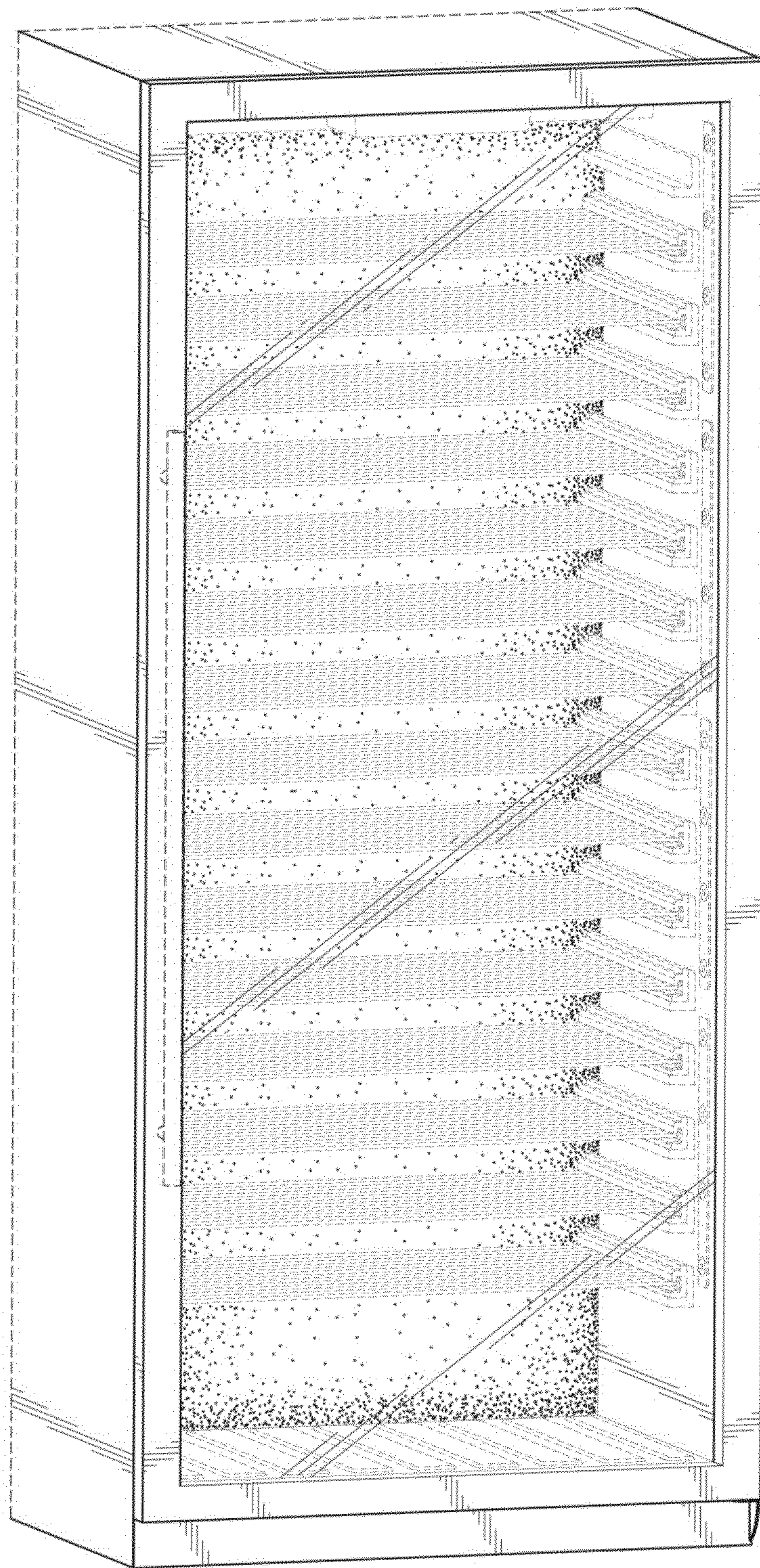

FIG. 8

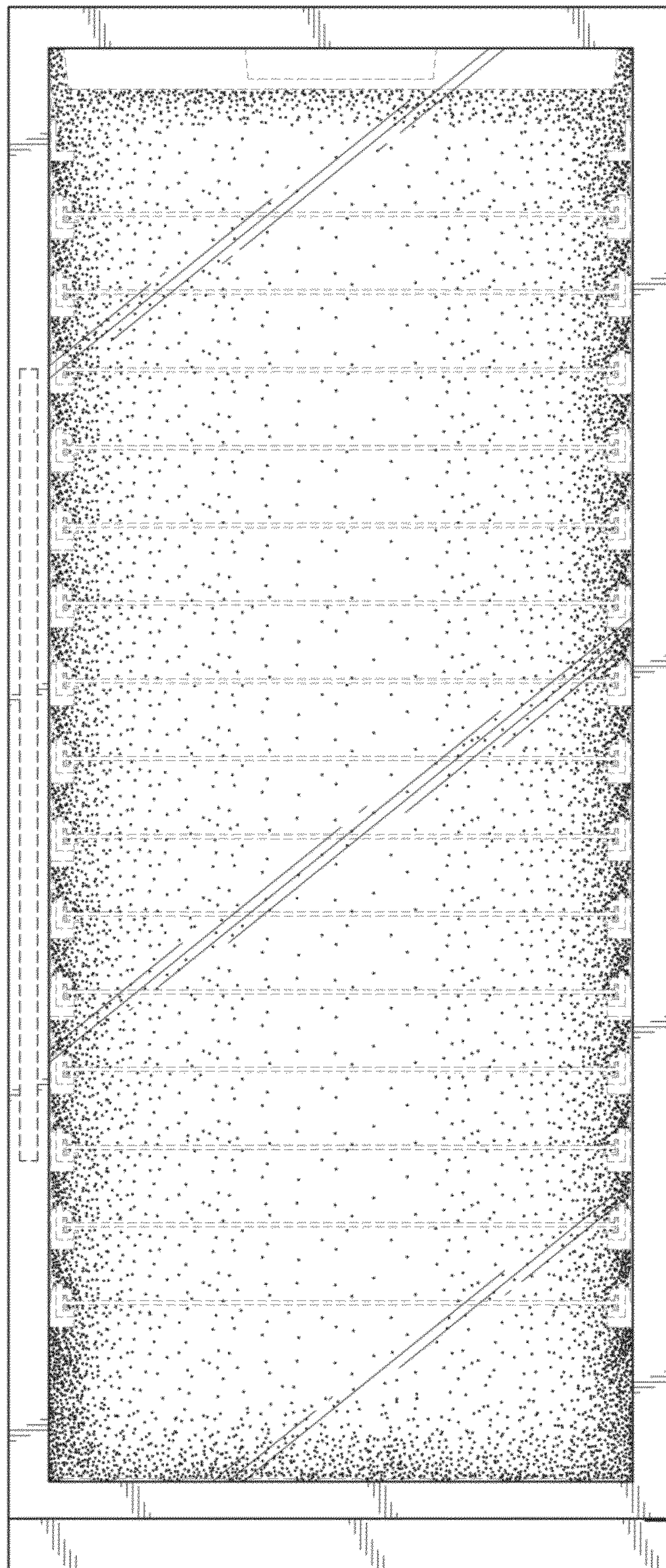

FIG. 9



FIG. 10

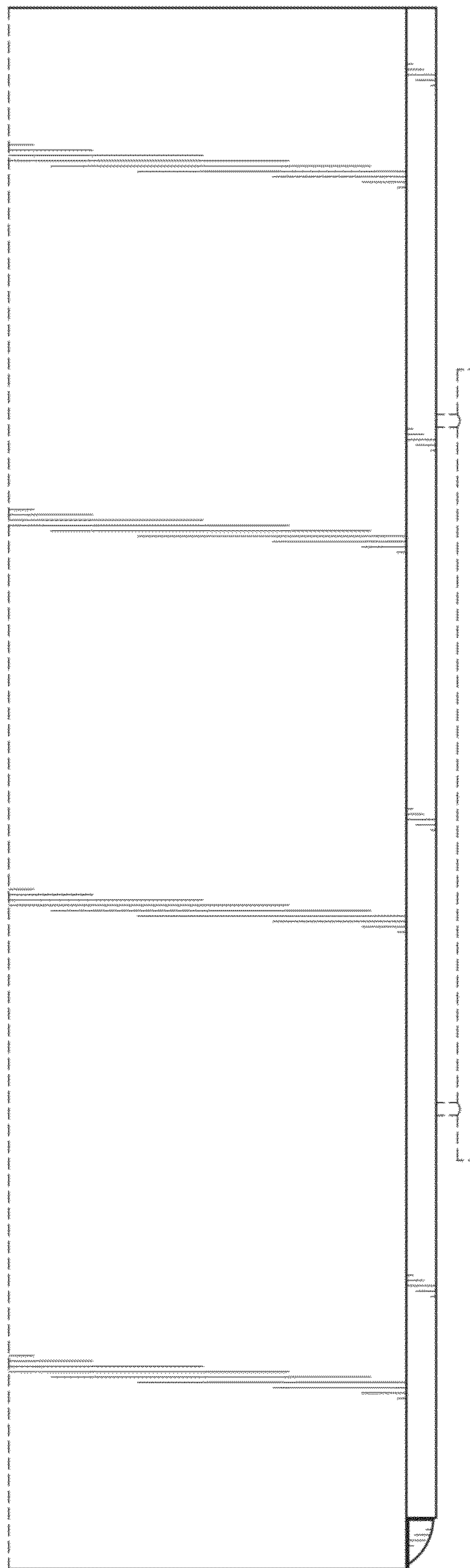

FIG. 11

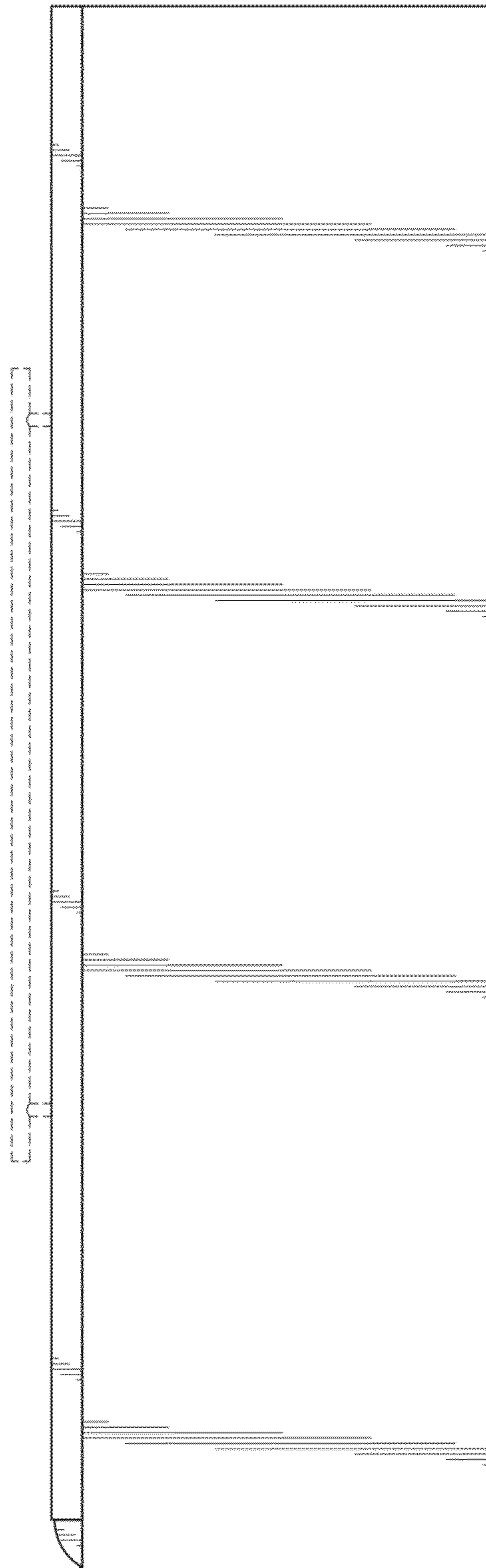

FIG. 12

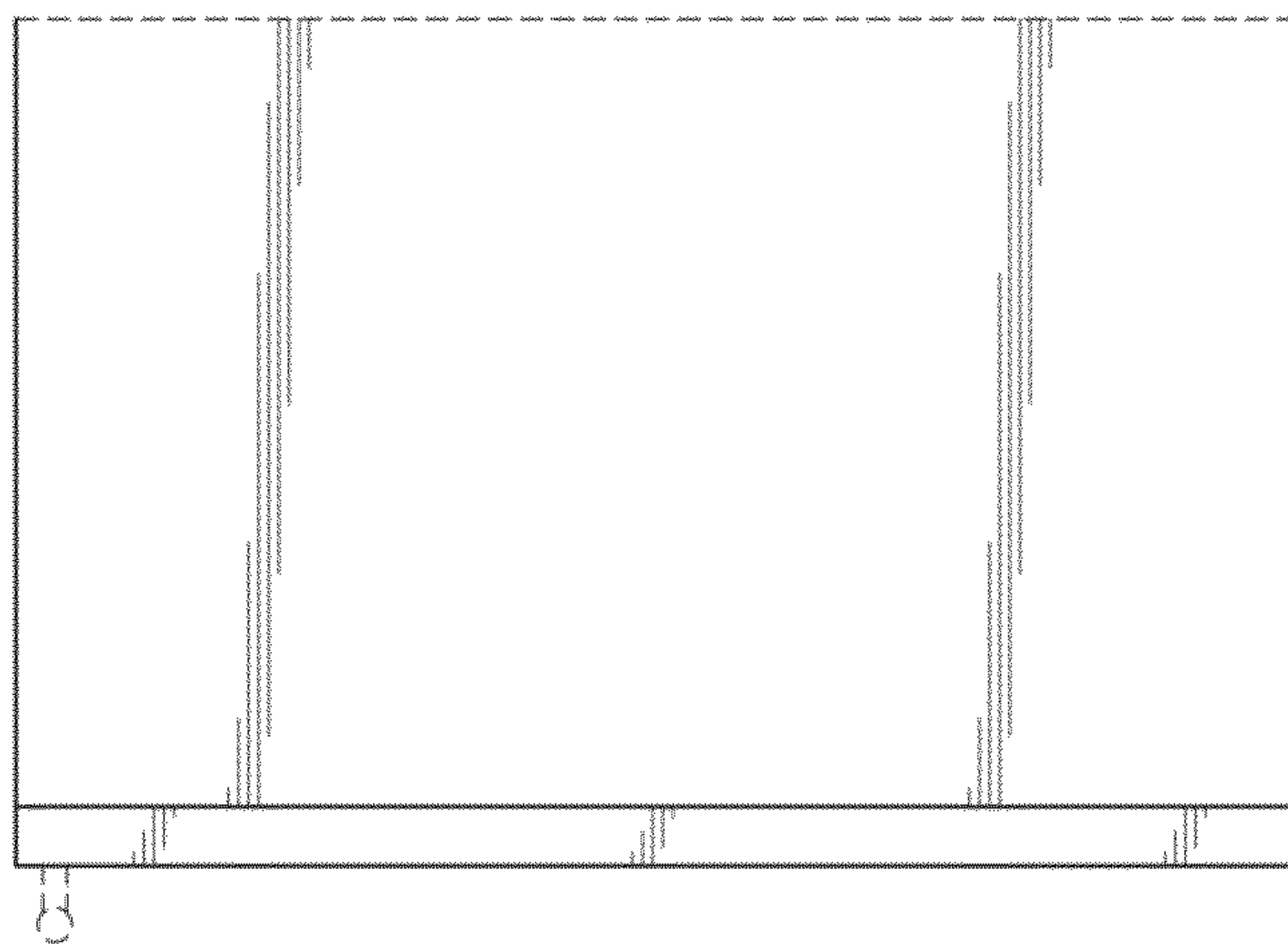

FIG. 13

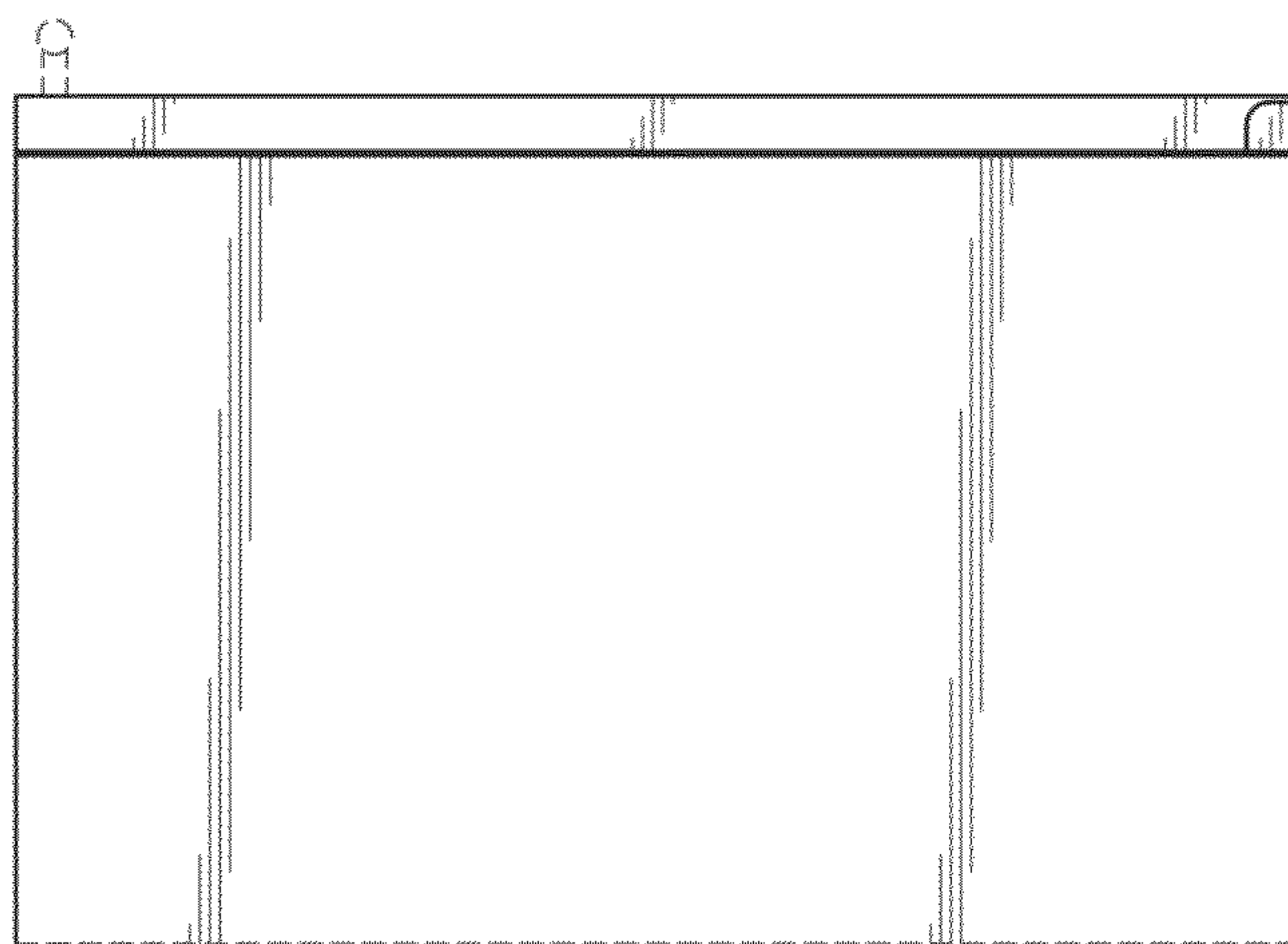

FIG. 14

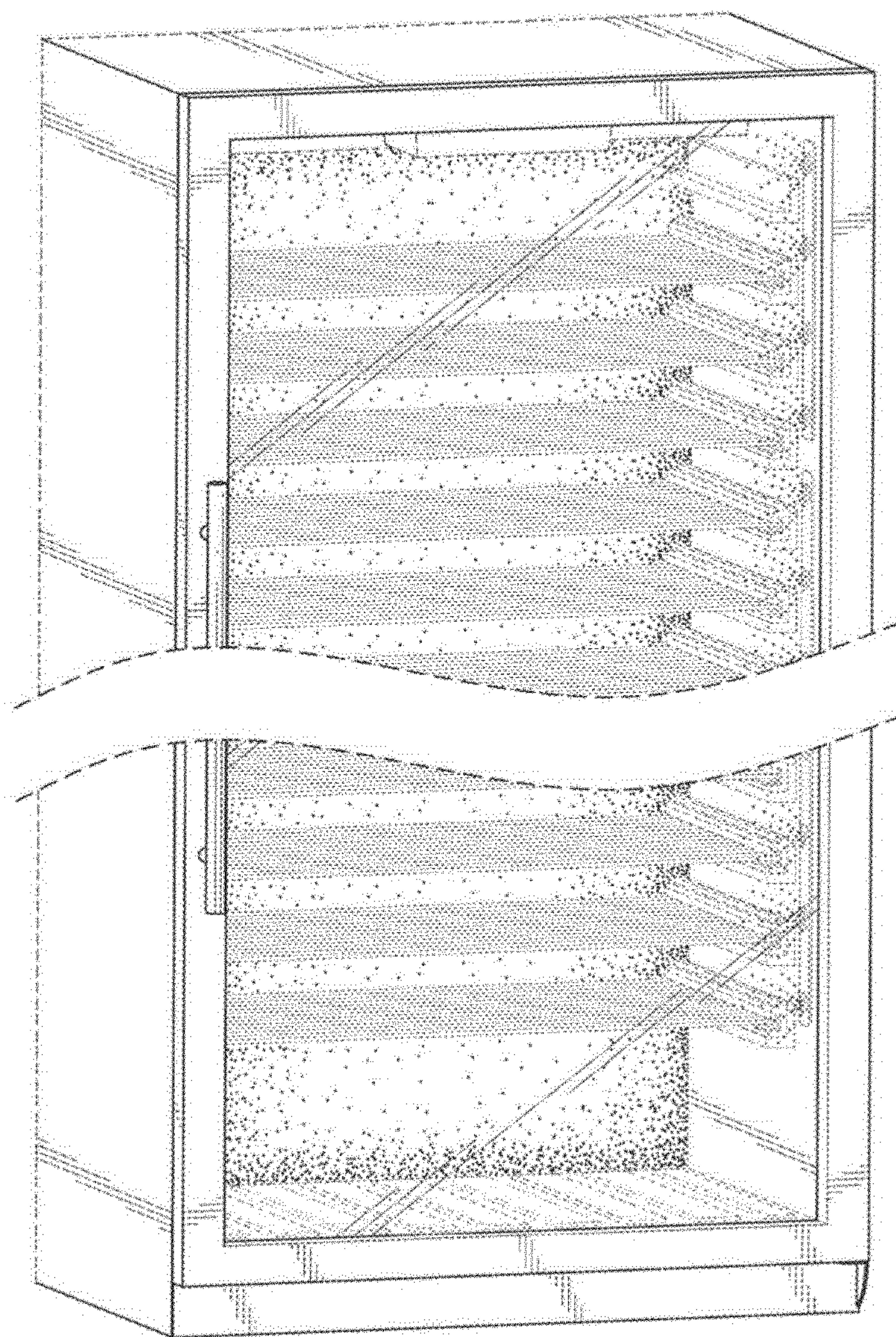

FIG. 15

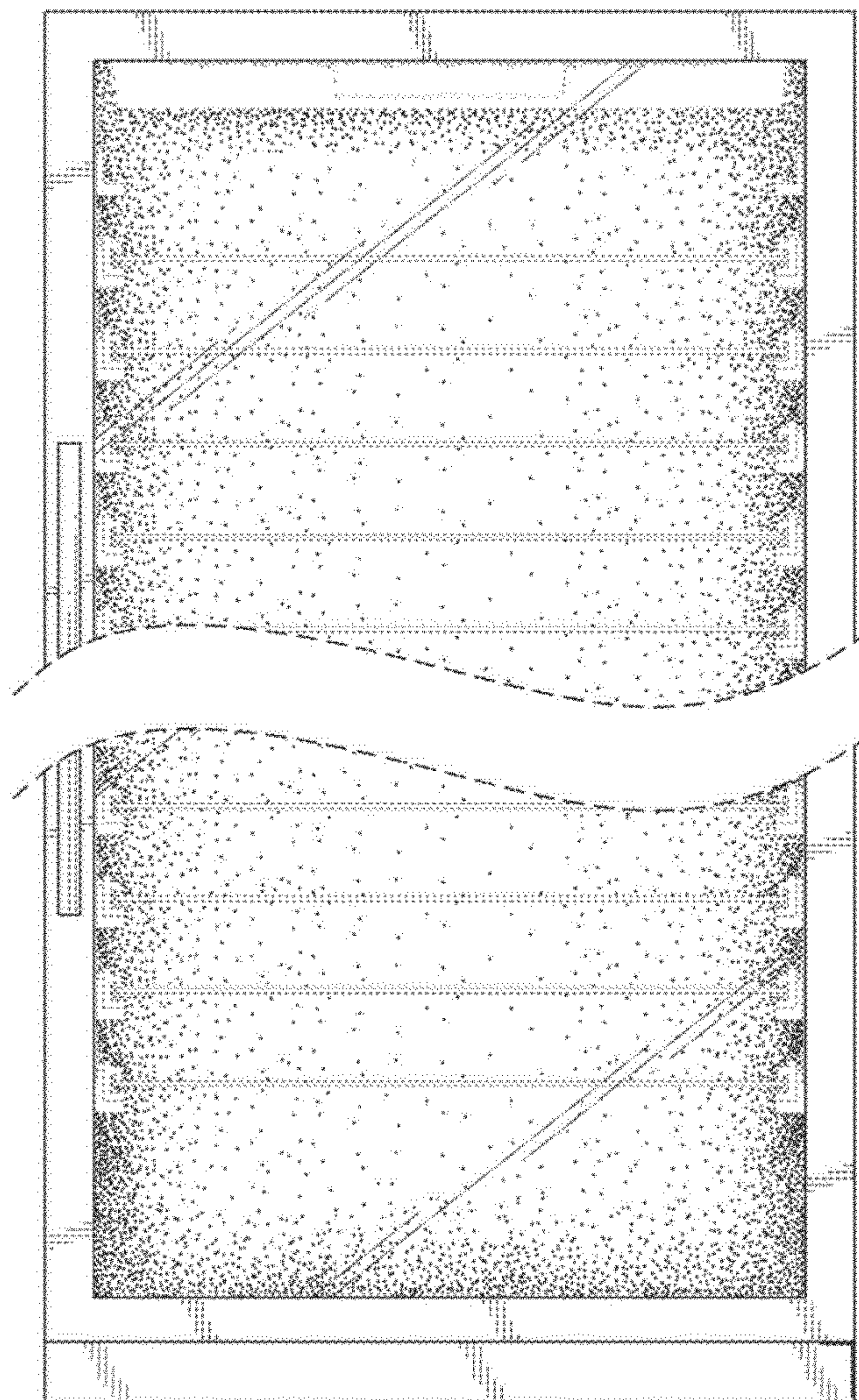

FIG. 16

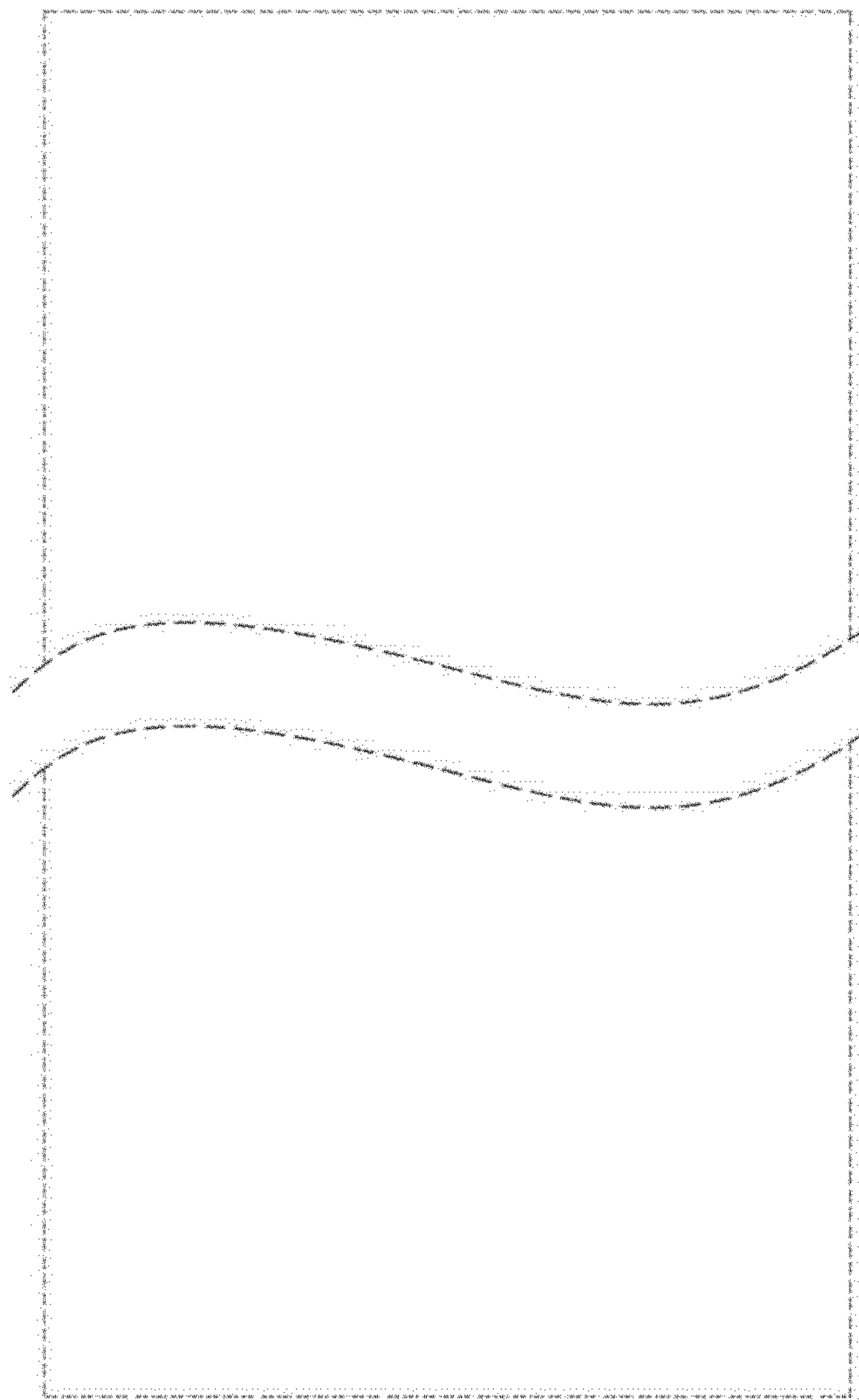

FIG. 17

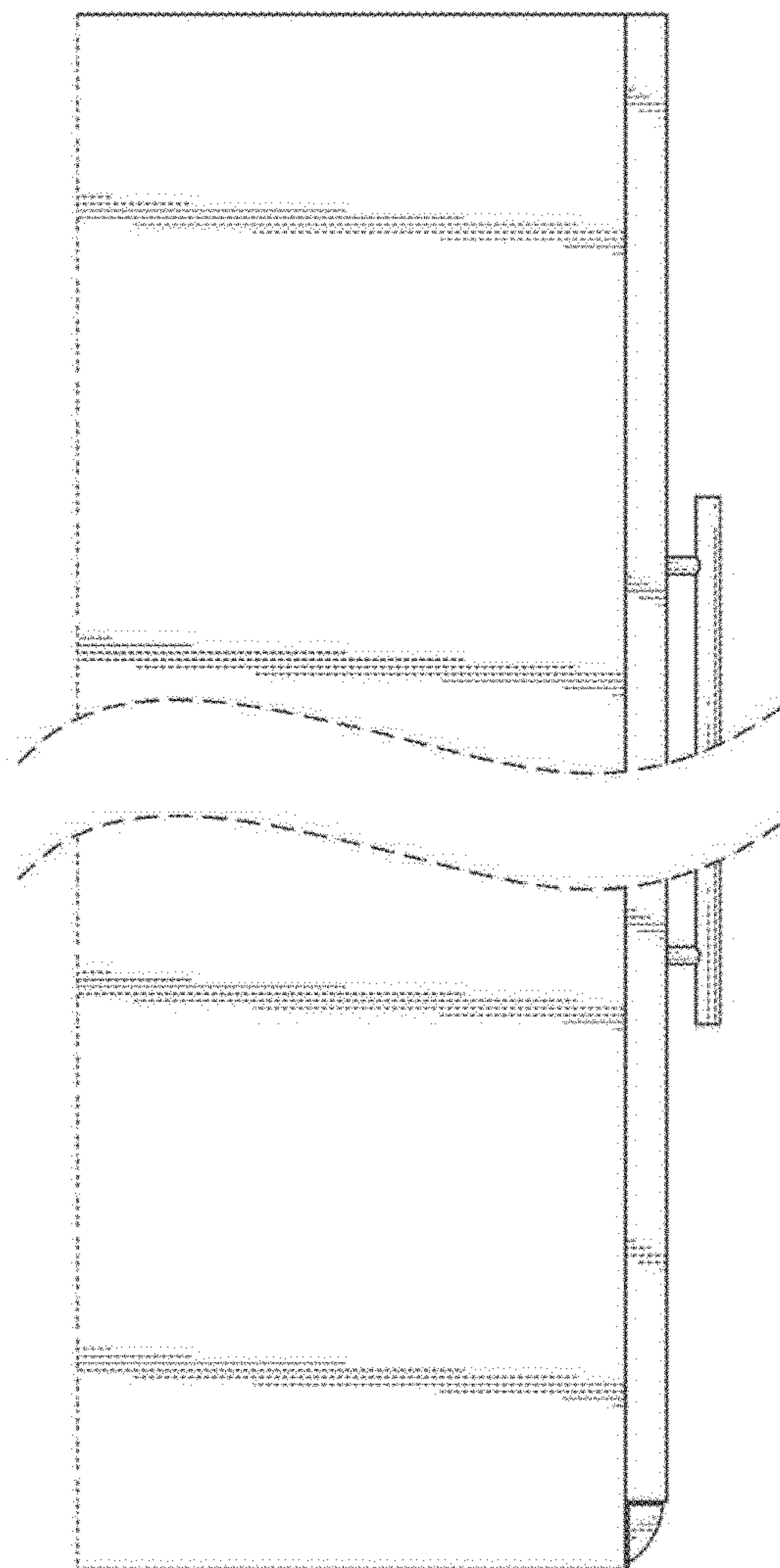

FIG. 18

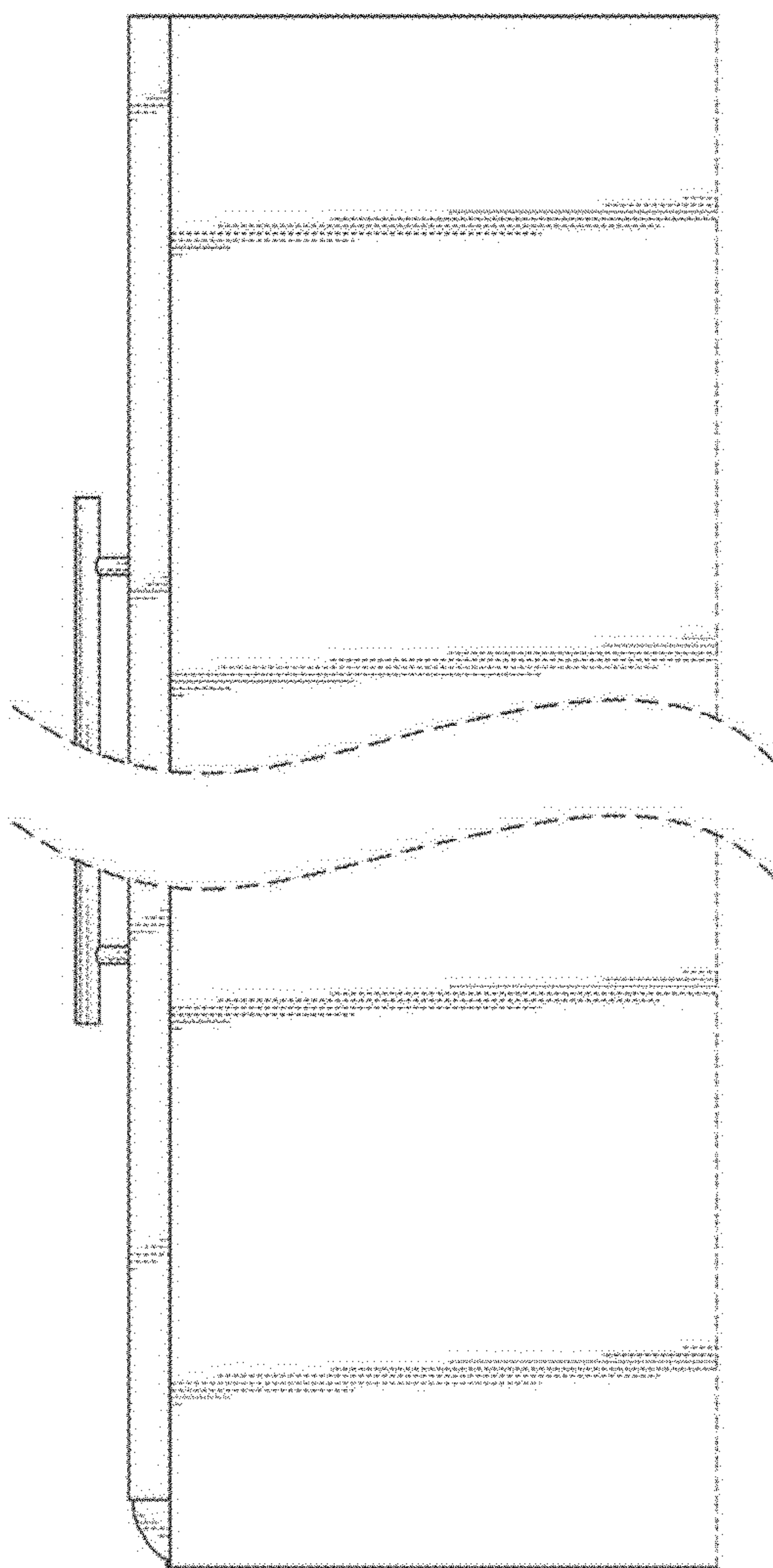

FIG. 19

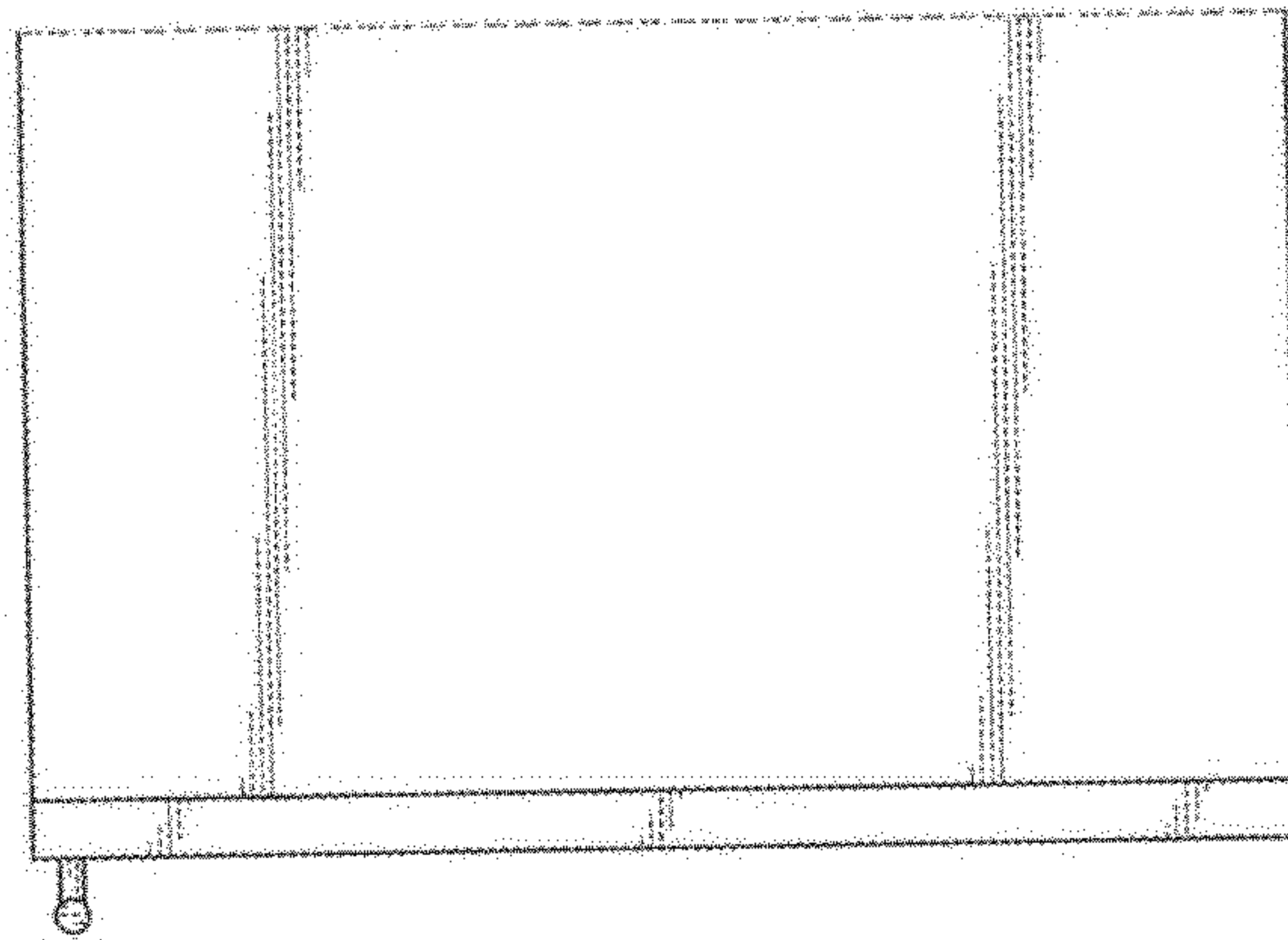

FIG. 20

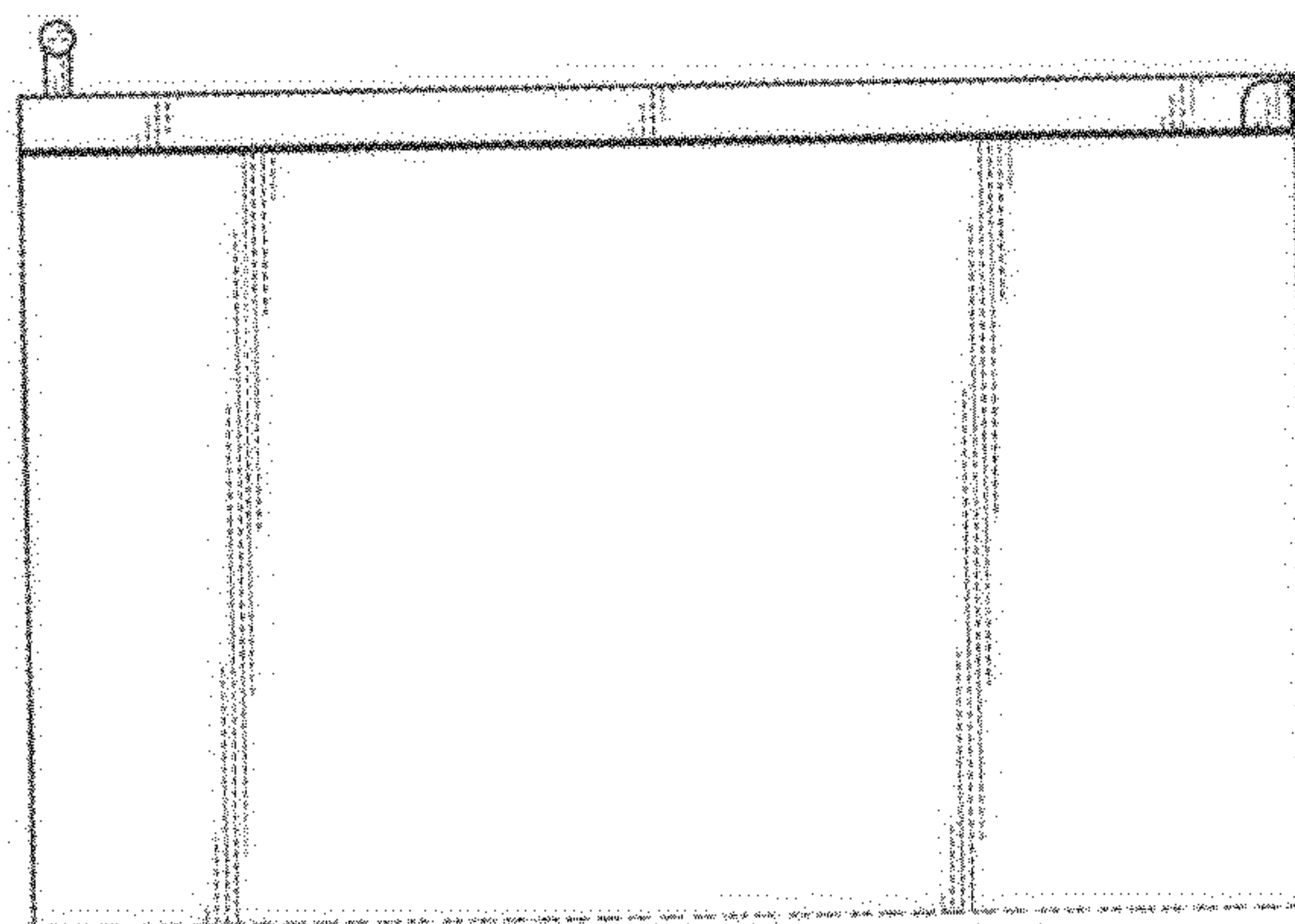

FIG. 21