

US00D868844S

(12) **United States Design Patent** (10) **Patent No.:** **US D868,844 S**
Descoteaux (45) **Date of Patent:** **** Dec. 3, 2019**

- (54) **CARRYING SYSTEM FOR USE WITH THE ROLL BAR OF A VEHICLE**
- (71) Applicant: **Timothy J Descoteaux**, Lakeside, CT (US)
- (72) Inventor: **Timothy J Descoteaux**, Lakeside, CT (US)
- (**) Term: **15 Years**
- (21) Appl. No.: **29/667,696**
- (22) Filed: **Oct. 24, 2018**
- (51) **LOC (12) Cl.** **15-03**
- (52) **U.S. Cl.**
USPC **D15/17; D15/28**
- (58) **Field of Classification Search**
USPC D15/17, 28, 22, 23, 26, 10; D12/412, D12/413, 414, 414.1, 159, 222; 224/400, 224/410; D29/100; D3/315
CPC B60R 9/00; B60R 9/02; B60R 9/04; B60R 9/08; B60R 9/055; B60R 9/058; B60R 9/06; B60R 9/065; B60R 9/10; B60R 9/12; B60R 2011/004; B60R 2011/0052; B60R 2011/0085; B60R 21/131; B62D 33/023; B62D 49/08
See application file for complete search history.

(56) **References Cited**

U.S. PATENT DOCUMENTS

D396,347 S * 7/1998 Jenkins D3/327
5,961,014 A * 10/1999 Knerr A45F 3/04
224/153
6,257,470 B1 * 7/2001 Schaefer B60R 9/055
224/318
D449,136 S * 10/2001 Vallance D29/100
D455,009 S * 4/2002 Thayer D3/316
D457,688 S * 5/2002 Cordero D2/627

6,382,293 B1 * 5/2002 Brockington E04F 10/0625
160/46
D500,393 S * 12/2004 Beacham D29/100
D650,586 S * 12/2011 Hutcheson D3/316
D743,628 S * 11/2015 Millington D29/101.1
D777,990 S * 1/2017 Mathews, Jr. D29/100
D781,002 S * 3/2017 Mathews, Jr. D29/100
D840,153 S * 2/2019 Persellin D3/315
10,378,234 B1 * 8/2019 Nielsen E04H 15/06
2001/0002087 A1 * 5/2001 Townsend A42B 3/0473
280/801.1
2009/0039128 A1 * 2/2009 Damico B60R 7/043
224/572

(Continued)

Primary Examiner — Mark A Goodwin

(74) Attorney, Agent, or Firm — Carla Gannon Law

(57) **CLAIM**

I claim the ornamental design for a carrying system for use with the roll bar of a vehicle, as shown and described.

DESCRIPTION

FIG. 1 is a front/side perspective view of the carrying system for use with the roll bar of a vehicle showing my new design; FIG. 2 is the front view of the carrying system of FIG. 1; FIG. 3 is the back view of the carrying system of FIG. 1; FIG. 4 is the top view of the carrying system of FIG. 1; FIG. 5 is the bottom view of the carrying system of FIG. 1; FIG. 6 is a side view of the carrying system of FIG. 1; FIG. 7 is the opposite side view of the carrying system of FIG. 6; and, FIG. 8 is a front/side perspective view of the carrying system of FIG. 1 connected to a vehicle.

The broken lines showing the roll bar in FIGS. 1-8 are included for purposes of illustrating the carrying system in use, and form no part of the claimed invention.

The broken lines showing the vehicle and rake of FIG. 8 are included for purposes of illustrating the carrying system in use, and form no part of the claimed invention.

1 Claim, 6 Drawing Sheets

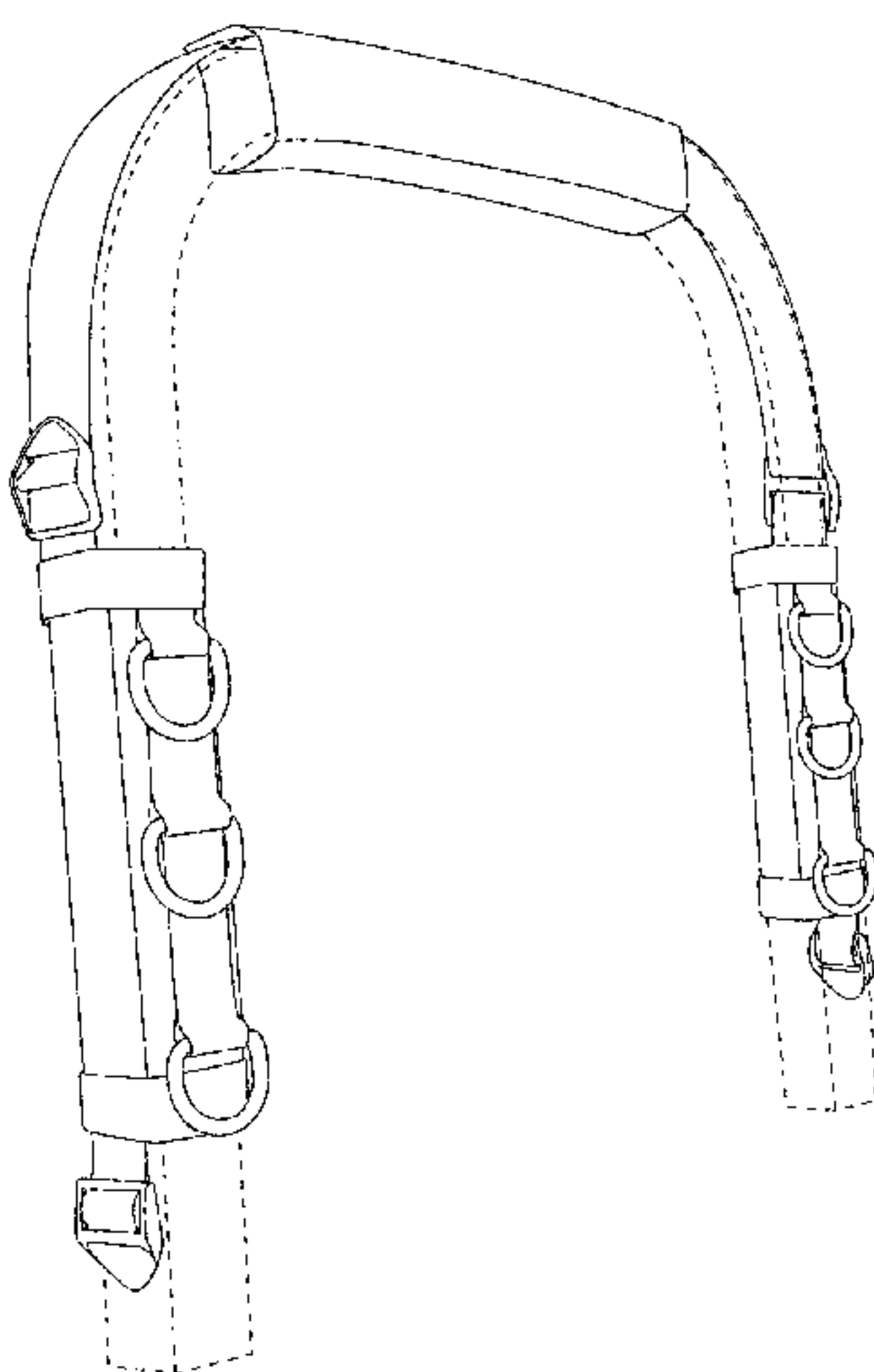

(56)

References Cited

U.S. PATENT DOCUMENTS

2013/0186923 A1* 7/2013 Gier B60R 9/06
224/403
2015/0150342 A1* 6/2015 Danze B60P 7/0823
24/68 E
2017/0203699 A1* 7/2017 Williams B60R 9/10

* cited by examiner

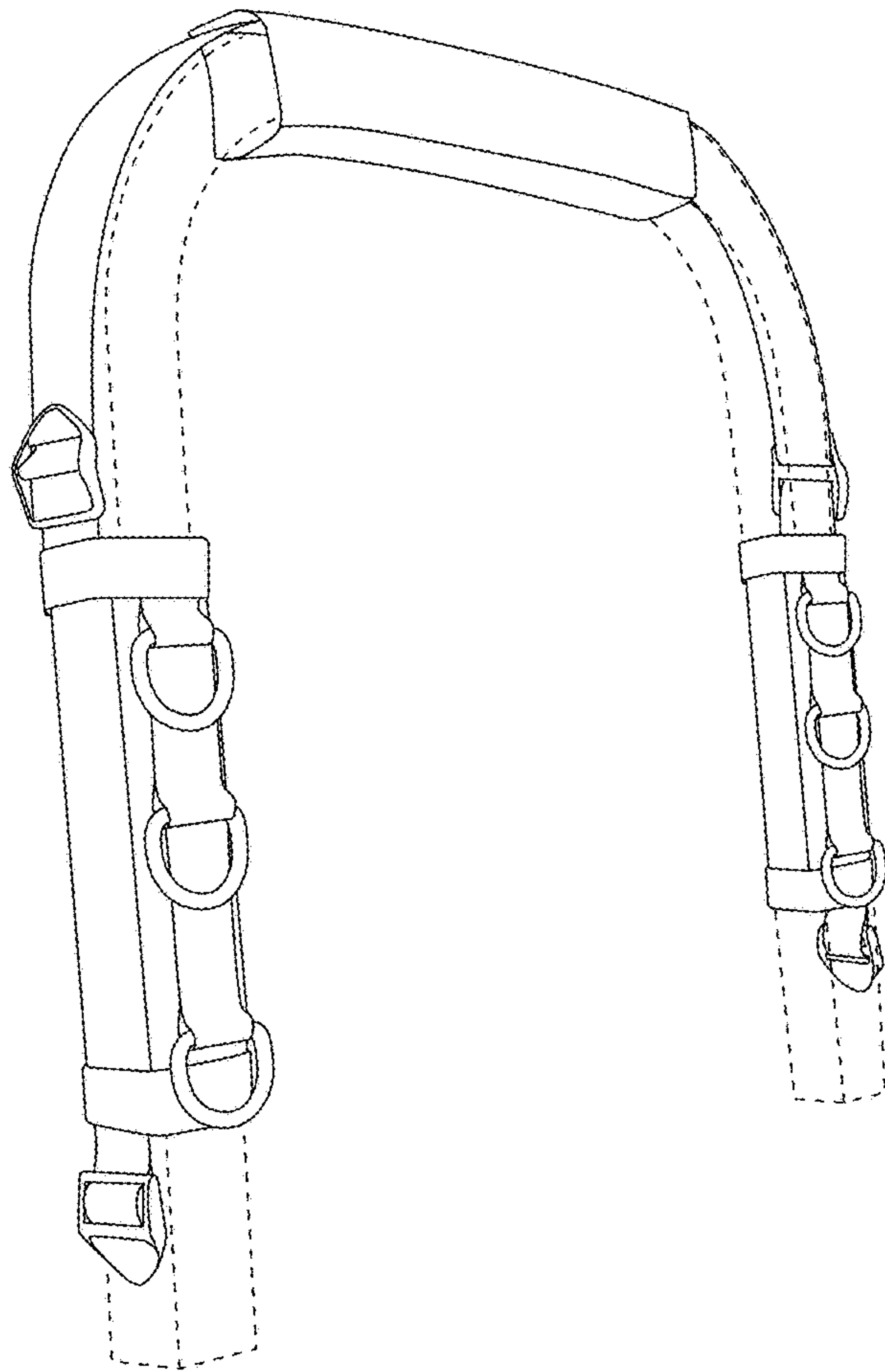

FIG. 1

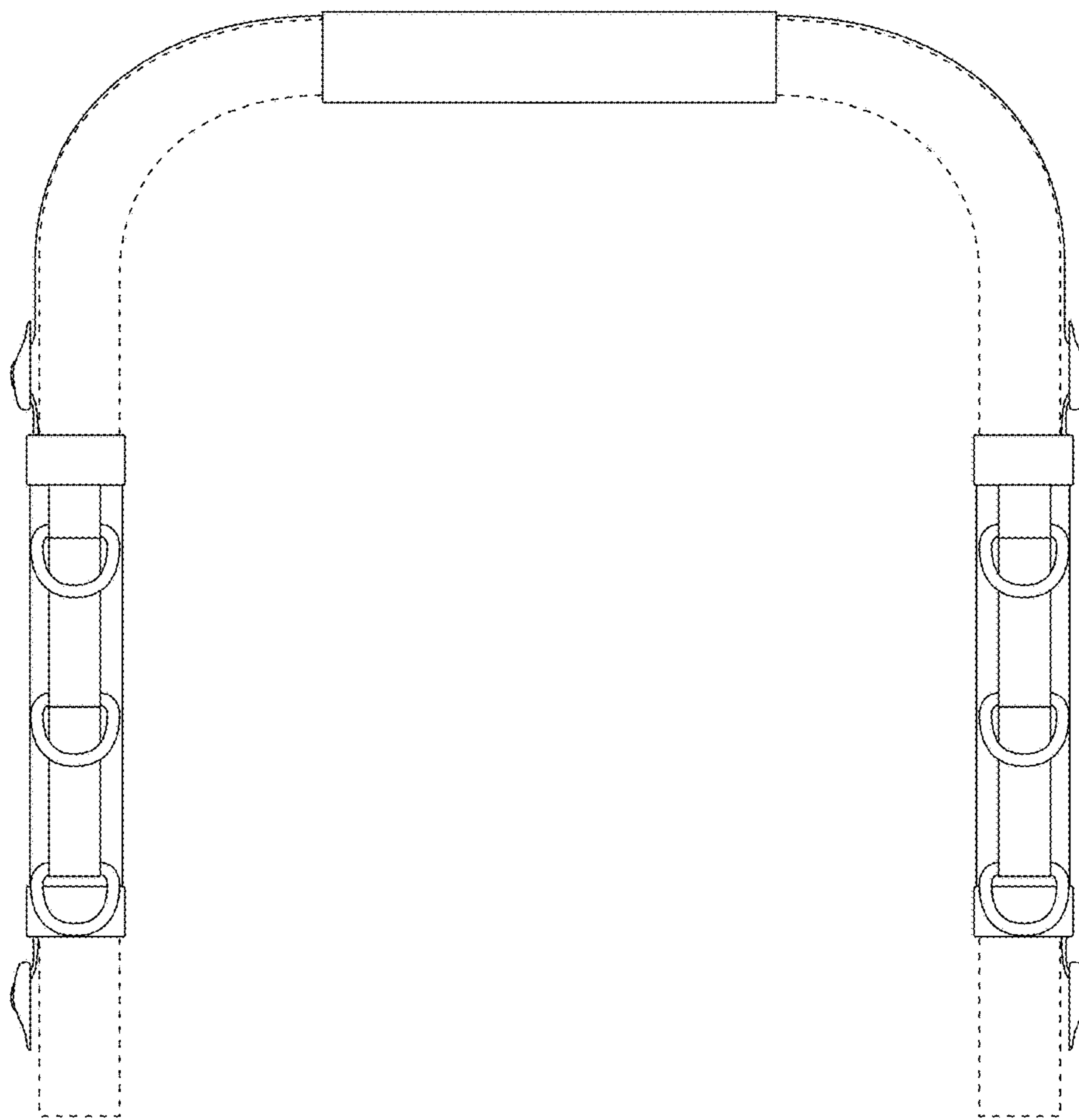

FIG. 2

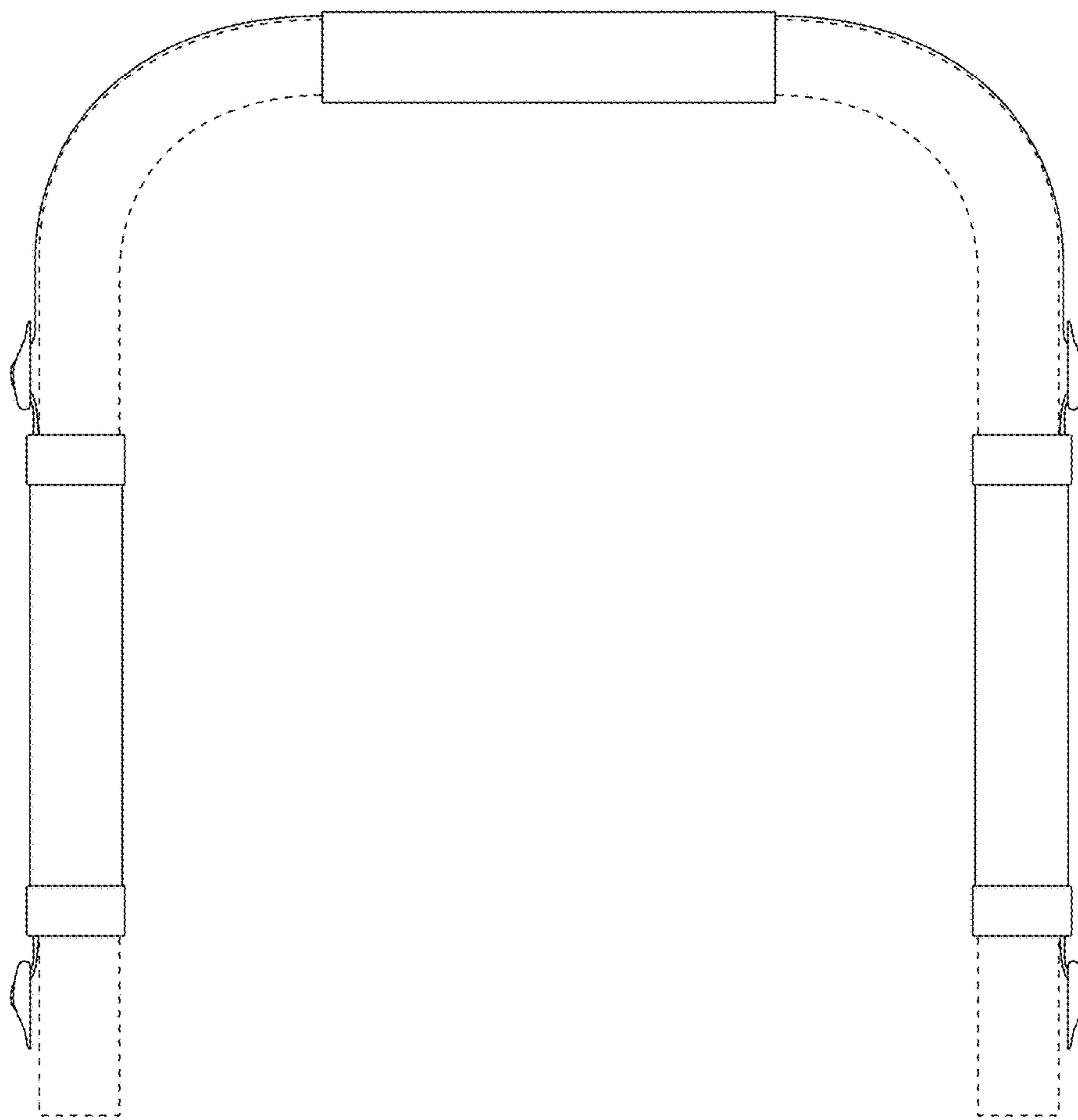

FIG. 3

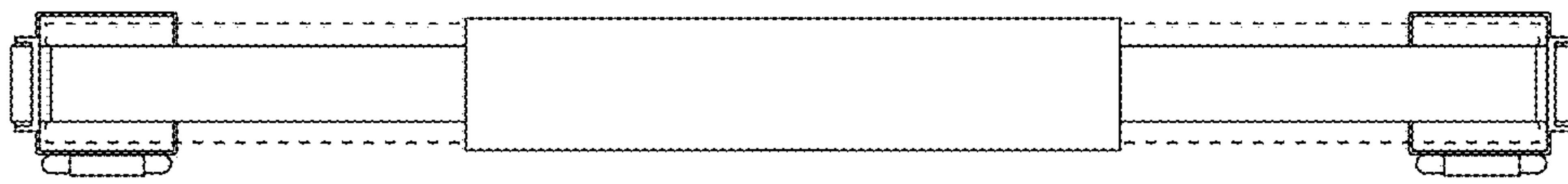

FIG. 4

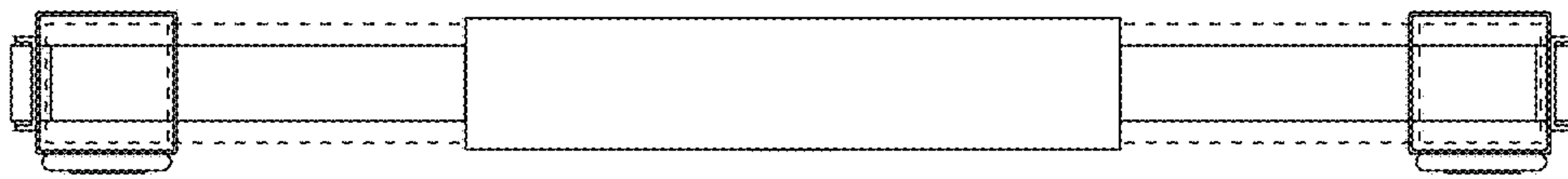

FIG. 5

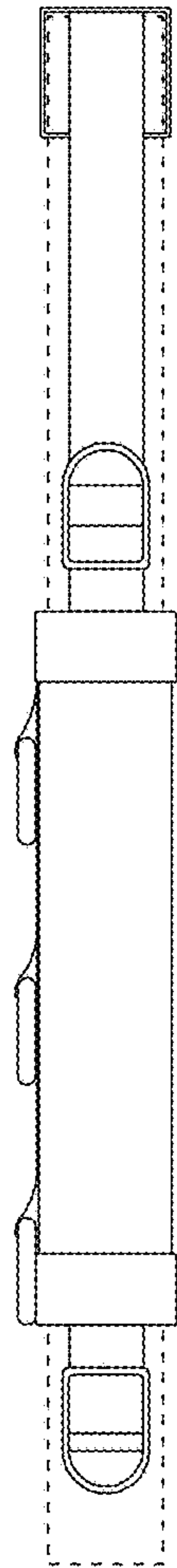

FIG. 6

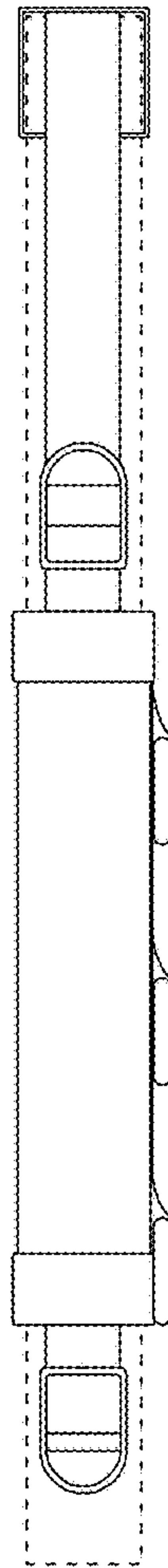

FIG. 7

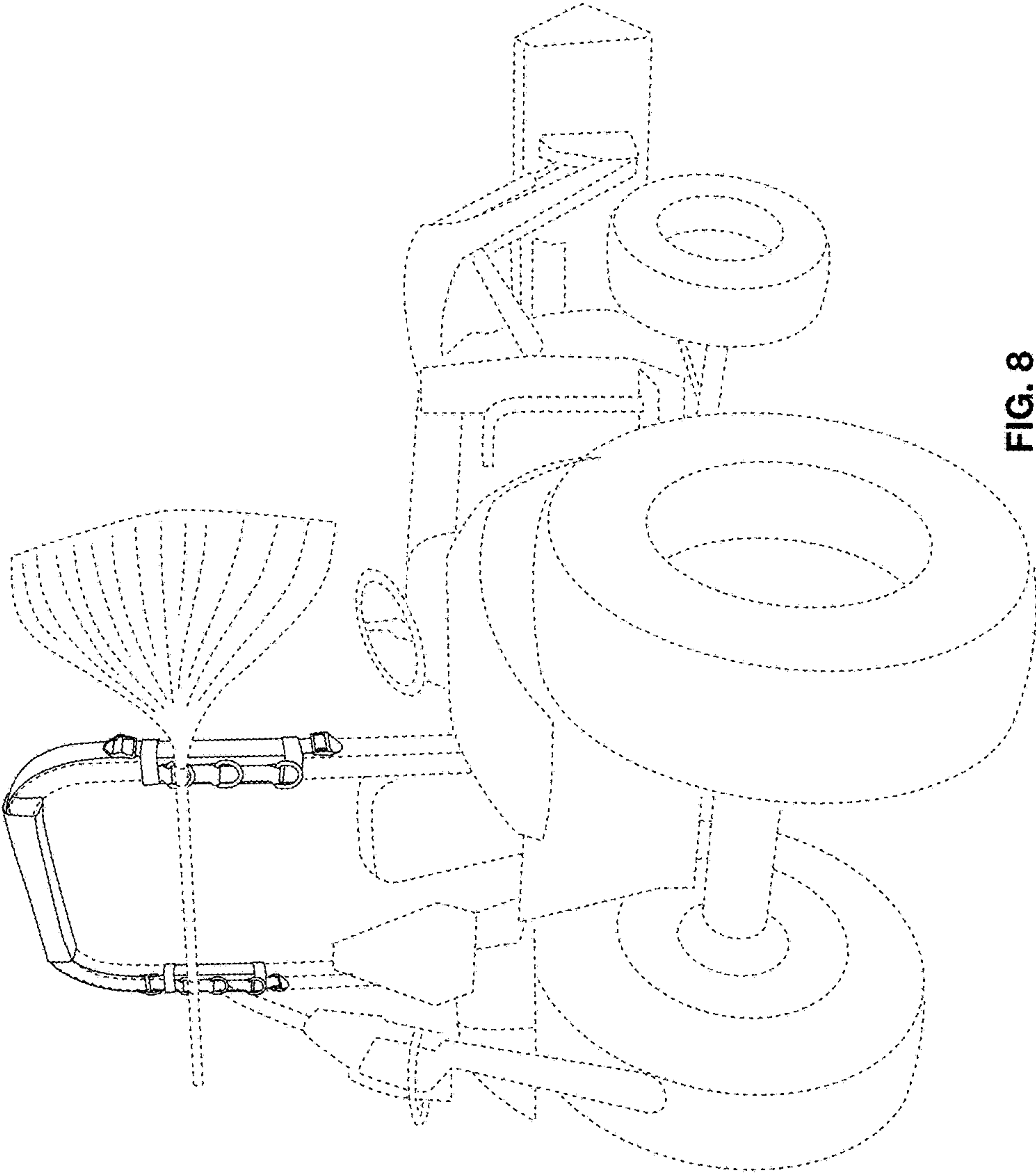

FIG. 8