

US00D868785S

(12) **United States Design Patent**
Liu

(10) **Patent No.:** **US D868,785 S**

(45) **Date of Patent:** **** Dec. 3, 2019**

(54) **GAMING MOUSE**

(71) Applicant: **Ming Liu, Jiangxi (CN)**

(72) Inventor: **Ming Liu, Jiangxi (CN)**

(**) Term: **15 Years**

(21) Appl. No.: **29/605,106**

(22) Filed: **May 24, 2017**

(51) **LOC (12) Cl.** **14-02**

(52) **U.S. Cl.**
USPC **D14/409**

(58) **Field of Classification Search**
USPC D14/402-411, 356, 388, 389, 383-385,
D14/417, 426; 345/156-167; 463/36-38;
358/471, 473; 273/148 B
CPC G06F 3/03543; G06F 2203/0333; G06F
3/039; G06F 3/038; G06F 2203/0384
See application file for complete search history.

(56) **References Cited**

U.S. PATENT DOCUMENTS

D680,113 S * 4/2013 Li D14/409
D688,245 S * 8/2013 Guerra D14/409

D712,903 S * 9/2014 Lai D14/409
D718,310 S * 11/2014 Moon D14/409
D729,804 S * 5/2015 Jost D14/410
D744,485 S * 12/2015 Young D14/409
D764,470 S * 8/2016 Jost D14/406
D766,903 S * 9/2016 Young D14/402
D768,633 S * 10/2016 Helwig D14/402
D771,046 S * 11/2016 Jost D14/410
D794,638 S * 8/2017 Zheng D14/409

* cited by examiner

Primary Examiner — Austin Murphy

(57) **CLAIM**

The ornamental design for gaming mouse, as shown and described.

DESCRIPTION

FIG. 1 is a front elevational view of gaming mouse showing my new design;
FIG. 2 is a rear elevational view thereof;
FIG. 3 is a left side elevational view thereof;
FIG. 4 is a right side elevational view thereof;
FIG. 5 is a top plan view thereof; and,
FIG. 6 is a bottom plan view thereof.
The broken lines shown in drawings are for the purpose of illustrating portions of the gaming mouse and form no part of the claimed design.

1 Claim, 6 Drawing Sheets

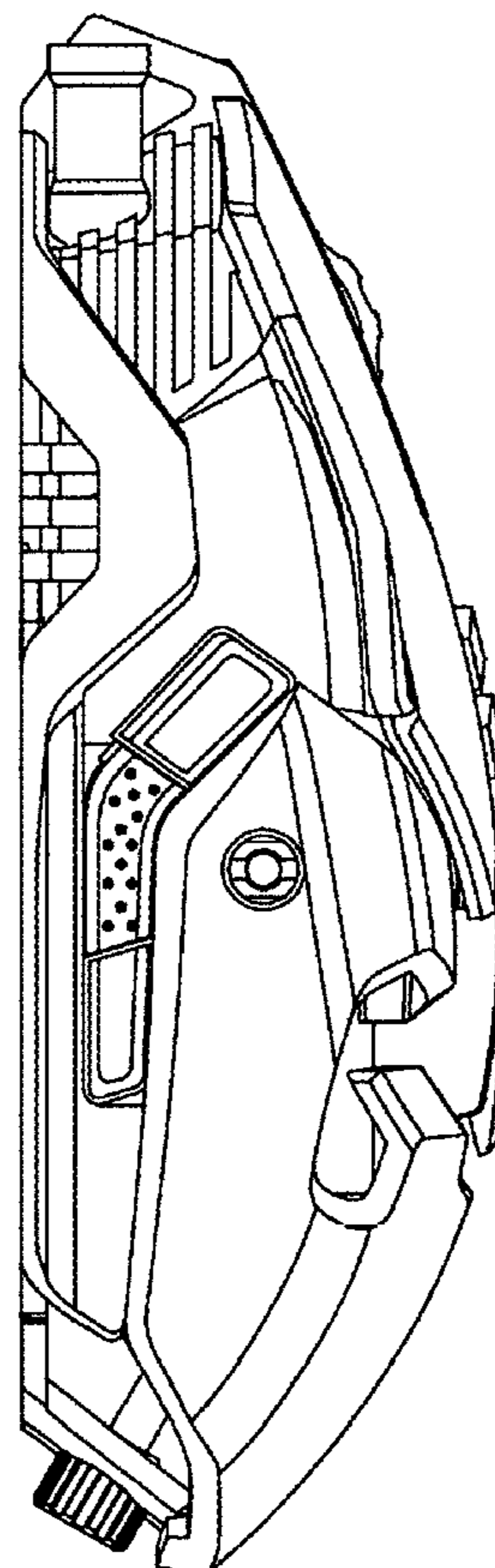
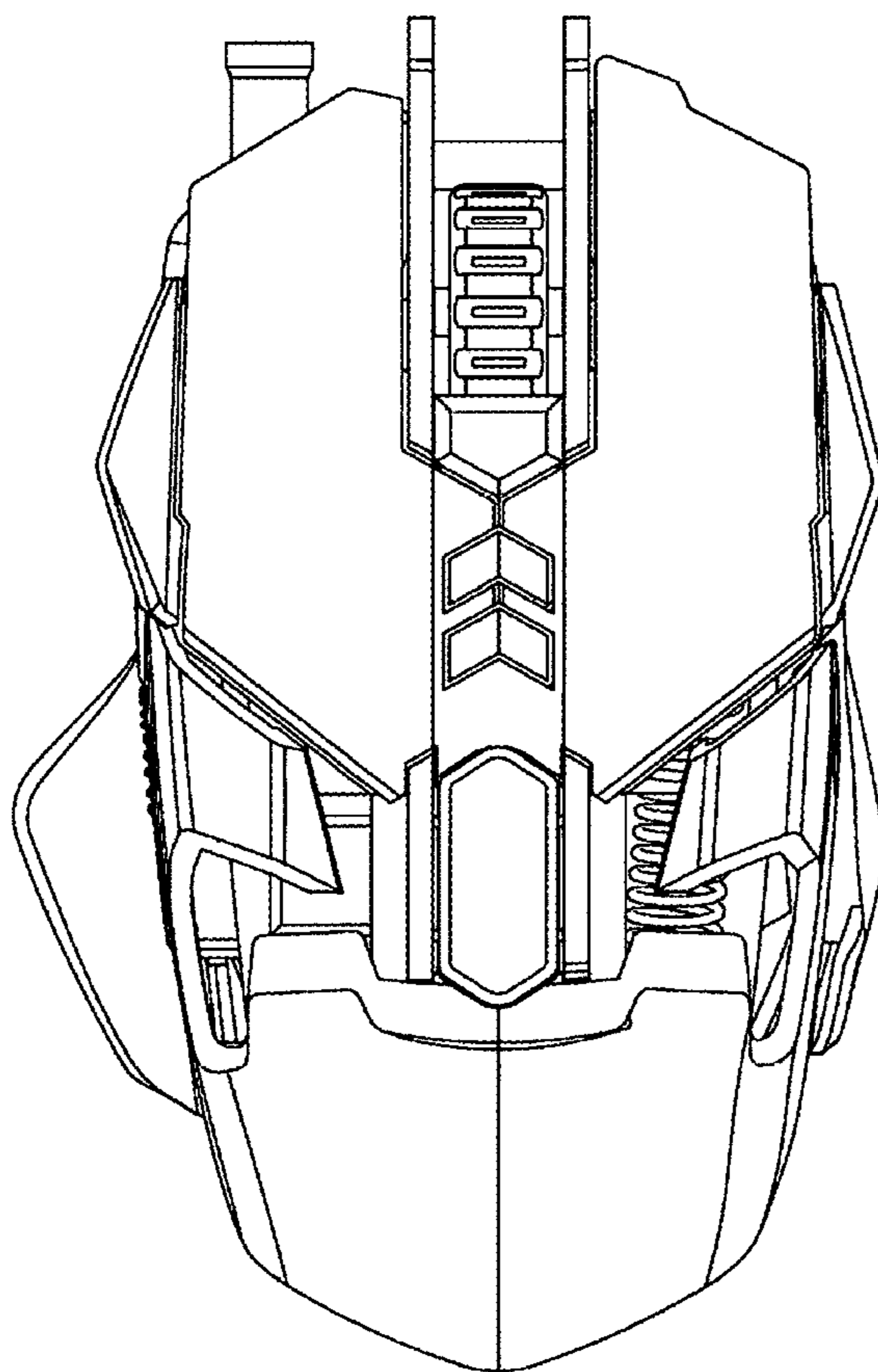

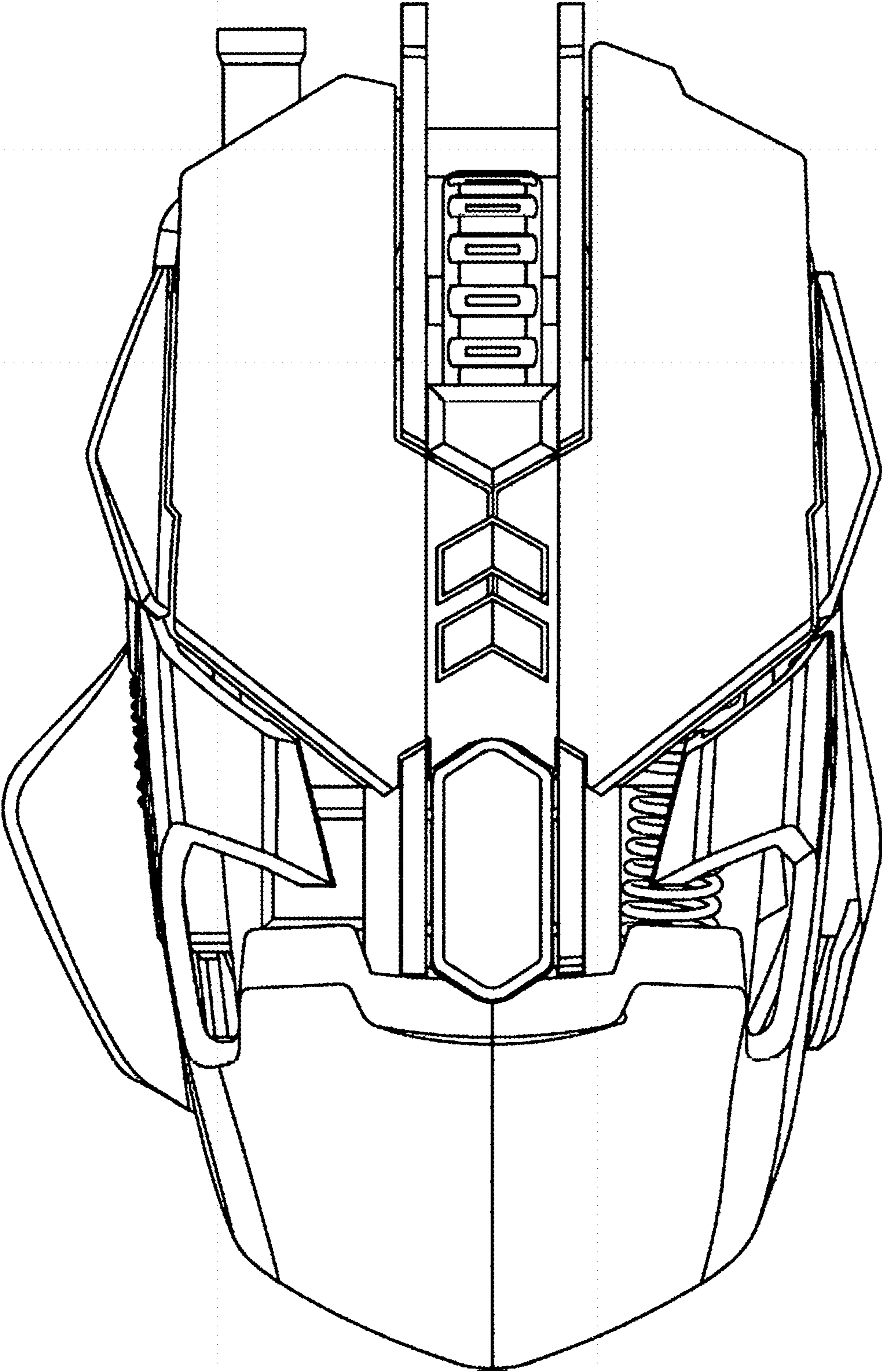

FIG.1

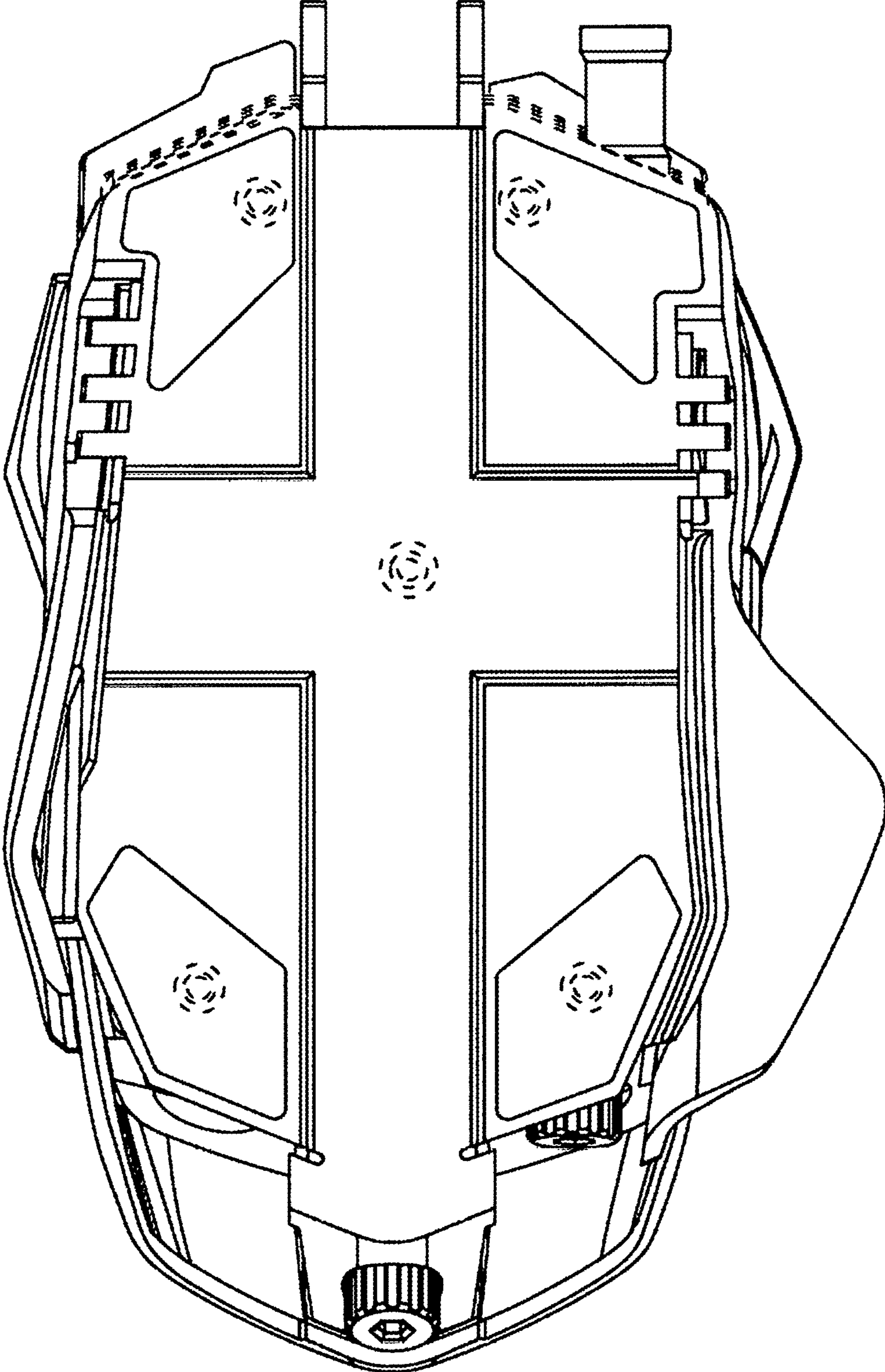

FIG.2

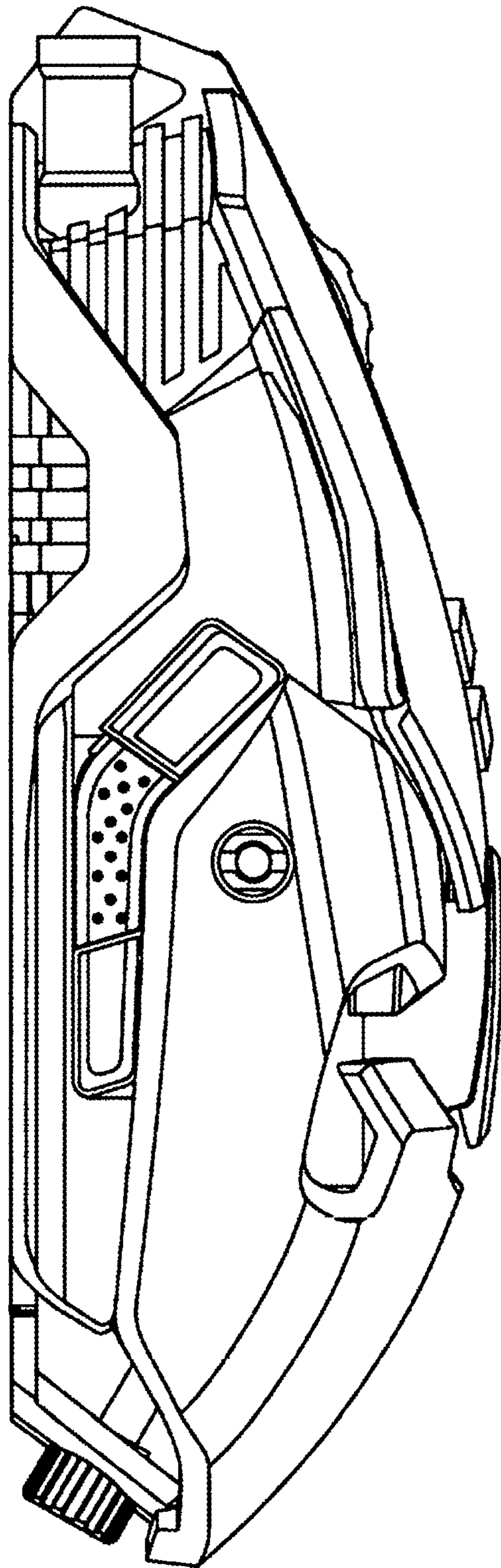

FIG.3

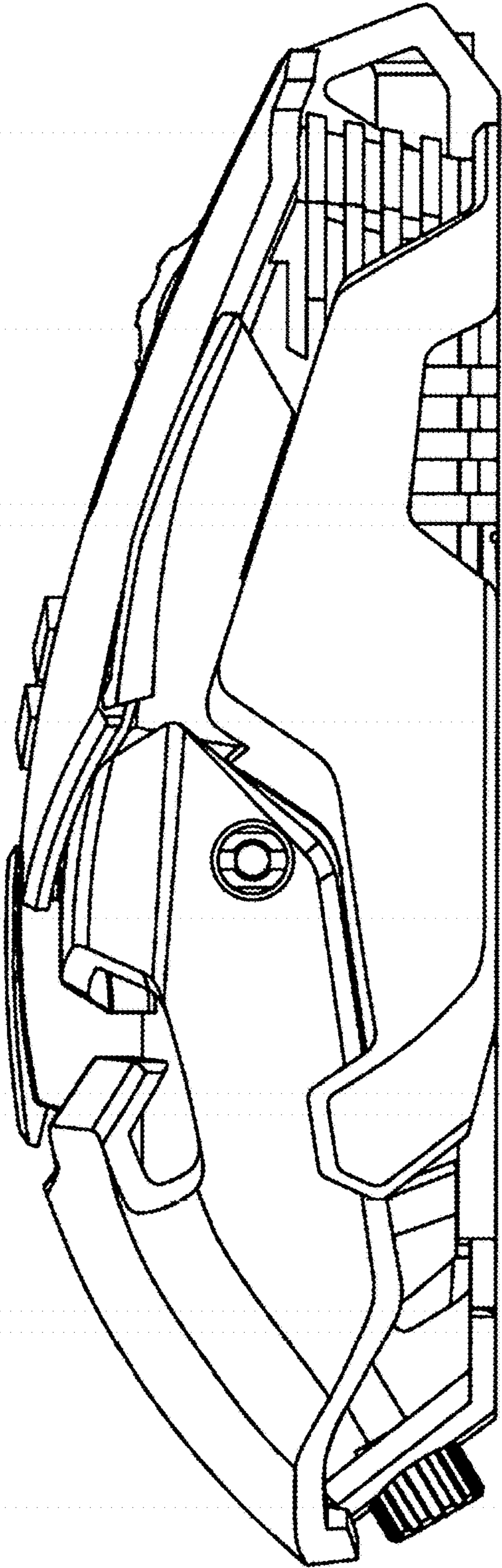

FIG.4

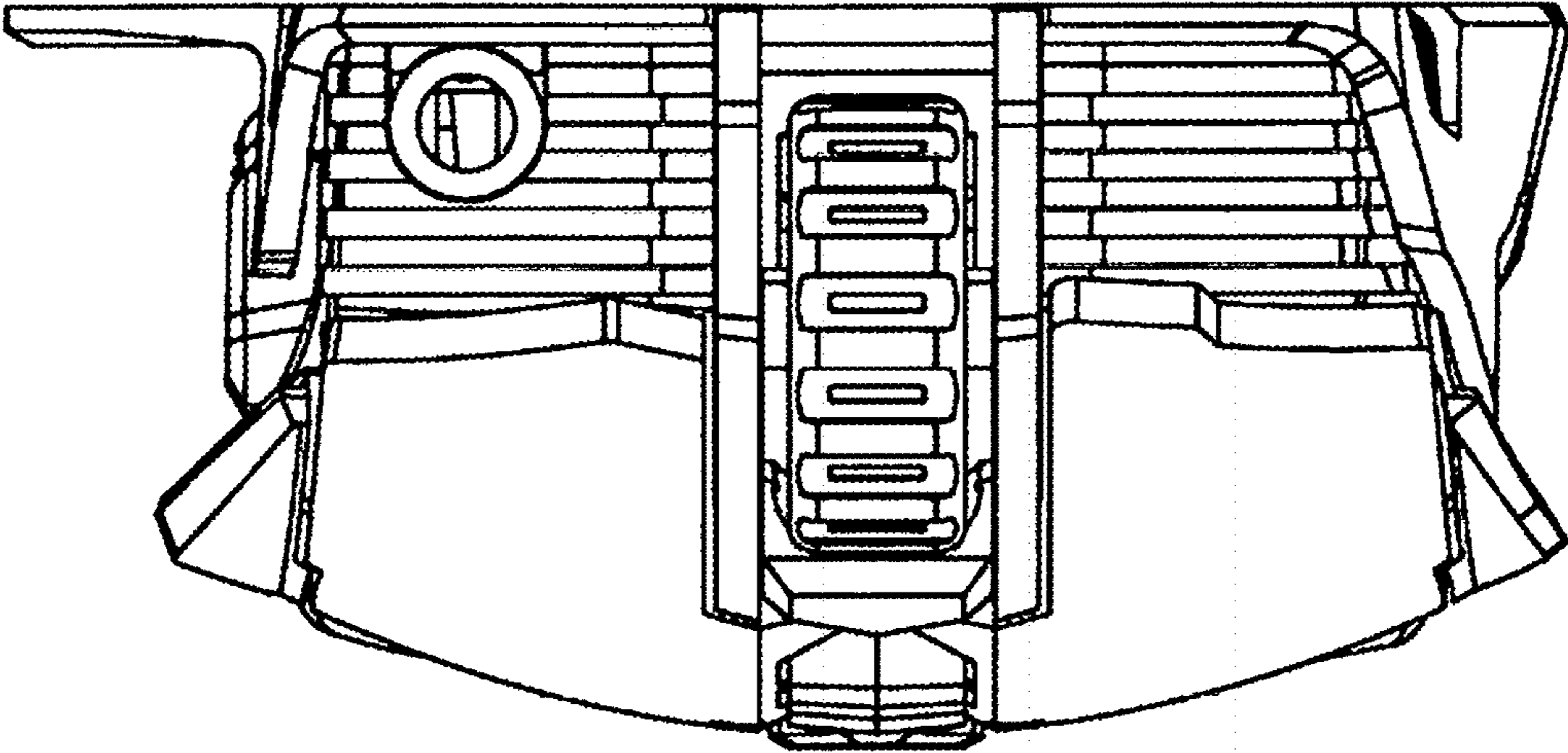

FIG. 5

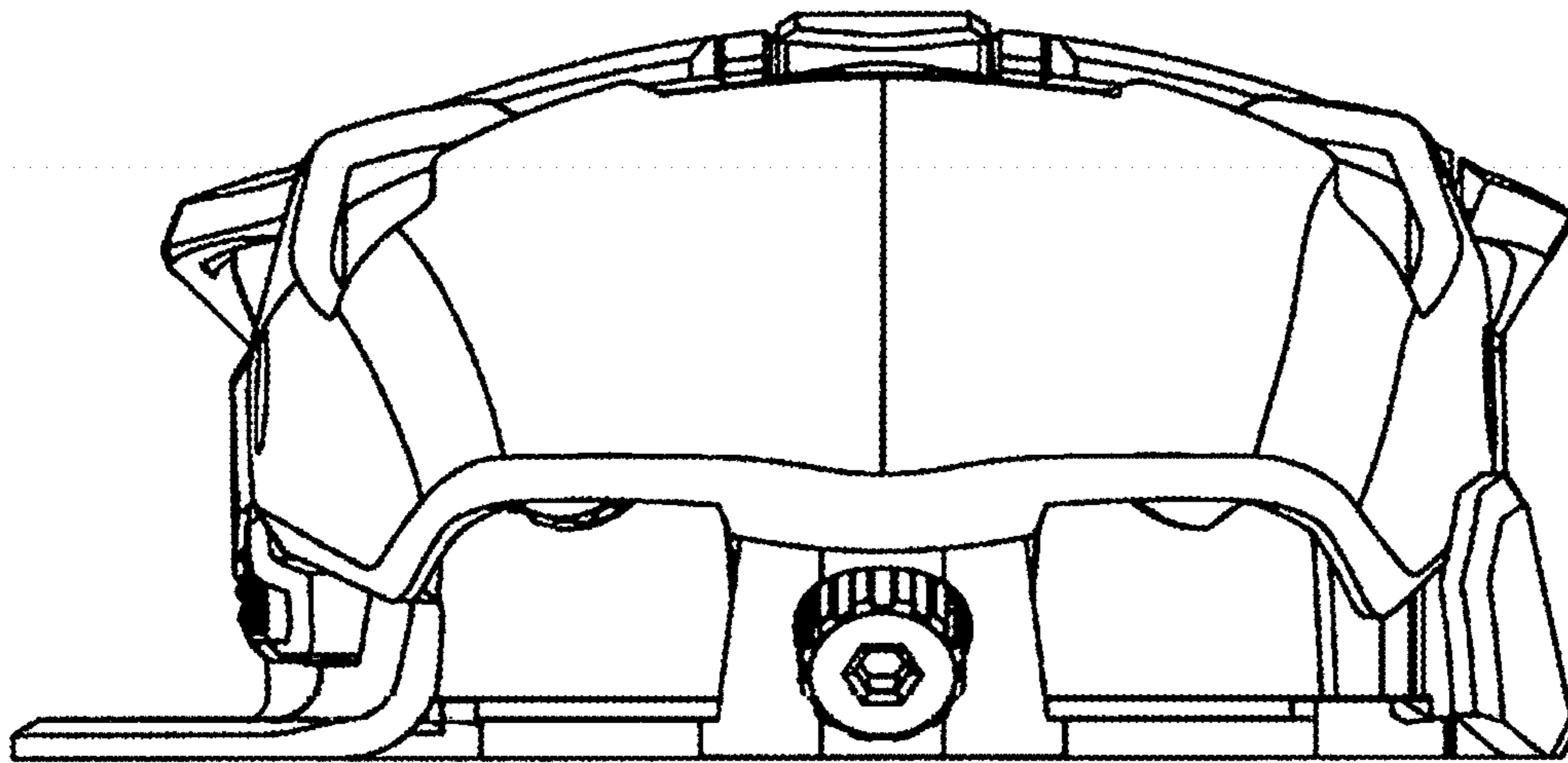

FIG. 6