



US00D868771S

(12) **United States Design Patent** (10) **Patent No.:** **US D868,771 S**
Nagano et al. (45) **Date of Patent:** **** Dec. 3, 2019**

(54) **SERVER FOR DATA**

5/0021; H05K 5/0213; H05K 5/0256;
H05K 5/0243; H05K 5/023; H05K
5/0204

(71) Applicant: **KONICA MINOLTA, INC.**,
Chiyoda-ku, Tokyo (JP)

See application file for complete search history.

(72) Inventors: **Masakazu Nagano**, Nishinomiya (JP);
Yu Iritani, Tokyo (JP); **Thomas
Edward Keen**, London (GB); **Nicholas
Woodley**, London (GB); **Astrid
Nathalie Xavier Vanhuysse**, London
(GB); **Manon Bourette**, London (GB)

(56) **References Cited**

U.S. PATENT DOCUMENTS

D230,738 S * 3/1974 De Luca D14/140.4
D231,464 S * 4/1974 Dalke D14/313
D263,395 S * 3/1982 Karas D13/162
D338,659 S * 8/1993 Clark D14/355
D406,823 S * 3/1999 Dorr D14/353

(Continued)

(73) Assignee: **KONICA MINOLTA, INC.**,
Chiyoda-Ku, Tokyo (JP)

(**) Term: **15 Years**

OTHER PUBLICATIONS

(21) Appl. No.: **29/654,286**

Brown, Matt, The 10 coolest servers of 2017 so far, posted at CRN,
posting date Jul. 20, 2017. Site visited Jul. 30, 2019. URL: <https://
www.crn.com.au/news/the-10-coolest-servers-of-2017-so-far-
468780> (Year: 2017).*

(22) Filed: **Jun. 22, 2018**

(30) **Foreign Application Priority Data**

Dec. 22, 2017 (JP) 2017-028691

(51) **LOC (12) Cl.** **14-02**

(52) **U.S. Cl.**
USPC **D14/301**; D14/313

(58) **Field of Classification Search**
USPC D14/300-304, 308-314, 328, 348-370,
D14/432, 435, 440-441, 443-446,
D14/479-480, 481-483, 140.1, 140.4,
D14/164, 193; D13/123, 133, 146-147,
D13/152, 154-155, 158, 164, 184, 199
CPC G06F 1/181; G06F 1/182; G06F 1/187;
G06F 1/183; G06F 1/184; G06F 1/16;
H05K 7/16; H05K 7/1424; H05K 7/1409;
H05K 7/20; H05K 7/20545; H05K
7/20727; H05K 7/1425; H05K 7/1488;
H05K 7/183; H05K 7/14; H05K 7/20172;
H05K 7/20209; H05K 7/00; H05K
7/20536; H05K 7/20736; H05K 7/20581;
H05K 7/20709; H05K 7/207; H05K
7/20754; H05K 5/00; H05K 5/0004;
H05K 5/0008; H05K 5/0017; H05K

Primary Examiner — Kevin K Rudzinski

Assistant Examiner — Kathleen L Jones

(74) *Attorney, Agent, or Firm* — Buchanan Ingersoll &
Rooney PC

(57) **CLAIM**

The ornamental design for a server for data, as shown and
described.

DESCRIPTION

FIG. 1 is a front elevational view of a server for data
showing our new design;
FIG. 2 is a rear elevational view thereof;
FIG. 3 is a right side elevational view thereof;
FIG. 4 is a left side elevational view thereof;
FIG. 5 is a top plan view thereof;
FIG. 6 is a bottom plan view thereof; and,
FIG. 7 is a perspective view thereof.

1 Claim, 5 Drawing Sheets

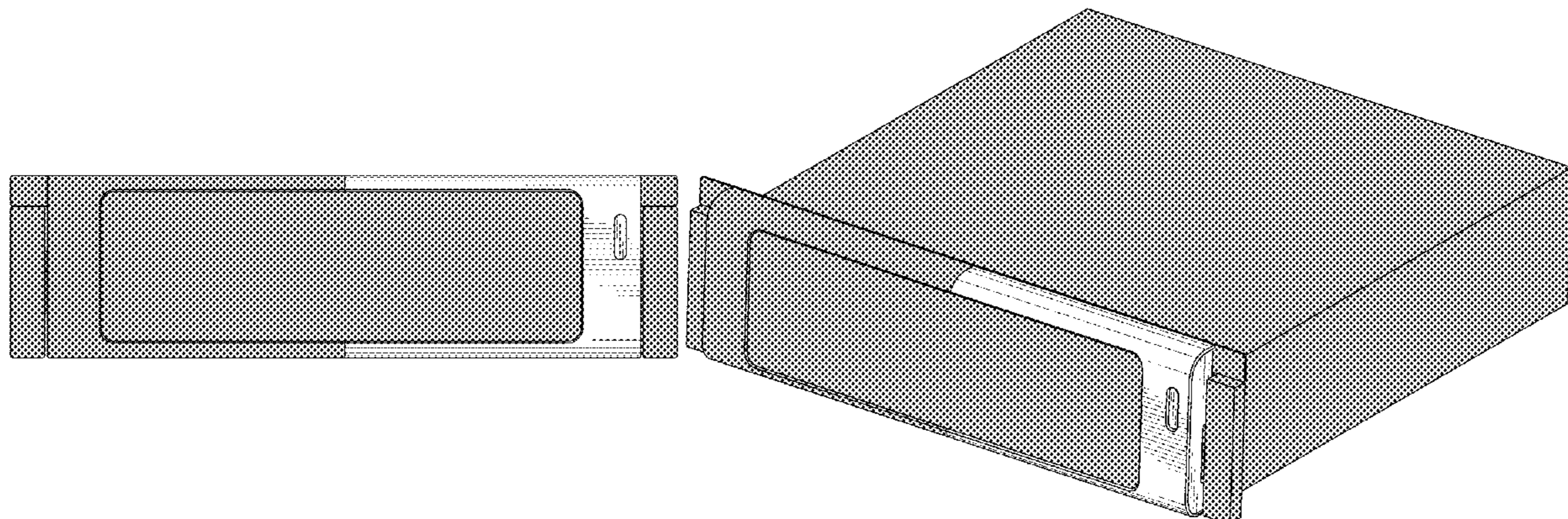

(56)

References Cited

U.S. PATENT DOCUMENTS

D408,409	S	*	4/1999	Ito	D14/502
D494,172	S	*	8/2004	Asai	D14/368
D531,980	S	*	11/2006	Takemasa	D14/167
D534,142	S	*	12/2006	Nakajima	D14/135
D554,595	S	*	11/2007	Riede	D13/164
D588,083	S	*	3/2009	Suzuki	D14/502
D665,379	S	*	8/2012	Behringer	D14/193
D710,821	S	*	8/2014	Marklund	D14/188
D717,292	S	*	11/2014	Koberling	D14/314
D748,093	S	*	1/2016	Russette	D14/356
D748,096	S	*	1/2016	Laessle	D14/439
D754,665	S	*	4/2016	Zhang	D14/432
D761,247	S	*	7/2016	Otsuka	D14/313
D775,121	S	*	12/2016	Suzuki	D14/258
D797,716	S	*	9/2017	Suzuki	D14/258
D805,067	S	*	12/2017	Sparks	D14/332
D840,389	S	*	2/2019	Nagano	D14/301
D849,001	S	*	5/2019	Nokuo	D14/355
2003/0076652	A1	*	4/2003	Ahn	G06F 1/1616 361/679.02
2003/0151334	A1	*	8/2003	Chen	G06F 1/181 312/223.2
2006/0164814	A1	*	7/2006	Titus	G06F 1/184 361/724

* cited by examiner

FIG.1

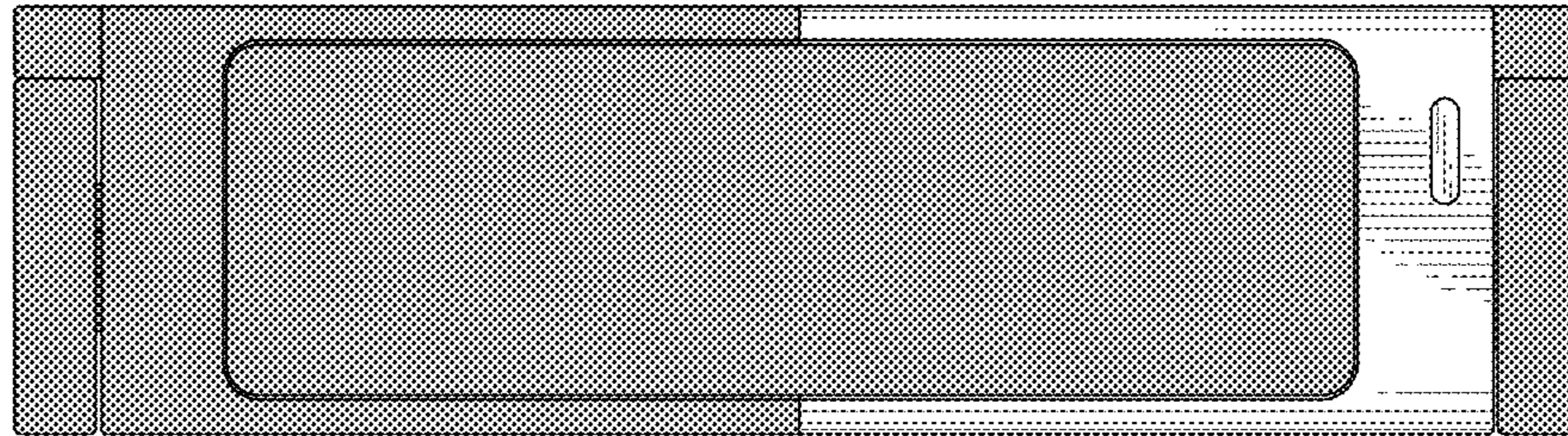

FIG.2

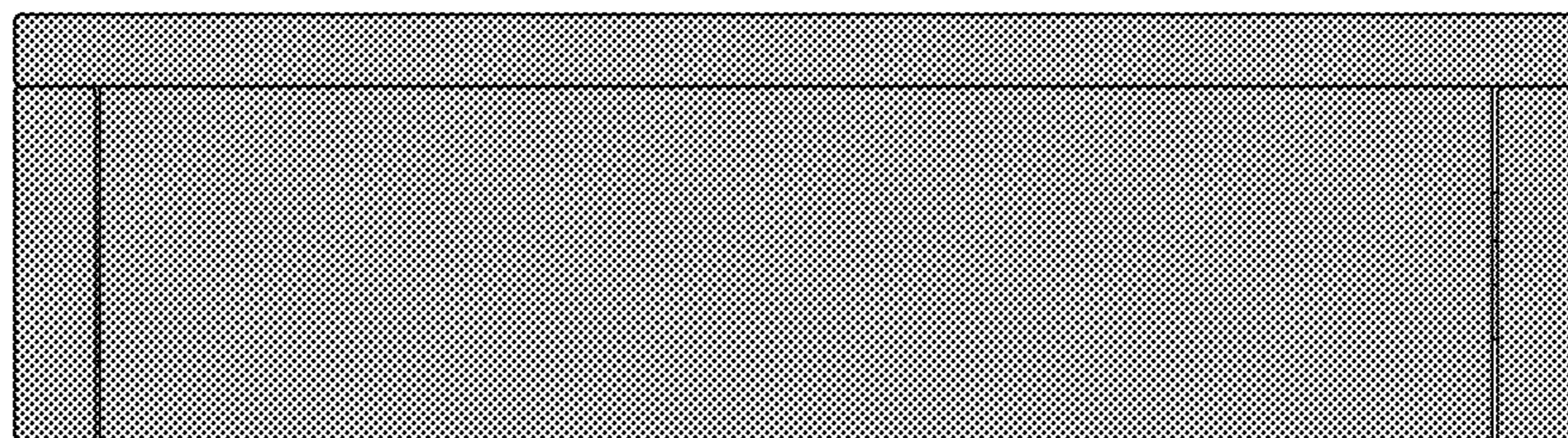

FIG.3

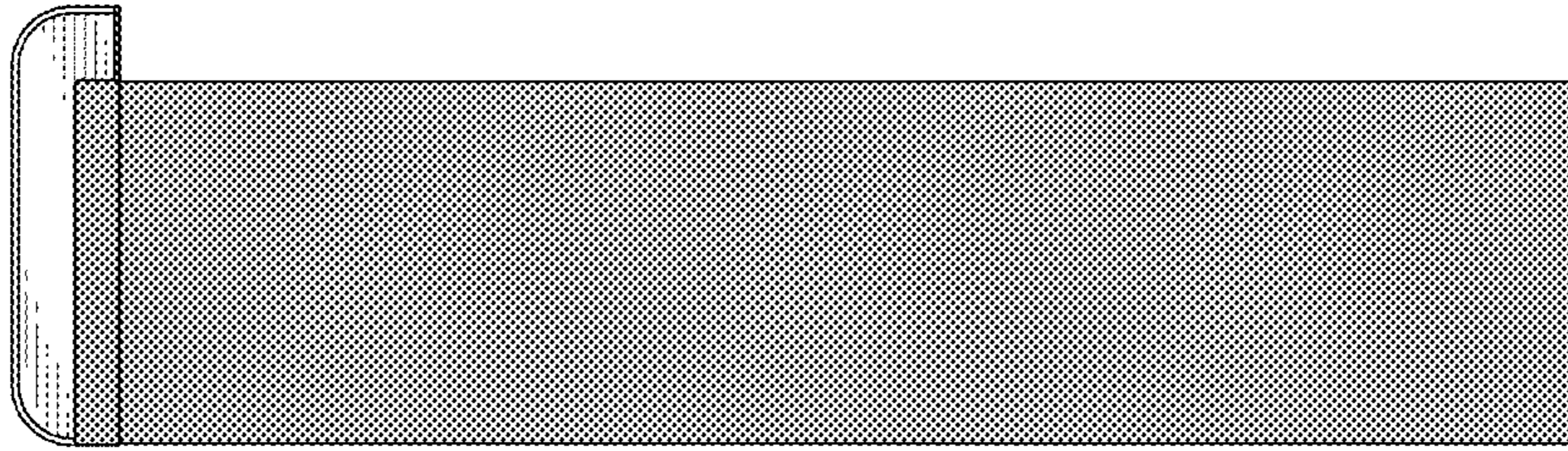

FIG.4

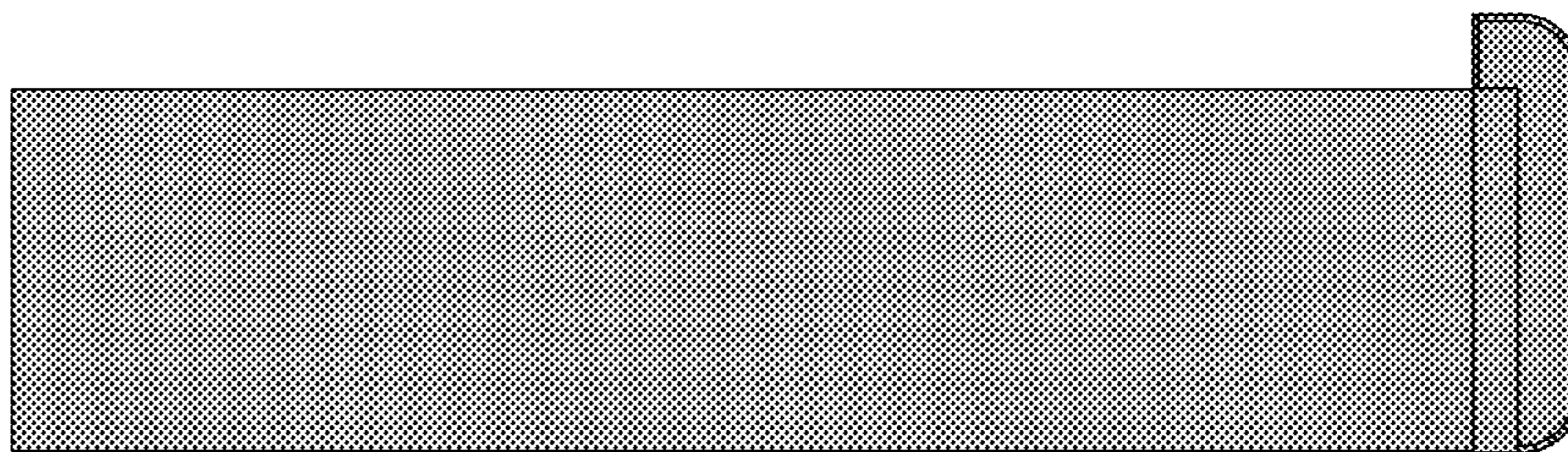

FIG. 5

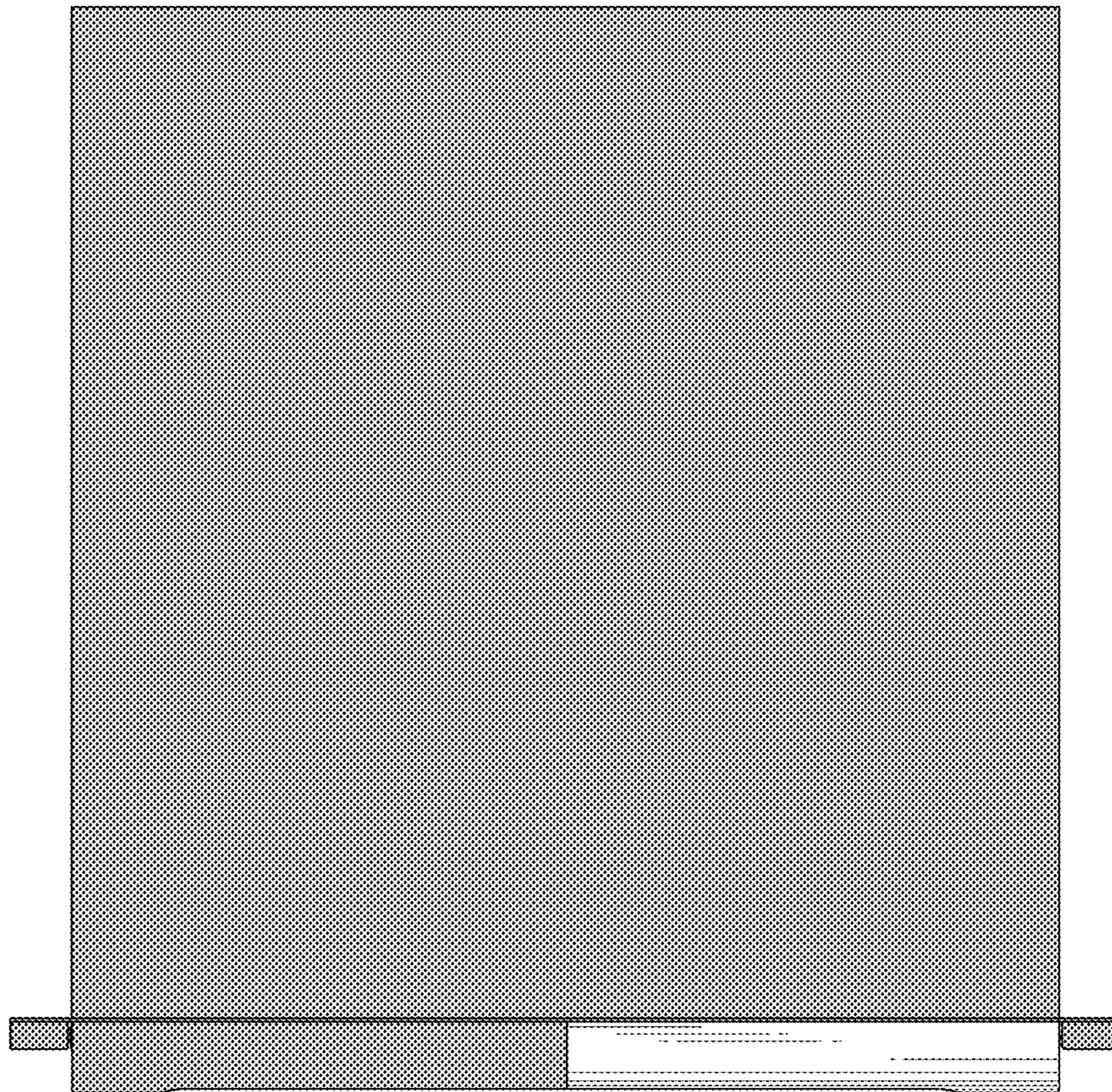

FIG. 6

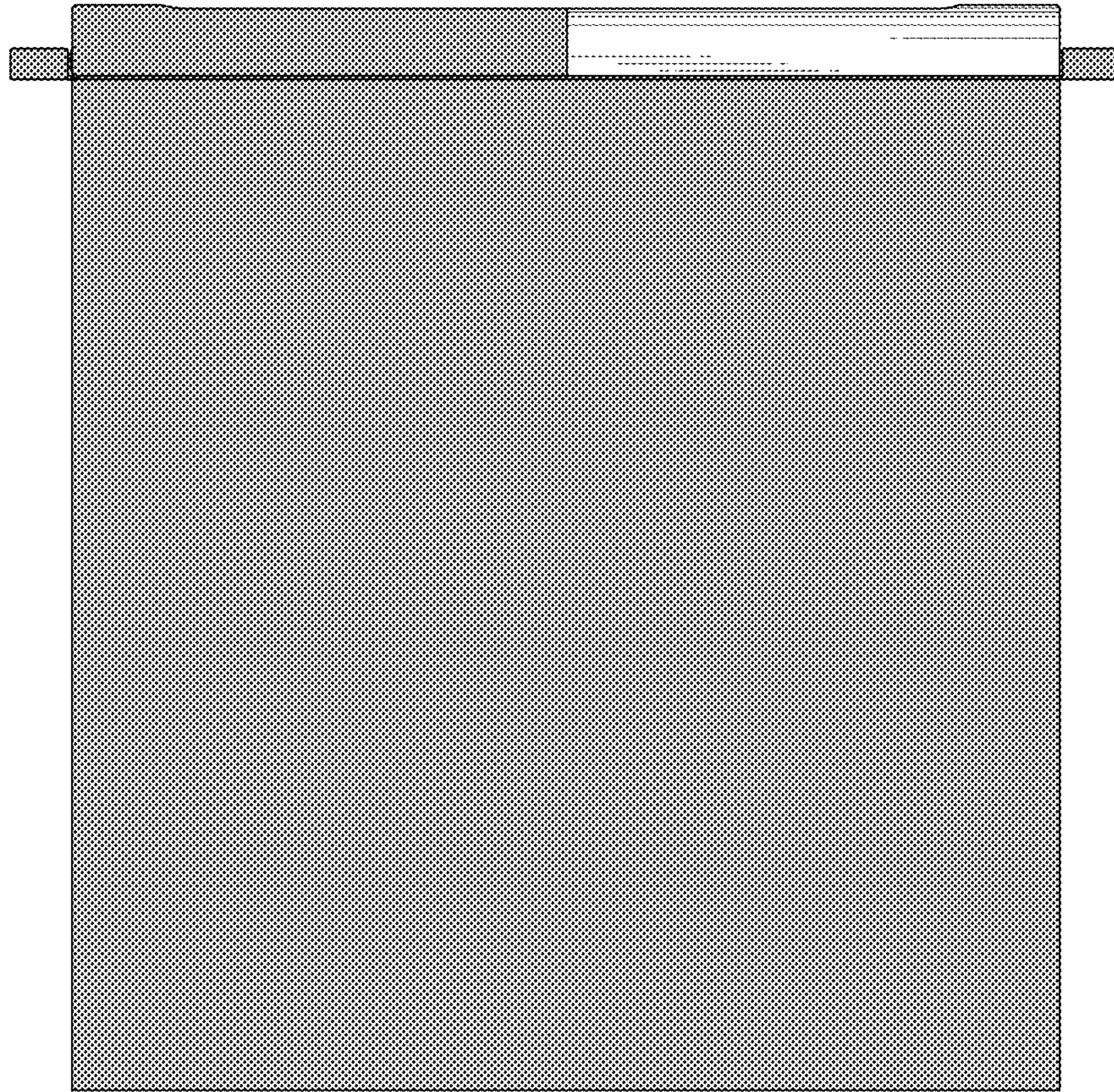

FIG. 7

