



US00D868766S

(12) **United States Design Patent** (10) **Patent No.:** **US D868,766 S**
Kim (45) **Date of Patent:** **** *Dec. 3, 2019**

(54) **CASE FOR ELECTRONIC COMMUNICATIONS DEVICE**
(71) Applicant: **SPIGEN KOREA CO., LTD.**, Seoul (KR)
(72) Inventor: **Seungjoo Kim**, Seoul (KR)
(73) Assignee: **SPIGEN KOREA CO., LTD.**, Seoul (KR)
(*) Notice: This patent is subject to a terminal disclaimer.
(**) Term: **15 Years**
(21) Appl. No.: **29/617,201**
(22) Filed: **Sep. 12, 2017**
(51) **LOC (12) Cl.** **14-03**
(52) **U.S. Cl.**
USPC **D14/250**
(58) **Field of Classification Search**
USPC D3/218, 232, 233, 239, 242, 245–251, D3/269, 273, 301, 303; D13/103, 107, D13/108, 119; D14/137, 138 R, 138 AA, D14/138 C, 138 G, 203.3–203.7, 217, D14/238.1, 247, 248, 250, 251–253, 440
CPC H04B 1/3888; H04M 1/0283; H04M 1/0202; A45C 1/06; A45C 2011/002; A45C 11/00; A45F 2005/028; A45F 2200/0525
See application file for complete search history.

D712,892 S 9/2014 Hong et al.
D714,276 S 9/2014 Hu et al.
D718,291 S 11/2014 Hong
D721,360 S 1/2015 Laffon de Mazieres et al.
D723,531 S * 3/2015 Katzke D14/250
D746,275 S 12/2015 Mohammad
D746,805 S * 1/2016 Kim D14/250
D747,708 S * 1/2016 Roberts D14/250
D756,345 S * 5/2016 Roberts D14/250
D757,702 S 5/2016 Kanazawa
D757,703 S 5/2016 Kanazawa
D757,704 S * 5/2016 Roberts D14/250
D760,710 S * 7/2016 Ozolins D14/250
D761,774 S 7/2016 Liang
D761,779 S * 7/2016 Tsai D14/250
D763,841 S 8/2016 Kim
D765,634 S 9/2016 McCray et al.
D772,210 S 11/2016 Igarashi
D772,854 S 11/2016 Igarashi
D775,619 S 1/2017 Tien
D776,104 S 1/2017 Tien
D777,715 S 1/2017 Sawaya
D780,167 S 2/2017 Tien
D781,835 S 3/2017 Kim et al.
D781,839 S 3/2017 Kim et al.
D788,090 S 5/2017 Kim
9,723,735 B1 * 8/2017 Kim F16M 13/00
D800,105 S * 10/2017 Roberts D14/250
D801,325 S * 10/2017 Kim D14/250
D803,823 S * 11/2017 Feng D14/250
2013/0257240 A1 * 10/2013 Hong H04B 1/3888 312/223.1
2016/0101902 A1 4/2016 Kim

(56) **References Cited**
U.S. PATENT DOCUMENTS
D619,361 S 7/2010 Andre
D663,263 S * 7/2012 Gupta D13/103
D669,071 S 10/2012 Akana et al.
D670,281 S 11/2012 Corpuz et al.
D671,930 S 12/2012 Akana et al.
D676,837 S 2/2013 Rothbaum et al.
D679,271 S 4/2013 Liu
D706,254 S 6/2014 Chang
D706,754 S * 6/2014 Goradesky D14/250

OTHER PUBLICATIONS

Speck’s CandyShell Clear, Sparkle Edition Posting date: May 26, 2016, [online][visited Mar. 28, 2018] (Year: 2016).*
Transparent clear iphone x case, posting date Jul. 22, 2017, [site visited Mar. 20, 2018] (Year: 2017).*
“iPhone SE Case, for Apple iPhone 5S/5 Case, ROCK [Royce] Anti-scratch Drop Protection Slim Fit Dual Layered Heavy Duty Armor Hybrid Hard PC + Soft TPU Protective Shell Case—Champagne Gold/Black”, <https://www.amazon.com/dp/B014A8AM7I>, Published on Oct. 16, 2015, Downloaded on Jan. 30, 2017.
George Tinari, “Caseology review: Testing 4 of the nicest iPhone 6s cases available”, <https://www.cultofmac.com/399325/caseology-review/>. Published on Nov. 28, 2015, Downloaded on Jan. 30, 2017.
“iPhone 6S Plus Case, Caseology [Wavelength Series] Slim Fit Military-Grade Drop Protection [Navy Blue] for Apple iPhone 6S

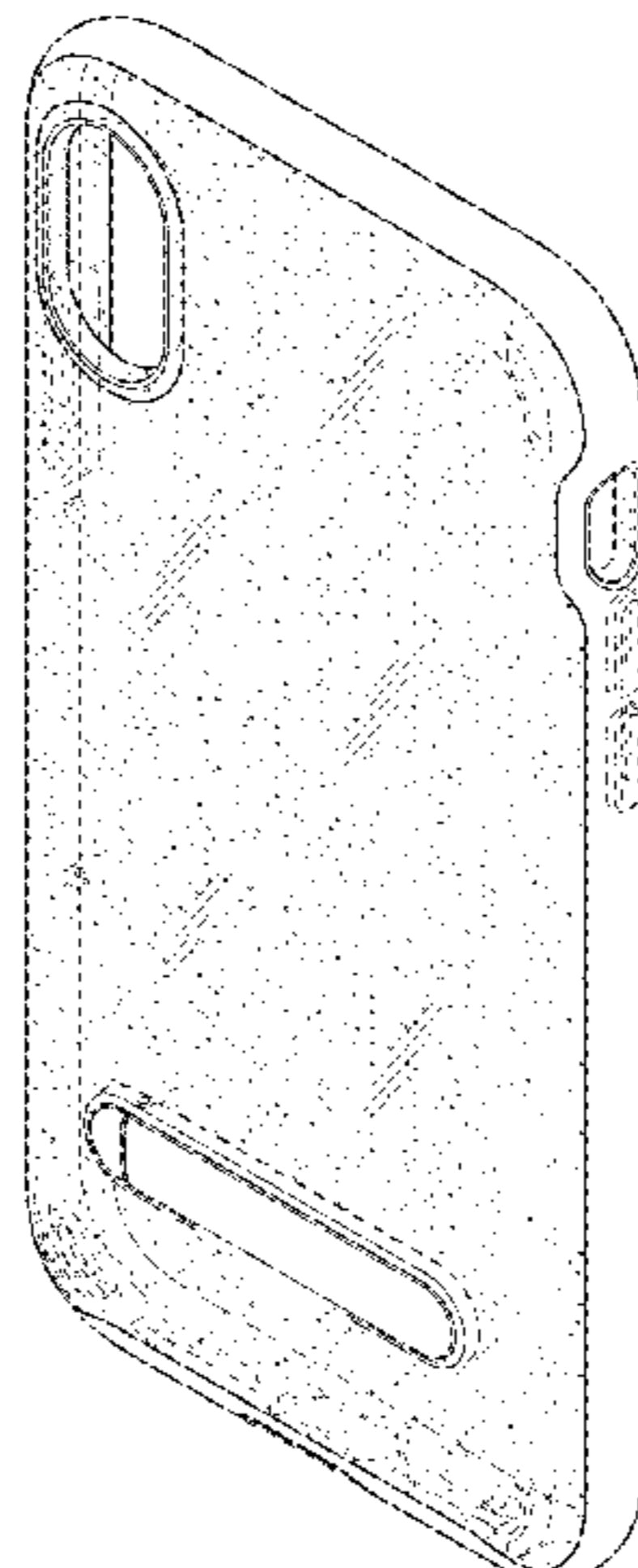

Plus (2015) & iPhone 6 Plus (2014)", <https://www.amazon.com/dp/B013W2C77G>, Published on Sep. 10, 2015, Downloaded on Mar. 13, 2018.

"Spigen Neo Hybrid 6S Case with Flexible Inner Protection and Reinforced Hard Bumper Frame for iPhone 6S 2015—Gunmetal", <https://www.amazon.com/dp/B010MVIZTE>, Published on Sep. 1, 2015, Downloaded on Dec. 18, 2018.

"iPhone 6s Case, Spigen [Neo Hybrid EX] Premium Bumper [Rose Gold] Clear TPU / PC Frame Slim Dual Layer Premium Case for iPhone 6 (2014) / 6s (2015)—Rose Gold (SGP11725)", <https://www.amazon.com/dp/B012PKV30S>, Published on Aug. 28, 2015, Downloaded on Dec. 18, 2018.

"Spigen Neo Hybrid Carbon iPhone 6S Case with Carbon Fiber Design and Reinforced Hard Bumper Frame for iPhone 6S / iPhone 6 (2015)—Reventon Yellow", <https://www.amazon.com/dp/B010MVJ5O8>, Published on Sep. 1, 2015, Downloaded on Dec. 18, 2018.

"Spigen Neo Hybrid Galaxy S6 Edge Case with Flexible Inner Protection and Reinforced Hard Bumper Frame for Galaxy S6 Edge 2015—Gunmetal", <https://www.amazon.com/dp/B00SV635BG>, Published on Mar. 19, 2015, Downloaded on Dec. 18, 2018.

"Spigen Neo Hybrid EX iPhone 6 Case with Flexible Inner Bumper and Reinforced Hard Frame for iPhone 6S/iPhone 6—EX Satin Silver", <https://www.amazon.com/dp/B00LL6RZ3C>, Published on Sep. 6, 2014, Downloaded on Dec. 18, 2018.

"Spigen Neo Hybrid Galaxy S6 Case with Flexible Inner Protection and Reinforced Hard Bumper Frame for Galaxy S6 2015—Satin Silver", <https://www.amazon.com/dp/B00QU4Q31A>, Published on Mar. 6, 2015, Downloaded on Dec. 18, 2018.

"Spigen Neo Hybrid CC Galaxy S6 Case with Flexible Inner Casing and Reinforced Hard Bumper Frame for Galaxy S6 2015—Satin Silver", <https://www.amazon.com/dp/B00UMDOZLU>, Published on Mar. 25, 2015, Downloaded on Dec. 18, 2018.

"Spigen Neo Hybrid Nexus 6 Case with Flexible Inner Protection and Reinforced Hard Bumper Frame for Google Nexus 6 2014—Dante Red", <https://www.amazon.com/dp/B00OH4HKGC>, Published on Nov. 16, 2014, Downloaded on Dec. 18, 2018.

"Spigen Neo Hybrid EX Nexus 6P Case with Flexible Inner Bumper and Reinforced Hard Frame for Nexus 6P 2015—Gunmetal", <https://www.amazon.com/dp/B0184I8Z4W>, Published on Oct. 20, 2015, Downloaded on Dec. 18, 2018.

"Spigen Neo Hybrid Crystal Galaxy Note 5 Case with Flexible Inner Casing and Reinforced Hard Bumper Frame for Galaxy Note 5 2015—Champagne Gold", <https://www.amazon.com/dp/B010MWIG1K>, Published on Aug. 22, 2015, Downloaded on Dec. 18, 2018.

"Spigen Neo Hybrid EX iPhone 6S Plus Case with Flexible Inner Bumper and Reinforced Hard Frame for iPhone 6S Plus/iPhone 6 Plus—Champagne Gold", <https://www.amazon.com/dp/B010MVRRI6>, Published on Sep. 4, 2015, Downloaded on Dec. 18, 2018.

"Spigen Neo Hybrid Carbon Galaxy S6 Edge Plus Case with Carbon Fiber Design and Reinforced Hard Bumper Frame for Galaxy S6 Edge Plus 2015—Dante Red", <https://www.amazon.com/dp/B010MWHZS0>, Published on Aug. 18, 2015, Downloaded on Dec. 18, 2018.

"Spigen Neo Hybrid CC Galaxy S6 Edge Case with Flexible Inner Casing and Reinforced Hard Bumper Frame for Galaxy S6 Edge 2015—Blue Topaz", <https://www.amazon.com/dp/B00USAPGKQ>, Published on Apr. 4, 2015, Downloaded on Dec. 18, 2018.

"Spigen Neo Hybrid iPhone 6 Case with Flexible Inner Protection and Reinforced Hard Bumper Frame for iPhone 6S / iPhone 6—Gunmetal", <https://www.amazon.com/dp/B00LL6ZPXV>, Published on Aug. 28, 2014, Downloaded on Dec. 18, 2018.

"Spigen Neo Hybrid Carbon iPhone 6S Plus Case with Carbon Fiber Design and Reinforced Hard Bumper Frame for iPhone 6S Plus 2015—Gunmetal", <https://www.amazon.com/dp/B010MVRGMQ>, Published on Sep. 11, 2015, Downloaded on Dec. 18, 2018.

Dannny Winget, "Spigen SGP Neo Hybrid for Galaxy Note 3 Review", <https://www.youtube.com/watch?v=W80JtBDSckk>, Published on Nov. 3, 2013, Downloaded on Dec. 20, 2018.

"Spigen Neo Hybrid Galaxy S4 Case with Flexible Inner Protection and Reinforced Hard Bumper Frame for Galaxy S4 2013—Dante

Red", <https://www.amazon.com/dp/B00BYJX11Y>, Published on May 9, 2013, Downloaded on Jan. 22, 2019.

"Spigen Neo Hybrid Galaxy S5 Case with Flexible Inner Protection and Reinforced Hard Bumper Frame for Samsung Galaxy S5 2014—Electric Blue", <https://www.amazon.com/dp/B00I3UWJJY>, Published on Apr. 12, 2014, Downloaded on Jan. 22, 2019.

Spigen, "Installation video of Spigen SGP Case Neo Hybrid EX on iPhone 5", <https://www.youtube.com/watch?v=X2GAS9FT6U4>, Published on Oct. 11, 2012, Downloaded on Feb. 20, 2019.

Spigen, "Installation video of SGP Neo Hybrid Case", <https://www.youtube.com/watch?v=mVASro4MsEg>, Published on Oct. 30, 2009, Downloaded on Feb. 21, 2019.

Spigen, "Installation video of SGP Case Neo Hybrid EX on Galaxy S2", <https://www.youtube.com/watch?v=ZPhSIAUxXWg>, Published on Aug. 24, 2011, Downloaded on Feb. 21, 2019.

Spigen, "Installation video of SGP Neo Hybrid2", https://www.youtube.com/watch?v=y5_NdOVOfZo, Published on May 25, 2010, Downloaded on Feb. 21, 2019.

Spigen, "Neo Hybrid Case for Galaxy S3", <https://www.youtube.com/watch?v=IgpahRniVku>, Published on Jun. 27, 2012, Downloaded on Feb. 21, 2019.

metagmers, "Spigen Neo Hybrid iPhone 5 & 5s Case Review", <https://www.youtube.com/watch?v=vTvTYZfSmal>, Published on Jul. 21, 2013, Downloaded on Feb. 21, 2019.

"Caseology Parallax Series iPhone 7 Plus / 8 Plus Cover Case with Design Slim Protective for Apple iPhone 7 Plus (2016) / iPhone 8 Plus (2017)—Matte Black", <https://www.amazon.com/dp/B01LY50PST>, Published on Sep. 9, 2016, Downloaded on Mar. 13, 2018.

"Spigen Neo Hybrid Galaxy S7 Case with Flexible Inner Protection and Reinforced Hard Bumper Frame for Samsung Galaxy S7 2016—Gunmetal", <https://www.amazon.com/dp/B01B1I6J0E>, Published on Feb. 27, 2016, Downloaded on Dec. 18, 2018.

"Spigen Neo Hybrid Galaxy S7 Edge Case with Flexible Inner Protection and Reinforced Hard Bumper Frame for Samsung Galaxy S7 Edge 2016—Satin Silver", <https://www.amazon.com/dp/B01B1I6JMM>, Published on Feb. 27, 2016, Downloaded on Dec. 18, 2018.

"Spigen Neo Hybrid iPhone 7 Case with Flexible Inner Protection and Reinforced Hard Bumper Frame for iPhone 7 2016—Gunmetal", <https://www.amazon.com/dp/B01GIVXKUG>, Published on Sep. 8, 2016, Downloaded on Dec. 18, 2018.

"Spigen Neo Hybrid Crystal iPhone SE Case with Flexible Inner Casing and Reinforced Hard Bumper Frame for iPhone SE 2016—Rose Gold", <https://www.amazon.com/dp/B01BEJB7TI>, Published on Apr. 7, 2016, Downloaded on Dec. 18, 2018.

"Spigen Neo Hybrid Crystal Galaxy S7 Edge Case with Flexible Inner Casing and Reinforced Hard Bumper Frame for Samsung Galaxy S7 Edge 2016—Satin Silver", <https://www.amazon.com/dp/B01A7IDQV4>, Published on Feb. 22, 2016, Downloaded on Dec. 18, 2018.

"Spigen Neo Hybrid Crystal Galaxy S7 Case with Flexible Inner Casing and Reinforced Hard Bumper Frame for Samsung Galaxy S7 2016—Champagne Gold", <https://www.amazon.com/dp/B01B29WCOY>, Published on Mar. 3, 2016, Downloaded on Dec. 18, 2018.

"Spigen Neo Hybrid OnePlus 3 Case/OnePlus 3T Case with Flexible Inner Protection and Reinforced Hard Bumper Frame for OnePlus 3 2016—Gunmetal", <https://www.amazon.com/dp/B01H3PF76Q>, Published on Aug. 9, 2016, Downloaded on Dec. 18, 2018.

"Spigen Neo Hybrid Crystal iPhone 7 Plus Case with Flexible Casing and Hard Bumper Frame for Apple iPhone 7 Plus 2016—Champagne Gold", <https://www.amazon.com/dp/B01GOWHKXI>, Published on Sep. 8, 2016, Downloaded on Dec. 18, 2018.

"Spigen Neo Hybrid Crystal LG G5 Case with Flexible Inner Casing and Reinforced Hard Bumper Frame for LG G5 2016—Champagne Gold", <https://www.amazon.com/dp/B01B1GQKIC>, Published on Apr. 17, 2016, Downloaded on Dec. 18, 2018.

* cited by examiner

Primary Examiner — Susan E Krakower
Assistant Examiner — L. A. Grabenstetter
(74) *Attorney, Agent, or Firm* — Heedong Chae; Lucem,
PC

(57) **CLAIM**

The ornamental design for a case for electronic communications device, as shown and described.

DESCRIPTION

FIG. 1 is a front perspective view of a case for electronic communications device showing my new design;
FIG. 2 is a rear perspective view thereof;
FIG. 3 is a three-dimensional view of the case with a support leg extended thereof;
FIG. 4 is a front elevational view thereof;
FIG. 5 is a rear elevational view thereof;
FIG. 6 is a left side elevational view thereof;
FIG. 7 is a right side elevational view thereof;
FIG. 8 is a top plan view thereof;
FIG. 9 is a bottom plan view thereof;
FIG. 10 is a front perspective view of the inner shell of the case;
FIG. 11 is a rear perspective view of the inner shell of the case;

FIG. 12 is a front perspective view of the outer frame of the case;

FIG. 13 is a rear perspective view of the outer frame of the case;

FIG. 14 is an exploded front perspective view, showing the transparent inner shell, the support leg, and the outer frame of the case;

FIG. 15 is an exploded rear perspective view, showing the transparent inner shell, the support leg, and the outer frame of the case;

FIG. 16 is an enlarged front perspective view of the support leg of the case; and,

FIG. 17 is an enlarged rear perspective view of the support leg of the case.

Although the case for electronic communications device, in which the claimed design is embodied, consists of an inner shell, an outer frame, and a support leg, the claim is directed to the ornamental appearance in its entirety, and does not extend to the ornamental appearance of each of the individual components.

The broken lines, and unshaded surfaces bounded by broken lines, depict parts of the article's appearance that form no part of the claimed design.

1 Claim, 17 Drawing Sheets

FIG. 1

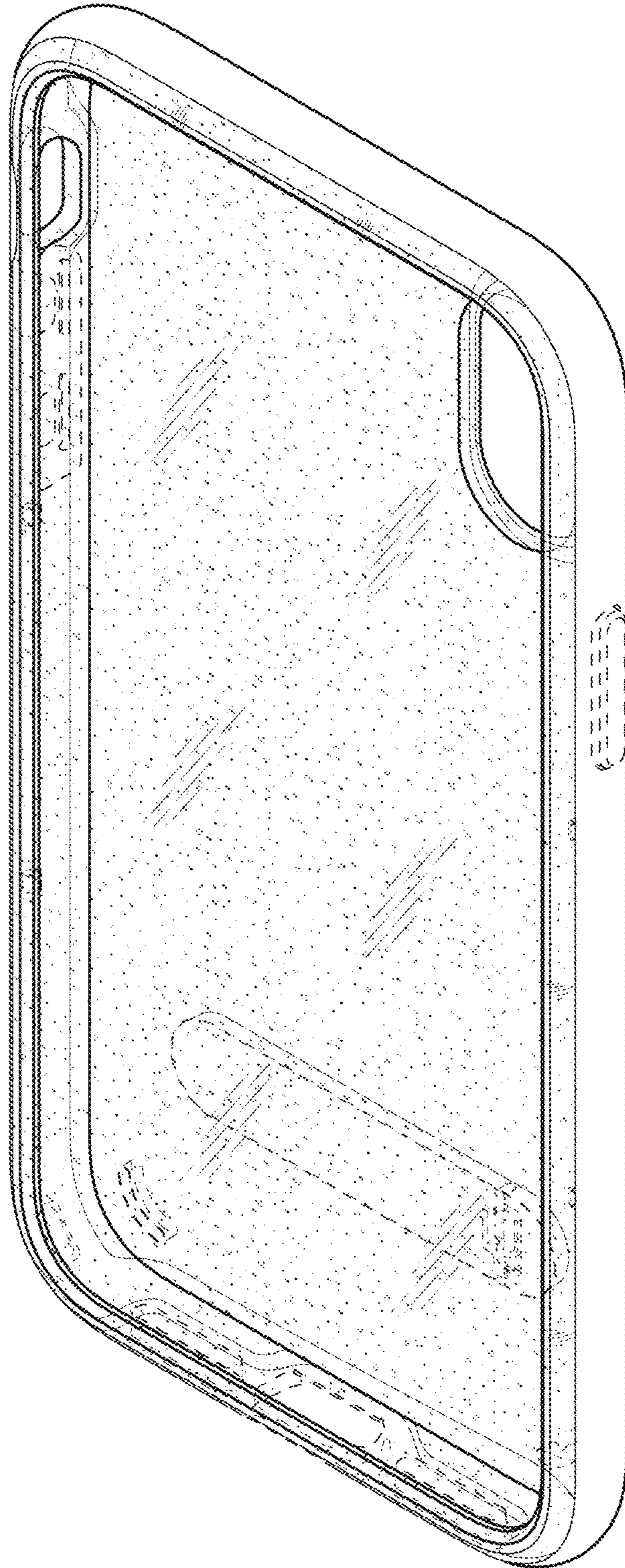

FIG. 2

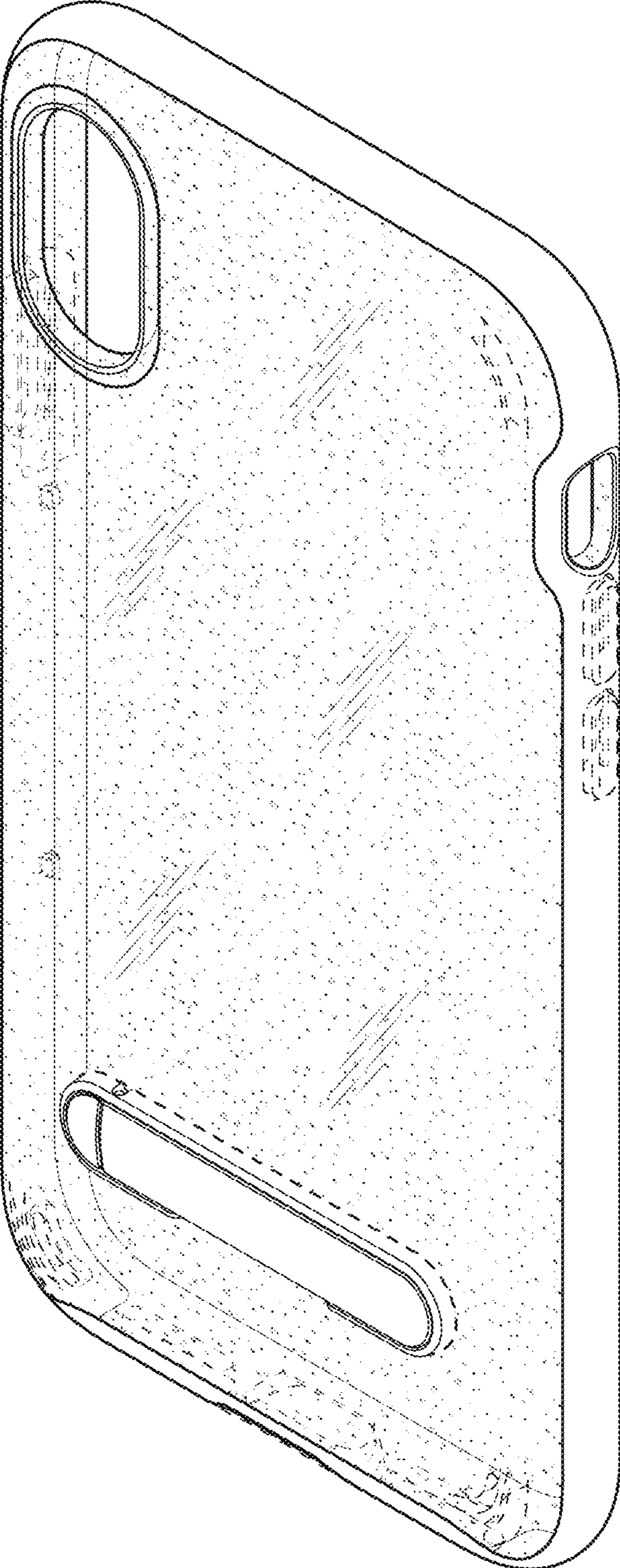

FIG. 3

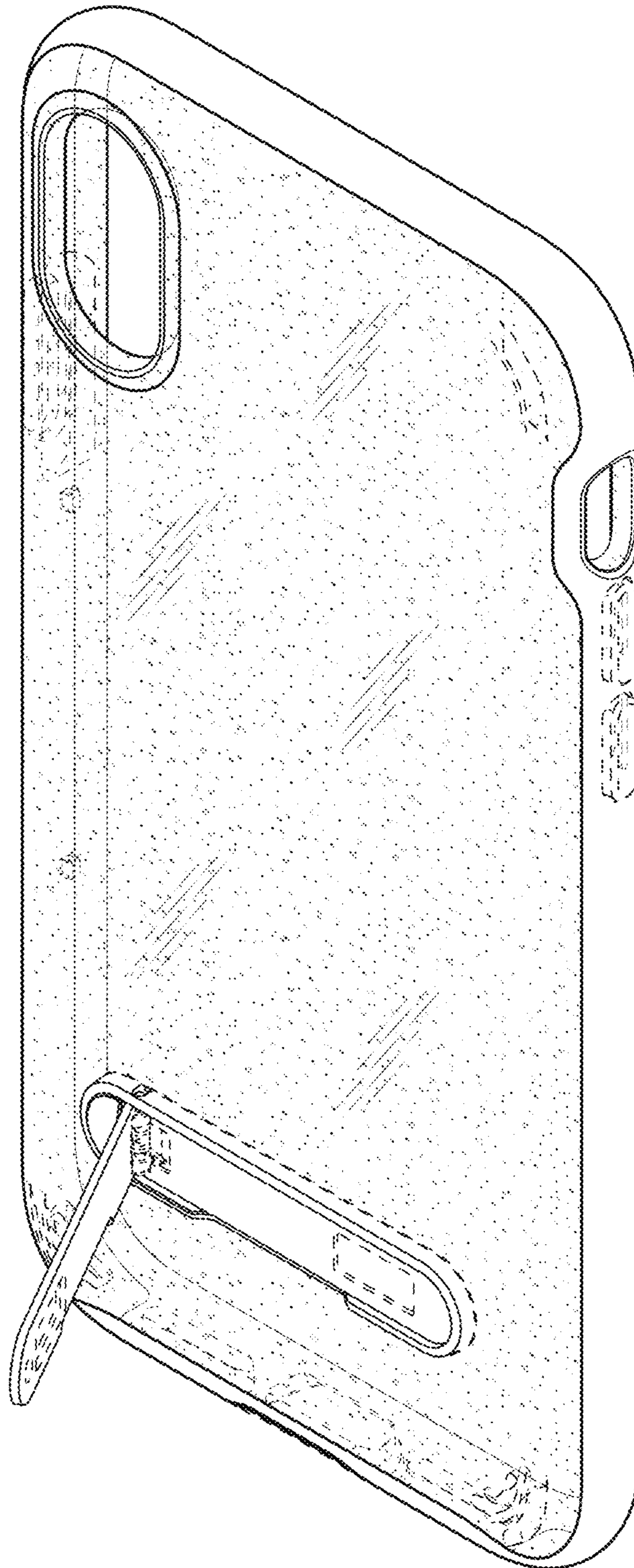

FIG. 4

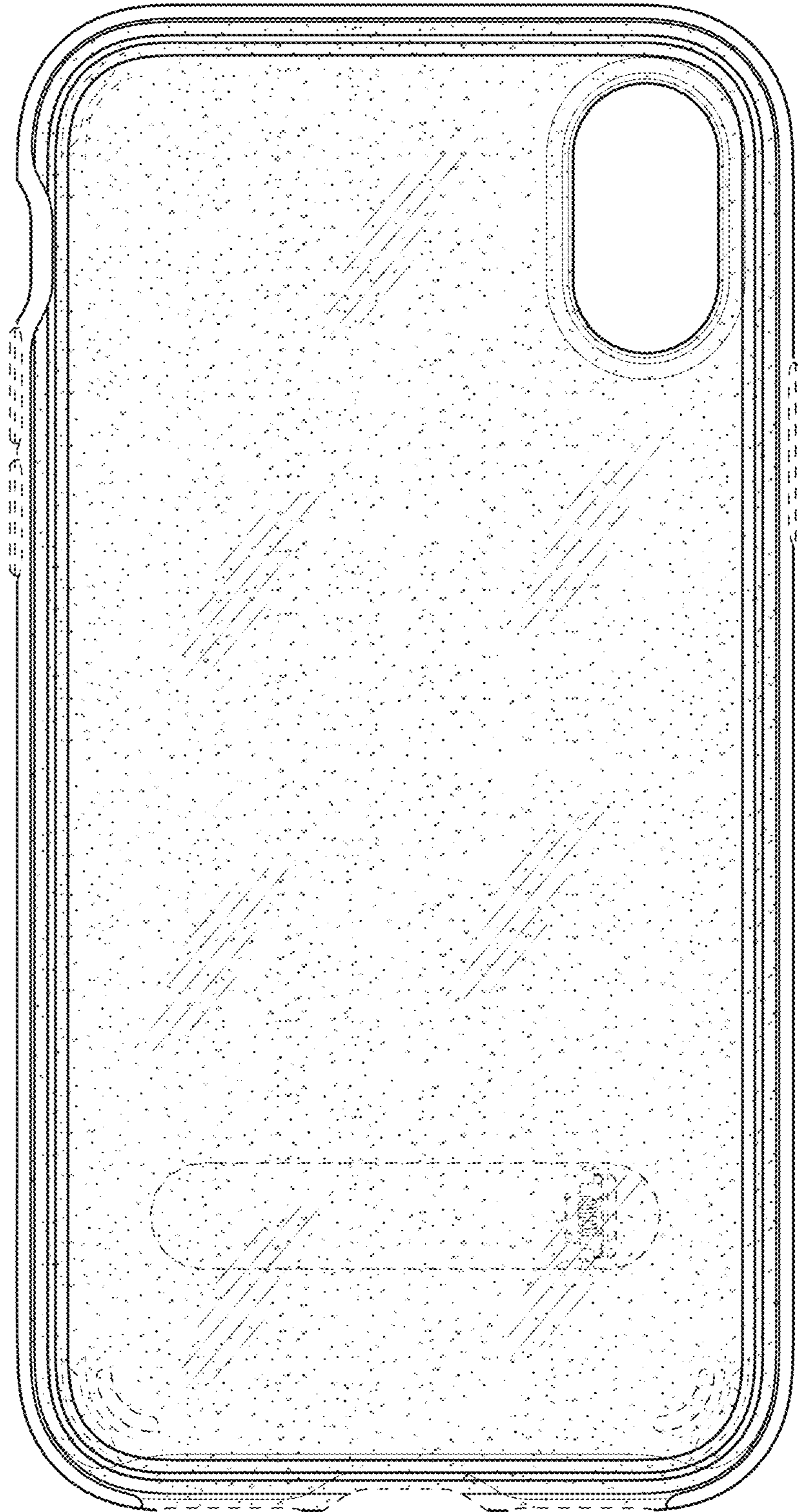

FIG. 5

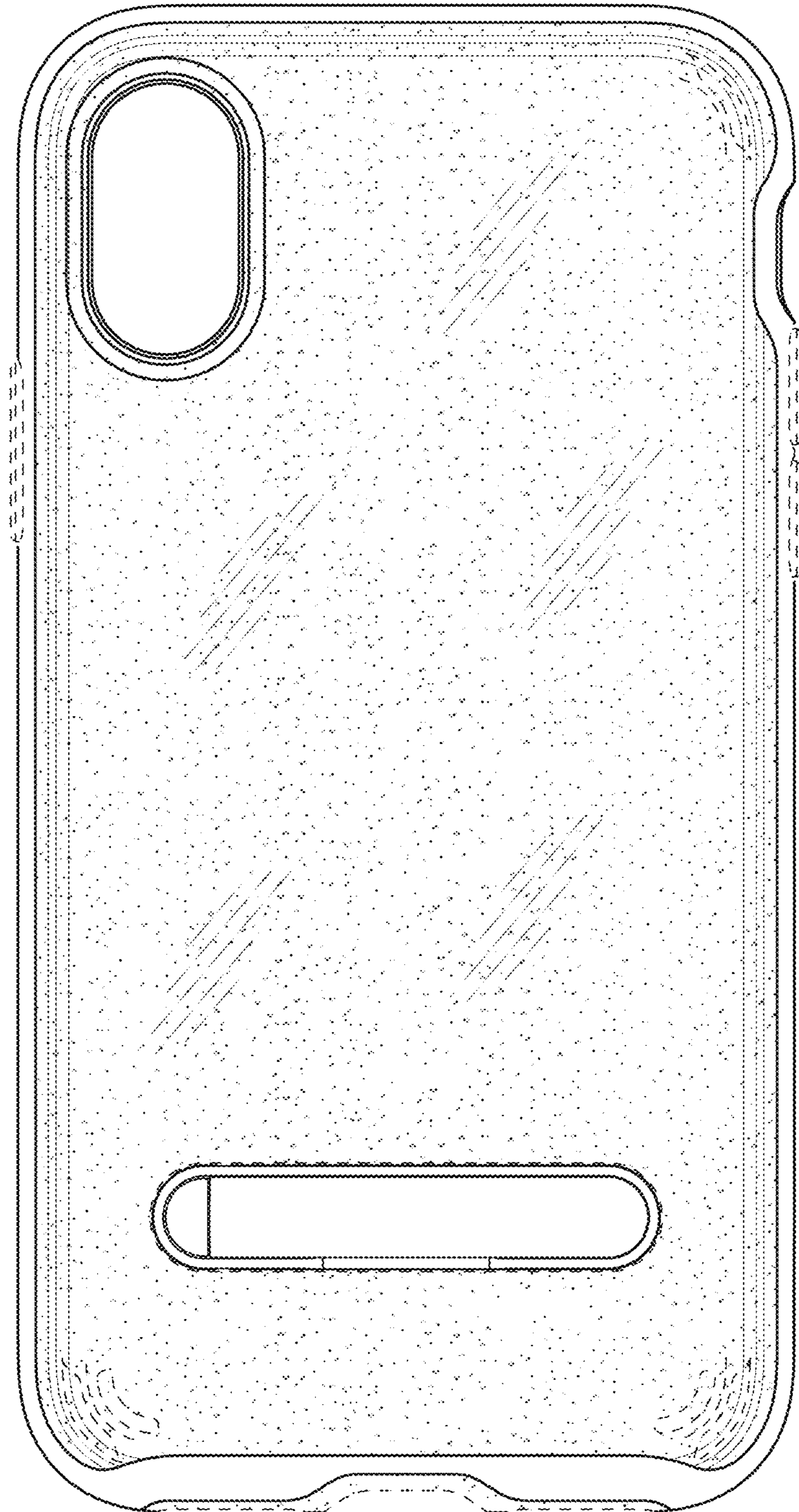

FIG. 6

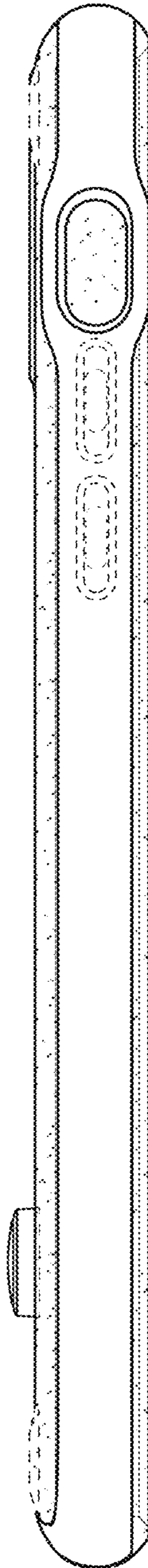

FIG. 7

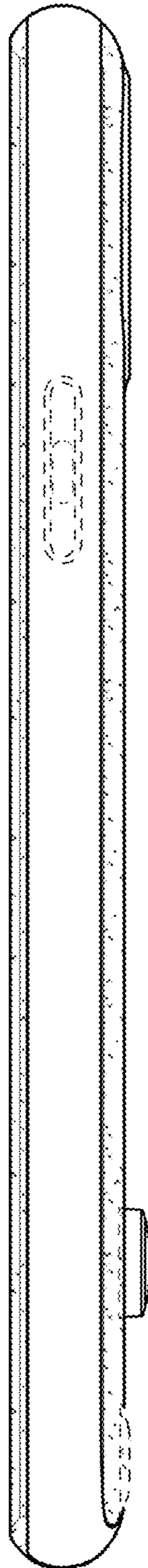

FIG. 8

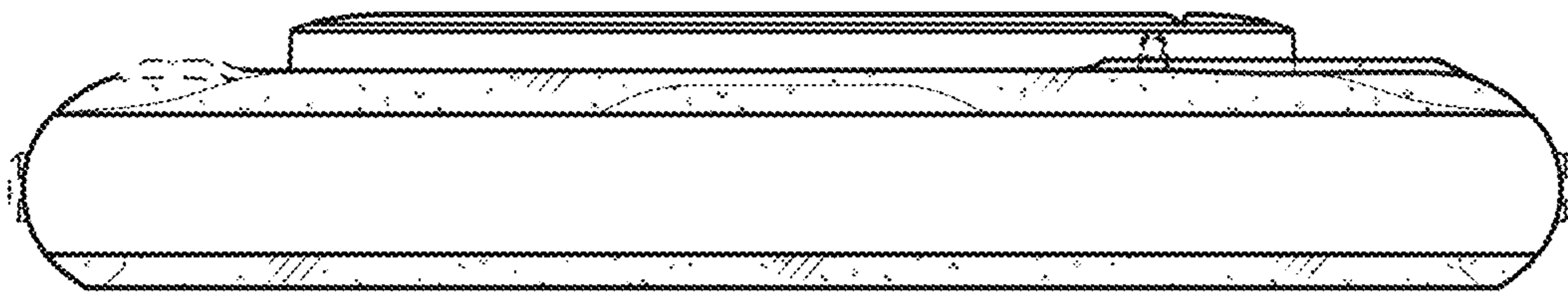

FIG. 9

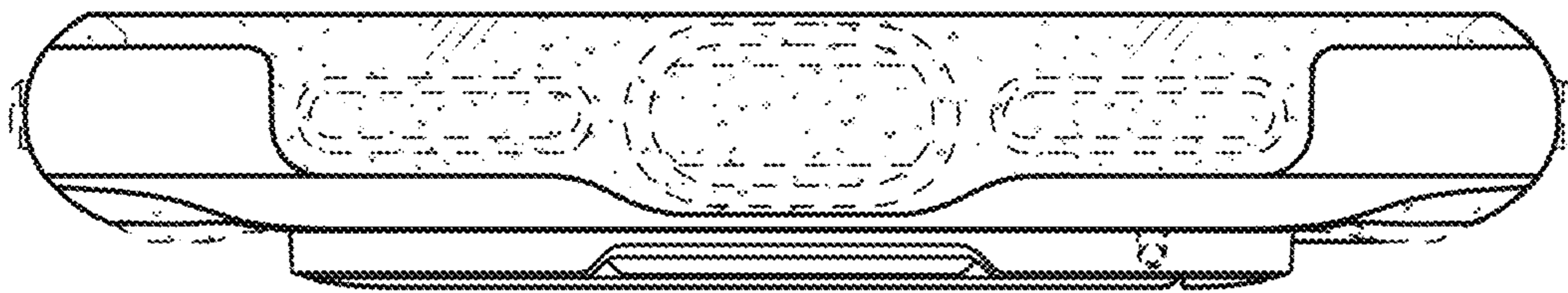

FIG. 10

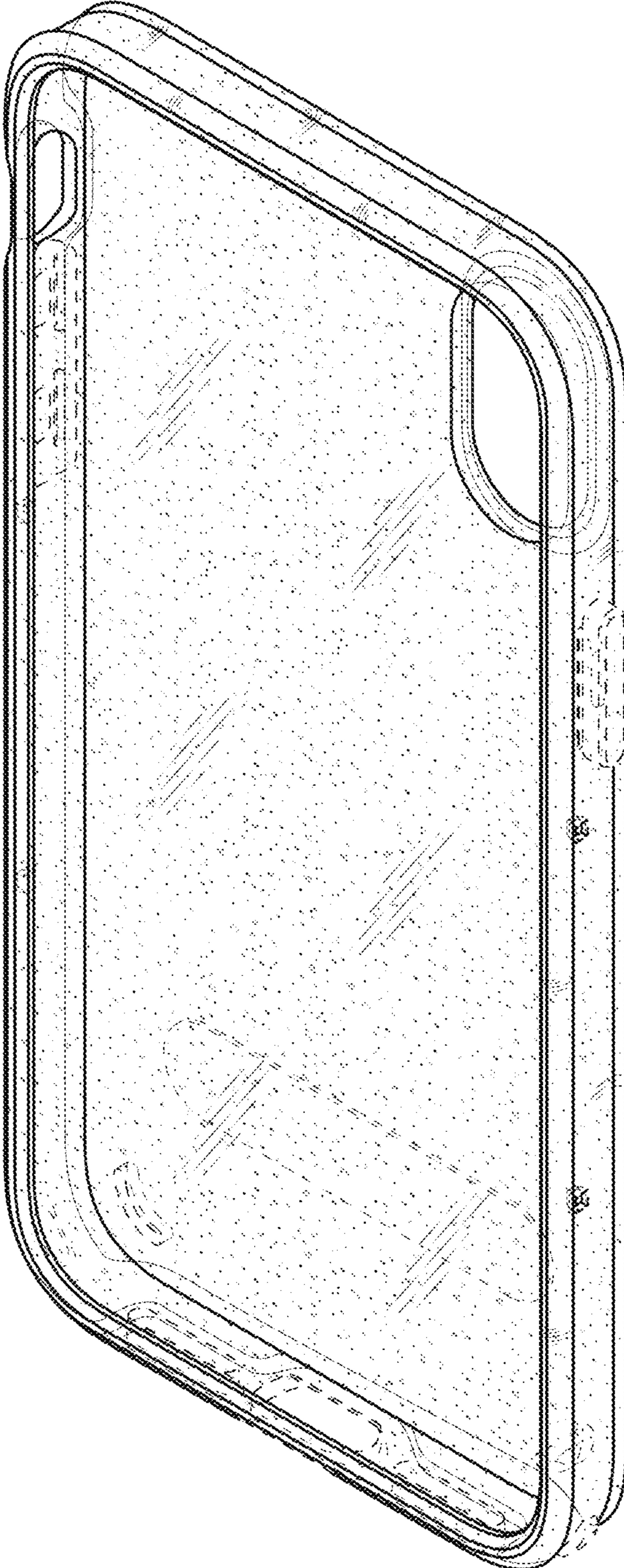

FIG. 11

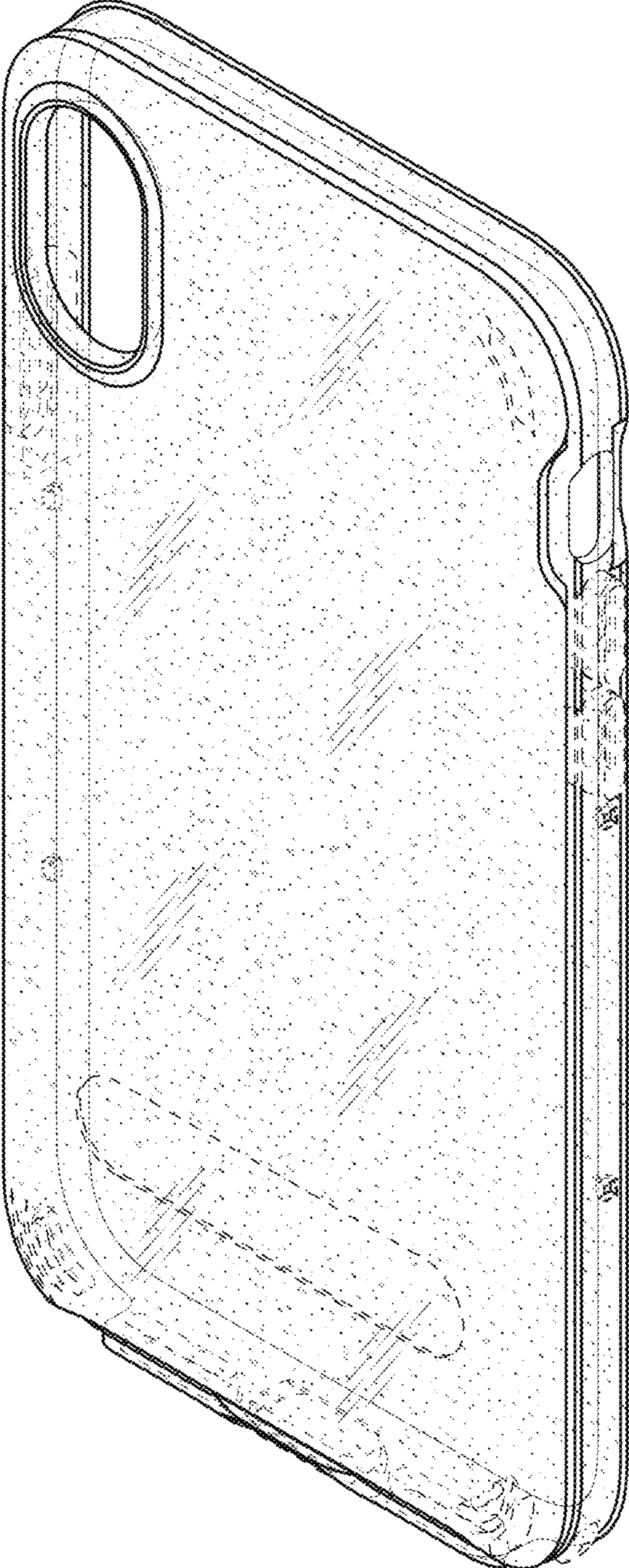

FIG. 12

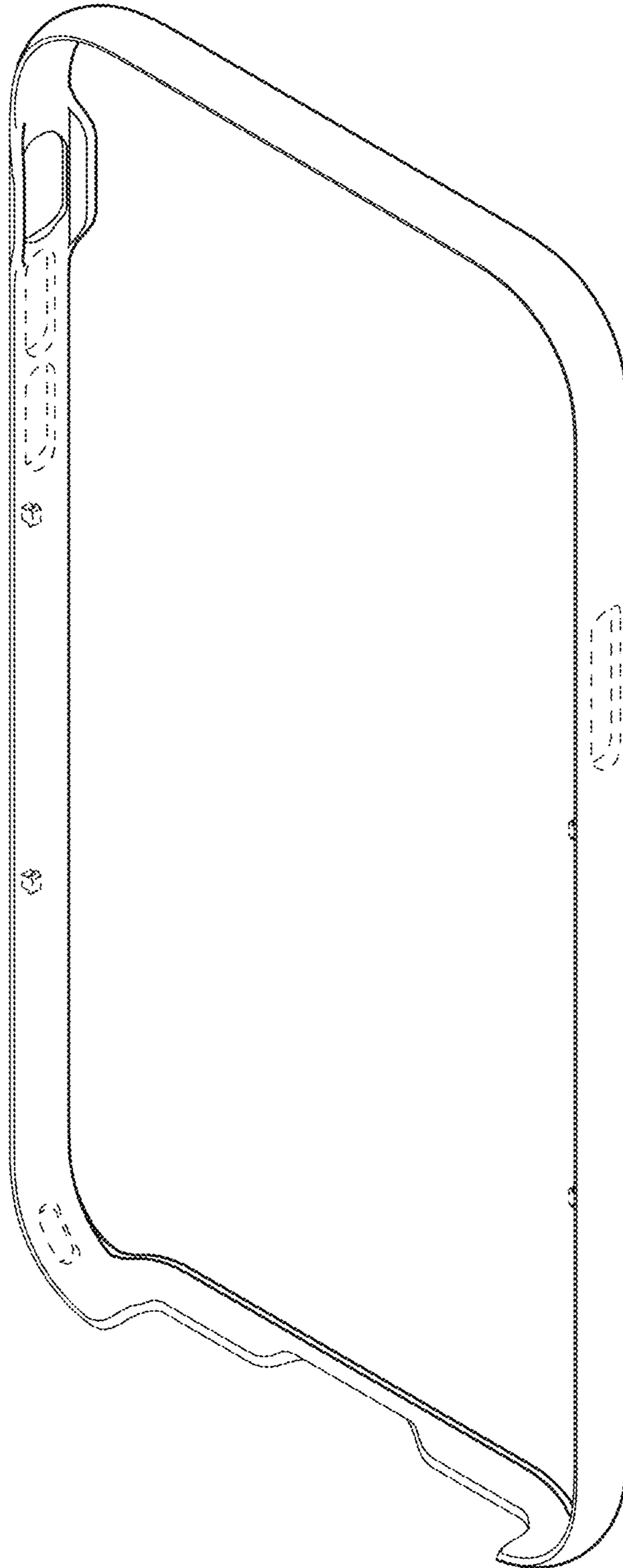

FIG. 13

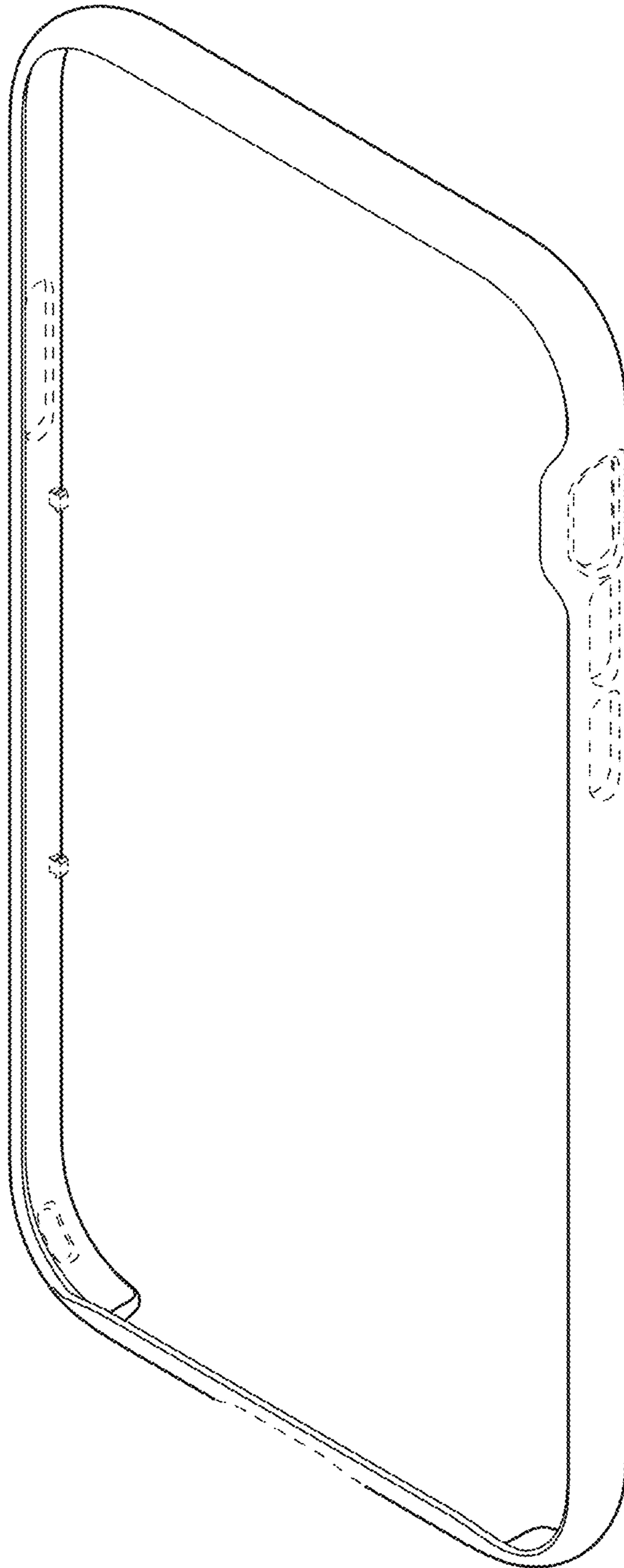

FIG. 14

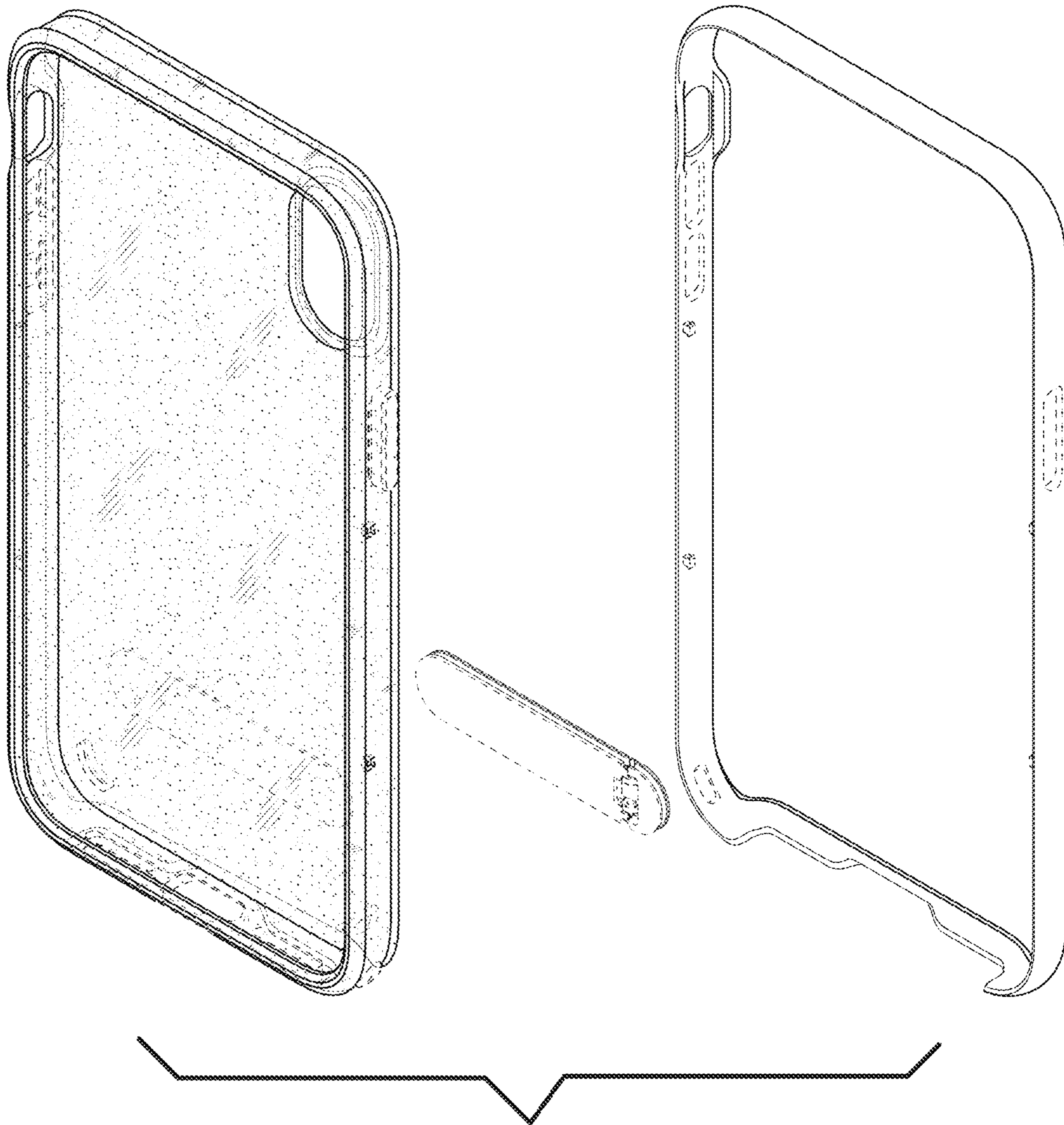

FIG. 15

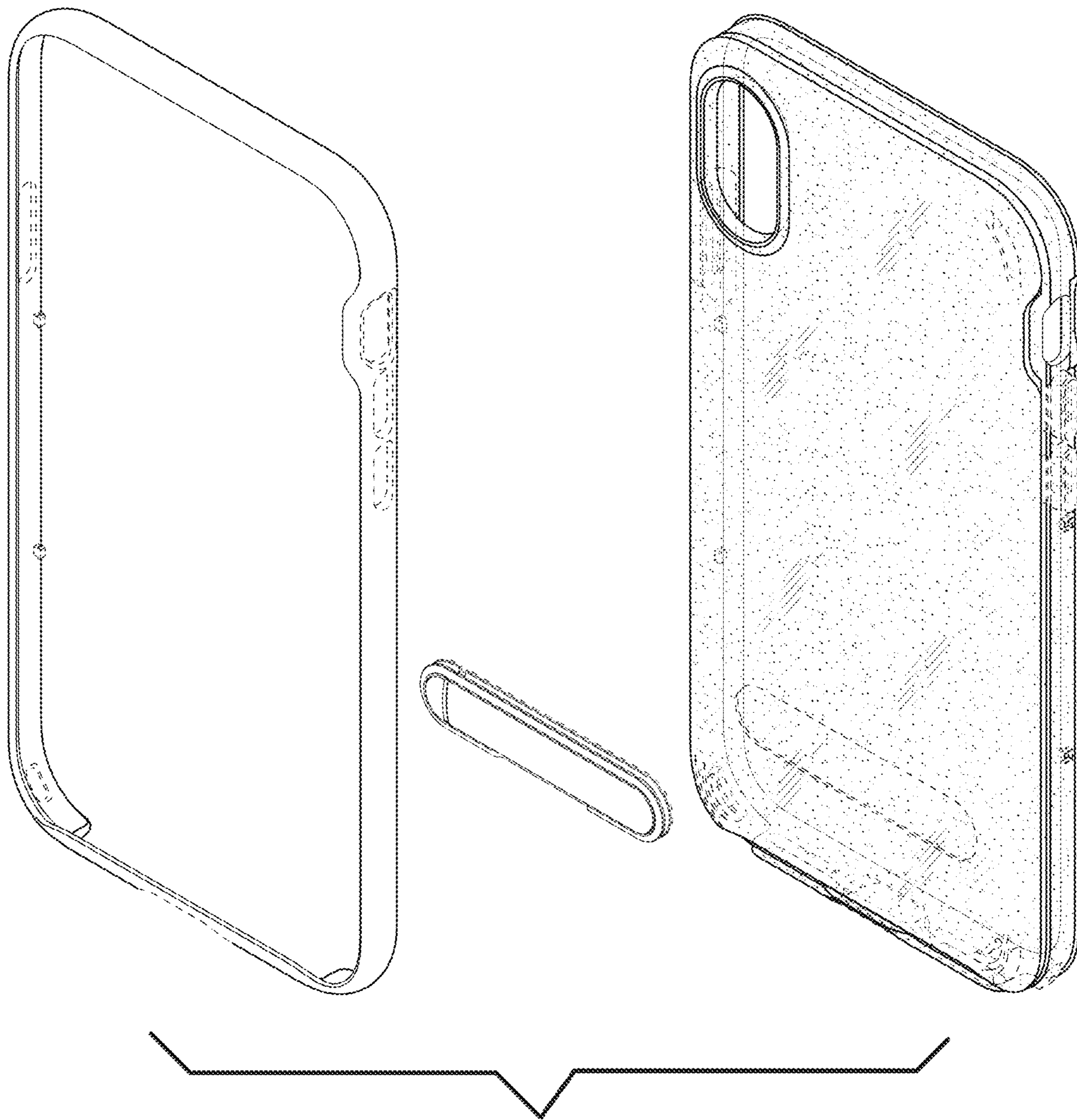

FIG. 16

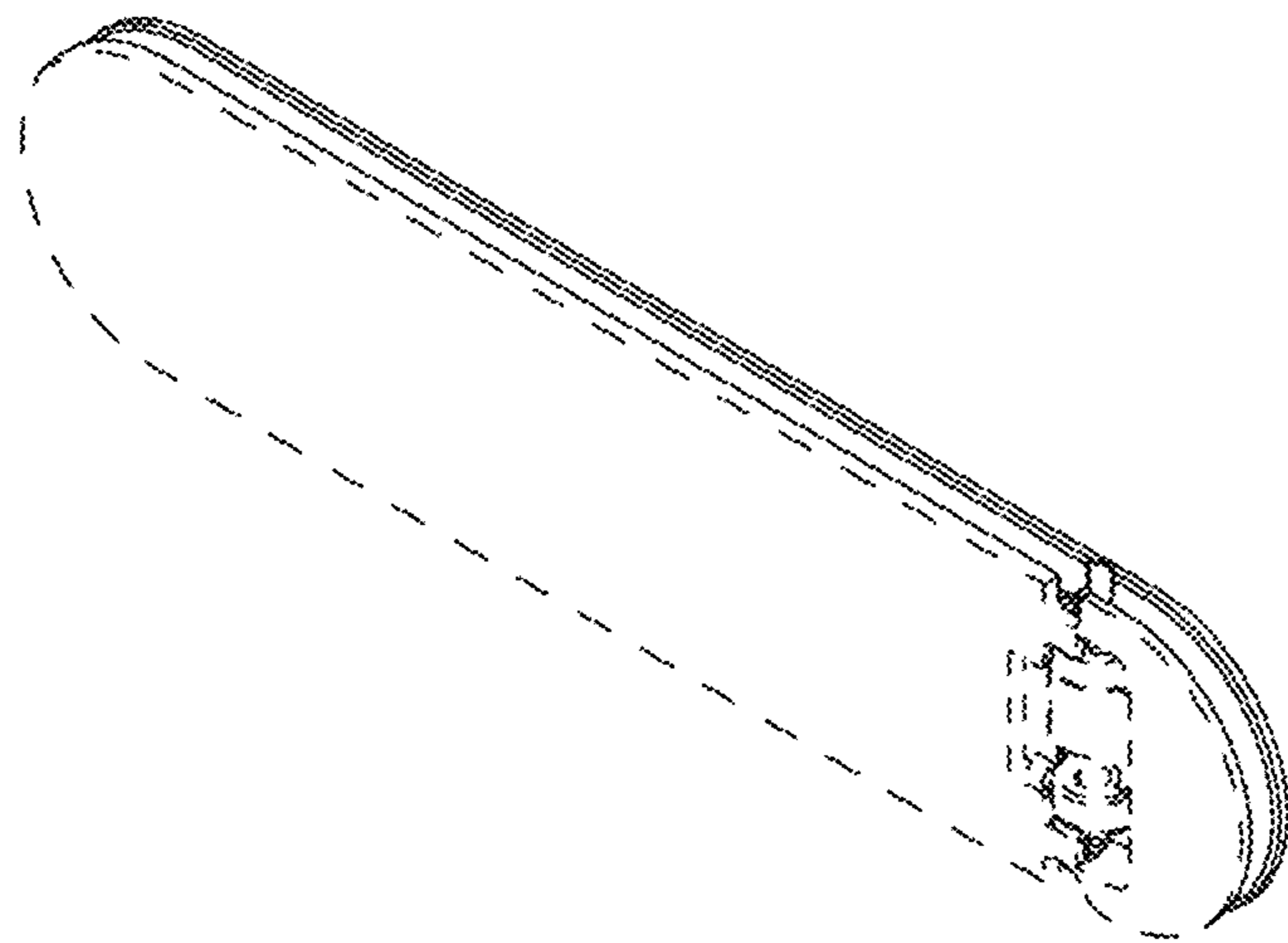

FIG. 17

