



US00D868659S

(12) **United States Design Patent**
Mikhailov

(10) **Patent No.:** **US D868,659 S**

(45) **Date of Patent:** **** Dec. 3, 2019**

(54) **OFF-ROAD VEHICLE SIDE PANEL**

(71) Applicant: **BOMBARDIER RECREATIONAL PRODUCTS INC.**, Valcourt (CA)

(72) Inventor: **Alexei Mikhailov**, Bromont (CA)

(73) Assignee: **BOMBARDIER RECREATIONAL PRODUCTS INC.**, Valcourt (CA)

(**) Term: **15 Years**

(21) Appl. No.: **29/640,671**

(22) Filed: **Mar. 16, 2018**

Related U.S. Application Data

(63) Continuation-in-part of application No. 29/618,356, filed on Sep. 20, 2017.

(51) **LOC (12) Cl.** **12-16**

(52) **U.S. Cl.**
USPC **D12/196**

(58) **Field of Classification Search**
USPC D12/86, 88, 90-92, 164, 184, 190, 196
(Continued)

(56) **References Cited**

U.S. PATENT DOCUMENTS

D286,760 S 11/1986 Ooba et al.
D312,989 S 12/1990 Murata et al.

(Continued)

FOREIGN PATENT DOCUMENTS

EM 003396324-1 10/2016

OTHER PUBLICATIONS

Bibliographic data of Brazilian Design No. 302012006313; retrieved from <https://www.tmdn.org/tmdsview-web/welcome> on Sep. 26, 2018.

Primary Examiner — Darlington Ly

(74) *Attorney, Agent, or Firm* — BCF LLP

(57) **CLAIM**

The ornamental design for an off-road vehicle side panel, as shown and described.

DESCRIPTION

FIG. 1 is a right side elevation view of an off-road vehicle side panel showing my new design in accordance to a first embodiment;

FIG. 2 is a front elevation view thereof;

FIG. 3 is a left side elevation view thereof;

FIG. 4 is a rear elevation view thereof;

FIG. 5 is a top plan view thereof;

FIG. 6 is a bottom plan view thereof;

FIG. 7 is a perspective view taken from a front, right side thereof;

FIG. 8 is a perspective view taken from a rear, right side thereof;

FIG. 9 is a perspective view taken from a front, right side thereof shown on a vehicle shown in dotted lines;

FIG. 10 is a left side elevation view of an off-road vehicle side panel showing my new design in accordance to a second embodiment;

FIG. 11 is a front elevation view thereof;

FIG. 12 is a right side elevation view thereof;

FIG. 13 is a rear elevation view thereof;

FIG. 14 is a top plan view thereof;

FIG. 15 is a bottom plan view thereof;

FIG. 16 is a perspective view taken from a front, left side thereof;

FIG. 17 is a perspective view taken from a rear, left side thereof; and,

FIG. 18 is a perspective view taken from a front, left side thereof shown on a vehicle shown in dotted lines.

The broken line showing portions of the off-road vehicle is provided for the purpose of illustrating environmental structure and forms no part of the claimed design.

1 Claim, 18 Drawing Sheets

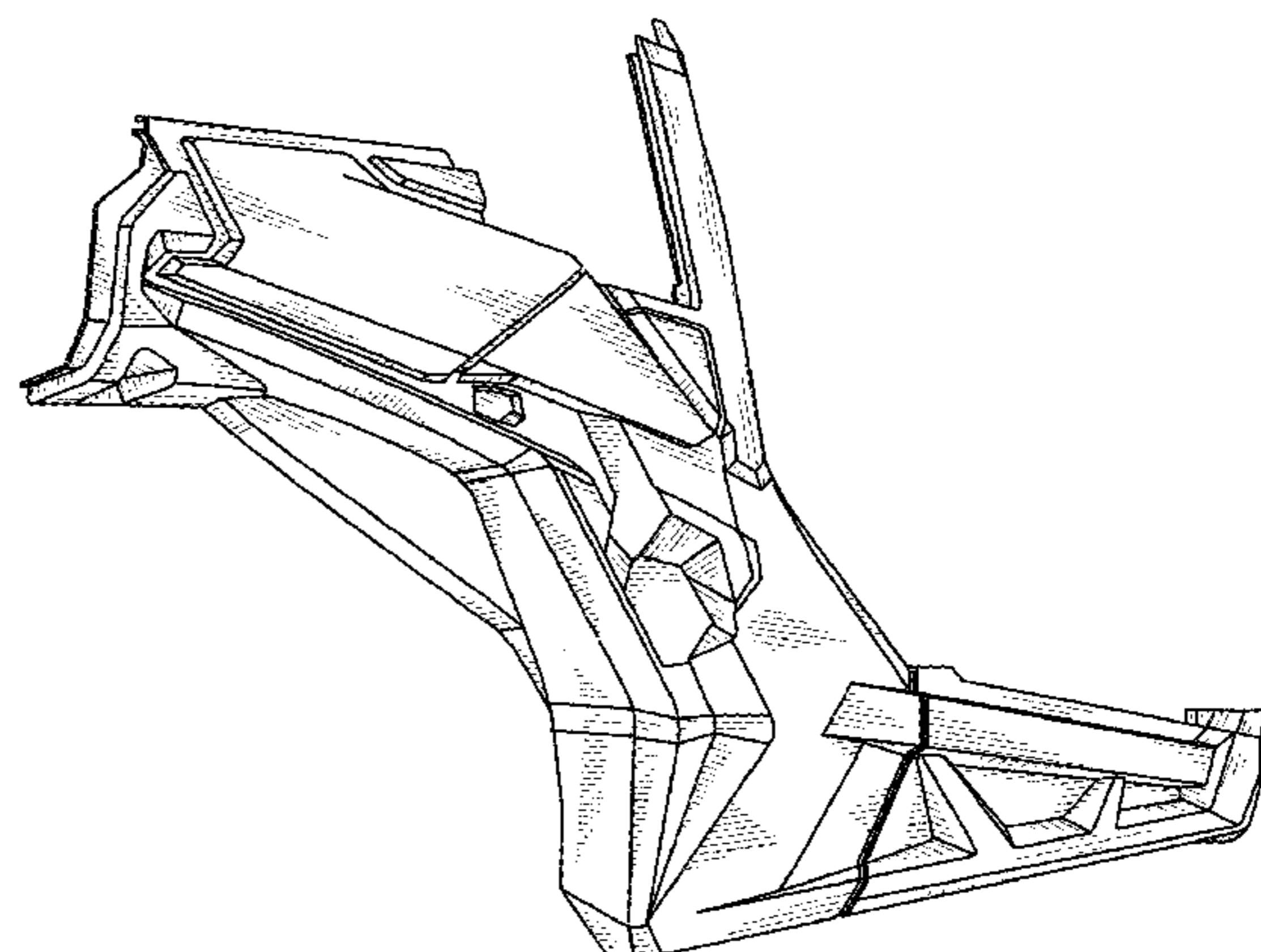
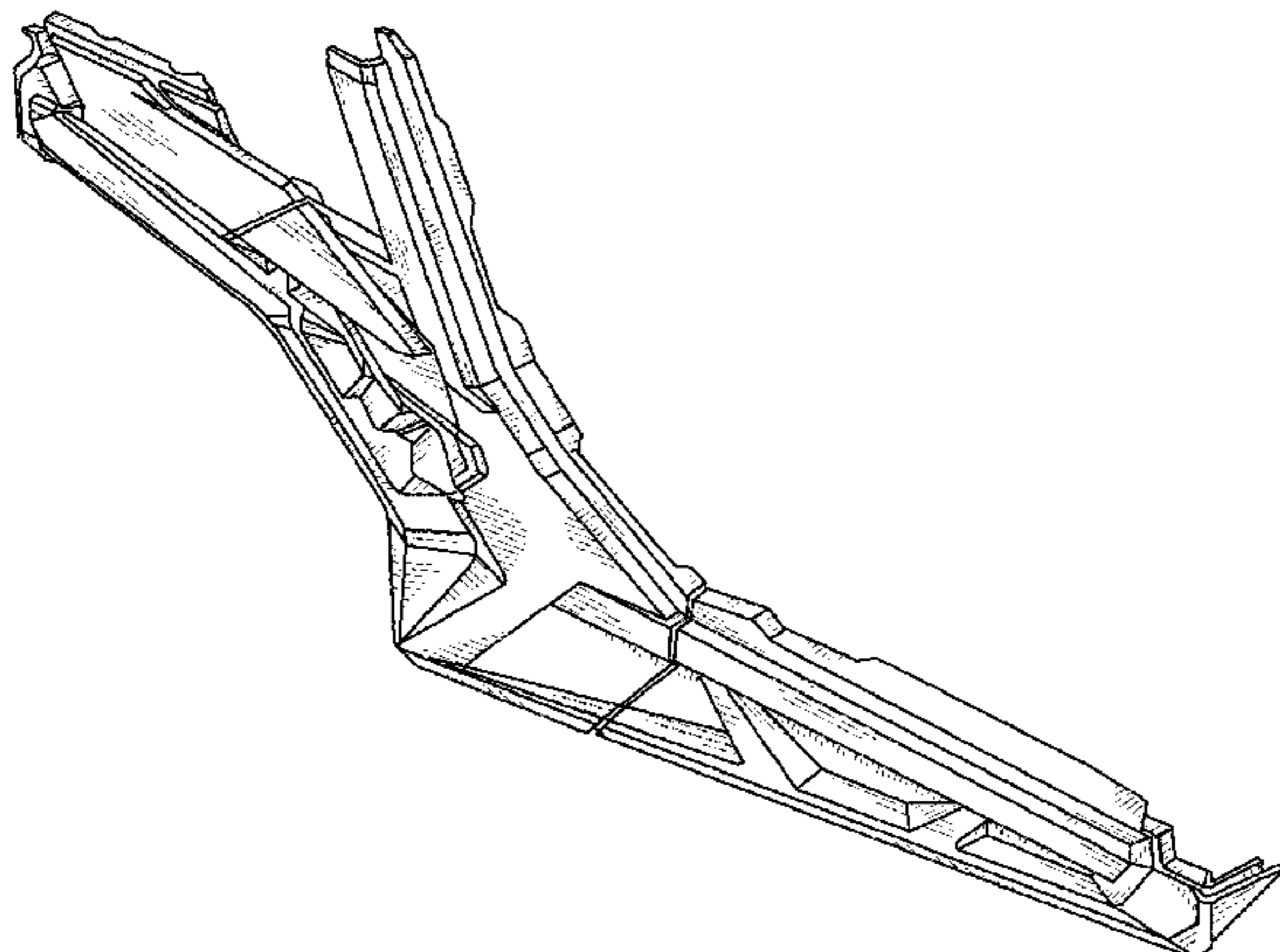

(58) **Field of Classification Search**

CPC B60J 5/0412; B60J 5/04; B62D 25/02;
B62D 25/04; B62D 25/16; B62D 25/184;
B62D 25/161; B62D 25/168

See application file for complete search history.

(56)

References Cited

U.S. PATENT DOCUMENTS

D327,237 S 6/1992 Miyamoto et al.
D500,707 S 1/2005 Lu
D503,658 S 4/2005 Lu
D549,133 S 8/2007 LePage
D555,036 S * 11/2007 Eck D12/87
D622,631 S 8/2010 Lai et al.
D631,395 S 1/2011 Tandrup et al.
D631,791 S * 2/2011 Sanschagrín D12/14
D633,006 S * 2/2011 Sanschagrín D12/14
D650,311 S 12/2011 Bracy

D660,746 S 5/2012 Bracy
D682,739 S 5/2013 Patterson et al.
D701,469 S 3/2014 Lai et al.
D703,102 S * 4/2014 Eck D12/87
D705,127 S 5/2014 Patterson et al.
D712,311 S 9/2014 Morgan et al.
D719,061 S * 12/2014 Tandrup D12/87
D737,724 S 9/2015 Schroeder et al.
D739,304 S 9/2015 Brown
9,327,587 B2 5/2016 Spindler et al.
D762,522 S * 8/2016 Kinoshita D12/87
D764,974 S * 8/2016 Mikhailov D12/14
D772,755 S * 11/2016 Tandrup D12/14
9,725,023 B2 * 8/2017 Miller B60P 1/04
9,776,481 B2 10/2017 Deckard et al.
D804,993 S * 12/2017 Eck D12/87
D805,009 S 12/2017 Eck et al.
D805,015 S * 12/2017 Eck D12/196
D835,545 S * 12/2018 Hanten D12/87
D852,674 S * 7/2019 Wilcox D12/87

* cited by examiner

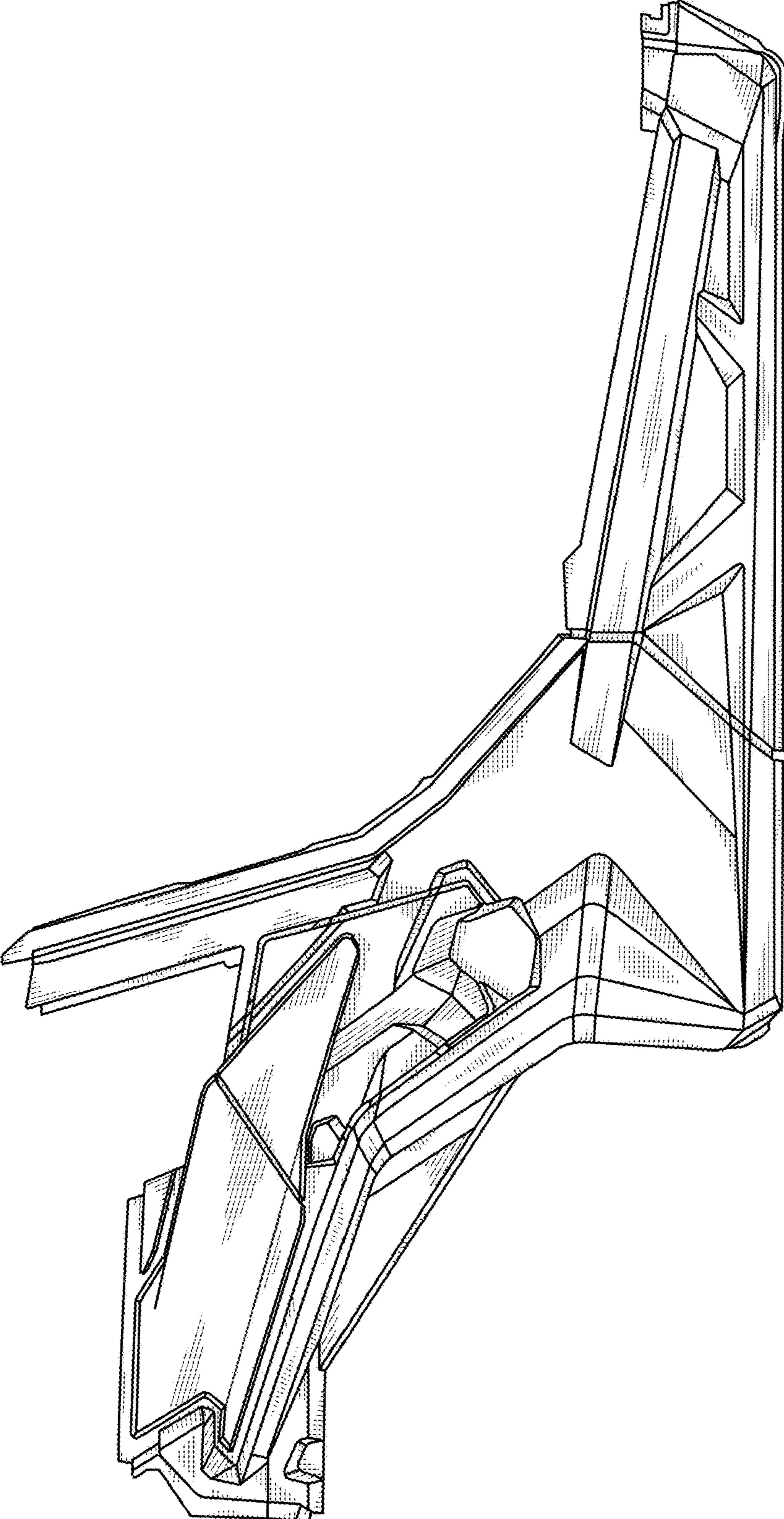

FIG.1

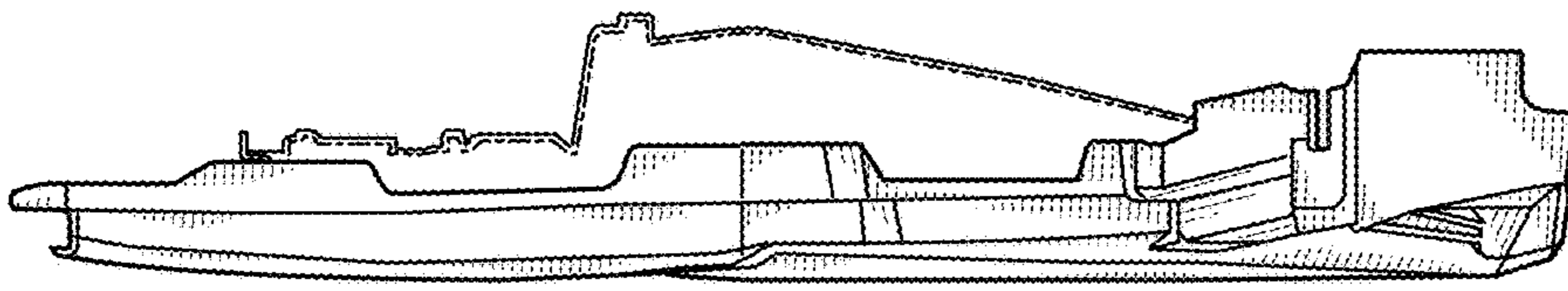

FIG. 2

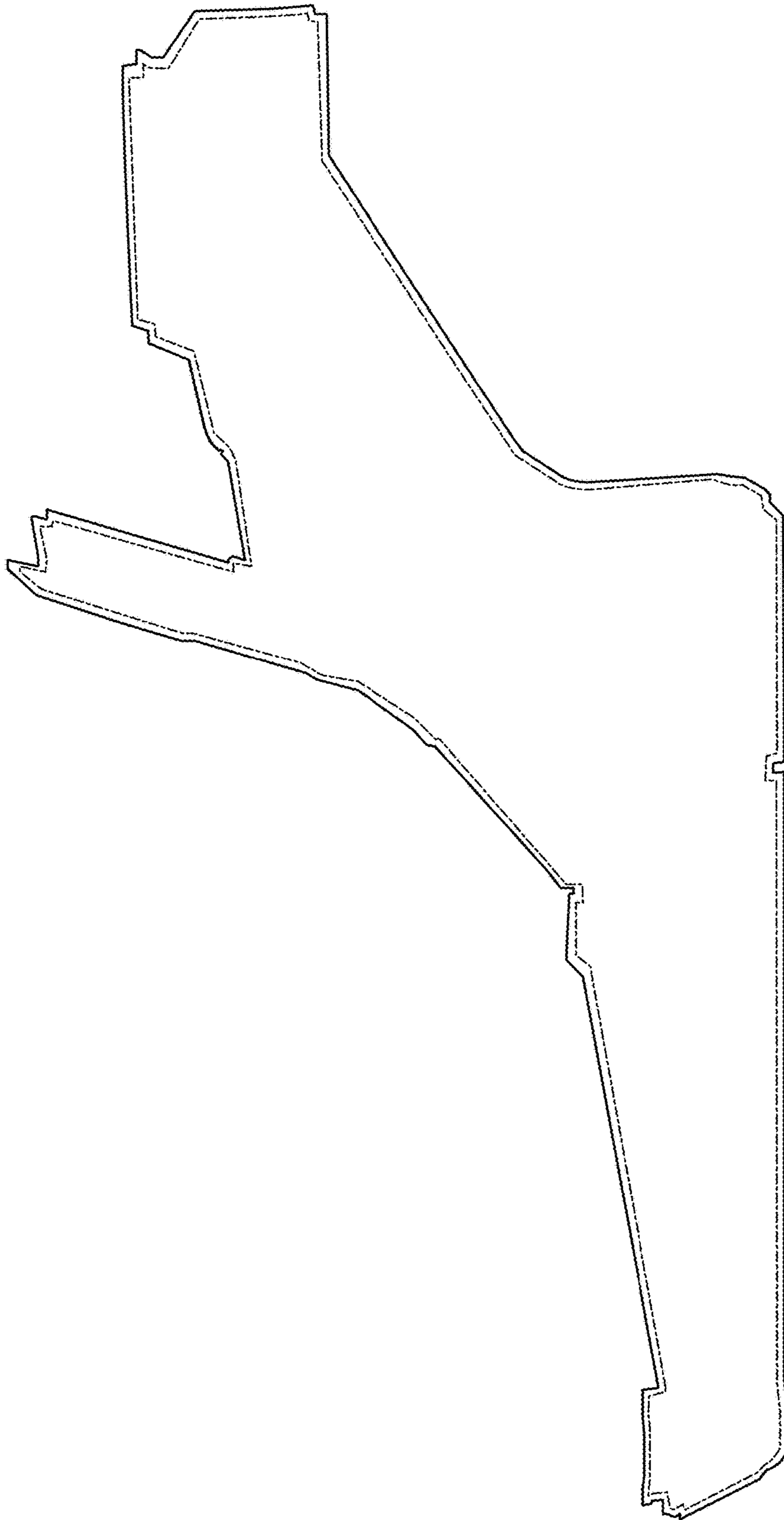

FIG. 3

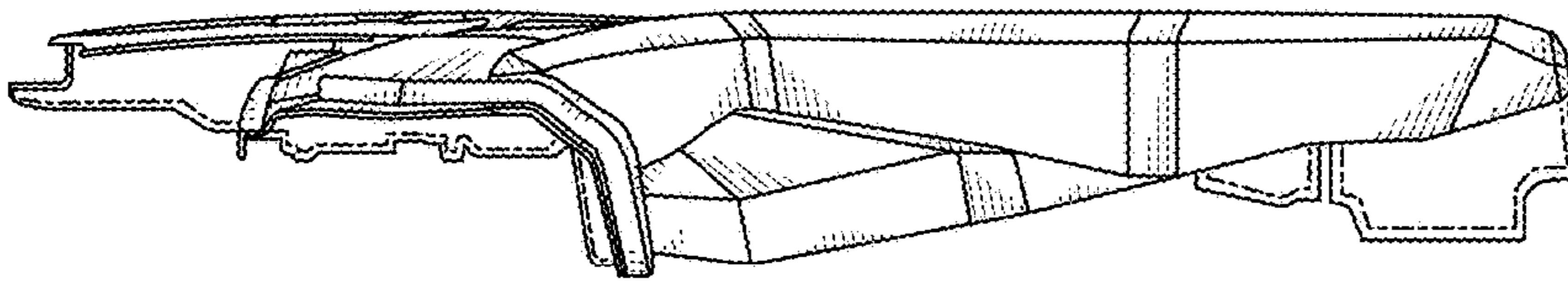

FIG.4

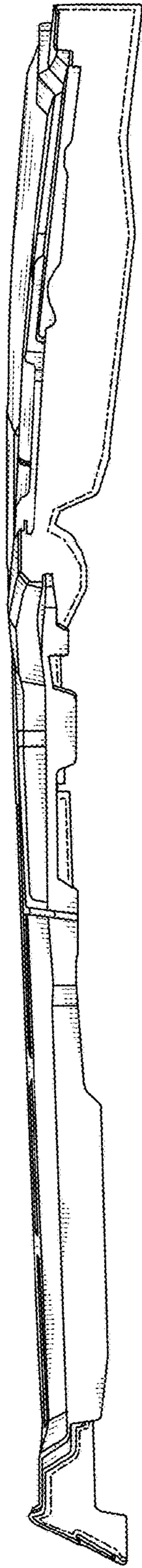

FIG.5

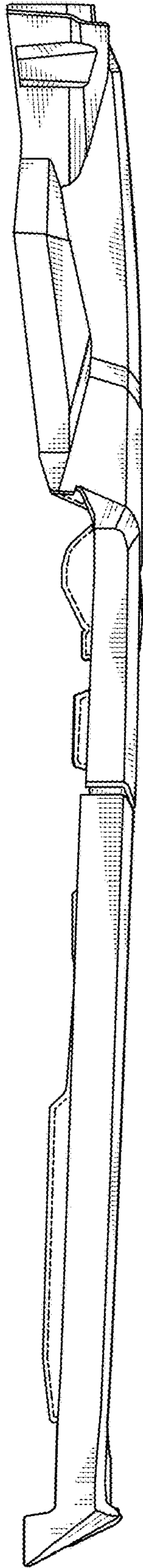

FIG. 6

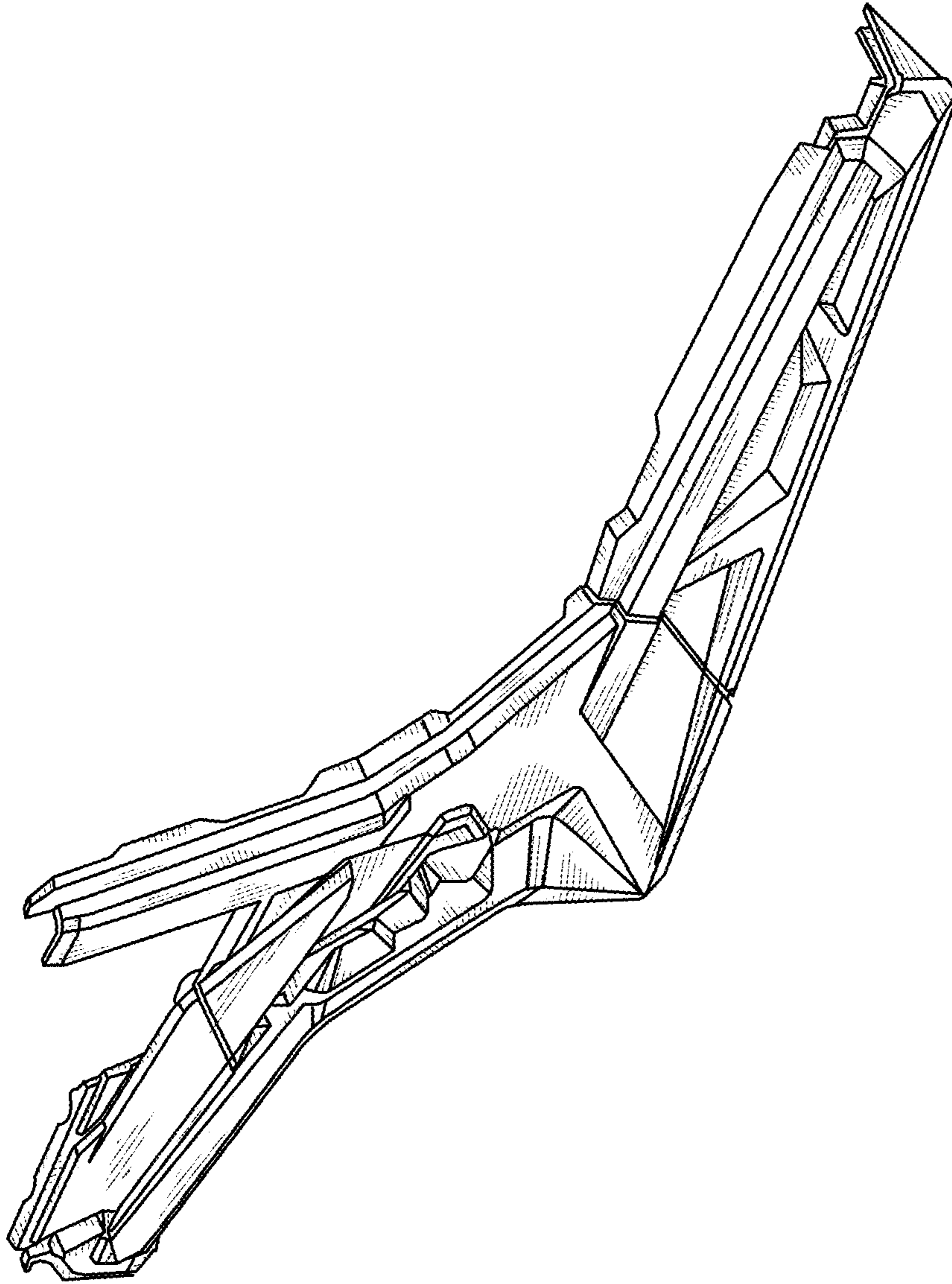

FIG. 7

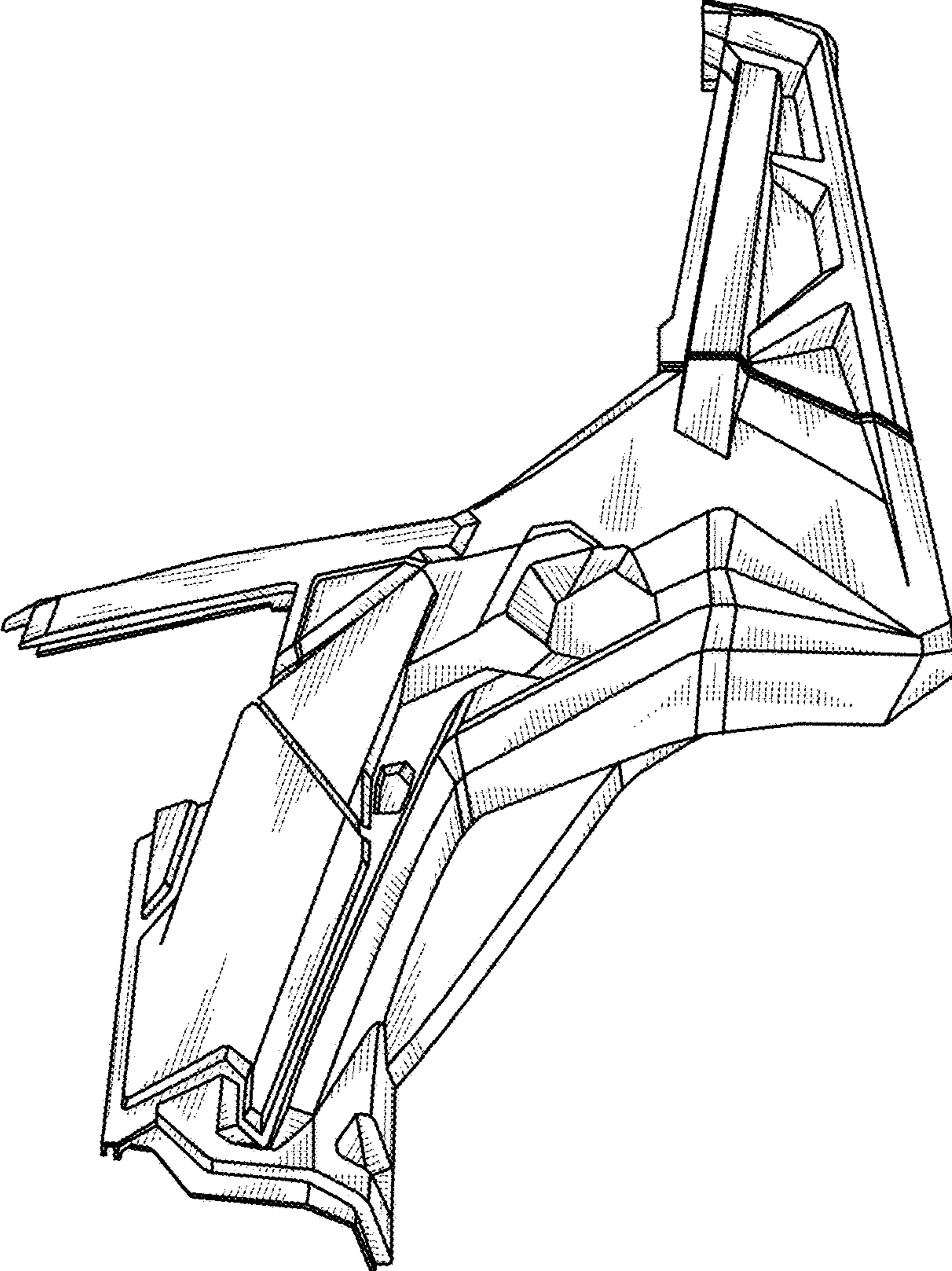

FIG. 8

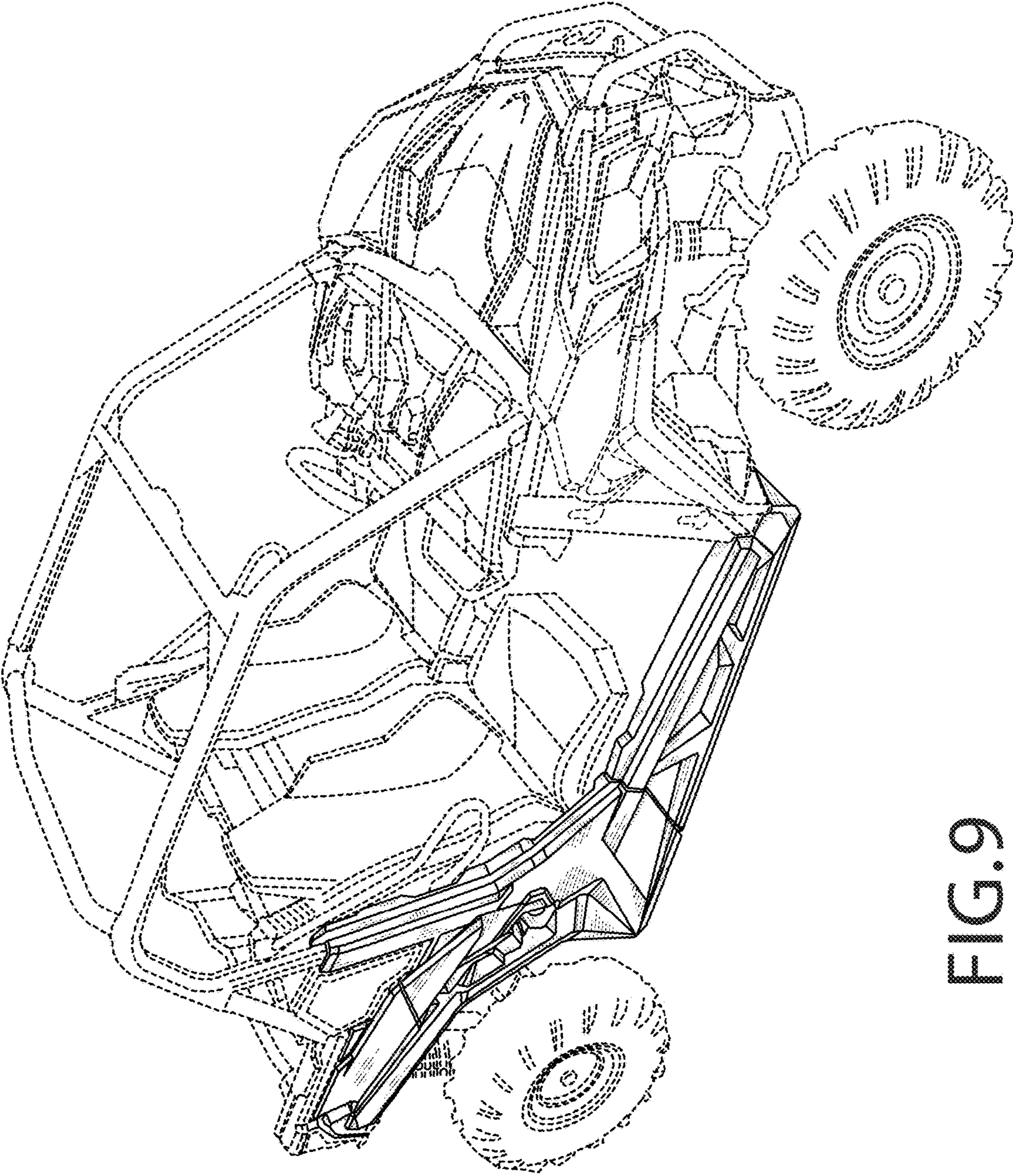

FIG. 9

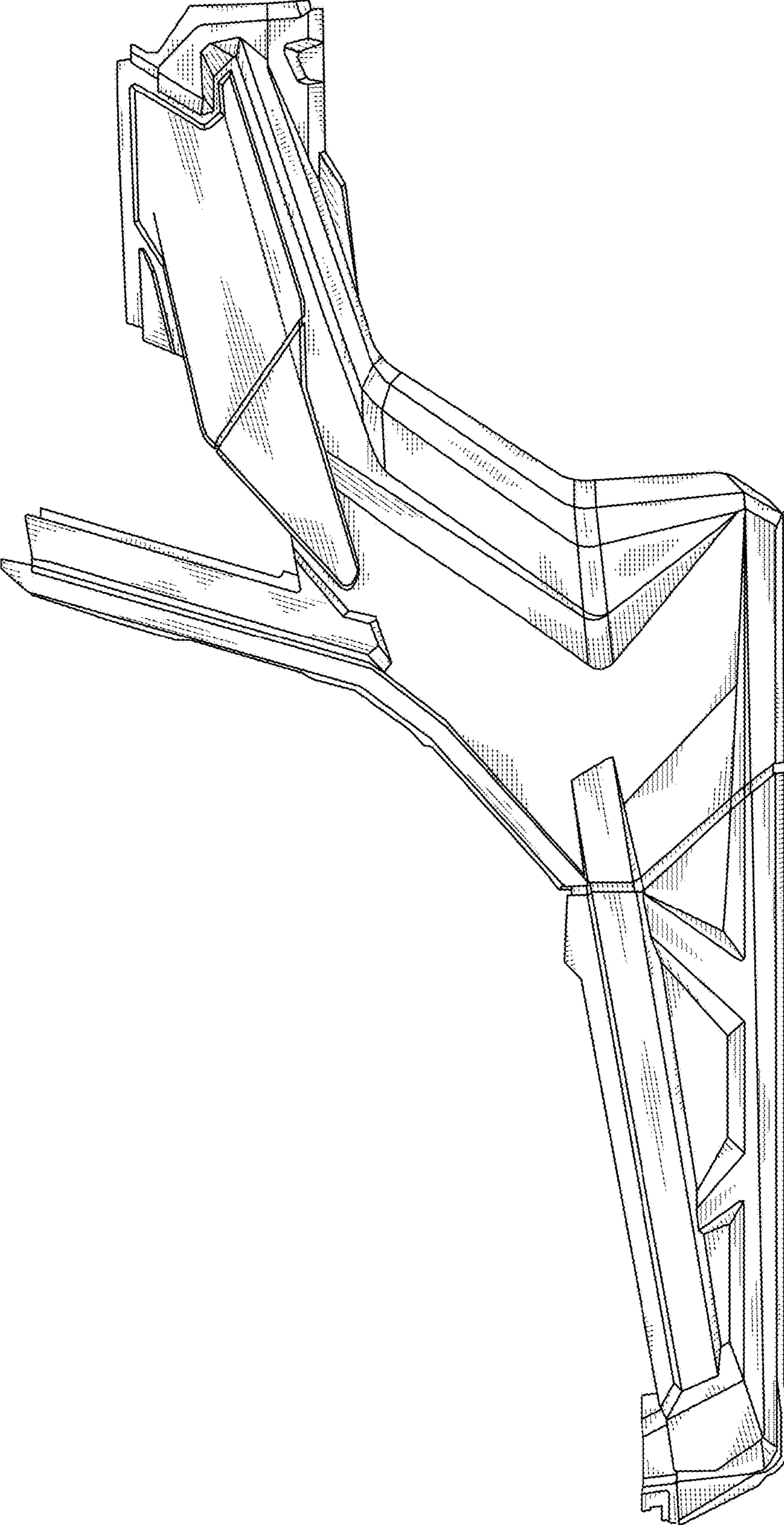

FIG.10

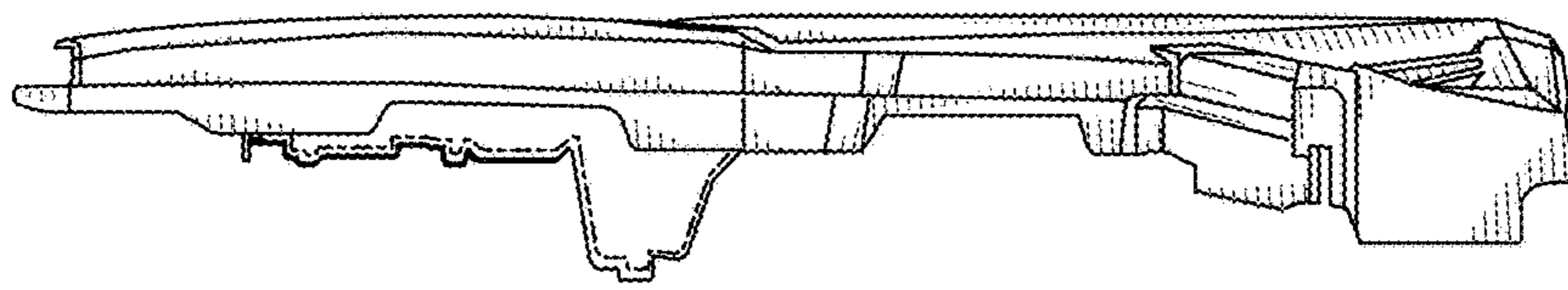

FIG.11

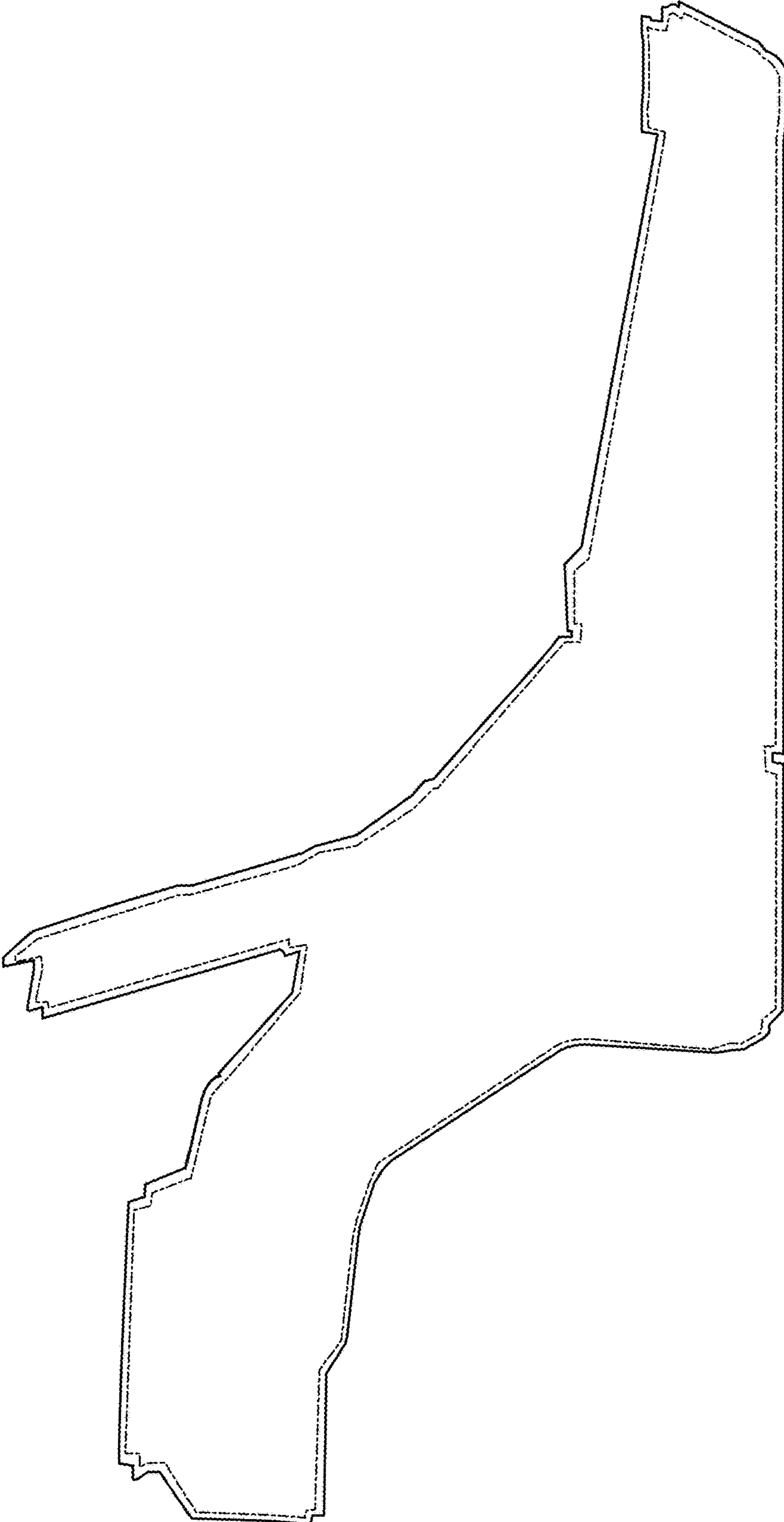

FIG.12

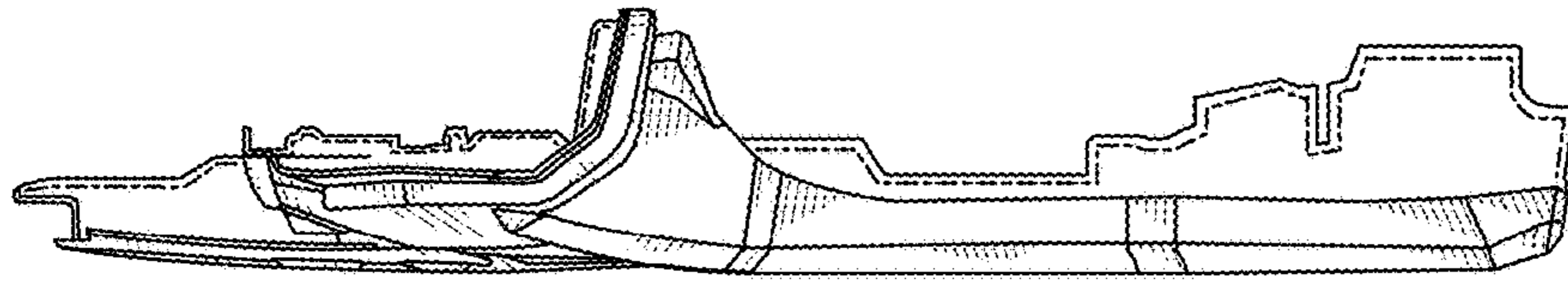

FIG.13

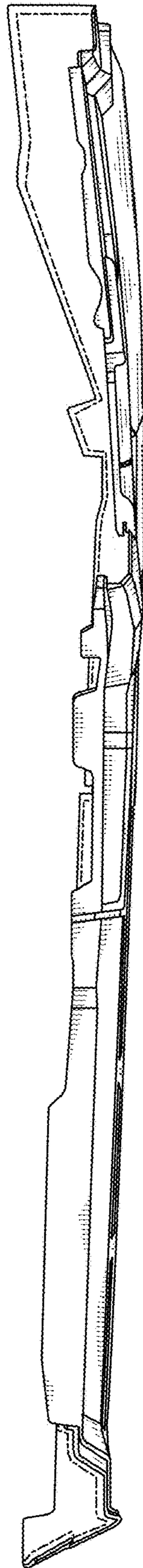

FIG.14

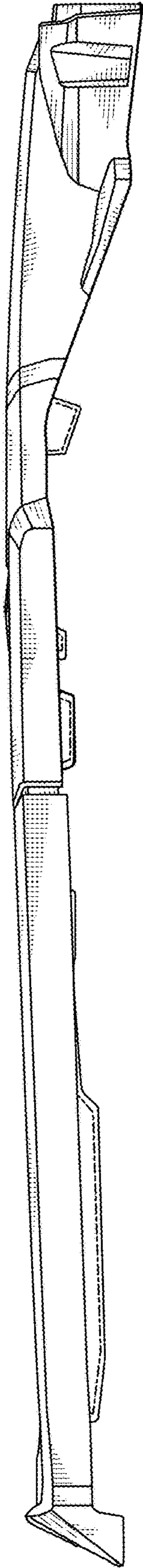

FIG.15

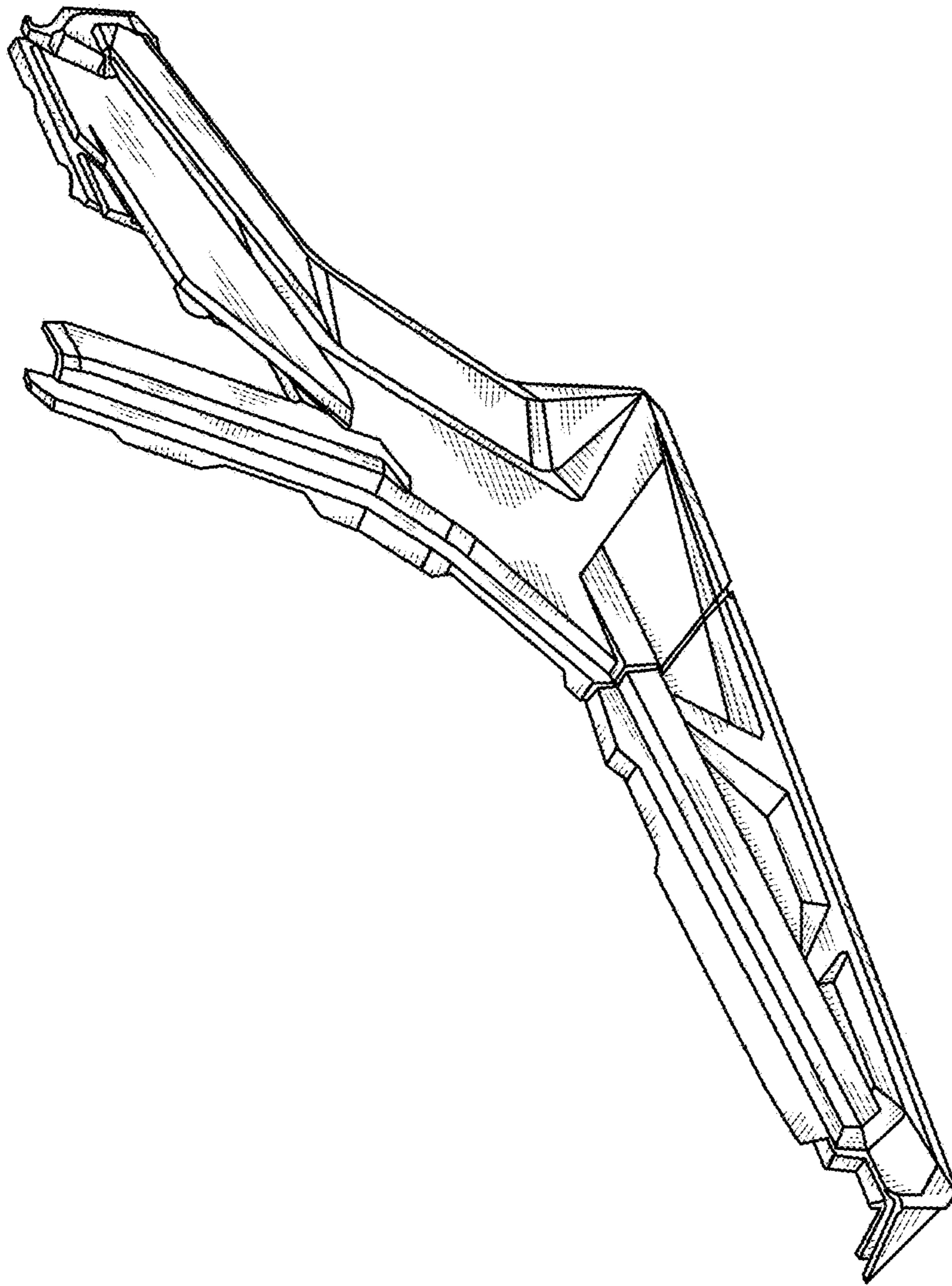

FIG.16

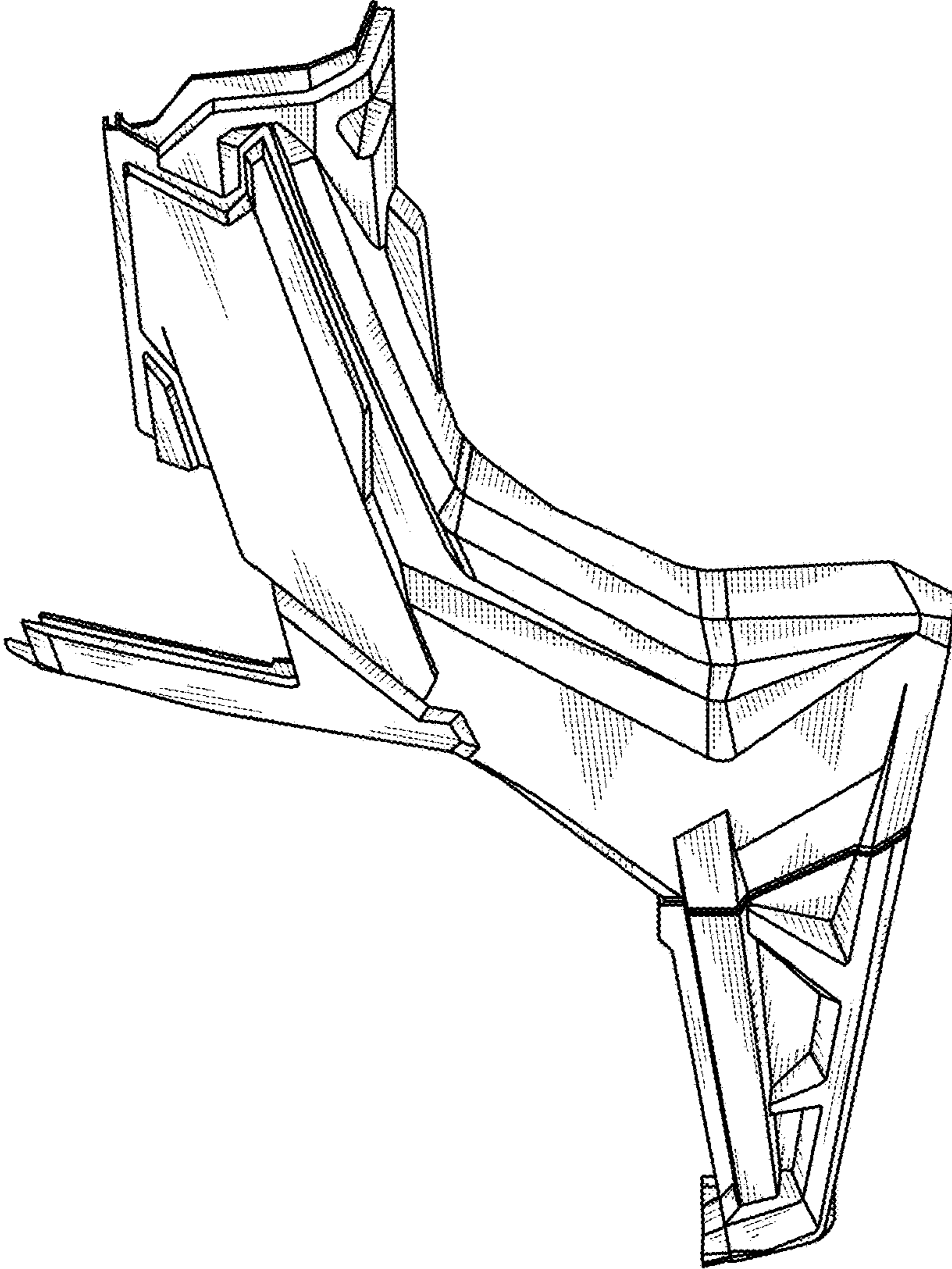

FIG.17

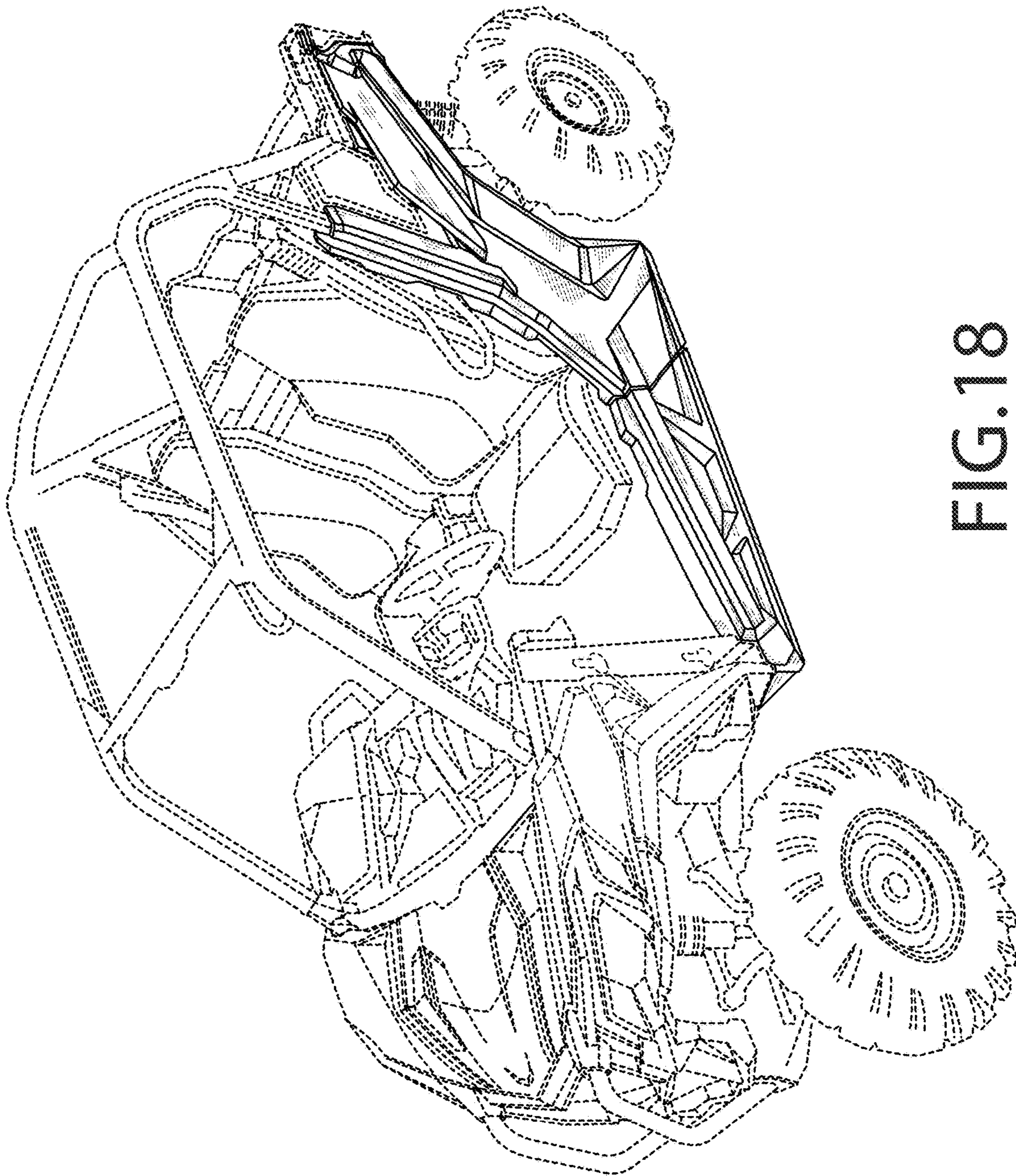

FIG. 18