



US00D868524S

(12) **United States Design Patent** (10) **Patent No.:** **US D868,524 S**
Miller et al. (45) **Date of Patent:** **** Dec. 3, 2019**

(54) **KETTLE**
(71) Applicant: **Spectrum Brands, Inc.**, Middleton, WI (US)
(72) Inventors: **John Aaron Miller**, Marshall, WI (US); **Gregory D. Roland**, Verona, WI (US)
(73) Assignee: **Spectrum Brands, Inc.**, Middleton, WI (US)
(**) Term: **15 Years**
(21) Appl. No.: **29/632,866**
(22) Filed: **Jan. 10, 2018**
(51) **LOC (12) Cl.** **07-01**
(52) **U.S. Cl.**
USPC **D7/317**; D7/318; D7/316
(58) **Field of Classification Search**
USPC D7/316-319, 312, 300, 309, 399, 397; D23/207, 209
CPC A47J 41/0005; A47J 31/20; A47J 31/50; A47J 31/44
See application file for complete search history.

D788,511 S * 6/2017 Powell D7/318
D796,247 S * 9/2017 Bazzicalupo D7/317
D811,148 S * 2/2018 Harrod D7/318
D818,756 S * 5/2018 Averty D7/318
2018/0303278 A1* 10/2018 Sachtleben A47J 31/4457

OTHER PUBLICATIONS

Myhome; "Delonghi Scultura Kettle zinc white"; Publication date unknown but prior to filing date of present application; Date Accessed: Jan. 30, 2018; URL: <http://my-homegroup.com/product/delonghi-scultura-kettle-zinc-white/?doing_wp_cron=1517333436.9252939224243164062500>.
Myhome; "Sunbeam 1.7l Ribbed Glass Kettle Black and clear"; Publication date unknown but prior to filing date of present application; Date Accessed: Jan. 30, 2018; URL: <<http://my-homegroup.com/product/sunbeam-1-7l-ribbed-glass-kettle-black-clear/>>.

(Continued)

Primary Examiner — Marianne N Pandozzi
(74) *Attorney, Agent, or Firm* — Banner & Witcoff, Ltd.

(57) **CLAIM**

The ornamental design for a kettle, as shown and described.

DESCRIPTION

FIG. 1 is a front perspective view of a kettle showing our new design;
FIG. 2 is a right side view thereof;
FIG. 3 is a left side view thereof;
FIG. 4 is a front view thereof;
FIG. 5 is a rear view thereof;
FIG. 6 is a top view thereof; and,
FIG. 7 is a bottom view thereof.
The broken line showing of the remainder of the kettle is for environmental purposes only and forms no part of the claimed design. The unshaded region within the spout feature represents an opening in the kettle and forms no part of the claimed design.

1 Claim, 7 Drawing Sheets

(56) **References Cited**

U.S. PATENT DOCUMENTS

D210,307 S * 2/1968 Branscum D7/313
7,118,050 B1 * 10/2006 Chen B05B 9/0861
239/328
D630,882 S * 1/2011 Cohen D7/317
D677,104 S * 3/2013 De'Longhi D7/318
D690,150 S * 9/2013 Cahen D7/309
D692,715 S * 11/2013 Tsui D7/312
D714,581 S * 10/2014 Shao D7/312
D726,485 S * 4/2015 Mullen D7/317
D726,486 S * 4/2015 Averty D7/312
D727,675 S * 4/2015 Garvey D7/319
D752,911 S * 4/2016 Bazzicalupo D7/317

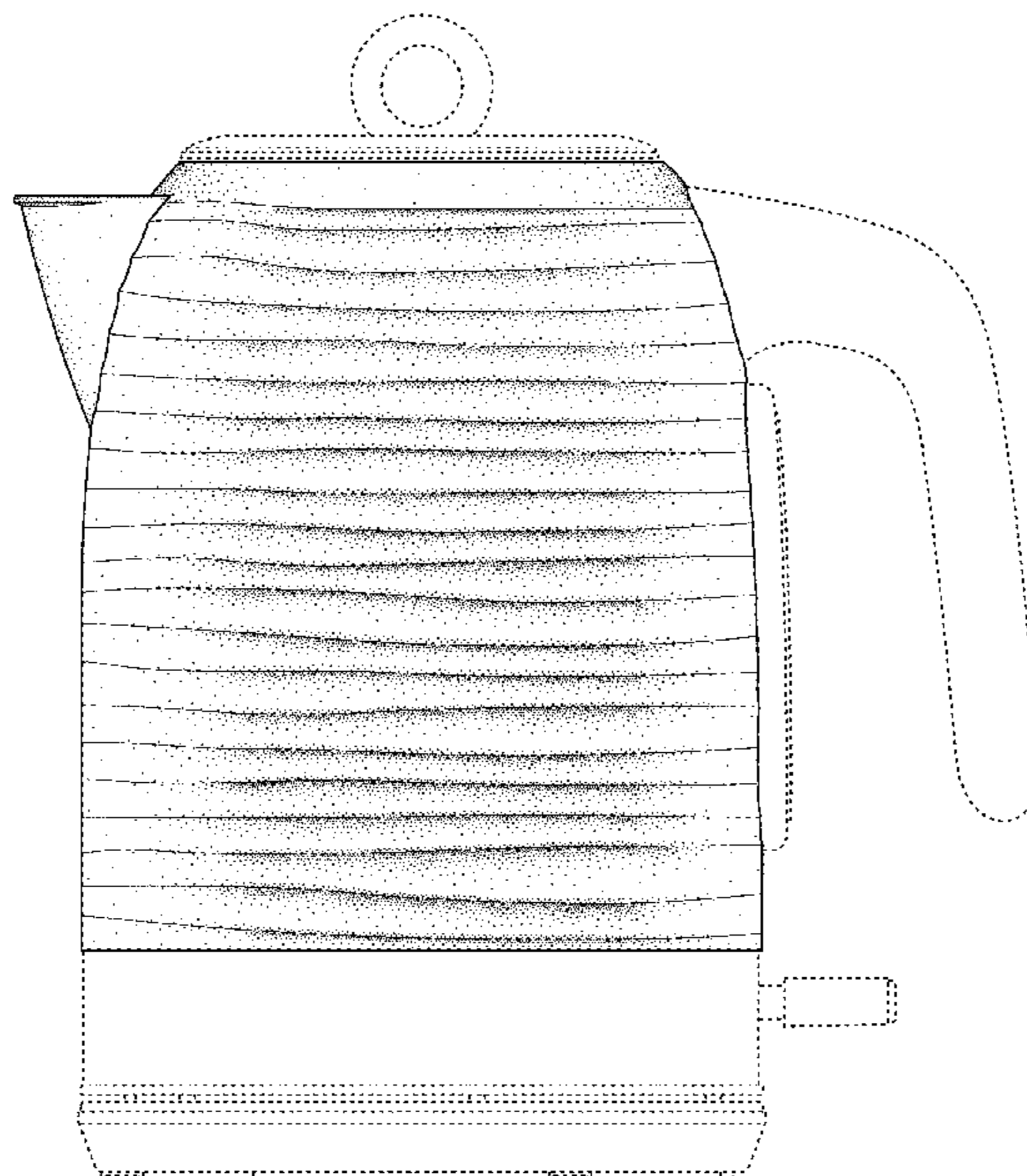

(56)

References Cited

OTHER PUBLICATIONS

Amazon; “Tower Kitchen Appliance Set—Black Ribbed Linear 1.7L Kettle and Black Ribbed 4-Slice Linear Toaster”; Publication date unknown but prior to filing date of present application; Date Accessed: Jan. 30, 2018; URL: <<https://www.amazon.co.uk/Tower-Kitchen-Appliance-Set-4-Slice/dp/B01N3PHO51>>.

Amazon; “Visicook Team Beehive Ribbed Glass Jug Kettle”; Publication date unknown but prior to filing date of present application; Date Accessed: Jan. 30, 2018; URL: <https://www.amazon.co.uk/Visicook-Beehive-Ribbed-Glass-Kettle/dp/B01N5ID8MZ/ref=sr_1_1?s=kitchen&ie=UTF8&qid=1517263114&sr=1-1&keywords=ribbed+kettle>.

Amazon; “EGL Stainless Steel Glass Jug Kettle”; Publication date unknown but prior to filing date of present application; Date Accessed: Jan. 30, 2018; URL: <https://www.amazon.co.uk/EGL-Stainless-Steel-Glass-Kettle/dp/B01AMRFNOI/ref=sr_1_6?s=kitchen&ie=UTF8&qid=1517263114&sr=1-6&keywords=ribbed+kettle>.

* cited by examiner

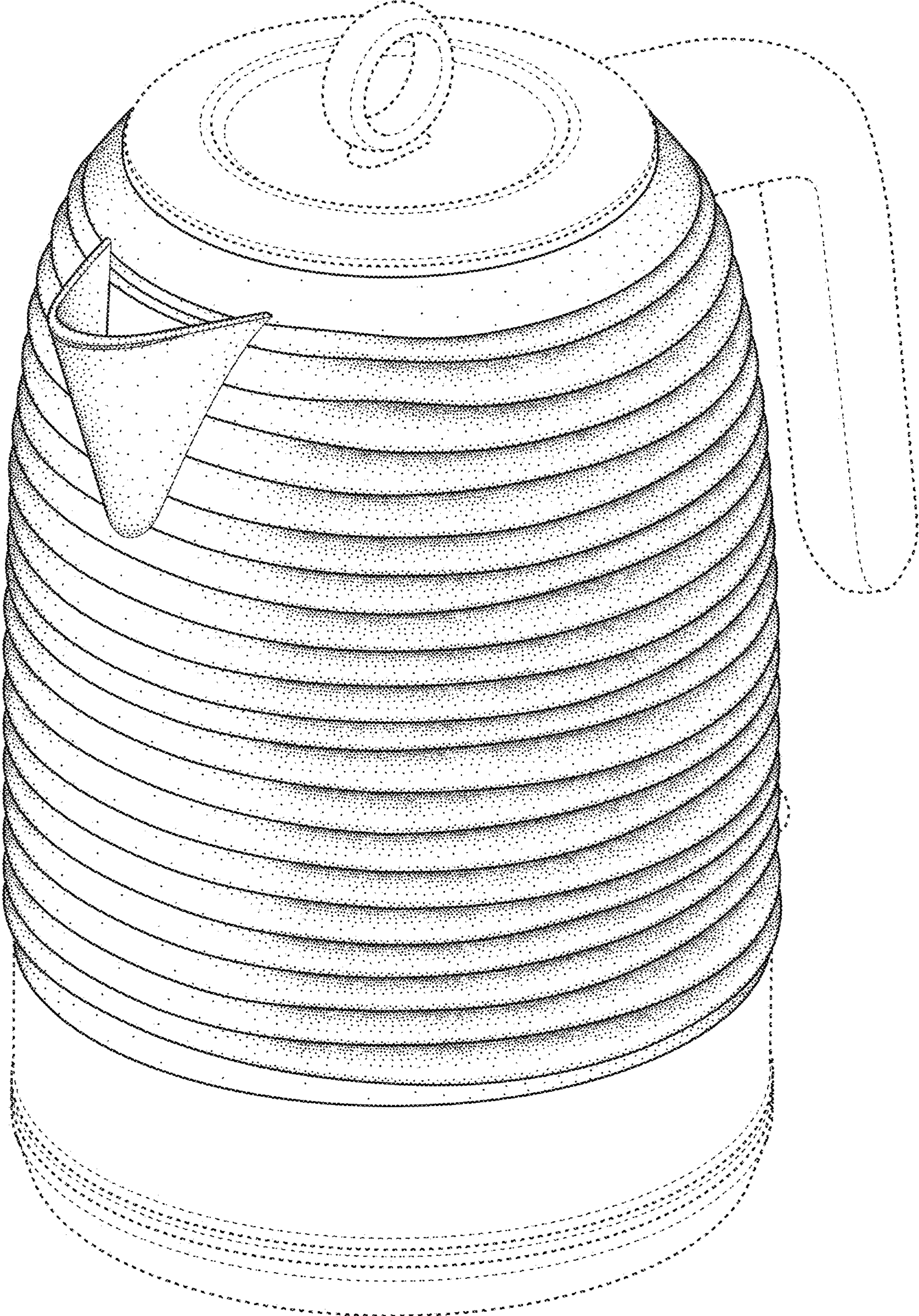

FIG. 1

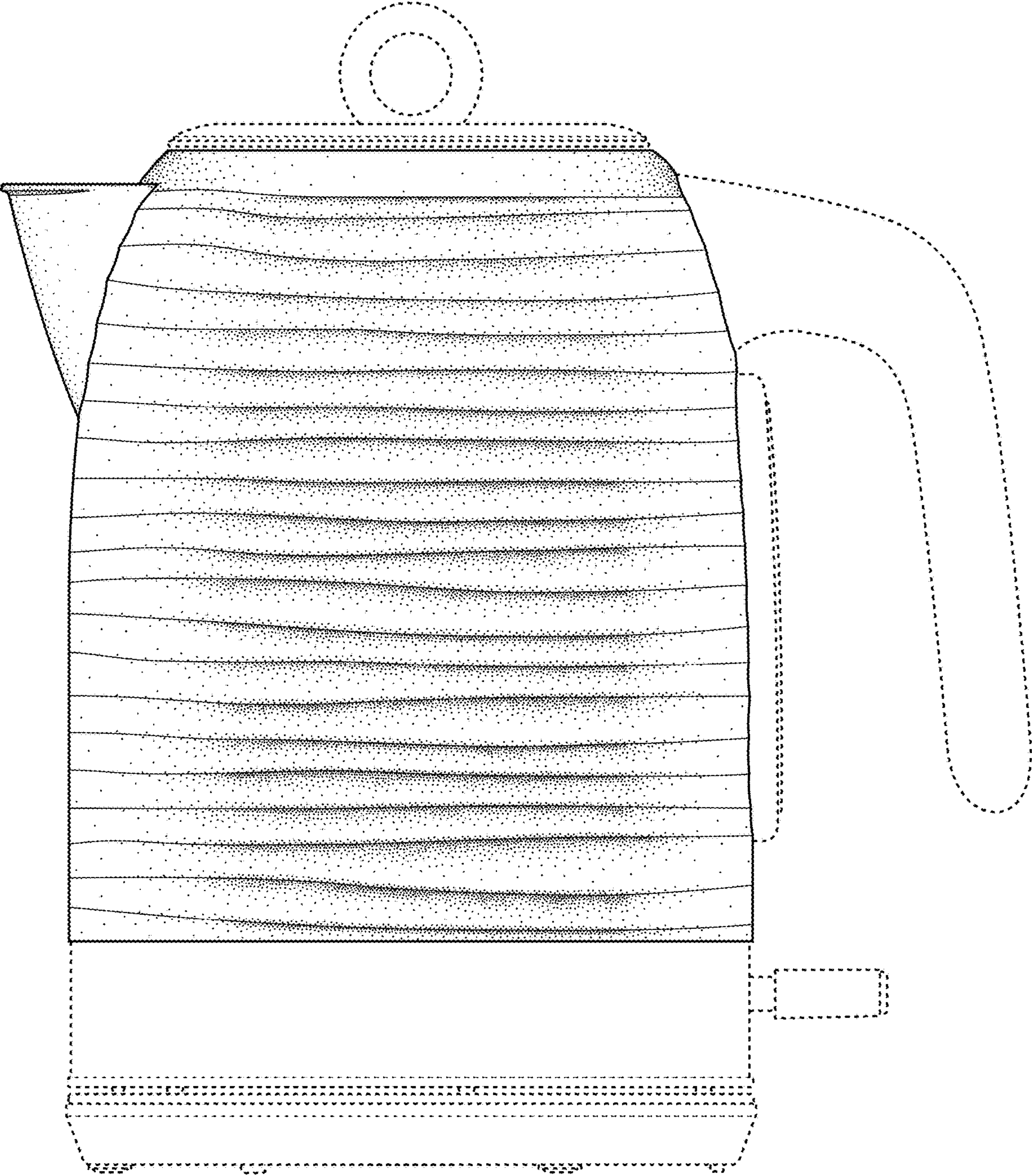

FIG. 2

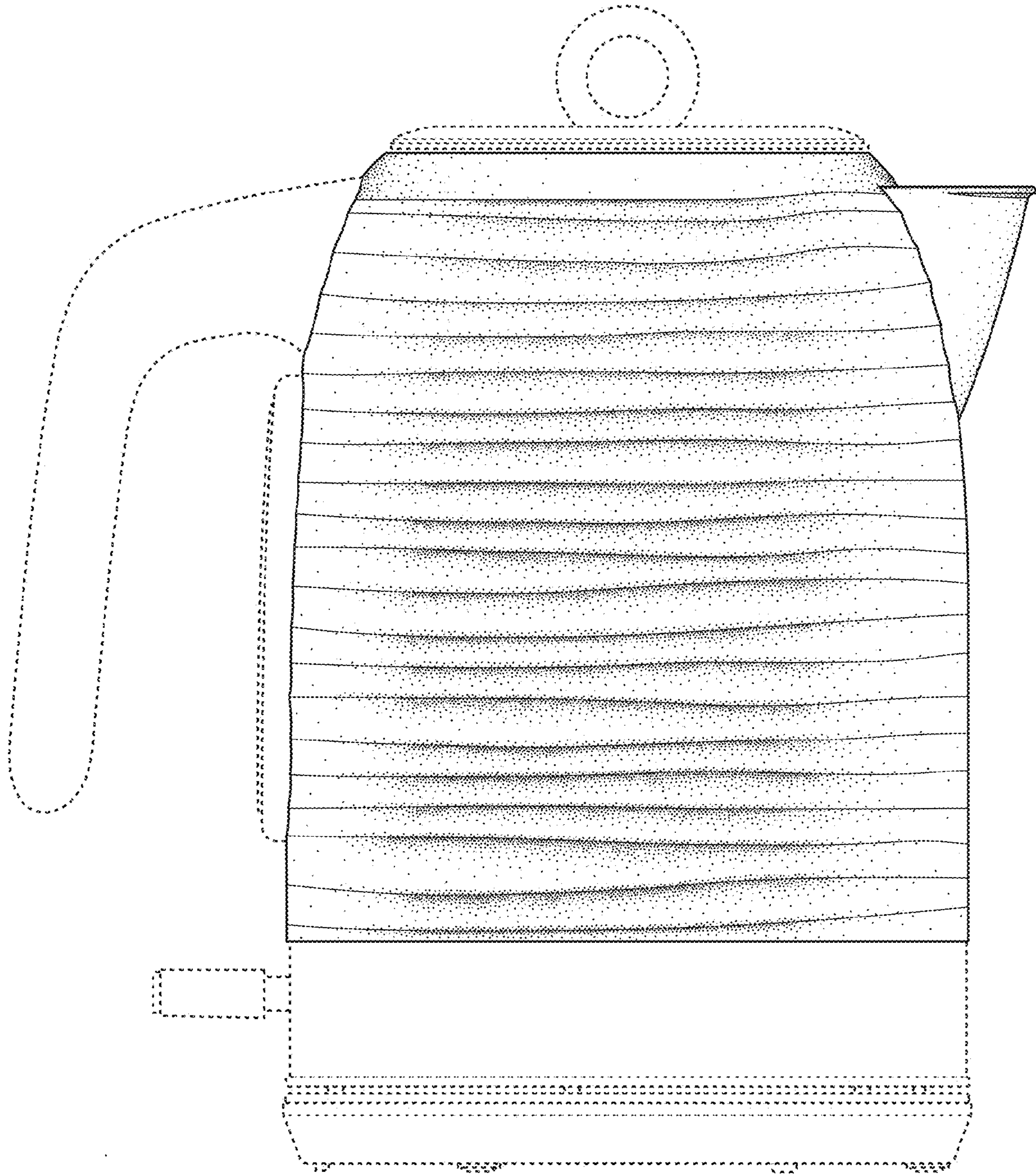

FIG. 3

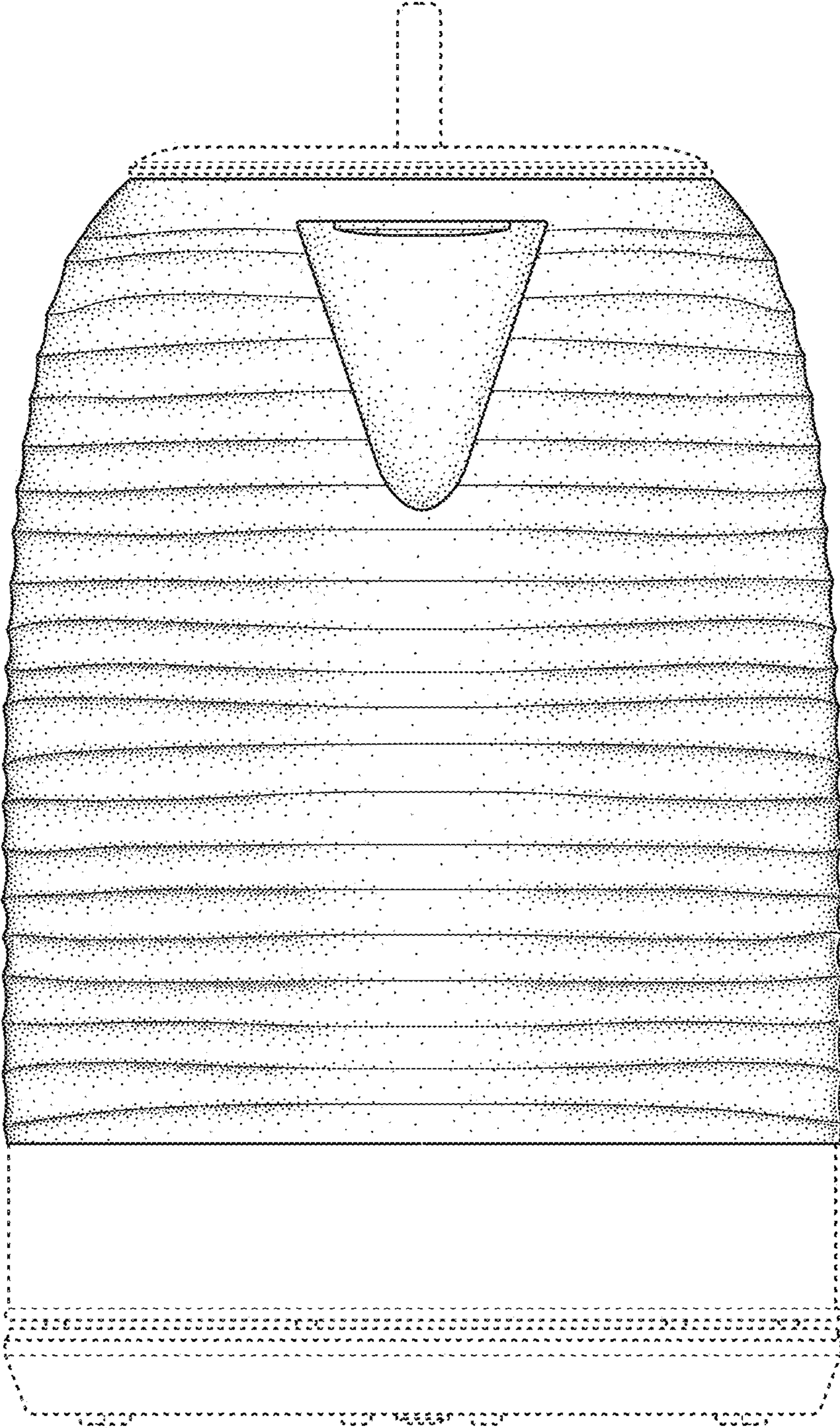

FIG. 4

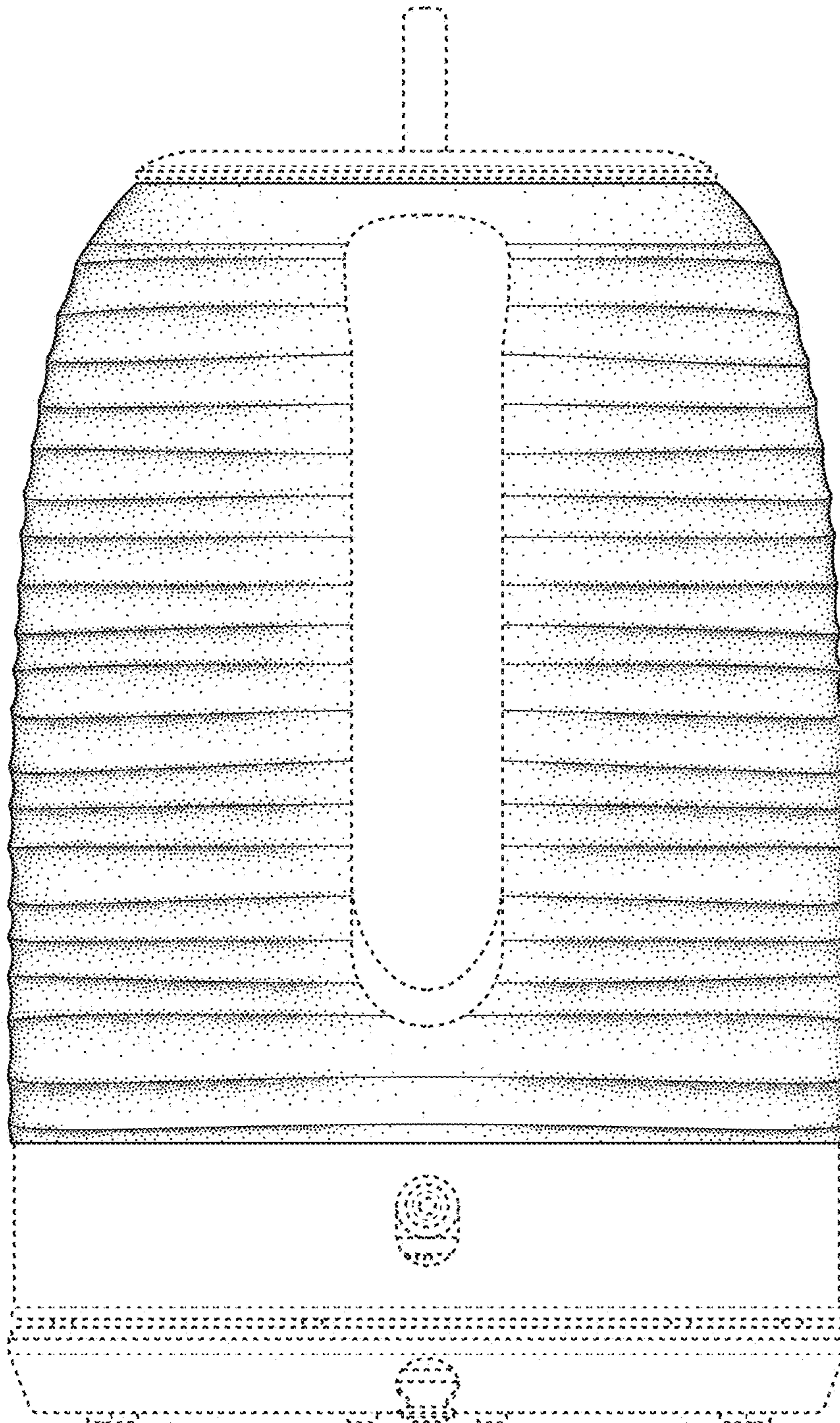

FIG. 5

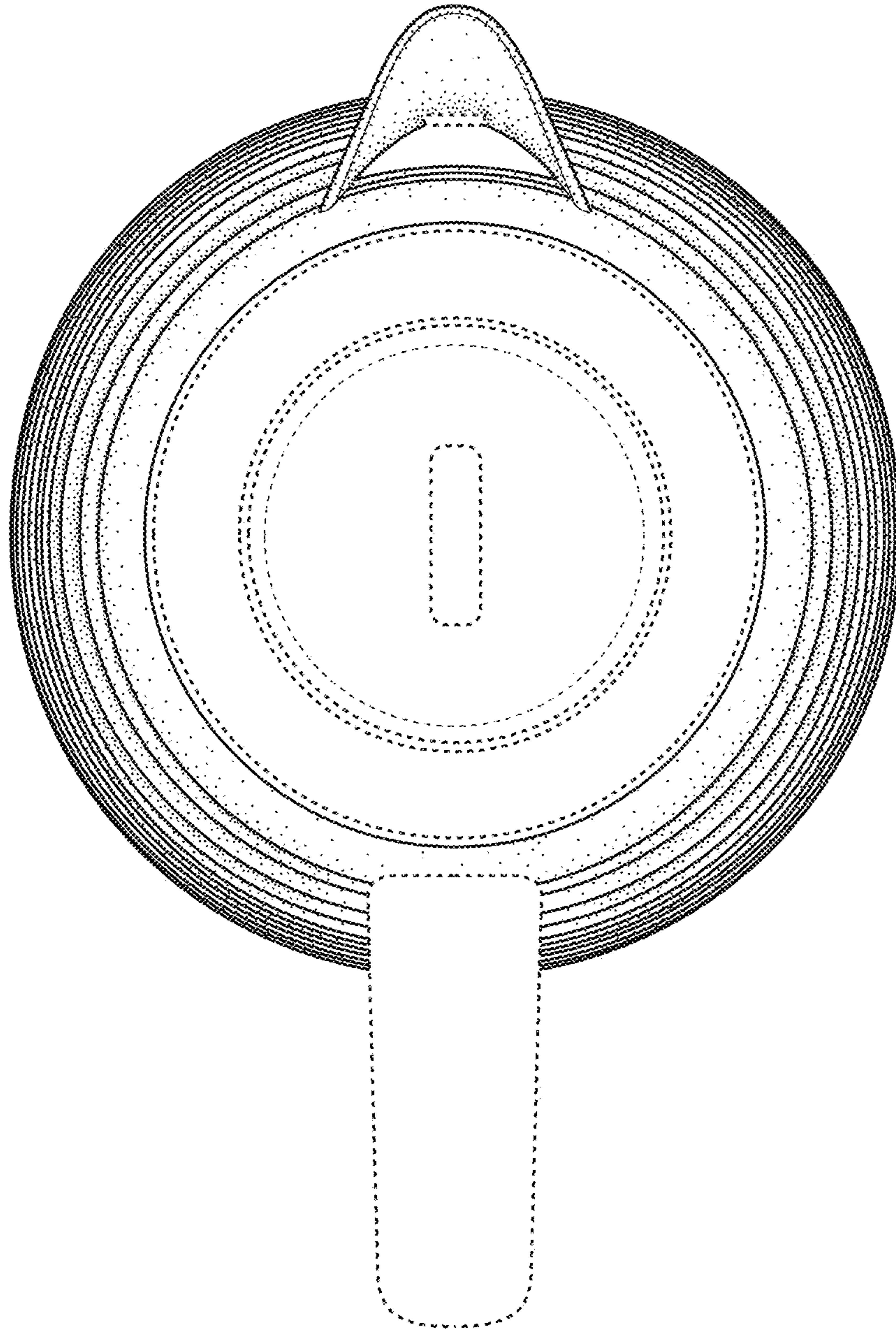

FIG. 6

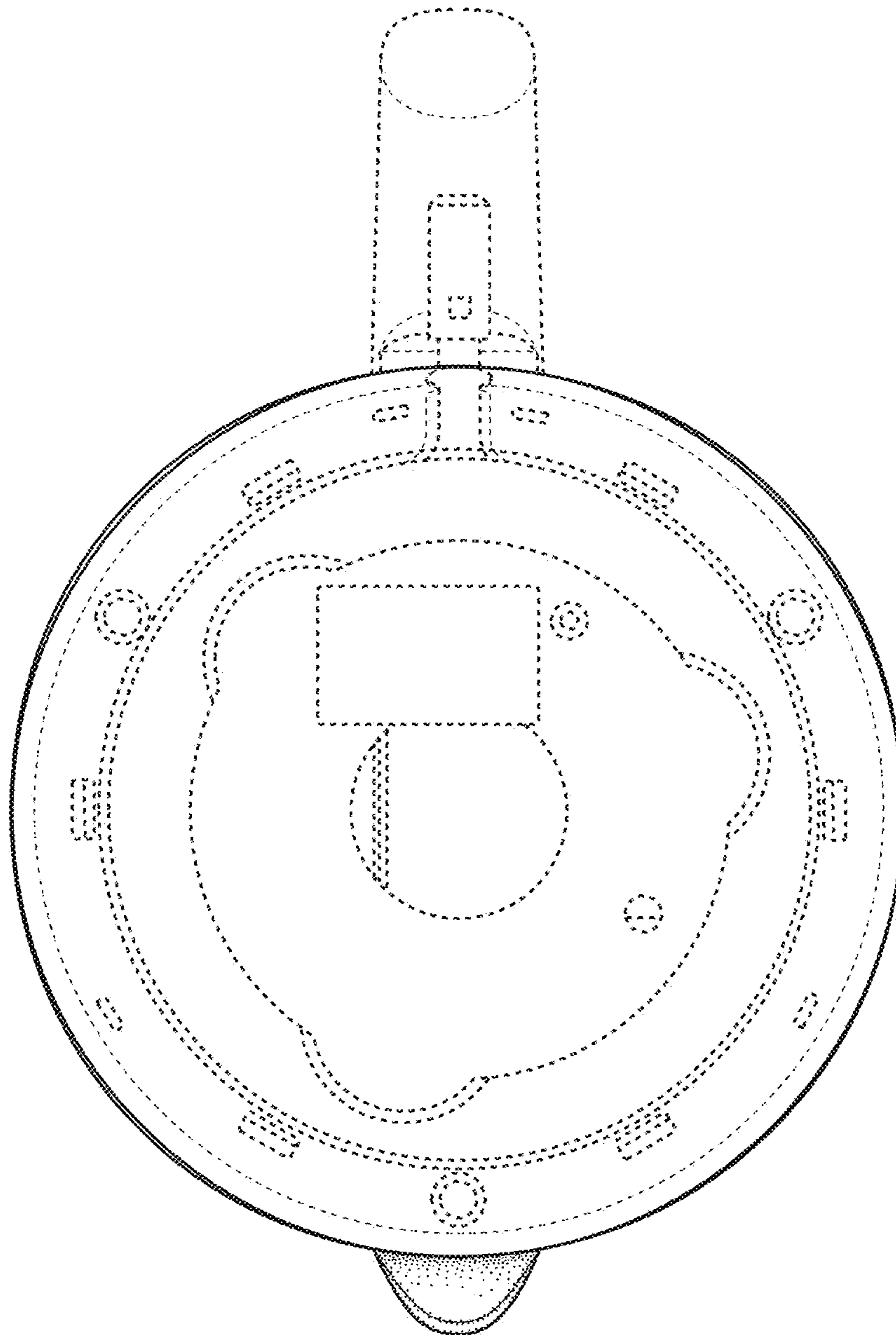

FIG. 7