



US00D868221S

(12) **United States Design Patent**
Miura et al.

(10) **Patent No.:** **US D868,221 S**

(45) **Date of Patent:** **** Nov. 26, 2019**

(54) **BATHTUB**

(71) Applicant: **TOTO, Ltd.**, Kitakyushu-shi, Fukuoka (JP)

(72) Inventors: **Osamu Miura**, Kitakyushu (JP); **Yuji Yoshioka**, Kitakyushu (JP)

(73) Assignee: **TOTO, Ltd.**, Kitakyushu-shi, Fukuoka (JP)

(**) Term: **15 Years**

(21) Appl. No.: **29/616,061**

(22) Filed: **Sep. 1, 2017**

(30) **Foreign Application Priority Data**

Mar. 7, 2017 (TW) 106301115

(51) **LOC (12) Cl.** **23-02**

(52) **U.S. Cl.**
USPC **D23/277**

(58) **Field of Classification Search**
USPC ... D23/277-279, 280.1, 280.2, 280.3, 280.4,
D23/304-307; D24/204-205
CPC A47K 3/006; A47K 3/02; A47K 3/022;
E05C 9/16
See application file for complete search history.

(56) **References Cited**

U.S. PATENT DOCUMENTS

D546,925 S * 7/2007 Bruce D23/277
D614,738 S * 4/2010 Lebrun D23/277

D656,227 S * 3/2012 Erli D23/278
D725,244 S * 3/2015 Baldelli D23/278
D761,399 S * 7/2016 Kuzman D23/277
D825,037 S * 8/2018 Bowen D23/277
D825,722 S * 8/2018 Burnstein D23/280.1
D837,953 S * 1/2019 Bowen D23/277

OTHER PUBLICATIONS

TOTO Zero-Gravity Flotation Tub [Apr. 18, 2018] found online [Jan. 16, 2019]—<https://www.pmmag.com/articles/101321-toto-zero-gravity-flotation-tub>.*

* cited by examiner

Primary Examiner — Lakiya G Rogers

Assistant Examiner — John A Voytek

(74) *Attorney, Agent, or Firm* — Banner & Witcoff, Ltd.

(57) **CLAIM**

The ornamental design for a bathtub, as shown and described.

DESCRIPTION

FIG. 1 is a front perspective view of a bathtub showing our new design;
FIG. 2 is a rear perspective view thereof;
FIG. 3 is a front view thereof;
FIG. 4 is a rear view thereof;
FIG. 5 is a right side view thereof, the left side view being a mirror image;
FIG. 6 is a top view thereof; and,
FIG. 7 is a bottom view thereof.

1 Claim, 6 Drawing Sheets

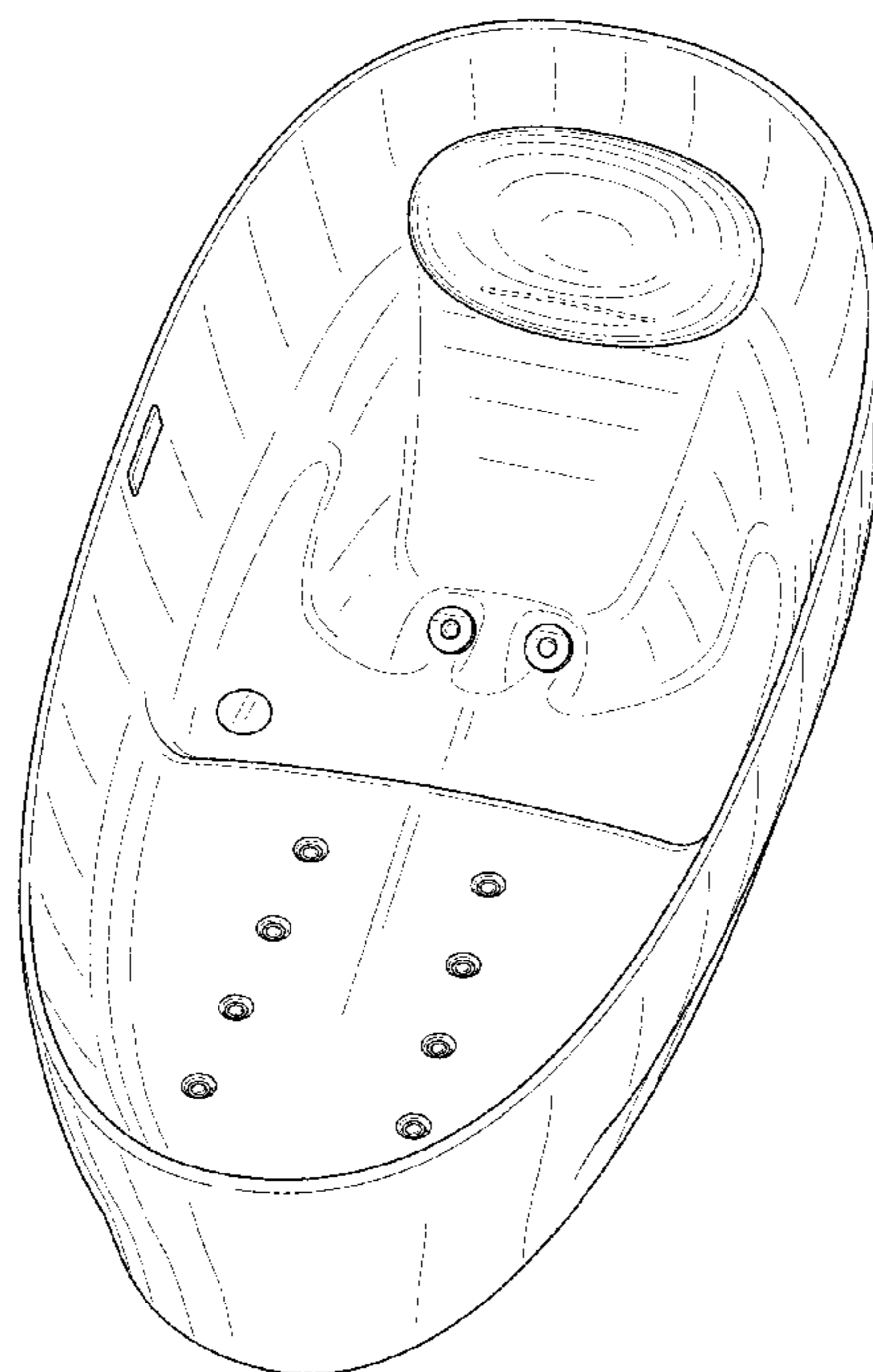

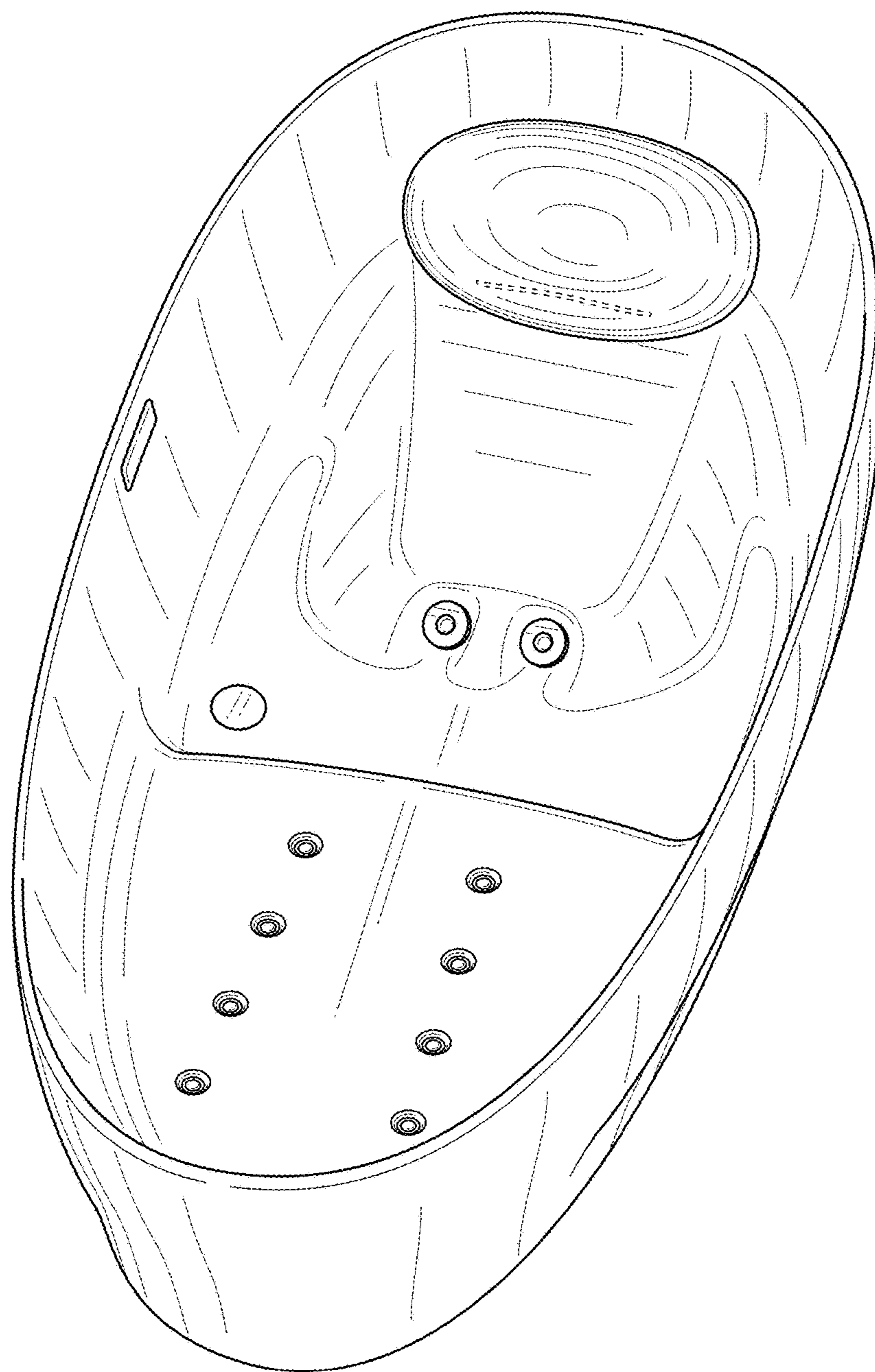

FIG. 1

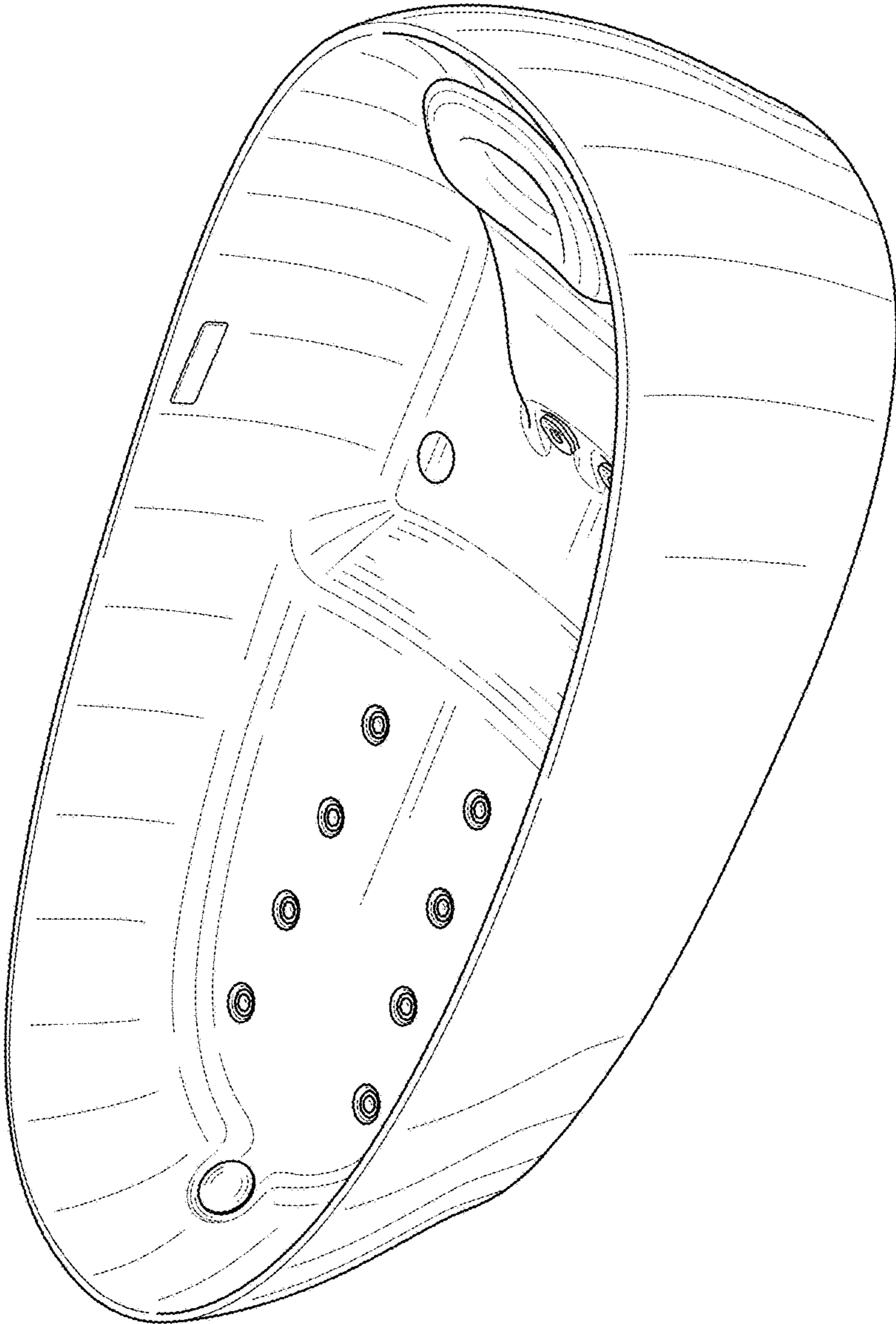

FIG. 2

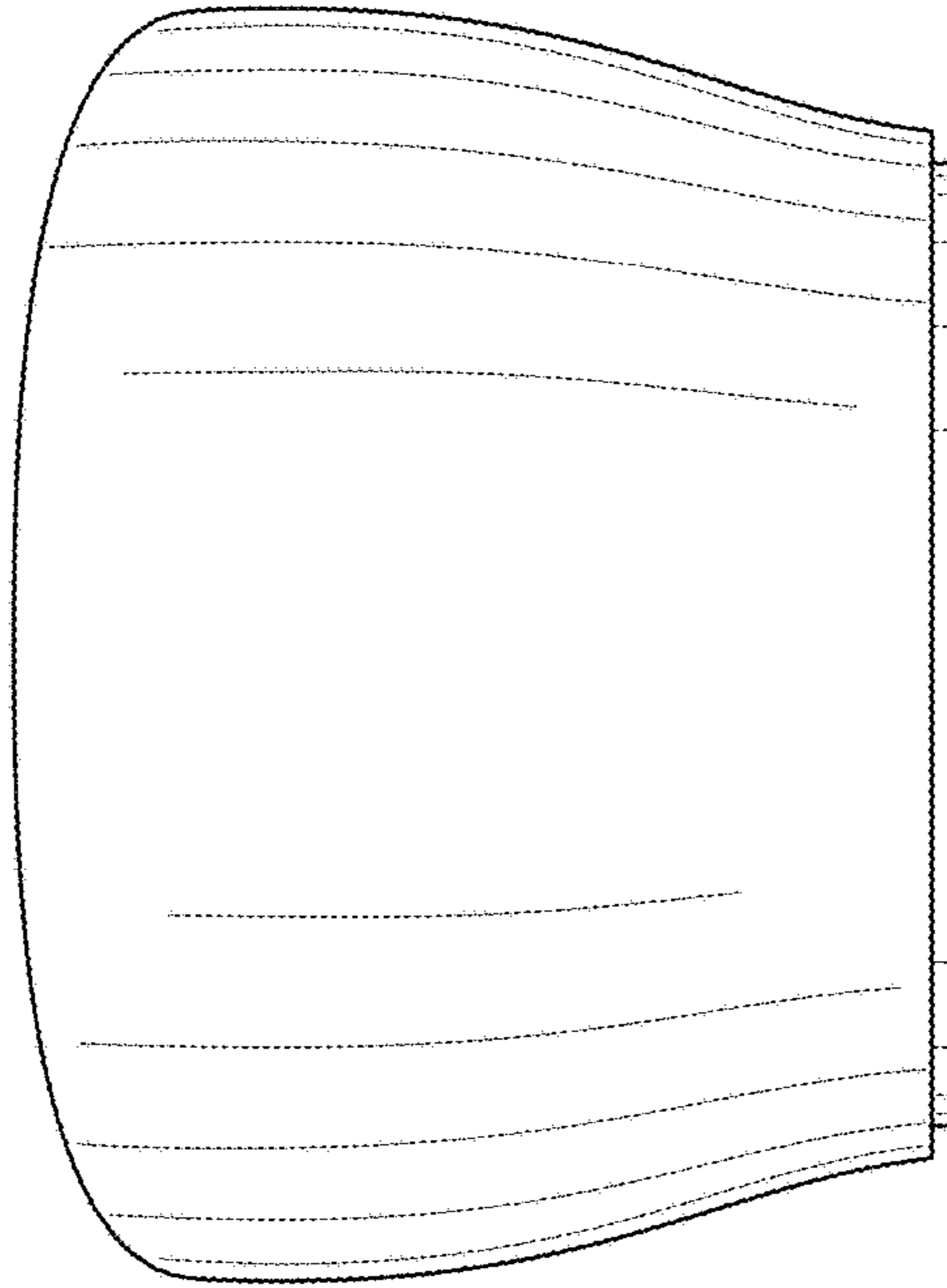

FIG. 4

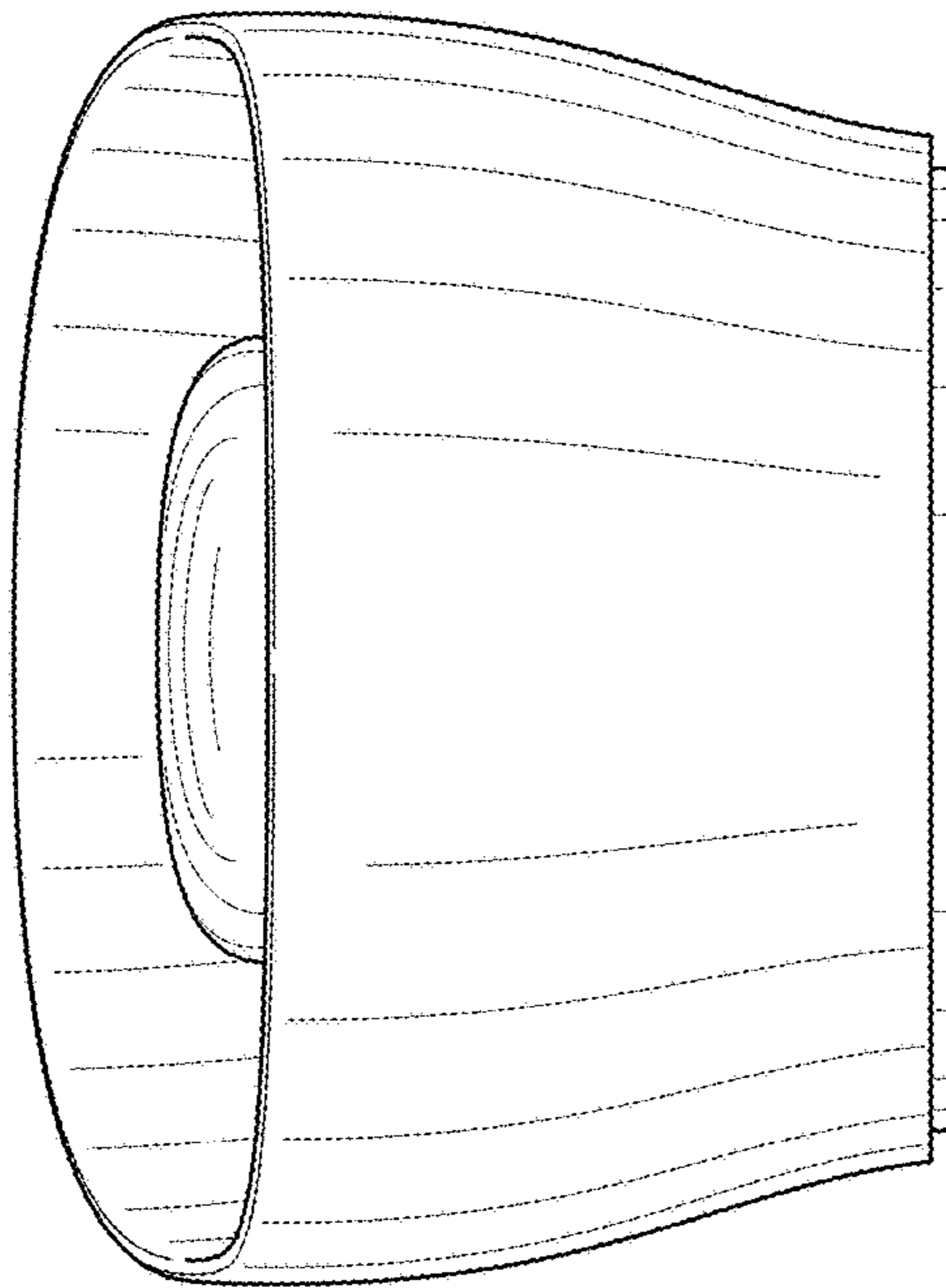

FIG. 3

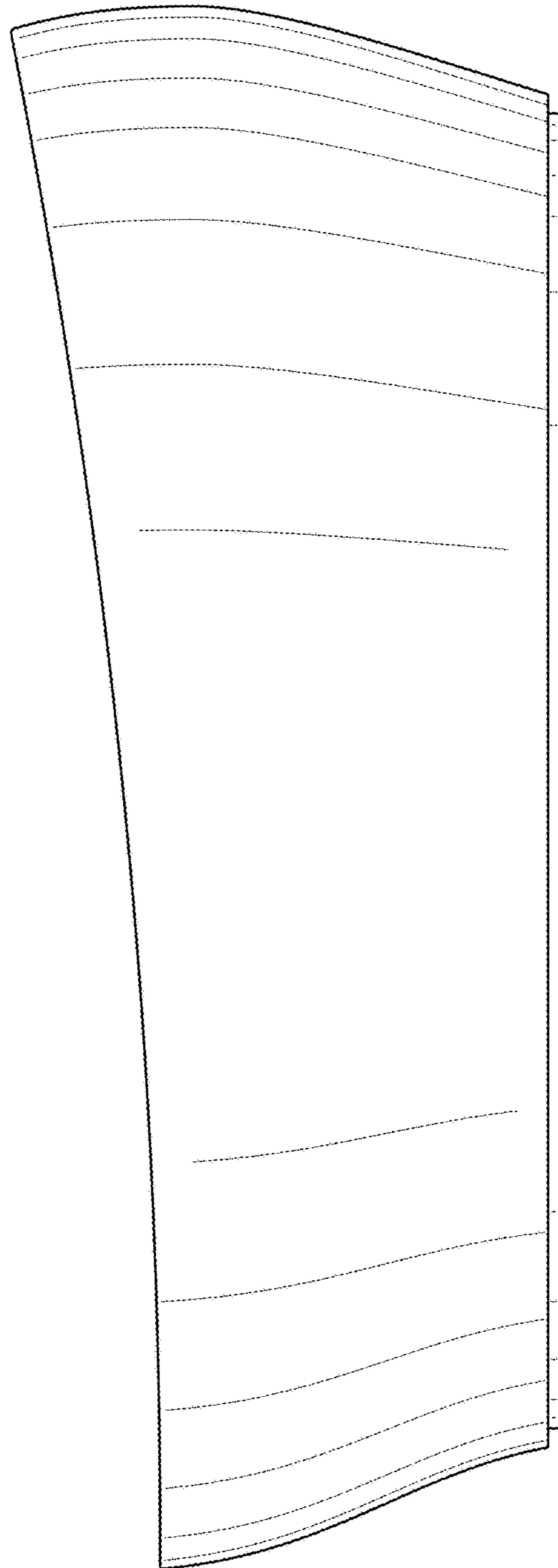

FIG. 5

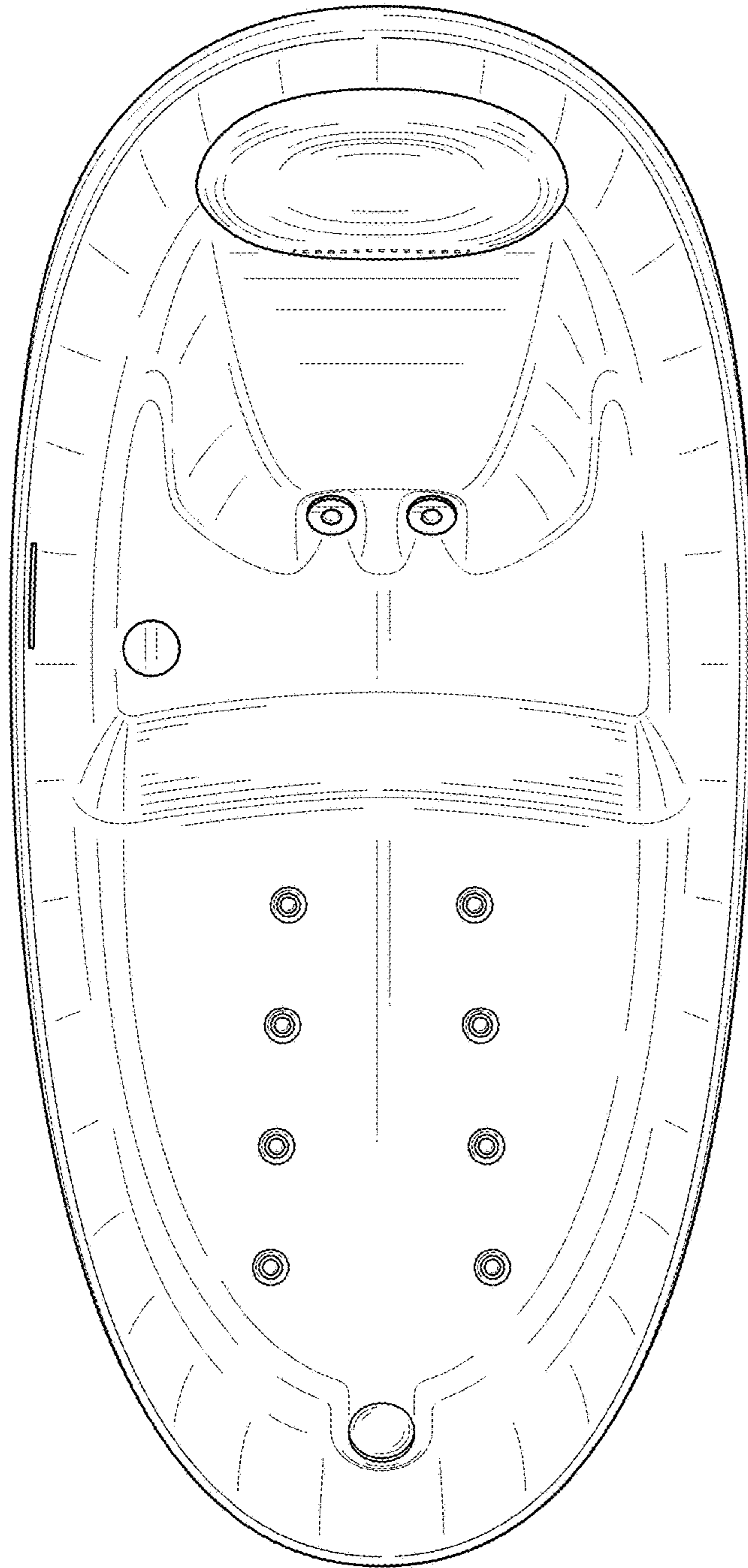

FIG. 6

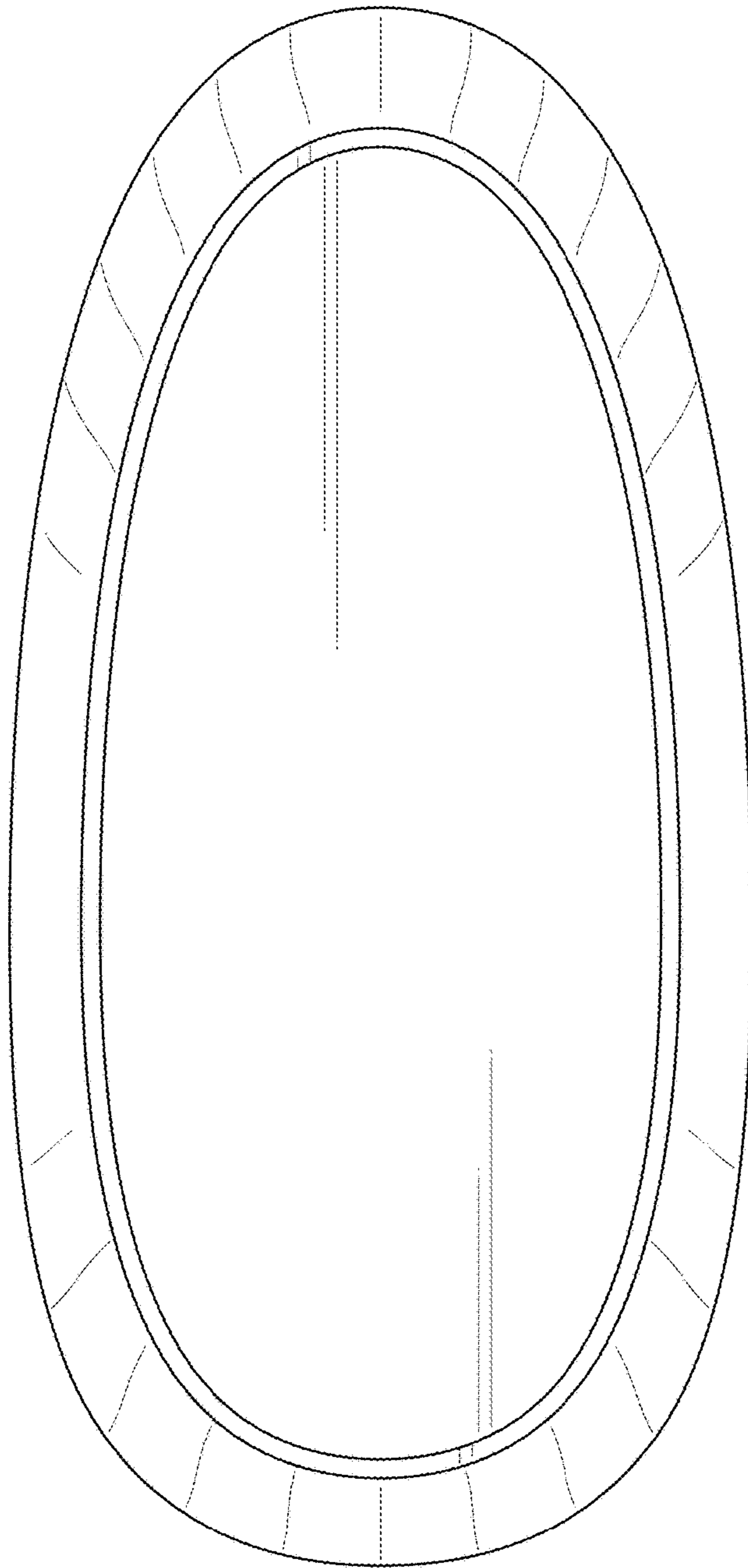

FIG. 7