



US00D868175S

(12) **United States Design Patent** (10) **Patent No.:** **US D868,175 S**
Chen (45) **Date of Patent:** **** Nov. 26, 2019**

(54) **TOY DUMP TRUCK**
(71) Applicant: **Bo Chen**, Guangdong (CN)
(72) Inventor: **Bo Chen**, Guangdong (CN)
(73) Assignee: **Shantou P&C Plastic Products Company Limited**, Guangdong (CN)
(**) Term: **15 Years**
(21) Appl. No.: **29/666,369**
(22) Filed: **Oct. 12, 2018**
(30) **Foreign Application Priority Data**

Jul. 17, 2018 (CN) 2018 3 0384742

(51) **LOC (12) Cl.** **21-01**
(52) **U.S. Cl.**
USPC **D21/552**; D12/83
(58) **Field of Classification Search**
USPC D12/86, 88, 90-92, 164, 173, 184-186,
D12/190, 196; D21/419, 421, 423-426,
D21/433-434, 548, 549, 550, 552, 559,
D21/561
CPC A63H 17/26; A63H 17/262; A63H 17/264;
A63H 17/266; A63H 17/36; A63H 17/38;
A63H 29/00; A63H 29/22; A63H 29/24;
A63H 30/04

See application file for complete search history.

(56) **References Cited**

U.S. PATENT DOCUMENTS

D258,972 S * 4/1981 Samuels D21/554
D259,797 S * 7/1981 Merchant D21/537
D262,391 S * 12/1981 Kanaoki D21/450
D263,977 S * 4/1982 Breneman D21/554
D271,315 S * 11/1983 Nottingham D21/431
D274,632 S * 7/1984 Terui D21/559
D281,000 S * 10/1985 Kuna D21/559

D281,987 S * 12/1985 Catelli D21/552
D287,522 S * 12/1986 Blumenthal D21/537
D289,069 S * 3/1987 Ohno D21/580
D289,309 S * 4/1987 Wilkes D21/554
D312,488 S * 11/1990 Kwan D21/551
5,372,534 A * 12/1994 Levy A63H 17/26
180/209
D362,035 S * 9/1995 Klawitter D21/554
D421,073 S * 2/2000 Wei 15/25
D425,142 S * 5/2000 Wei D21/552
D443,318 S * 6/2001 Tse D21/559
D454,602 S * 3/2002 Tse D21/552
D721,769 S * 1/2015 Johnson D21/552
D771,202 S * 11/2016 Gan D21/552
D771,203 S * 11/2016 Gan D21/552
D827,038 S * 8/2018 Exley D21/434
D840,477 S * 2/2019 Flores D21/548
D852,900 S * 7/2019 Zhou D21/552
2008/0166946 A1 * 7/2008 Gallagher A63H 17/06
446/428

(Continued)

Primary Examiner — Manpreet S Matharu
Assistant Examiner — Keith J Wilson
(74) *Attorney, Agent, or Firm* — Minder Law Group;
Willy H. Wong

(57) **CLAIM**

The ornamental design for a toy dump truck, as shown and described.

DESCRIPTION

FIG. 1 is a front view of a toy dump truck in accordance with the present invention.
FIG. 2 is a back view thereof.
FIG. 3 is a right view thereof.
FIG. 4 is a left view thereof.
FIG. 5 is a top view thereof; and,
FIG. 6 is a bottom view thereof.
The broken lines show portions of the toy dump truck that form no part of the claimed design.

1 Claim, 6 Drawing Sheets

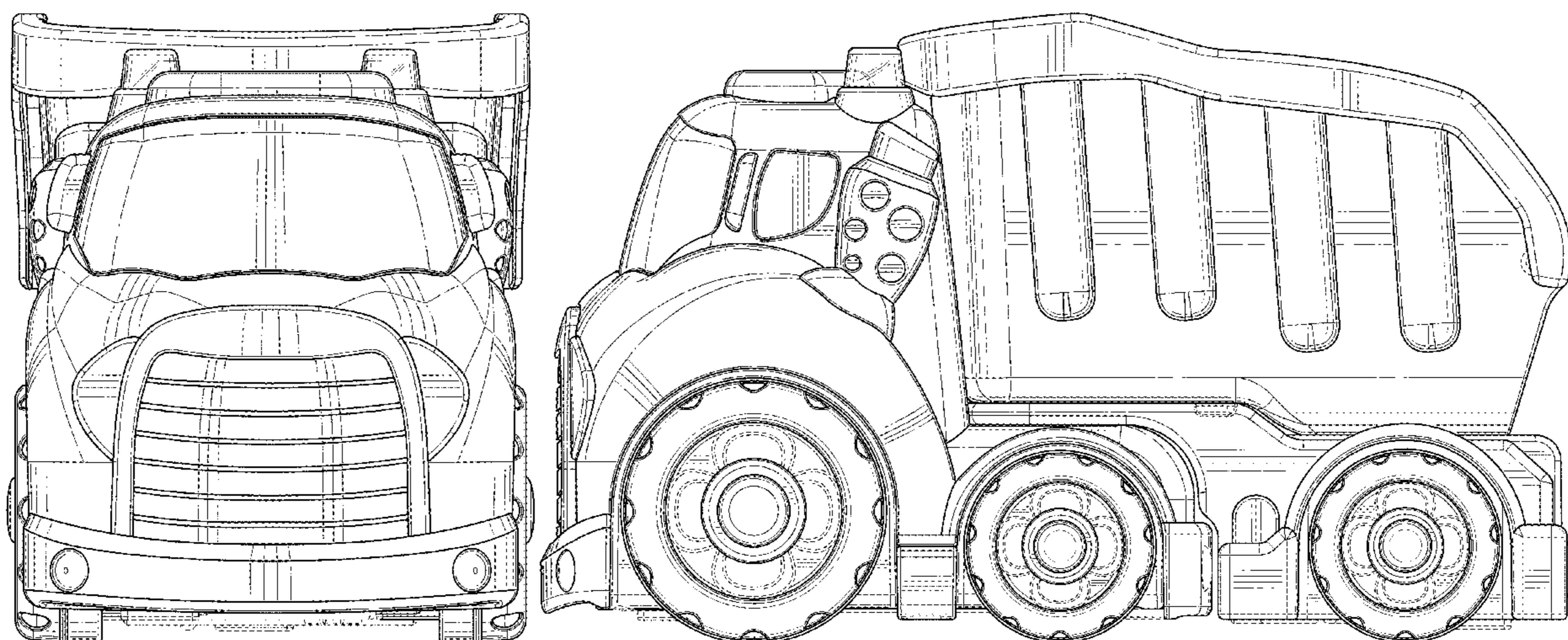

(56)

References Cited

U.S. PATENT DOCUMENTS

2008/0303336 A1* 12/2008 Whitfield B60W 10/184
298/17 R
2014/0170932 A1* 6/2014 Lee A63H 17/26
446/409

* cited by examiner

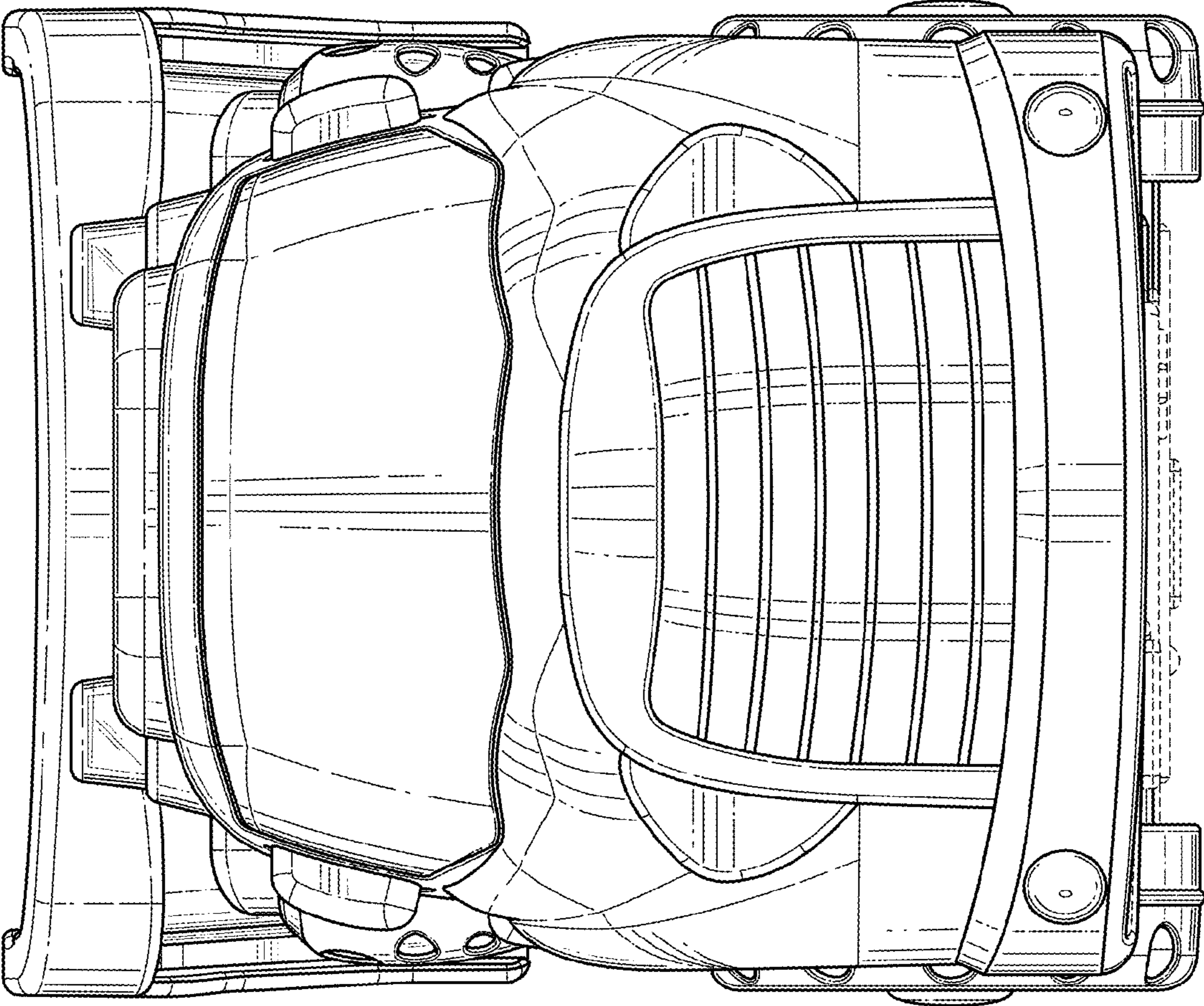

FIG. 1

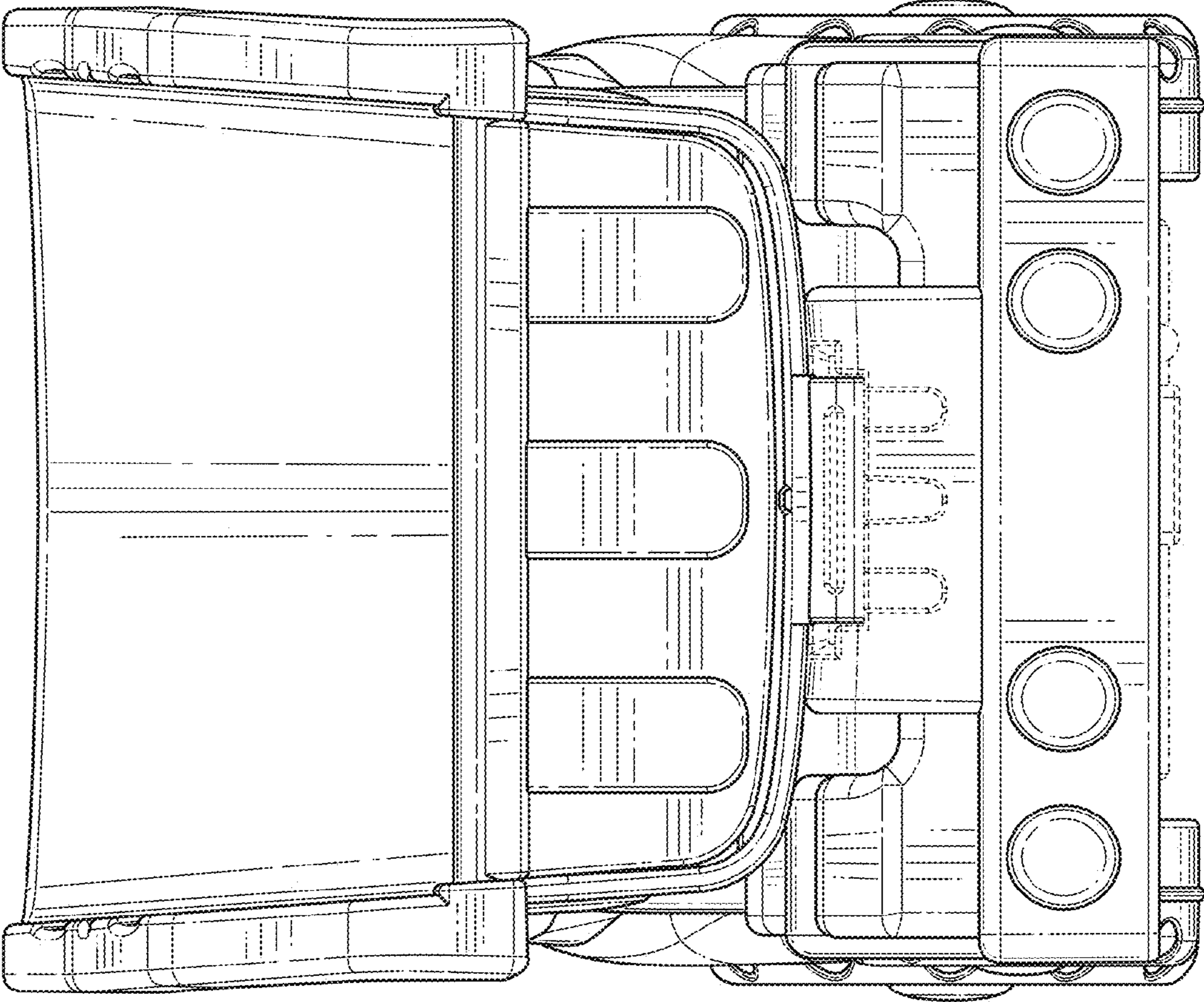

FIG. 2

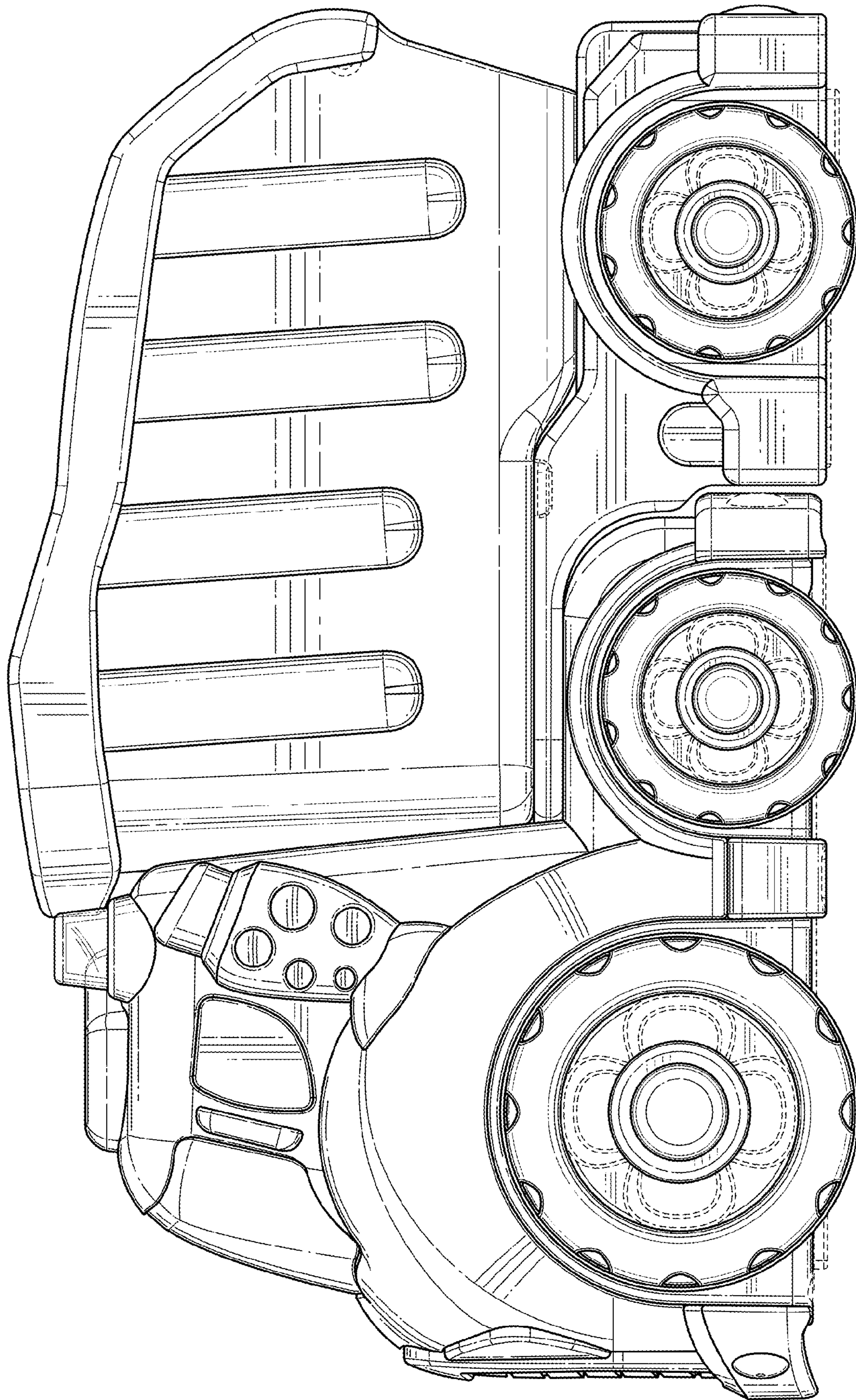

FIG. 3

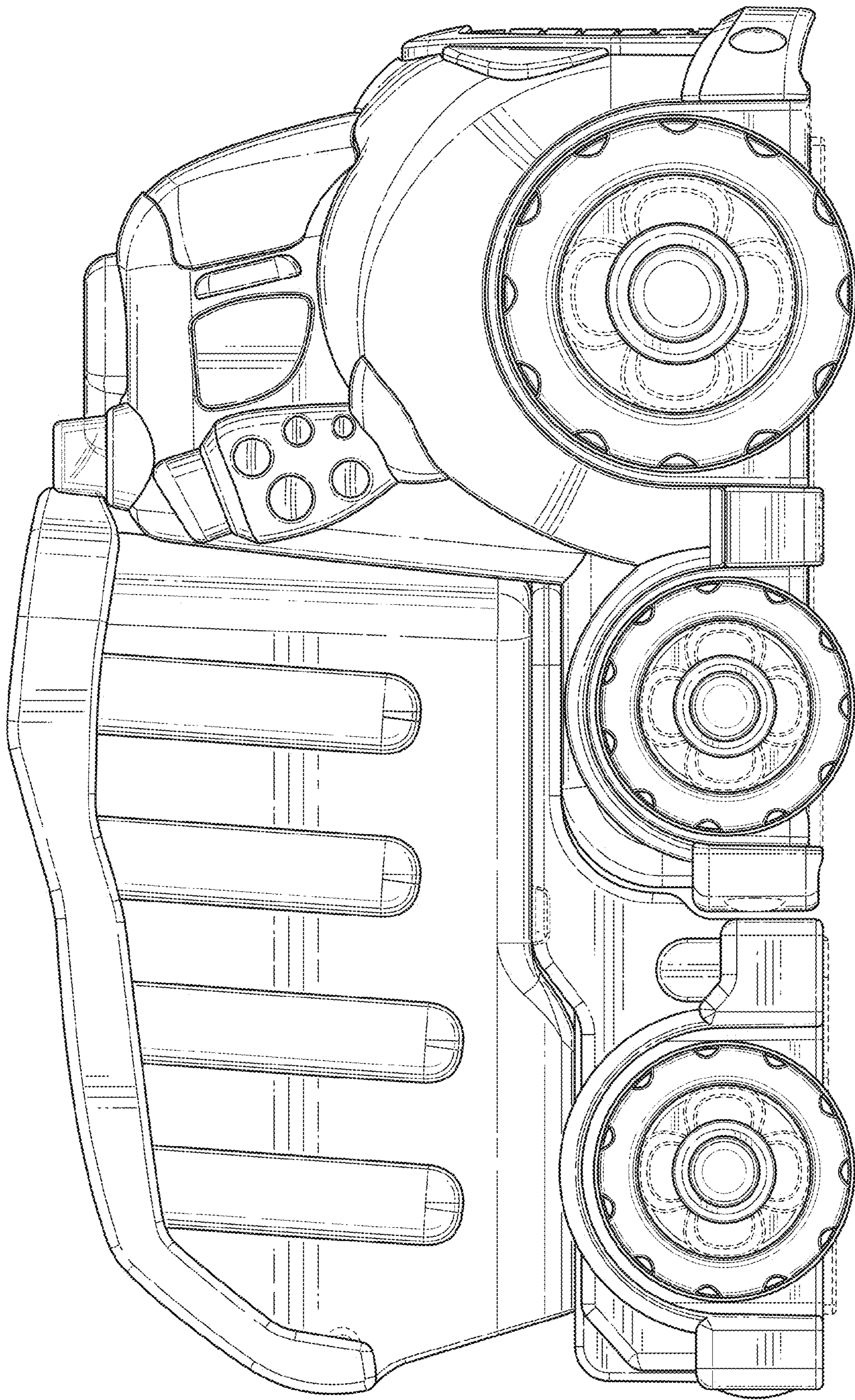

FIG. 4

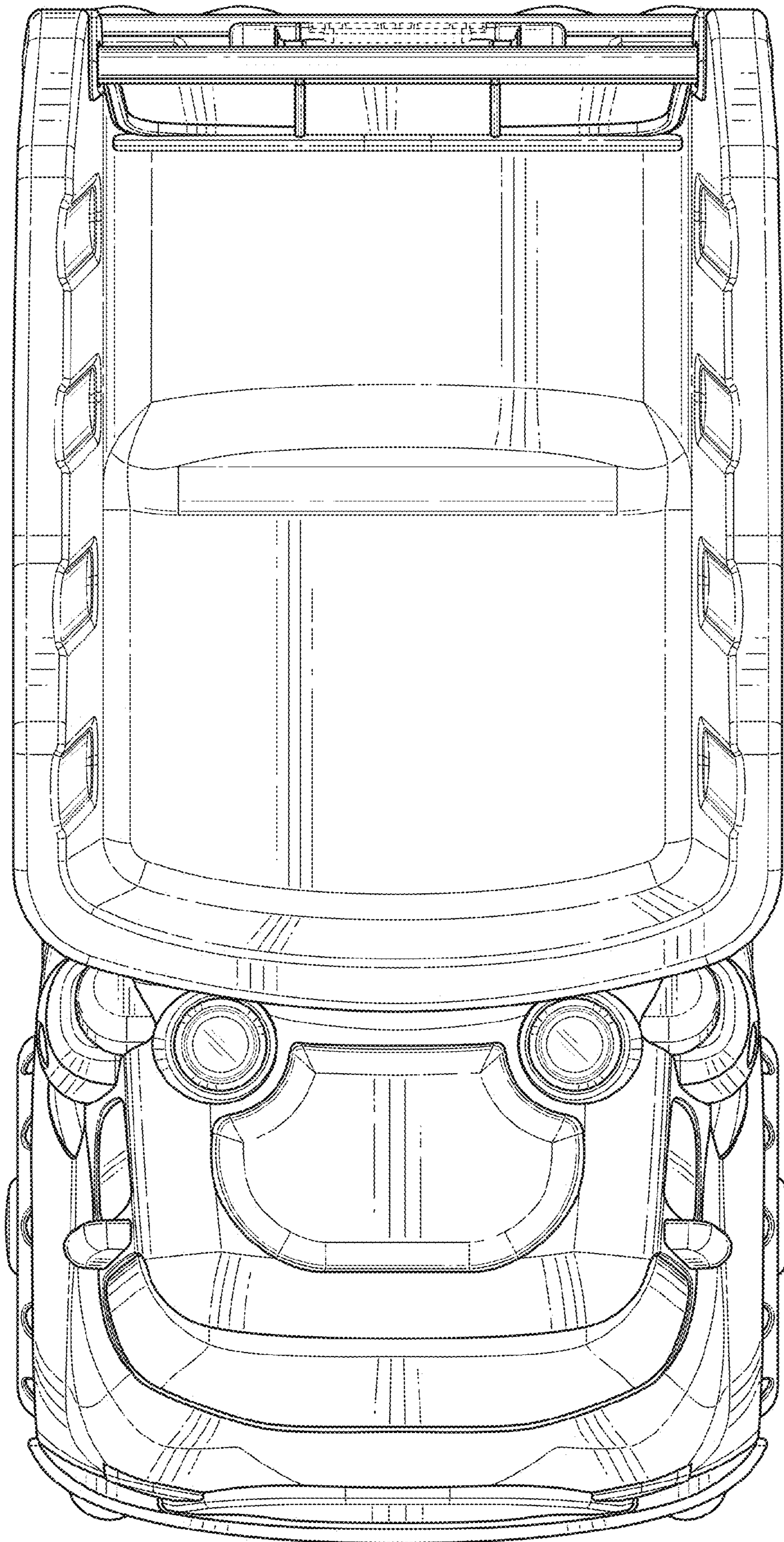

FIG. 5

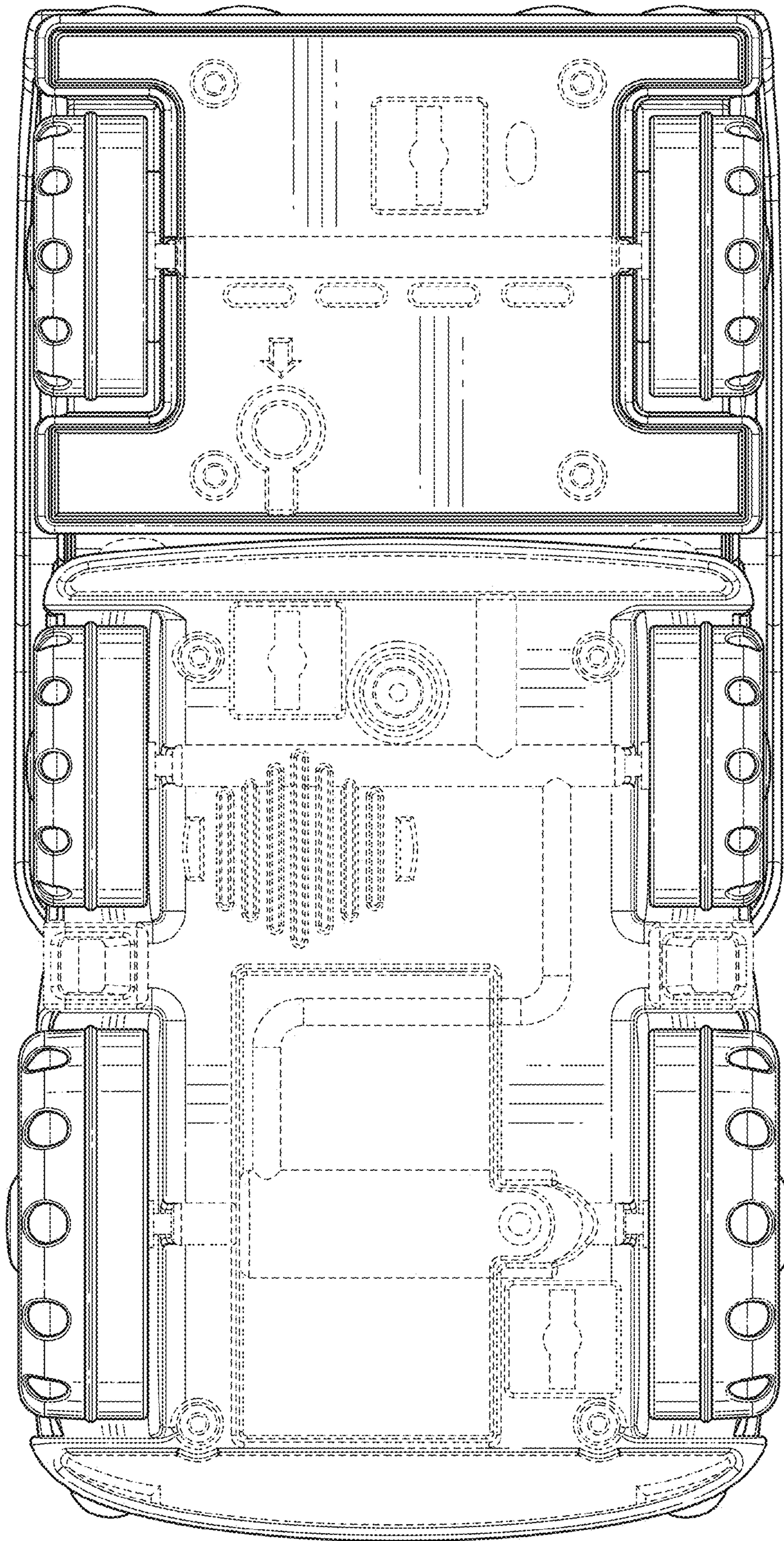

FIG. 6