

US00D868158S

(12) **United States Design Patent** (10) **Patent No.:** **US D868,158 S**  
**Swisher et al.** (45) **Date of Patent:** **\*\* \*Nov. 26, 2019**

(54) **FOLDABLE STENCIL**  
(71) Applicant: **INNOVATIVE ART CONCEPTS, LLC**, Ramsey, NJ (US)  
(72) Inventors: **John G. Swisher**, Mahwah, NJ (US); **Janna Makaeva**, Mahwah, NJ (US)  
(73) Assignee: **INNOVATIVE ART CONCEPTS, LLC**, Ramsey, NJ (US)  
(\*) Notice: This patent is subject to a terminal disclaimer.  
(\*\*) Term: **15 Years**  
(21) Appl. No.: **29/612,521**  
(22) Filed: **Aug. 1, 2017**  
(51) **LOC (12) Cl.** ..... **19-06**  
(52) **U.S. Cl.**  
USPC ..... **D19/40**  
(58) **Field of Classification Search**  
USPC ..... D10/62, 64; D19/37, 39, 40, 1; D20/22, D20/27  
CPC ..... B05C 1/027; B05C 17/06; B41M 1/12; B41N 1/24; B42F 5/06; B43L 13/20; B43L 13/201; G09B 11/04  
See application file for complete search history.

(56) **References Cited**  
U.S. PATENT DOCUMENTS  
856,196 A \* 6/1907 Lehman ..... A63F 9/088 229/92.8  
1,708,968 A \* 4/1929 Gianelloni, Jr. .... B05C 17/06 101/128  
2,066,477 A \* 1/1937 Levin ..... G09B 11/04 101/115

(Continued)

Primary Examiner — Elizabeth A. Albert

(74) *Attorney, Agent, or Firm* — FisherBroyles, LLP; Andrew K. Gonsalves, Esq.  
(57) **CLAIM**  
The ornamental design for a foldable stencil, as shown and described.

**DESCRIPTION**

FIG. 1 is a top plan view of the outside of the foldable stencil showing our new design folded;  
FIG. 2 is a bottom plan view thereof;  
FIG. 3 is a front view thereof;  
FIG. 4 is a rear view thereof;  
FIG. 5 is a left side view thereof;  
FIG. 6 is a right side view thereof;  
FIG. 7 is a top plan view thereof unfolded;  
FIG. 8 is a top plan view of the inside thereof;  
FIG. 9 is a top plan view of the inside thereof with the two side panels folded inward;  
FIG. 10 is a top plan view of the inside thereof with only the left side panel folded inward;  
FIG. 11 is a top plan view of the inside thereof with only the right side panel folded inward;  
FIG. 12 is a top plan view of the inside thereof with only the top panel folded downward;  
FIG. 13 is a top perspective inside view thereof unfolded;  
FIG. 14 is another top perspective inside view thereof;  
FIG. 15 is a top plan view of the outside thereof folded closed in use;  
FIG. 16 is a bottom plan view of the outside thereof;  
FIG. 17 is a top plan view of the outside thereof unfolded;  
FIG. 18 is a top plan view of the inside thereof;  
FIG. 19 is a top plan view of the inside thereof with only the left side panel folded inward;  
FIG. 20 is a top plan view of the inside thereof with only the right side panel folded inward; and,  
FIG. 21 is a top plan view thereof with only the top panel folded downward.  
The broken lines are included to show portions of the foldable stencil that form no part of the claimed design.

**1 Claim, 17 Drawing Sheets**

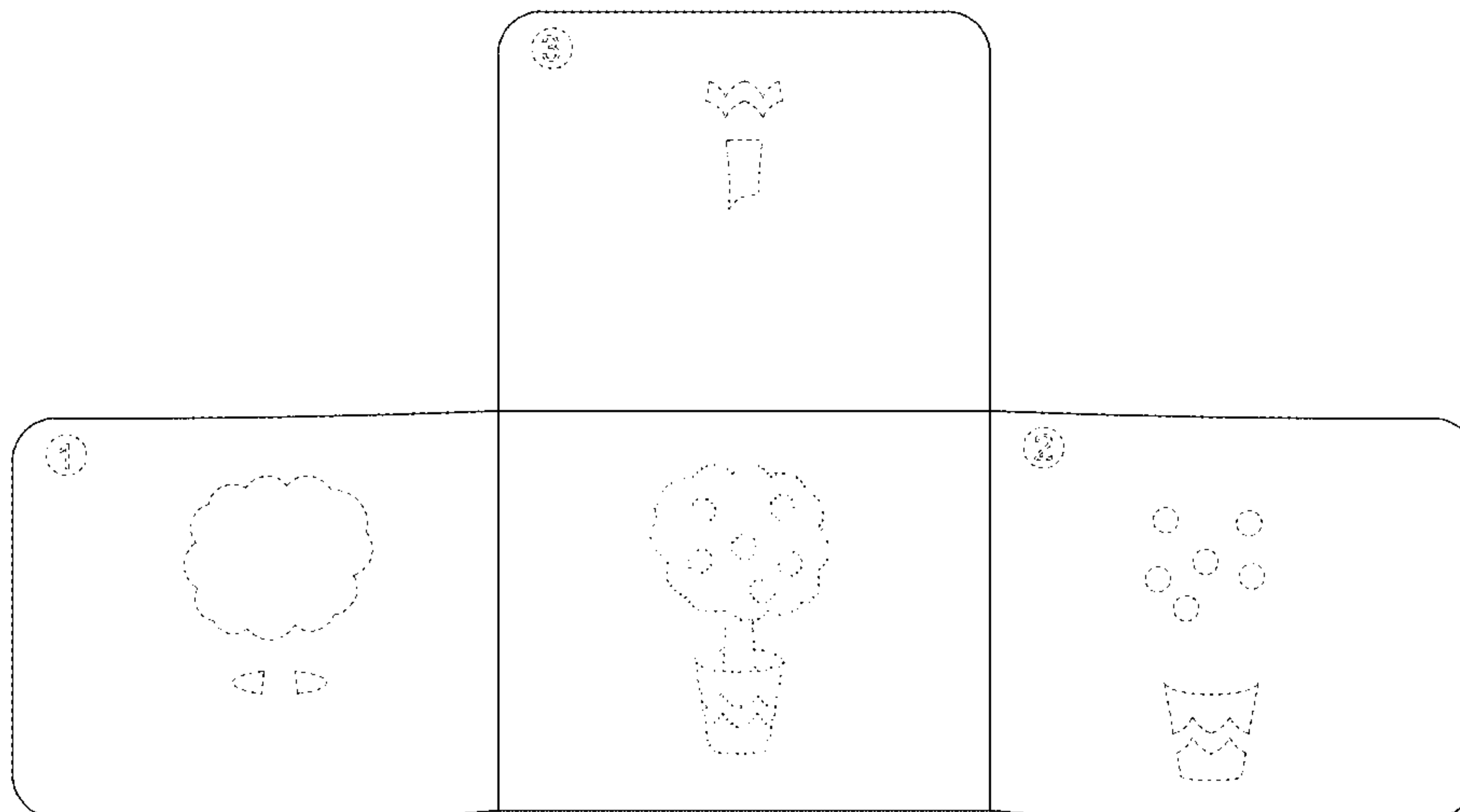

(56)

**References Cited**

U.S. PATENT DOCUMENTS

3,354,560 A \* 11/1967 Kuenzel ..... B42D 15/042  
40/788

3,758,695 A \* 9/1973 Goodman ..... G09B 11/04  
434/84

3,892,411 A \* 7/1975 High ..... A63F 9/0613  
273/155

4,205,849 A \* 6/1980 Perkins ..... A63F 9/088  
273/155

4,373,730 A \* 2/1983 Koltz ..... A63F 9/0613  
273/155

4,507,087 A \* 3/1985 Stevenson ..... A63H 33/22  
40/406

D345,996 S \* 4/1994 Bates ..... D21/480

D351,872 S \* 10/1994 Bates ..... D21/478

5,482,295 A \* 1/1996 Phelan ..... A63F 9/06  
273/459

6,519,781 B1 \* 2/2003 Berns ..... A41D 13/0153  
2/267

6,978,562 B2 \* 12/2005 Frenkel ..... B42D 15/042  
206/232

7,156,017 B1 \* 1/2007 Ingraselino ..... B41M 1/12  
101/115

8,590,448 B2 \* 11/2013 Swisher ..... B05C 1/027  
101/127

9,821,545 B2 \* 11/2017 Swisher ..... B05C 1/027

2007/0164553 A1 \* 7/2007 Katz ..... A63H 33/38  
281/38

2010/0275796 A1 \* 11/2010 Lee ..... B44D 2/007  
101/127

\* cited by examiner

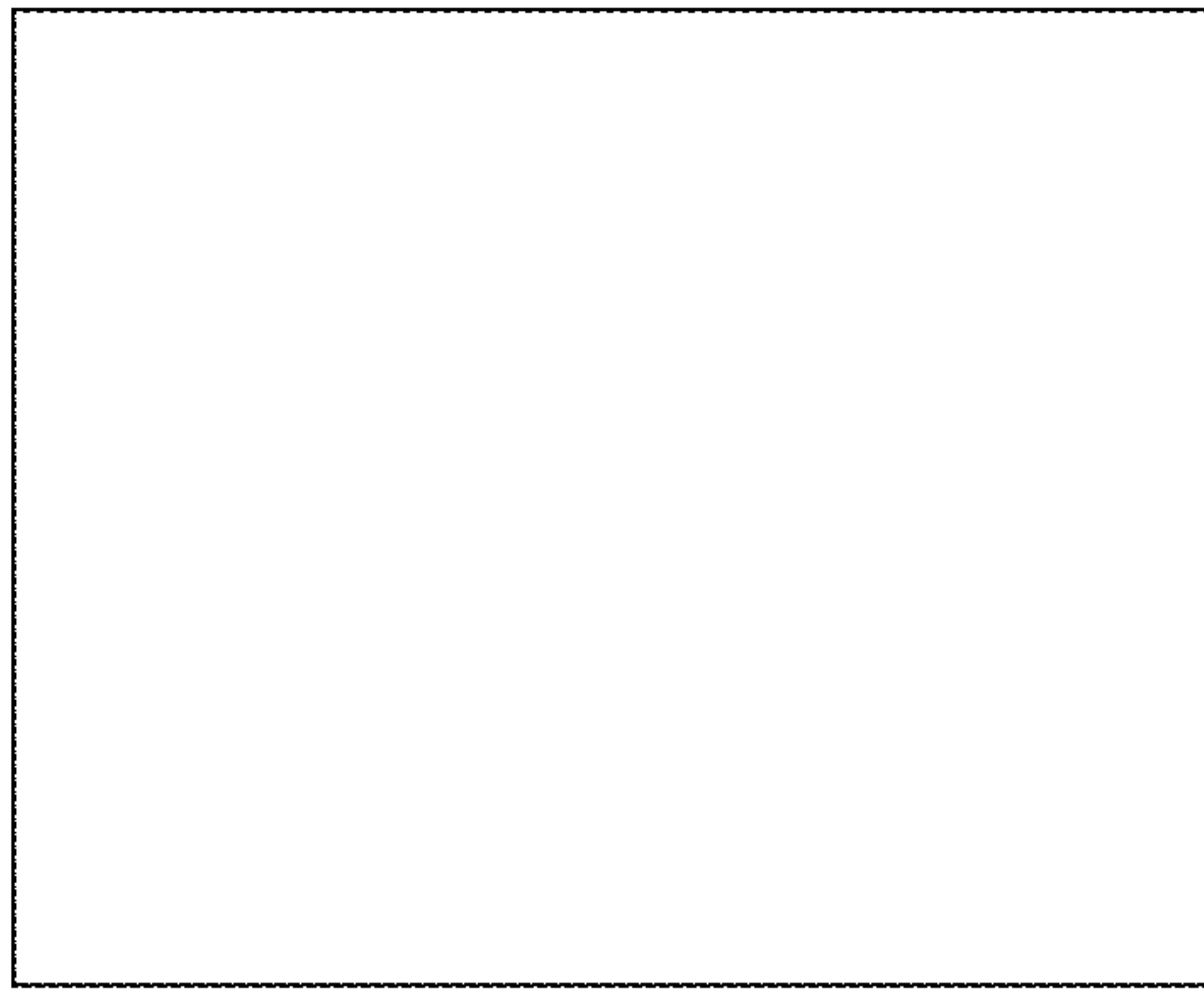

FIG. 1

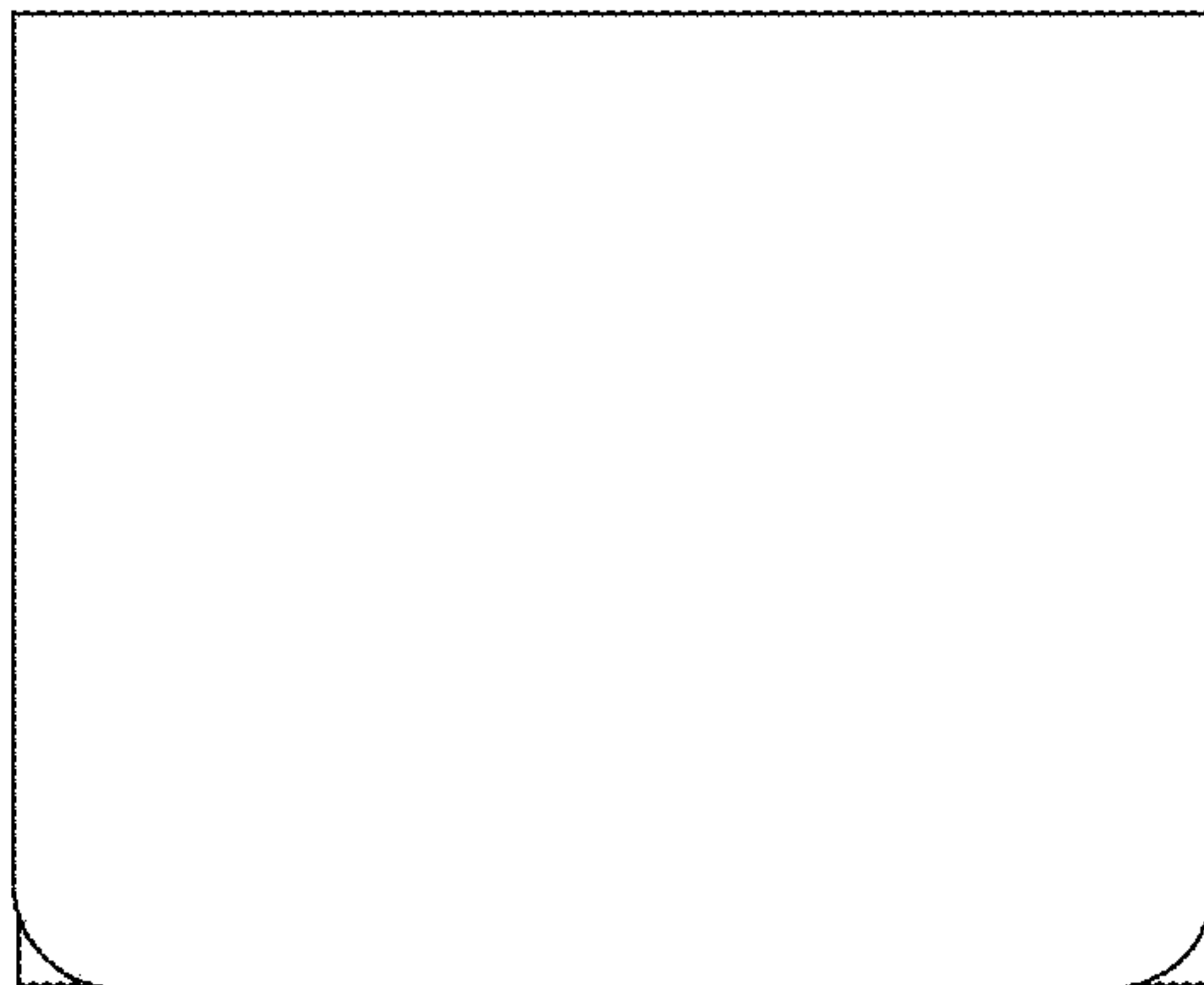

FIG. 2

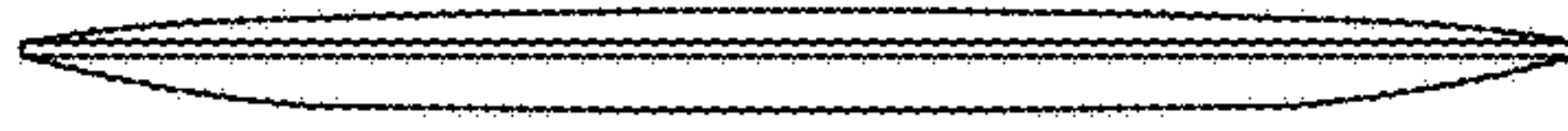

FIG. 3

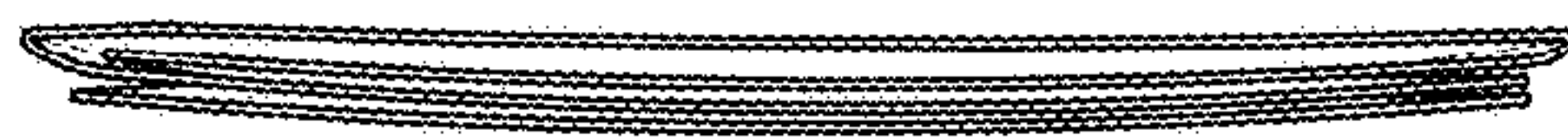

FIG. 4

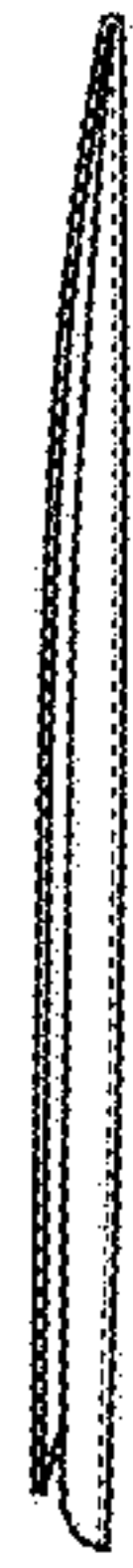

FIG. 5

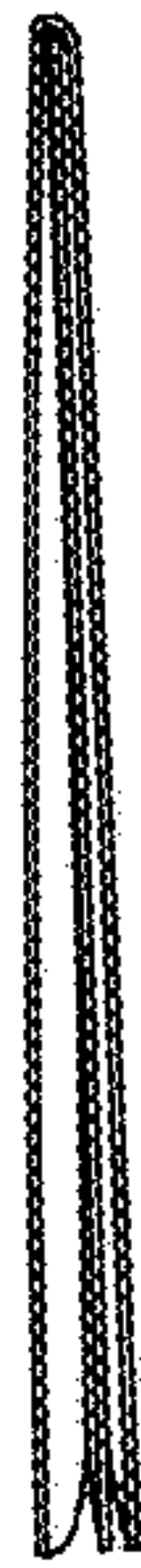

FIG. 6

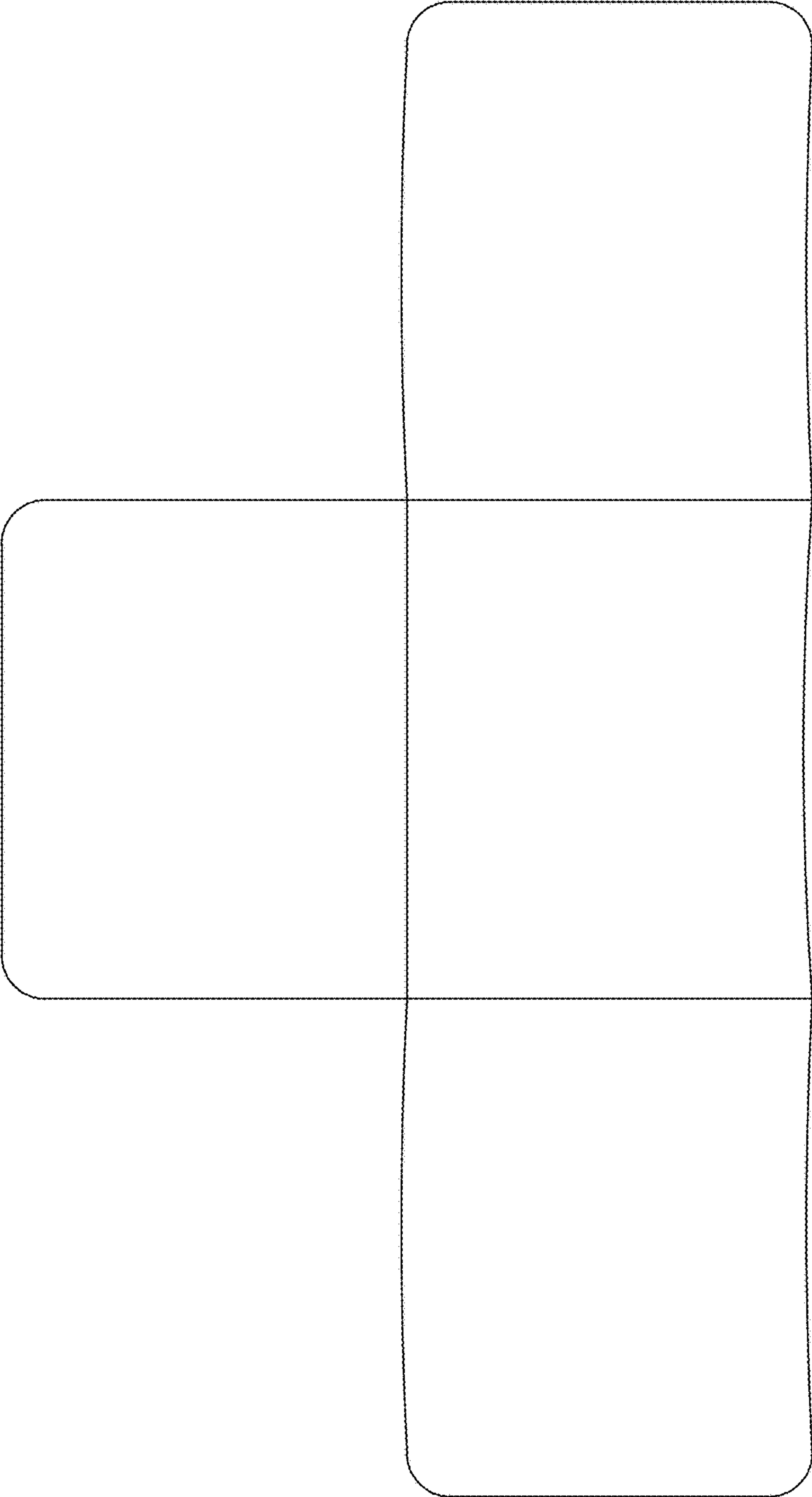

FIG. 7

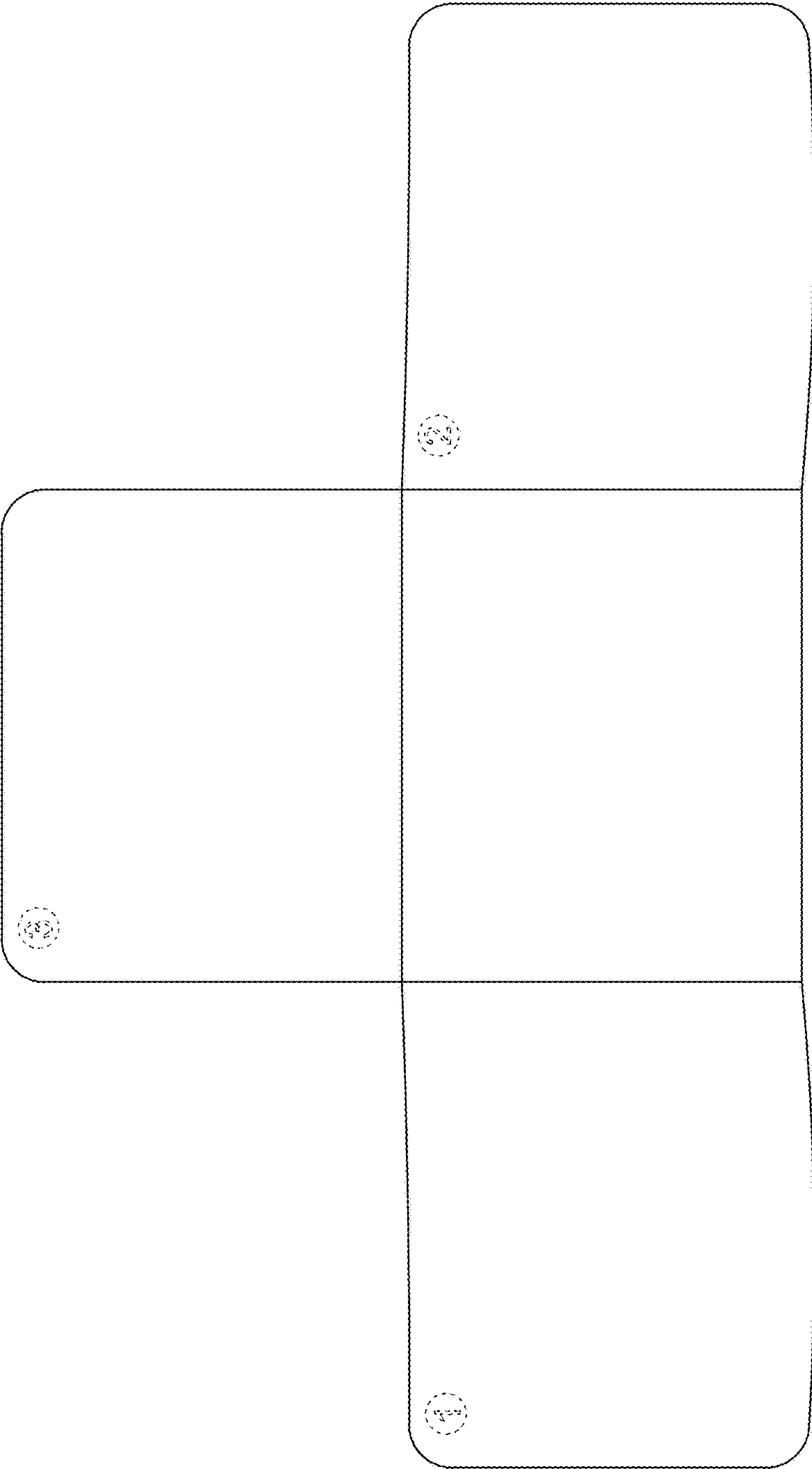

FIG. 8

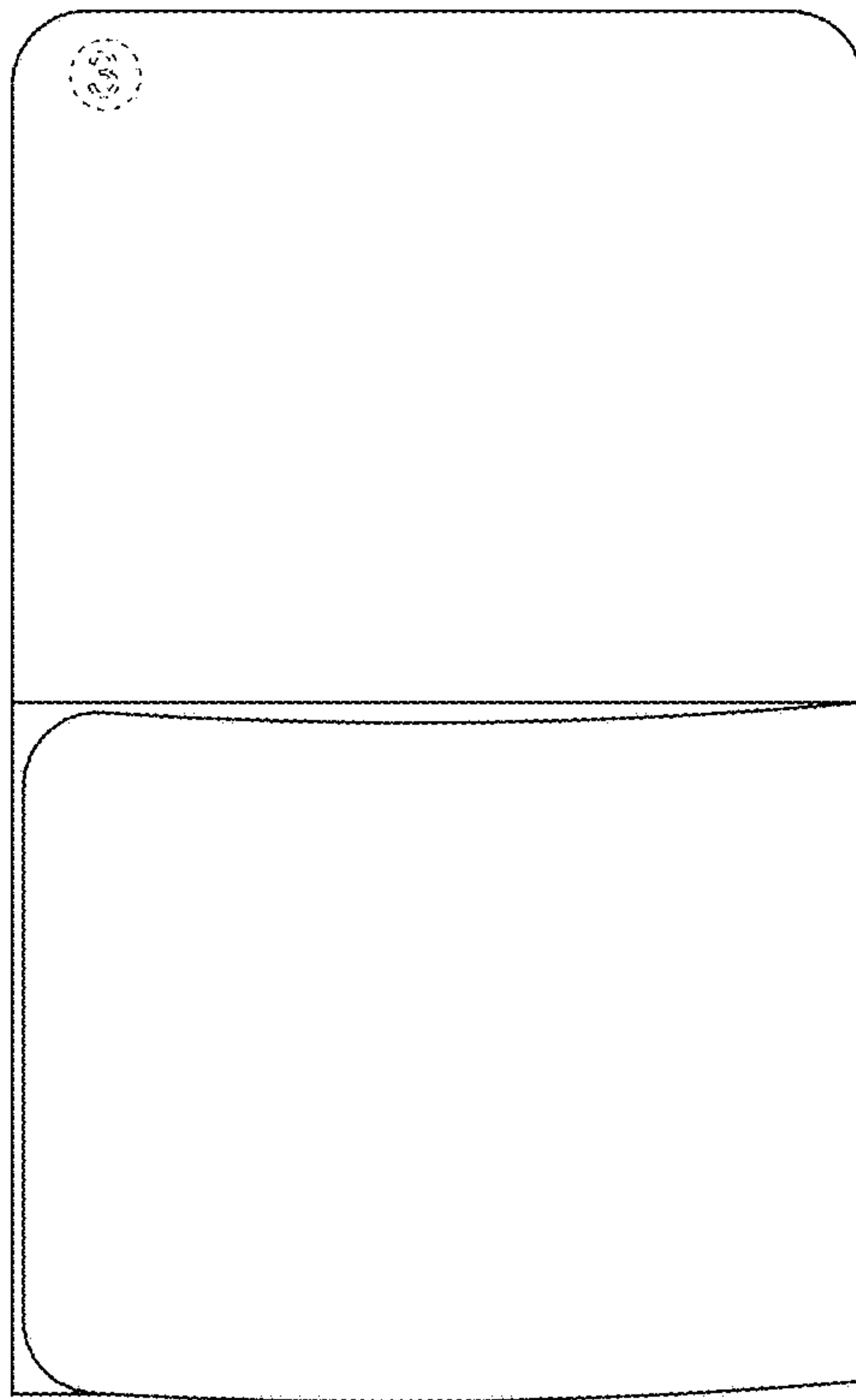

FIG. 9



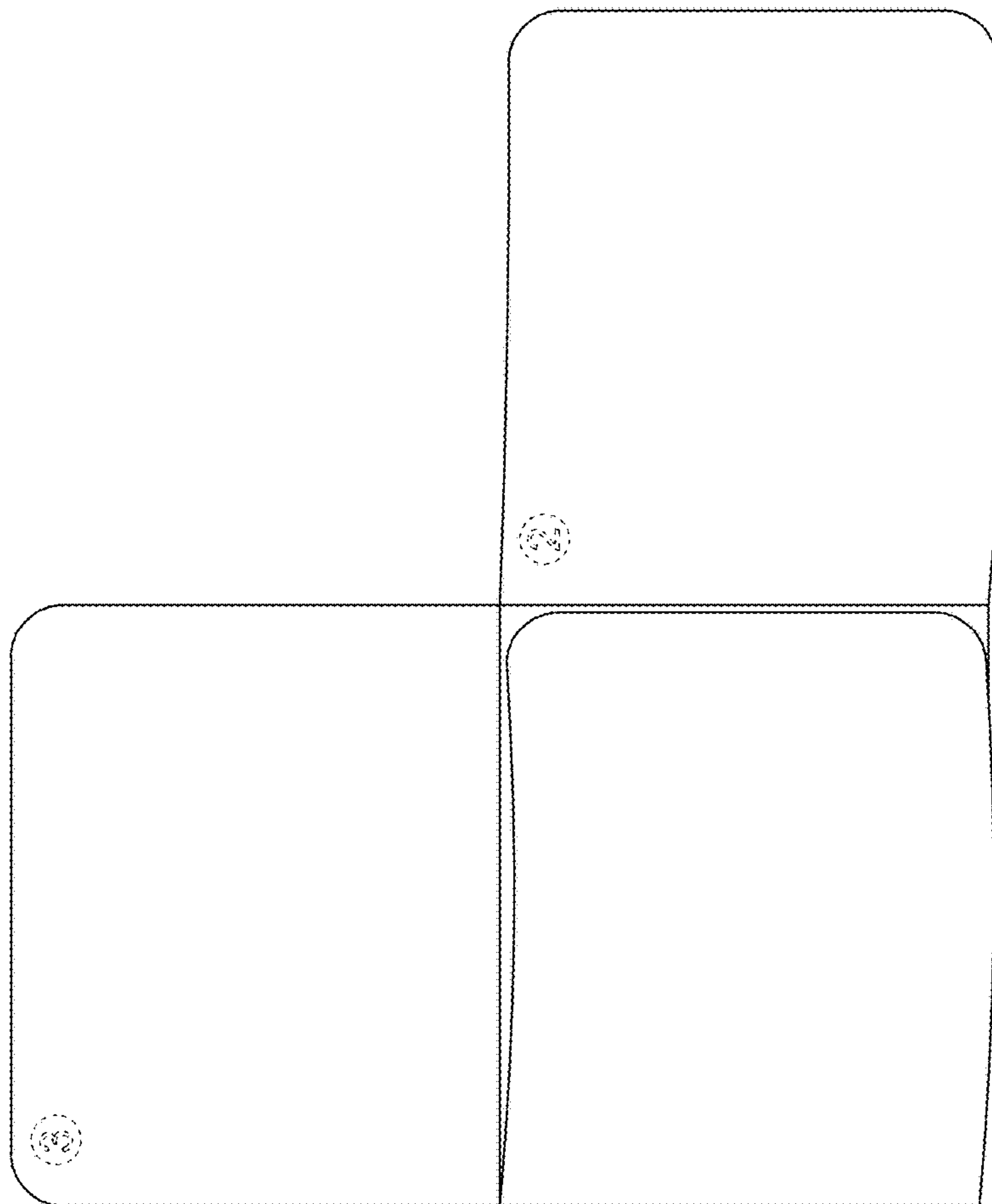

FIG. 10

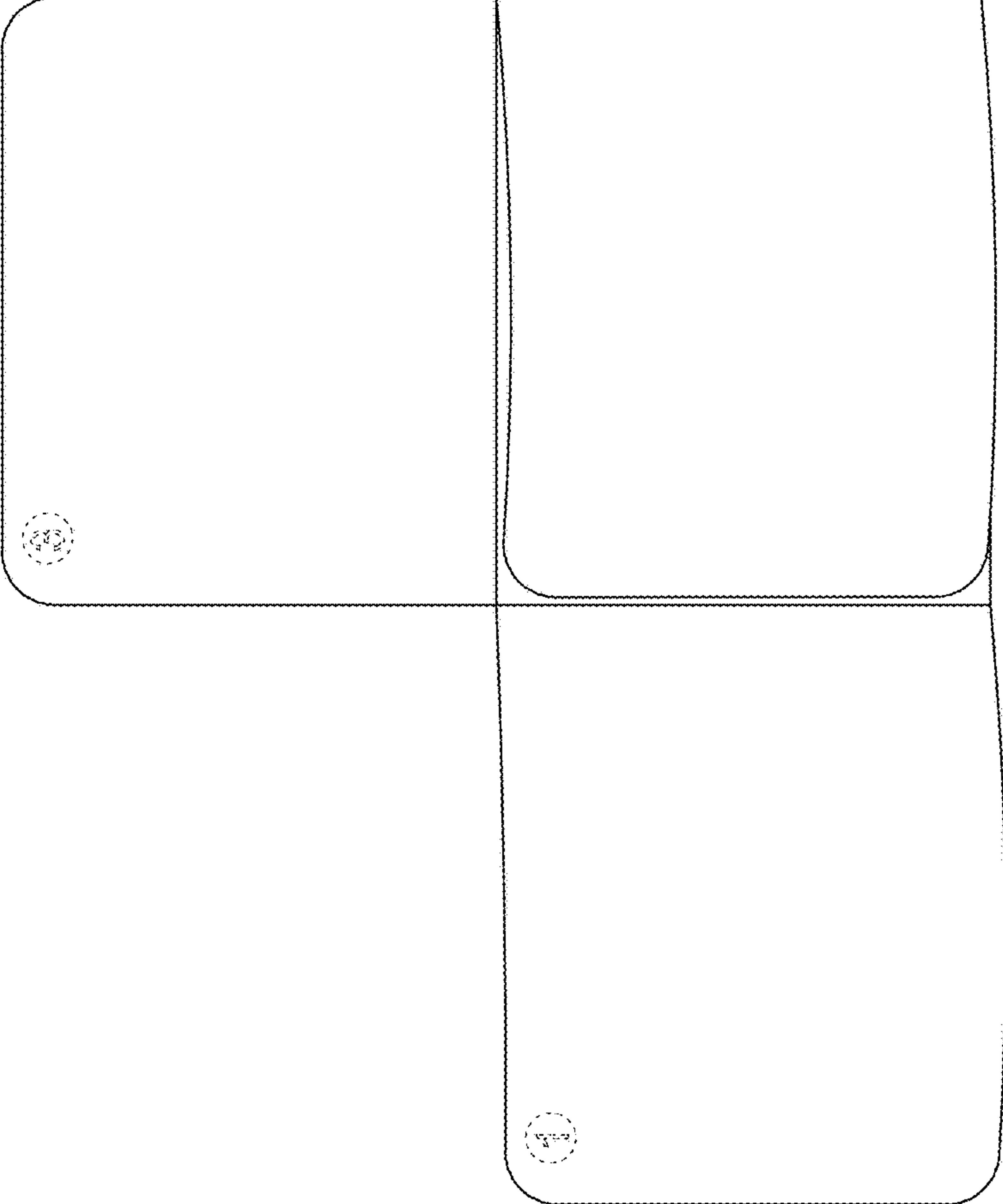

FIG. 11

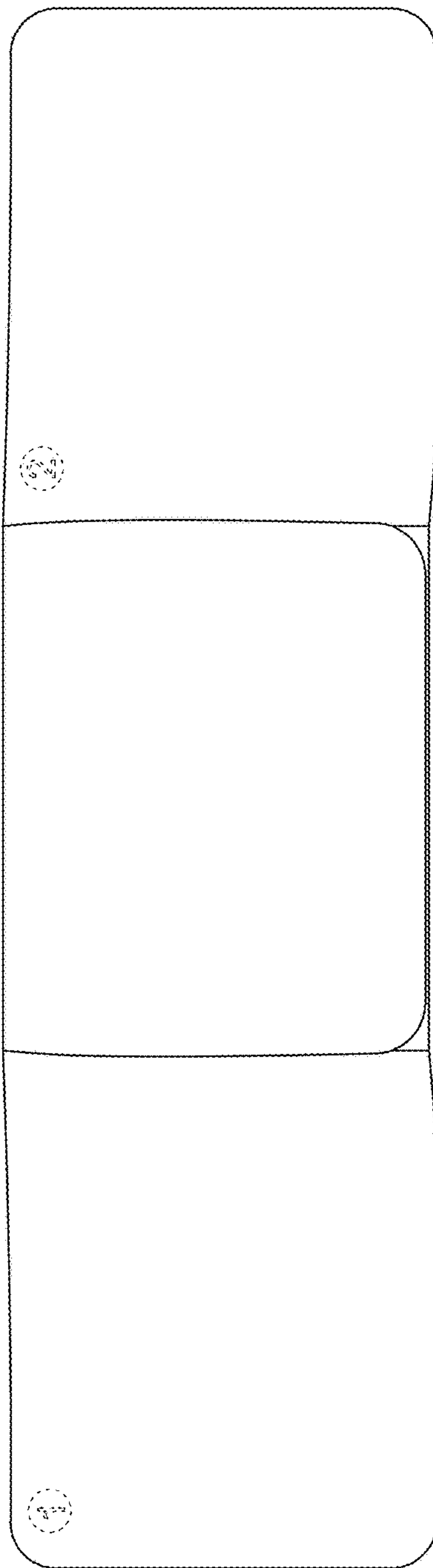

FIG. 12

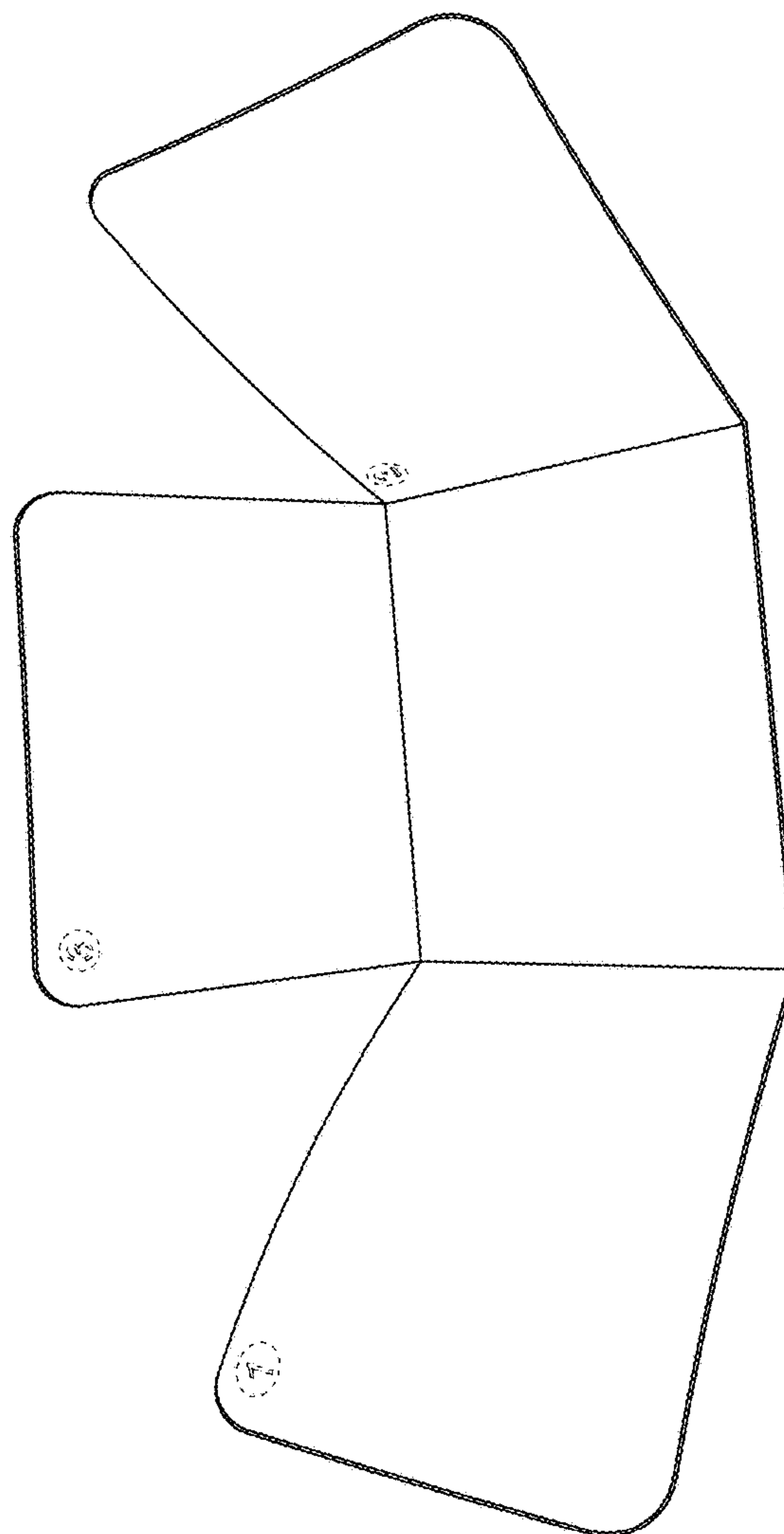

FIG. 13

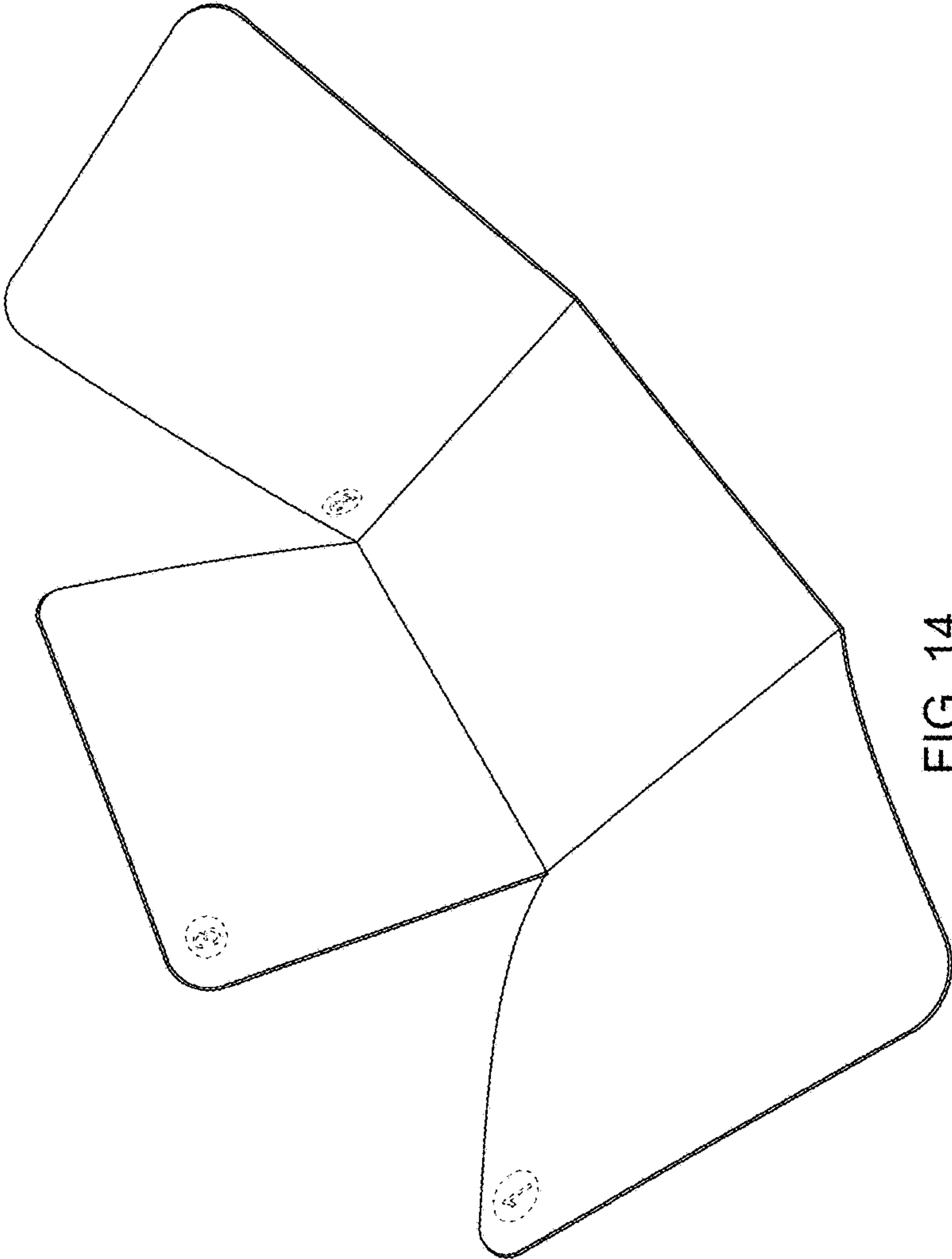

FIG. 14

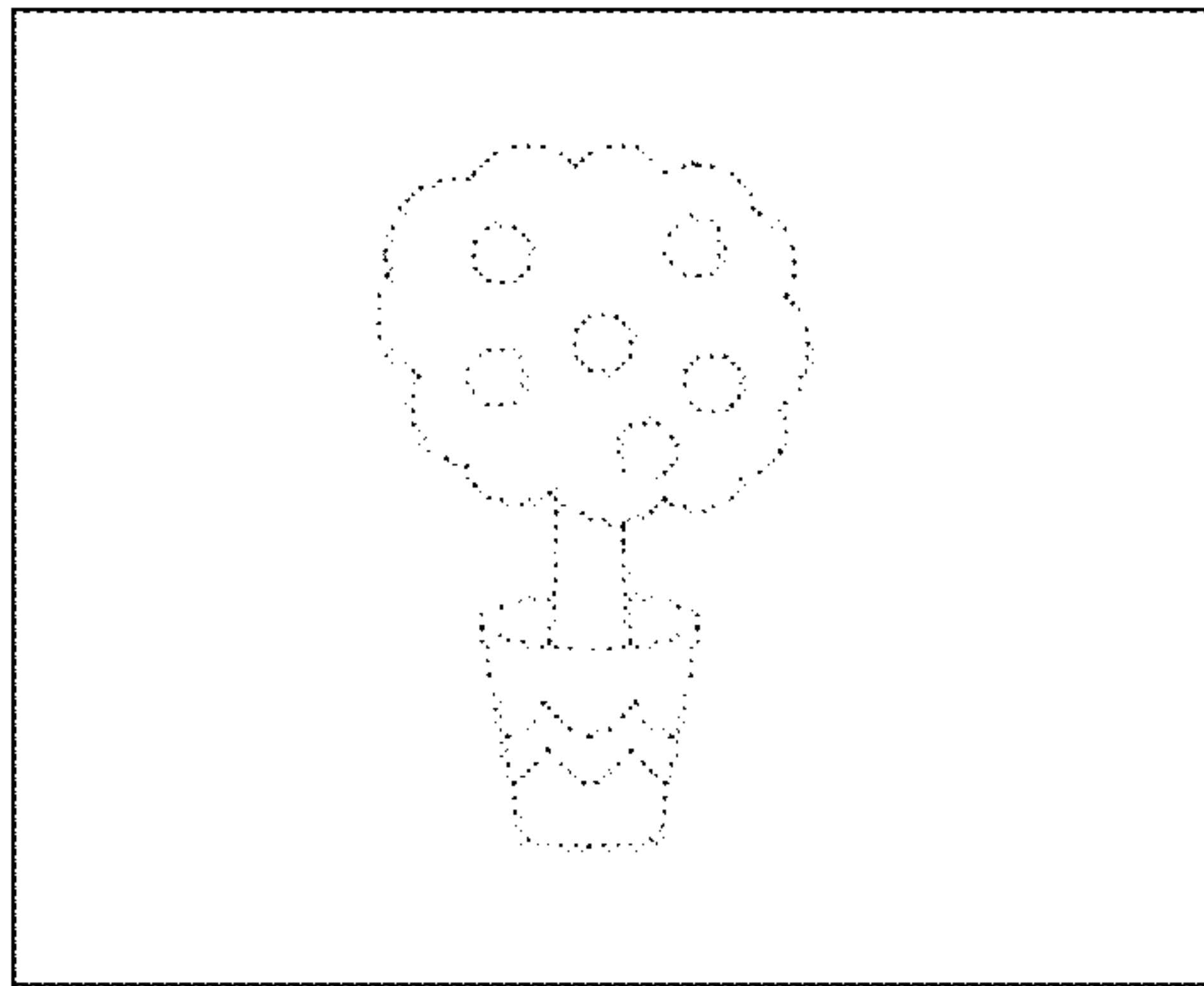

FIG. 15

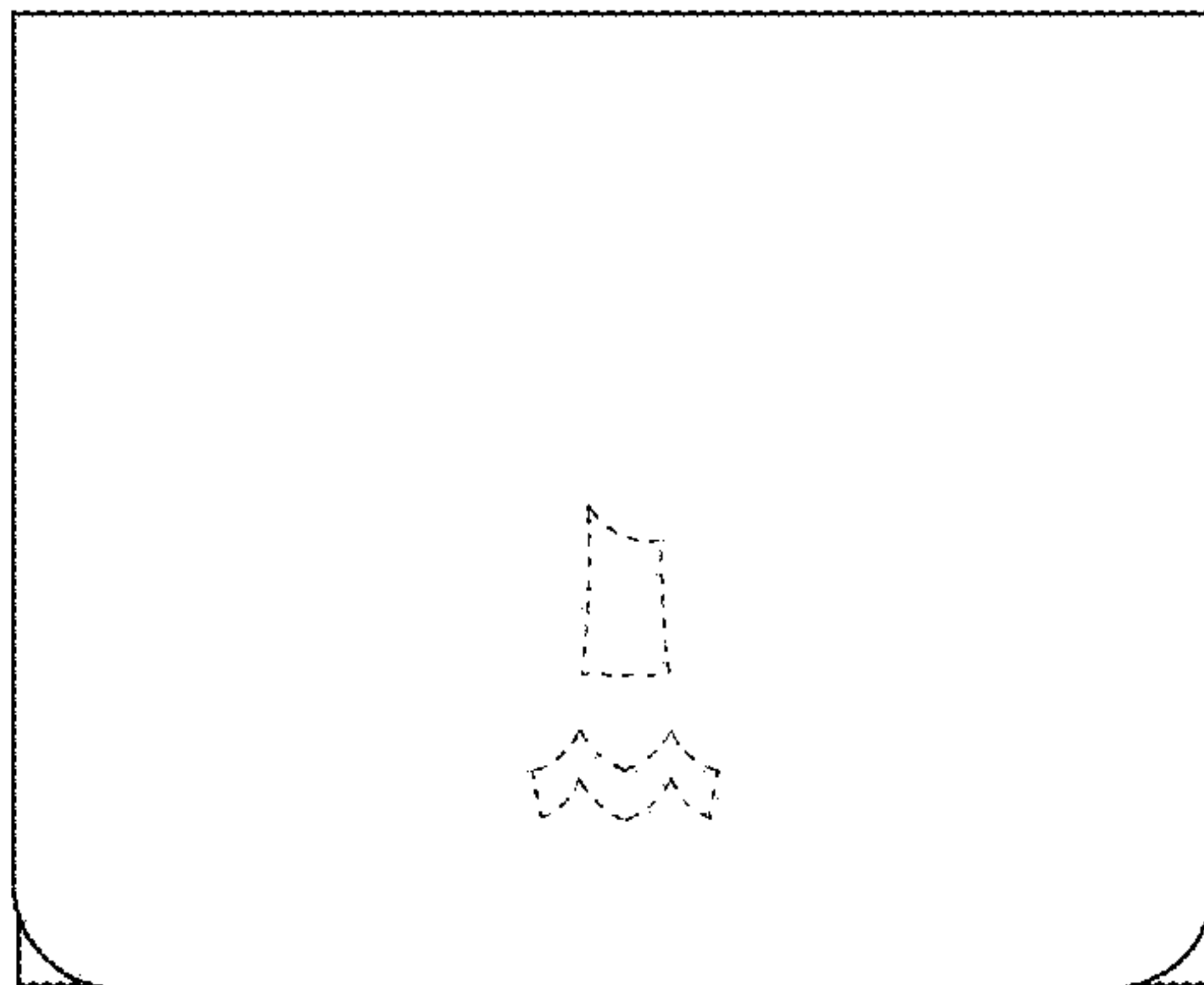

FIG. 16

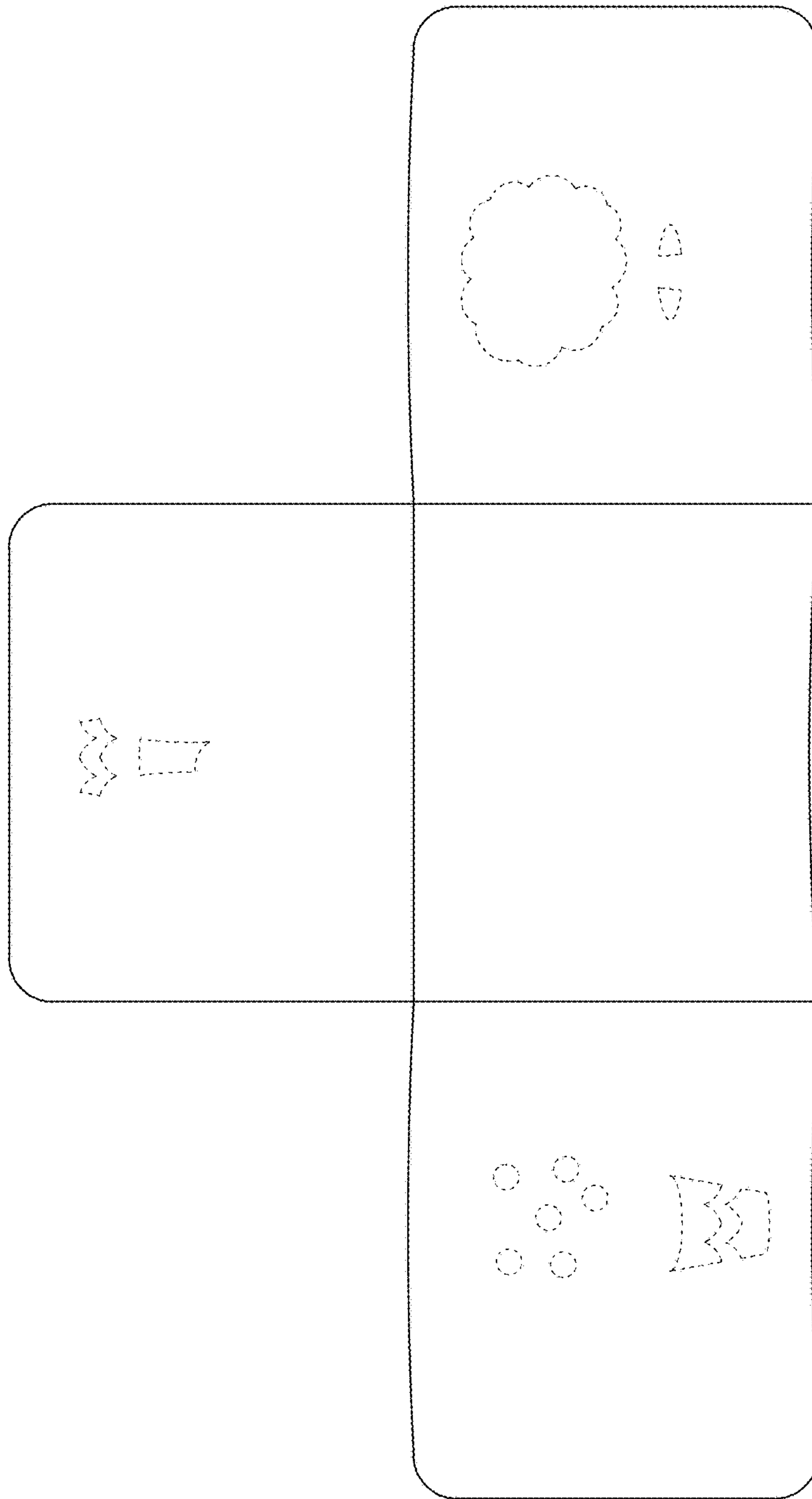

FIG. 17

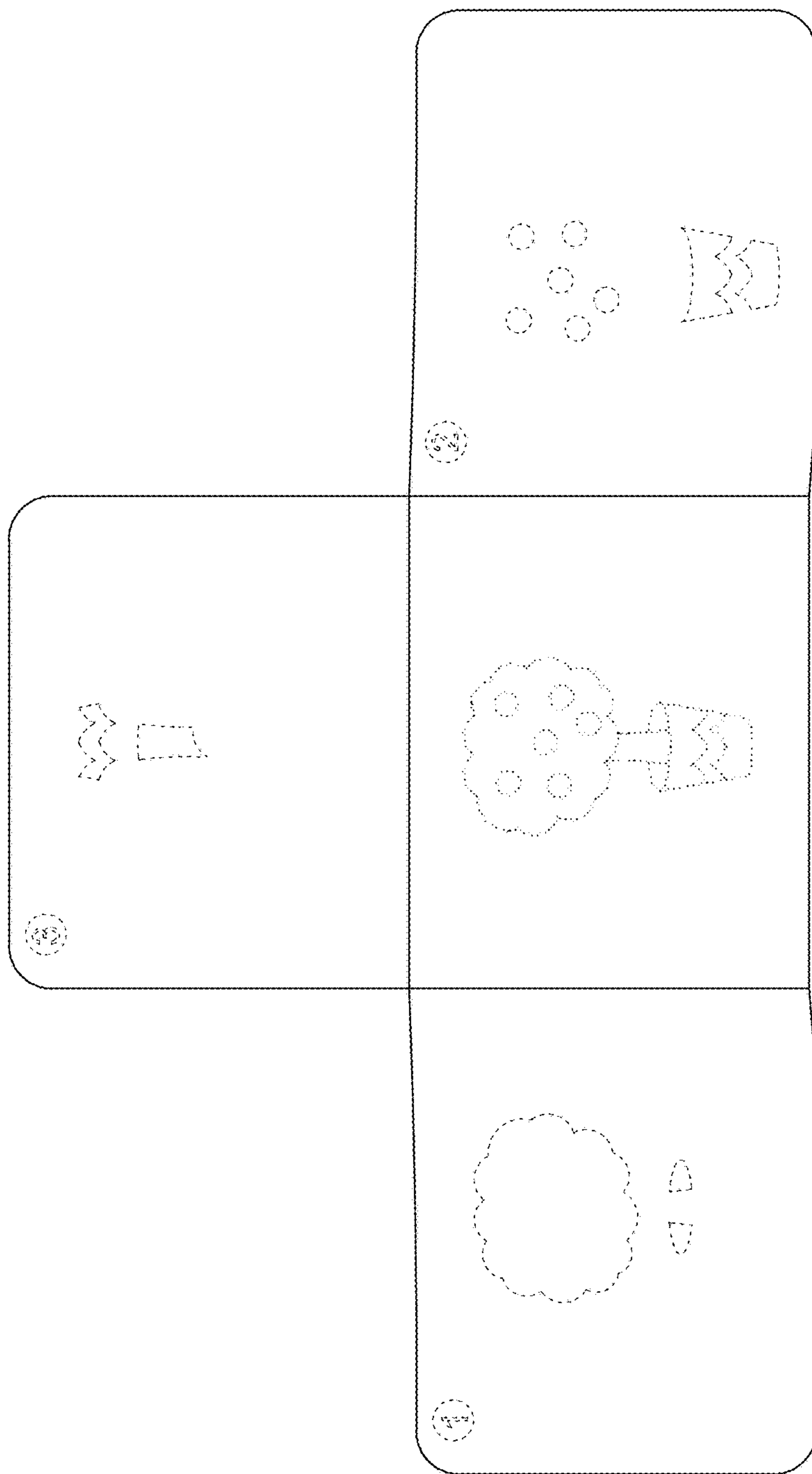

FIG. 18



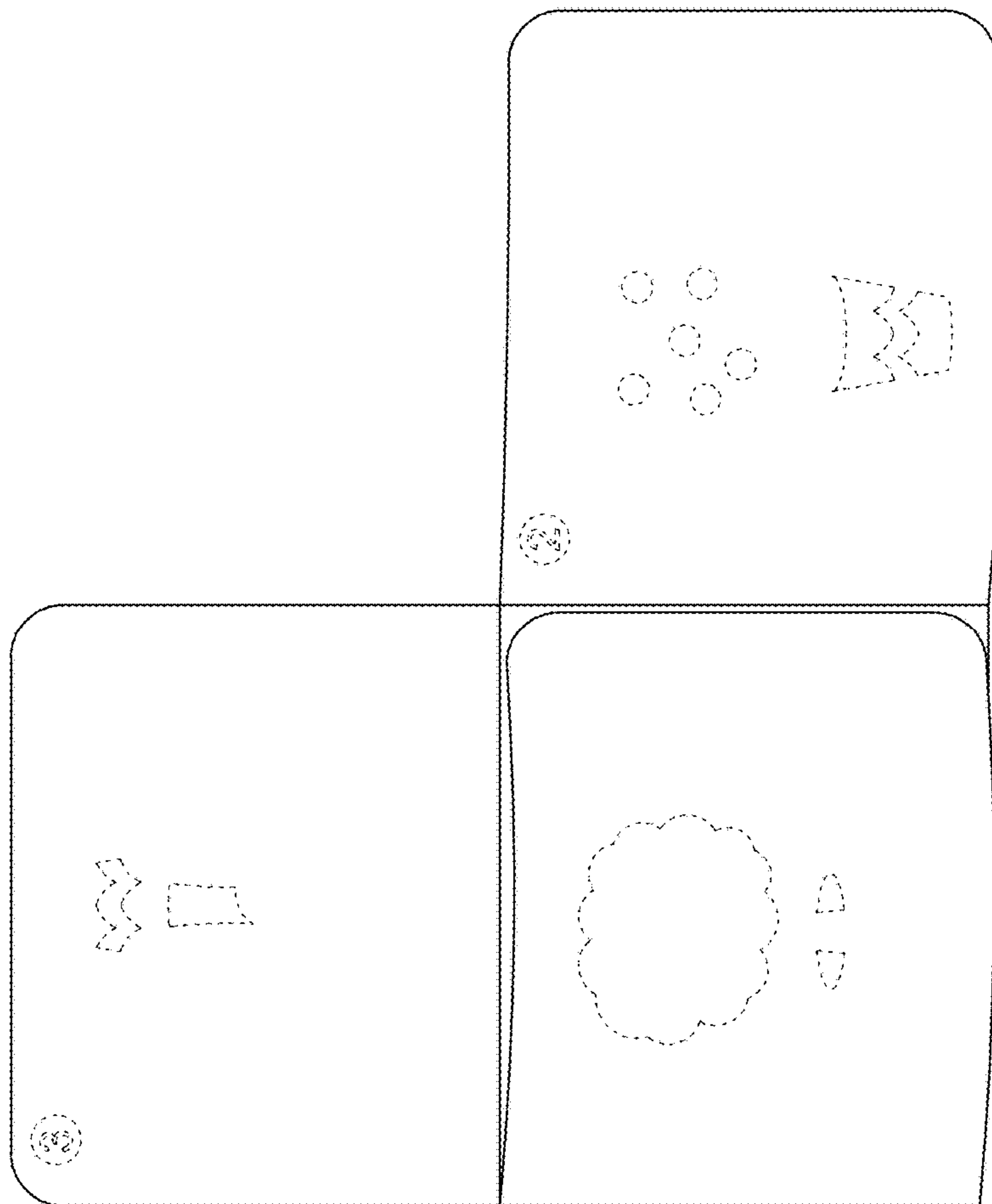

FIG. 19

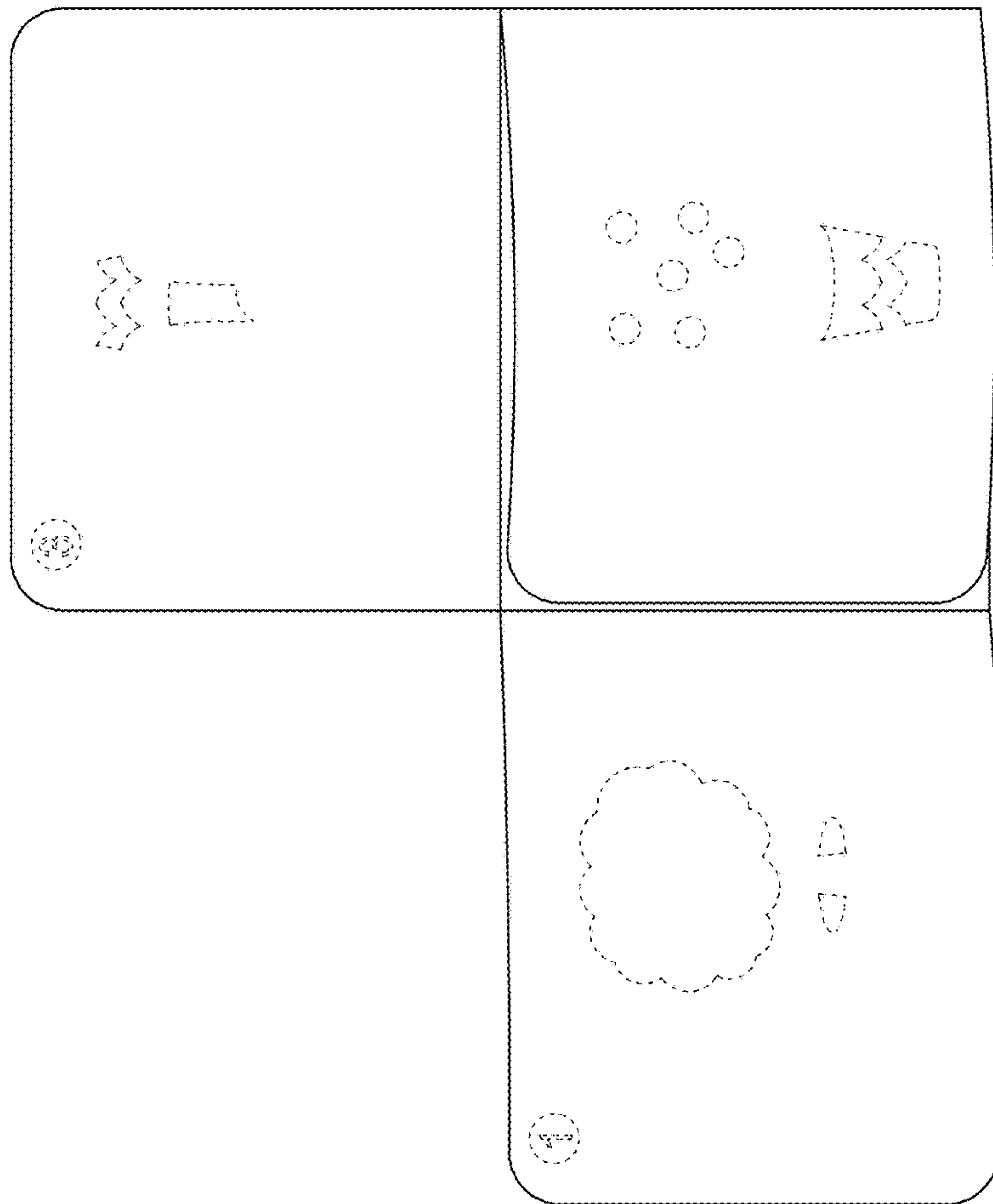

FIG. 20

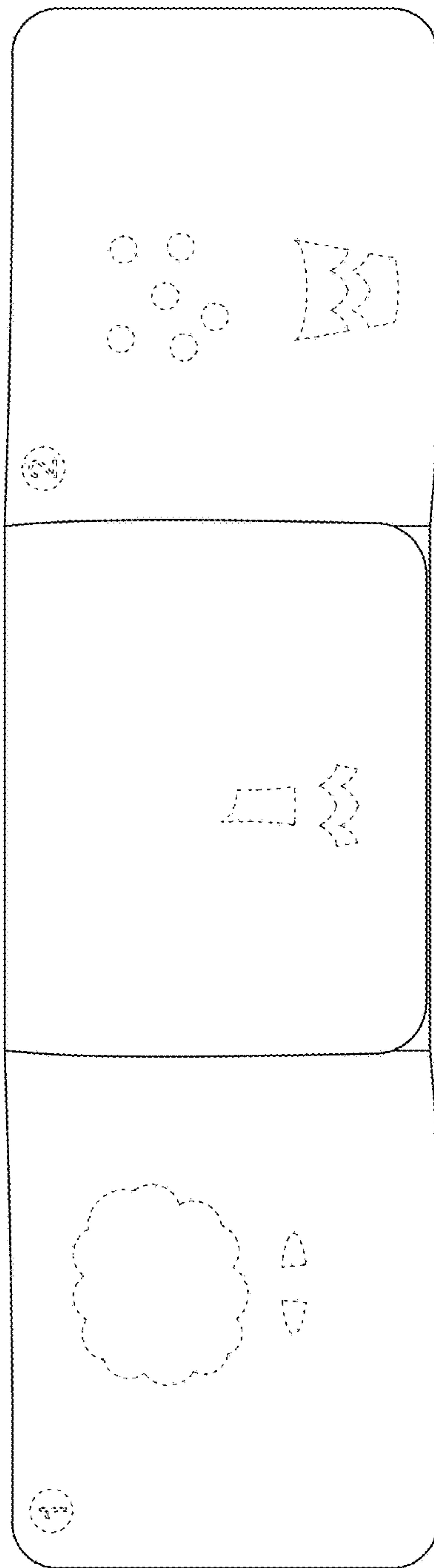

FIG. 21