



US00D868147S

(12) **United States Design Patent**
McGarry et al.

(10) **Patent No.:** **US D868,147 S**

(45) **Date of Patent:** **** Nov. 26, 2019**

(54) **MEDIA SHREDDER**

(71) Applicant: **Staples The Office Superstore, LLC**, Framingham, MA (US)

(72) Inventors: **Rory McGarry**, Jamaica Plain, MA (US); **Albert King**, Quincy, MA (US); **Taehak Kwon**, Brookline, MA (US); **Richard Watson**, Norwell, MA (US); **Mark Matthews**, Scituate, MA (US)

(73) Assignee: **STAPLES THE OFFICE SUPERSTORE, LLC**, Framingham, MA (US)

(**) Term: **15 Years**

(21) Appl. No.: **29/624,595**

(22) Filed: **Nov. 2, 2017**

(51) **LOC (12) Cl.** **18-04**

(52) **U.S. Cl.**
USPC **D18/34.5**

(58) **Field of Classification Search**
USPC D18/34.1, 34.2, 34.3, 34.4, 34.5, 34.6, D18/34.7, 34.8, 34.9; D14/314, 332, D14/348-349, 351, 352
(Continued)

(56) **References Cited**

U.S. PATENT DOCUMENTS

D557,732 S * 12/2007 Ho D18/34.6
D580,480 S * 11/2008 Sued D18/34.5
(Continued)

FOREIGN PATENT DOCUMENTS

CA 178009 * 2/2019
CA 178010 * 2/2019
EM 000206446-0001 * 10/2004

OTHER PUBLICATIONS

Staples. Link: https://www.staples.com/tru-red-8-sheet-micro-cut-personal-shredder-tr-bmc8a/product_24311727. Visited Apr. 15, 2019. TRU RED™ 8-Sheet Micro-Cut Personal Shredder. (Year: 2019).*

(Continued)

Primary Examiner — Susan Moon Lee

Assistant Examiner — Lauren D McVey

(74) *Attorney, Agent, or Firm* — Sheridan Ross P.C.

(57) **CLAIM**

The ornamental design for the media shredder, as shown and described.

DESCRIPTION

FIG. 1 is a perspective view of a first embodiment of a media shredder, showing our new design;
FIG. 2 is a front elevation view thereof;
FIG. 3 is a rear elevation view thereof;
FIG. 4 is a right side elevation view thereof;
FIG. 5 is a left side elevation view thereof;
FIG. 6 is a top plan view thereof;
FIG. 7 is a bottom plan view thereof;
FIG. 8 is a perspective view of a second embodiment of a media shredder, showing our new design;
FIG. 9 is a front elevation view of the media shredder of FIG. 8;
FIG. 10 is a rear elevation view of the media shredder of FIG. 8;
FIG. 11 is a right side elevation view of the media shredder of FIG. 8;
FIG. 12 is a left side elevation view of the media shredder of FIG. 8;
FIG. 13 is a top plan view of the media shredder of FIG. 8;
FIG. 14 is a bottom plan view of the media shredder of FIG. 8;
FIG. 15 is a perspective view of a third embodiment of a media shredder, showing our new design;
FIG. 16 is a front elevation view of the media shredder of FIG. 15;
FIG. 17 is a rear elevation view of the media shredder of FIG. 15;
FIG. 18 is a right side elevation view of the media shredder of FIG. 15;
FIG. 19 is a left side elevation view of the media shredder of FIG. 15;
FIG. 20 is a top plan view of the media shredder of FIG. 15;
and,

(Continued)

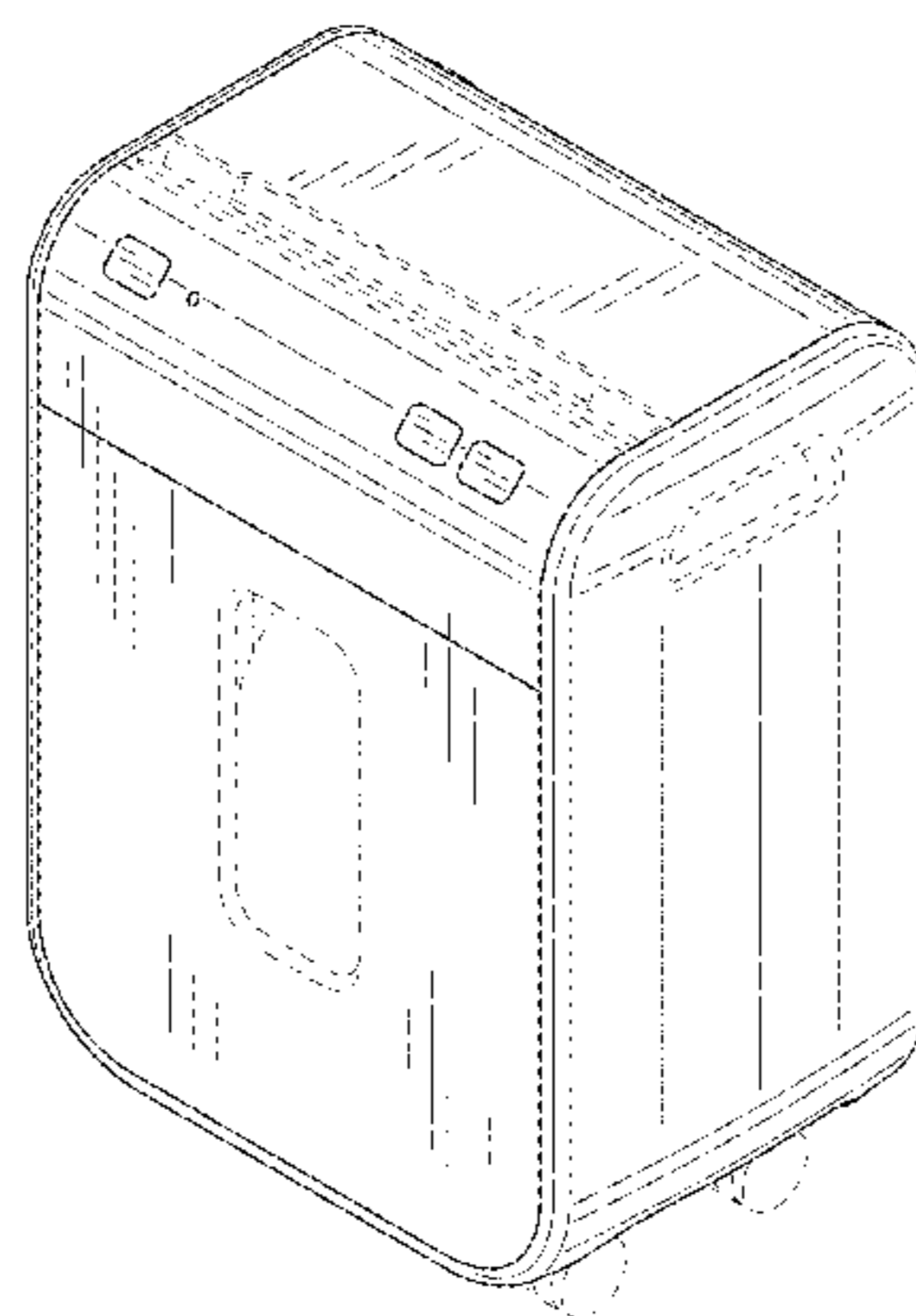
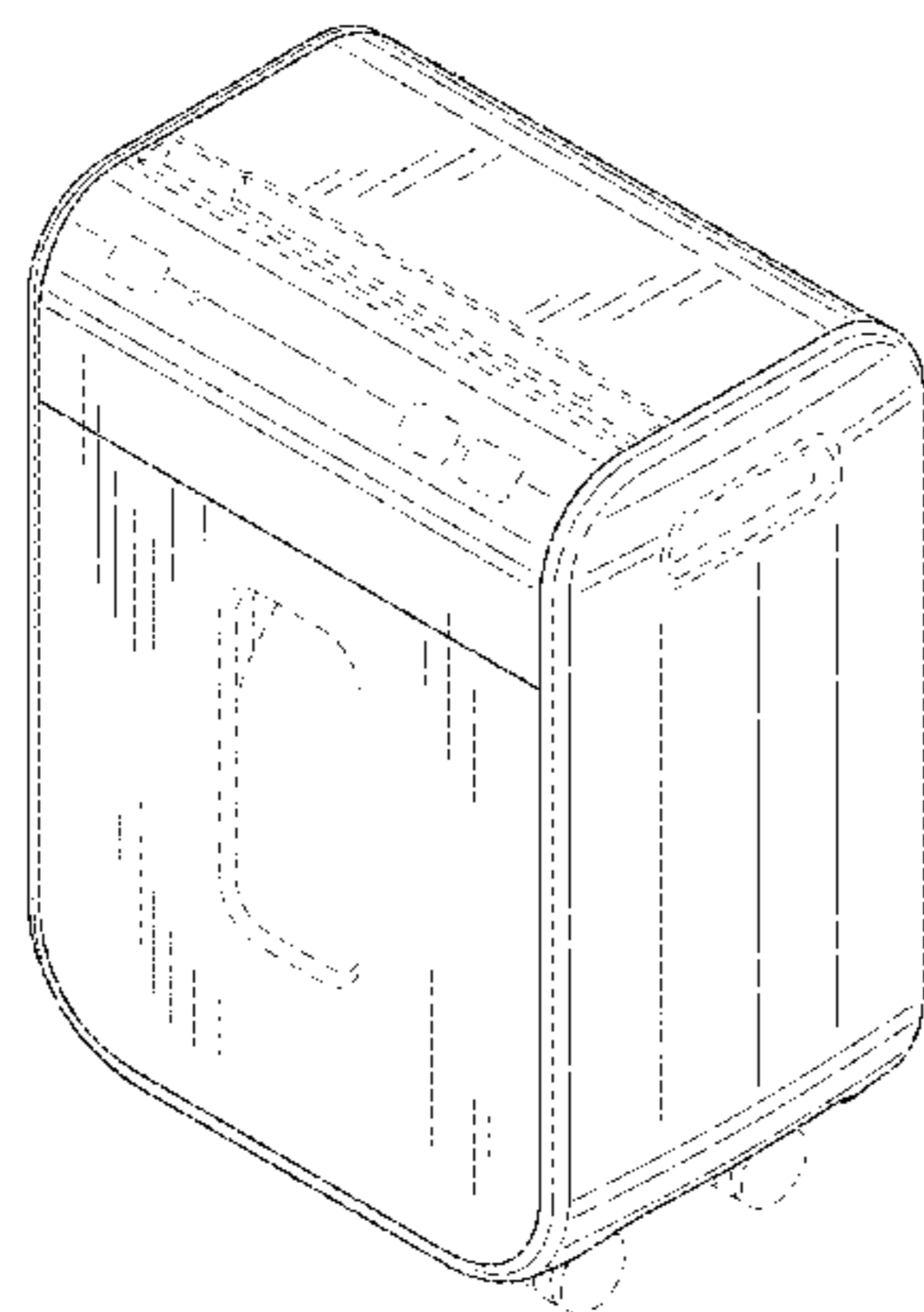

FIG. 21 is a bottom plan view of the media shredder of FIG. 15.

The broken lines immediately adjacent to the shaded areas depict the bounds of the claimed design, while all other broken lines are directed to environment. The broken lines form no part of the claimed design.

1 Claim, 21 Drawing Sheets

(58) Field of Classification Search

CPC B02C 18/00; B02C 18/0007; B02C 2018/164; B02C 2018/168; B02C 2018/0015

See application file for complete search history.

(56) References Cited

U.S. PATENT DOCUMENTS

D598,528 S * 8/2009 Choi D23/359
D611,527 S * 3/2010 Sued D18/34.5

D679,320 S * 4/2013 Whitson D18/34.5
D694,813 S * 12/2013 Choi D18/34.5
D705,860 S * 5/2014 Zhou D18/34.5
D715,354 S * 10/2014 Bell D18/34.5
D748,192 S * 1/2016 Weinberg D18/34.5
9,480,989 B1 * 11/2016 Chang B02C 18/22
D835,713 S * 12/2018 Xu D18/34.6
2008/0054110 A1 * 3/2008 Wang B02C 18/0007
241/100
2014/0061347 A1 * 3/2014 Chang B02C 18/0007
241/282.1

OTHER PUBLICATIONS

Staples. Link: https://www.staples.com/tru-red-24-sheet-cross-cut-commercial-shredder-tr-bxc243a/product_24311726. Visited Apr. 15, 2019. TRU RED™ 24-Sheet Cross-Cut Commercial Shredder. (Year: 2019).*

* cited by examiner

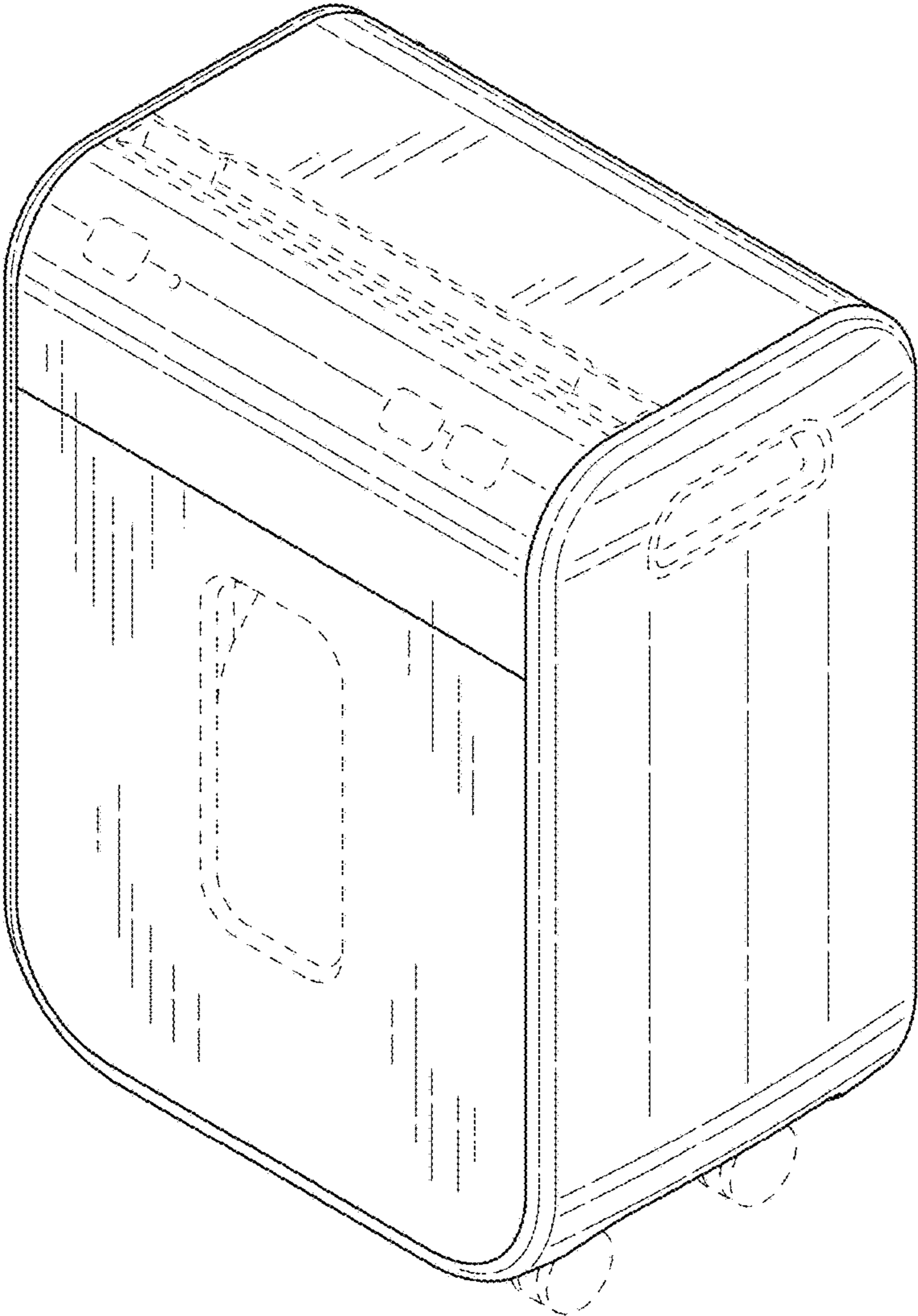

FIG.1

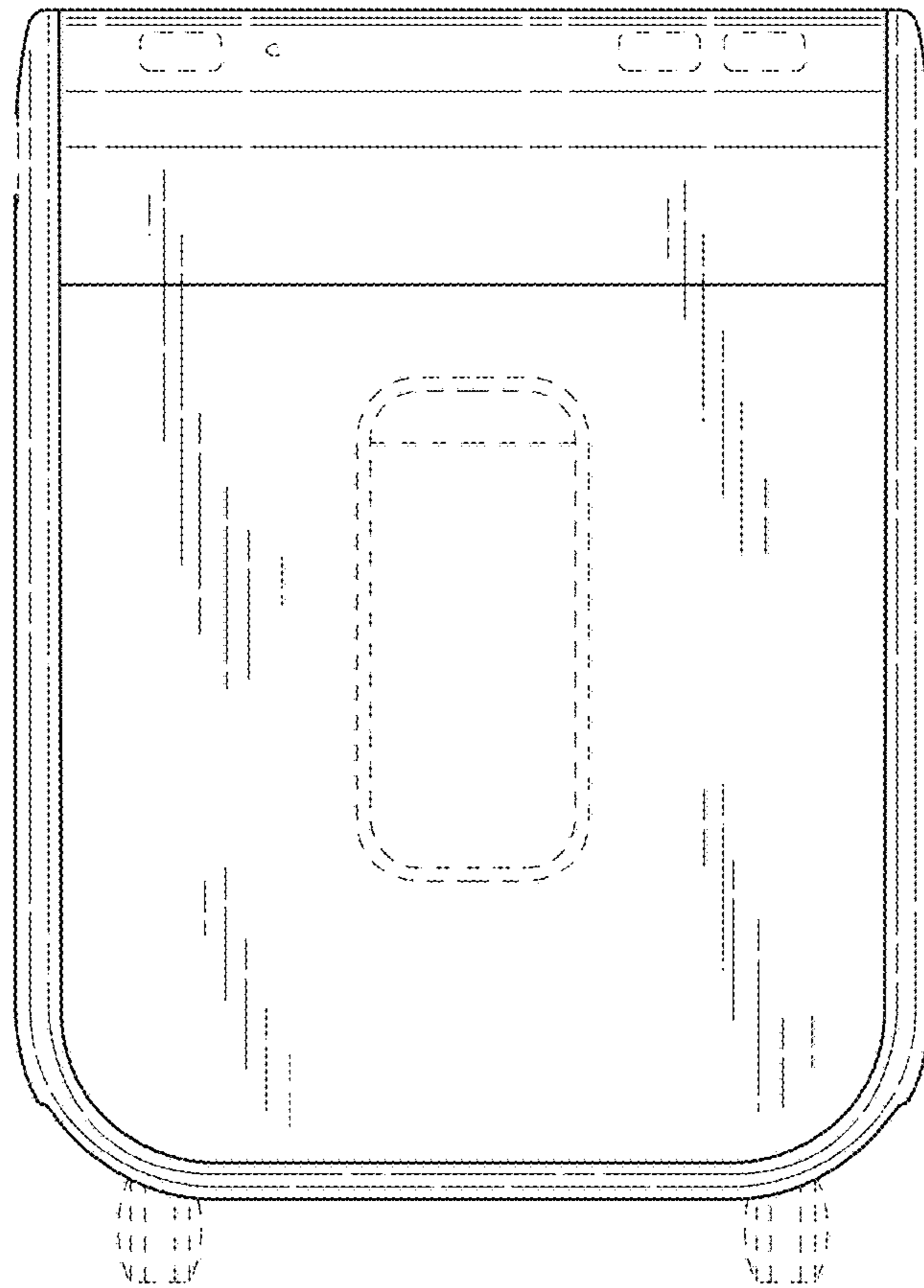

FIG.2

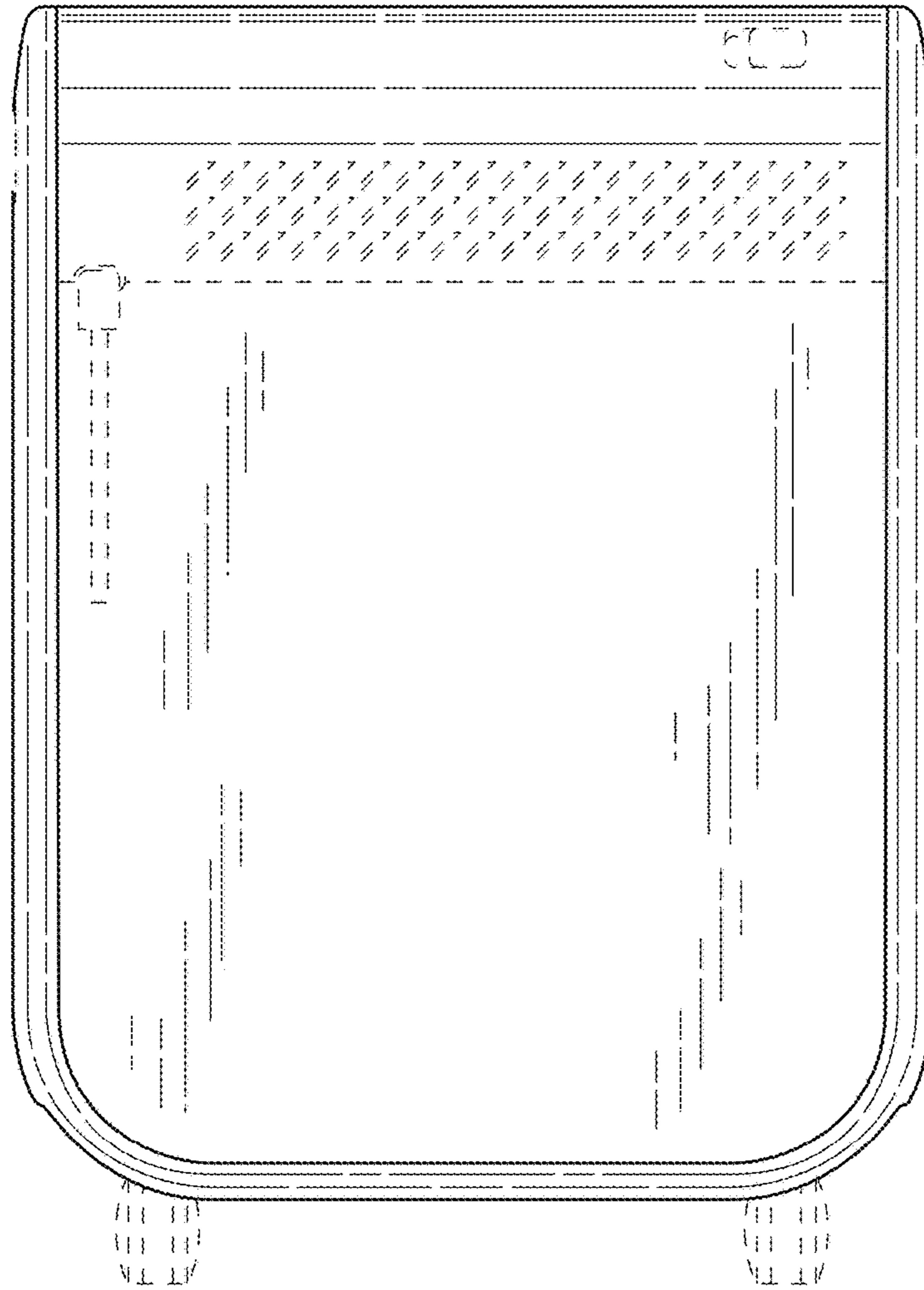

FIG.3

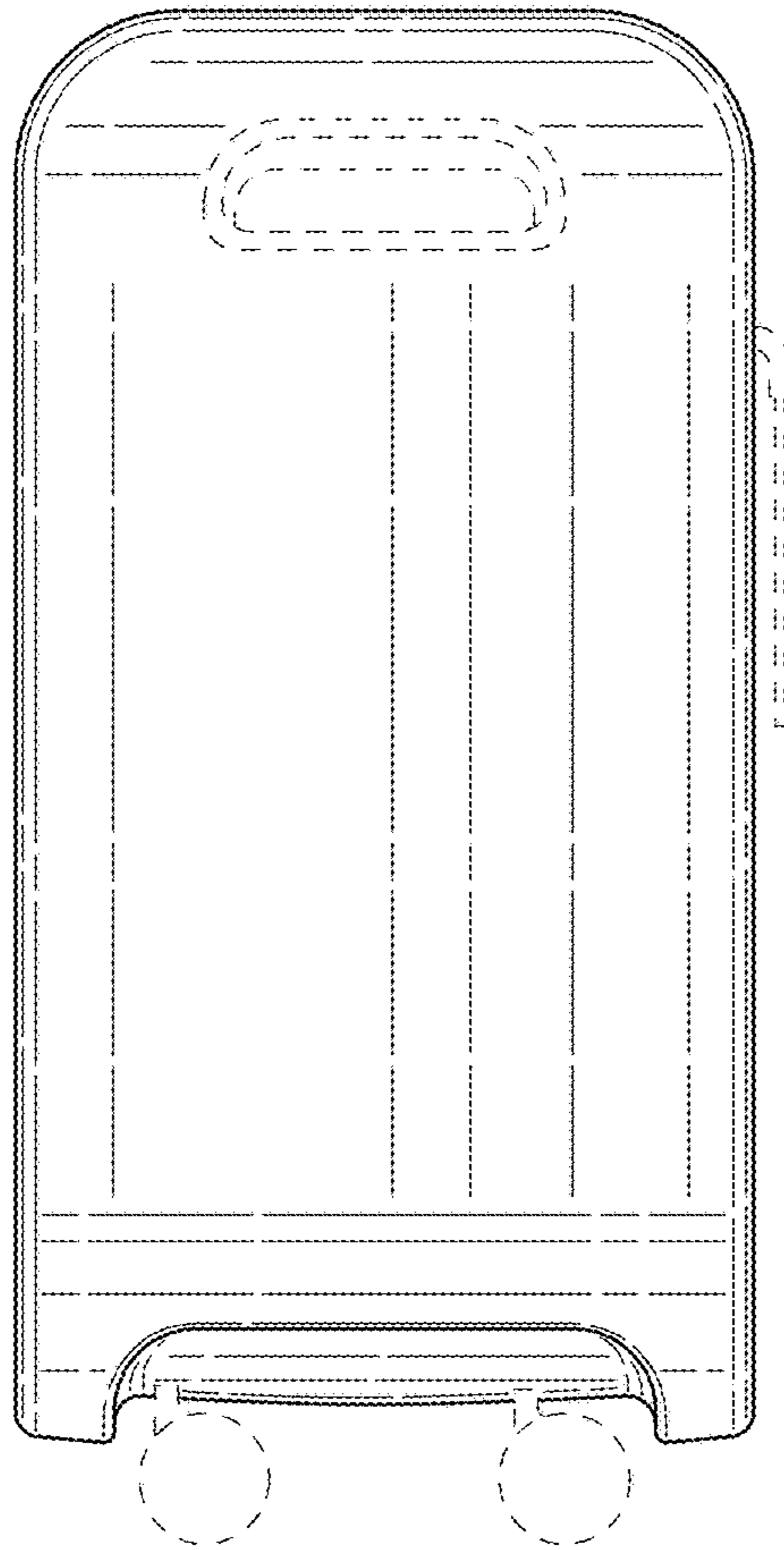

FIG.4

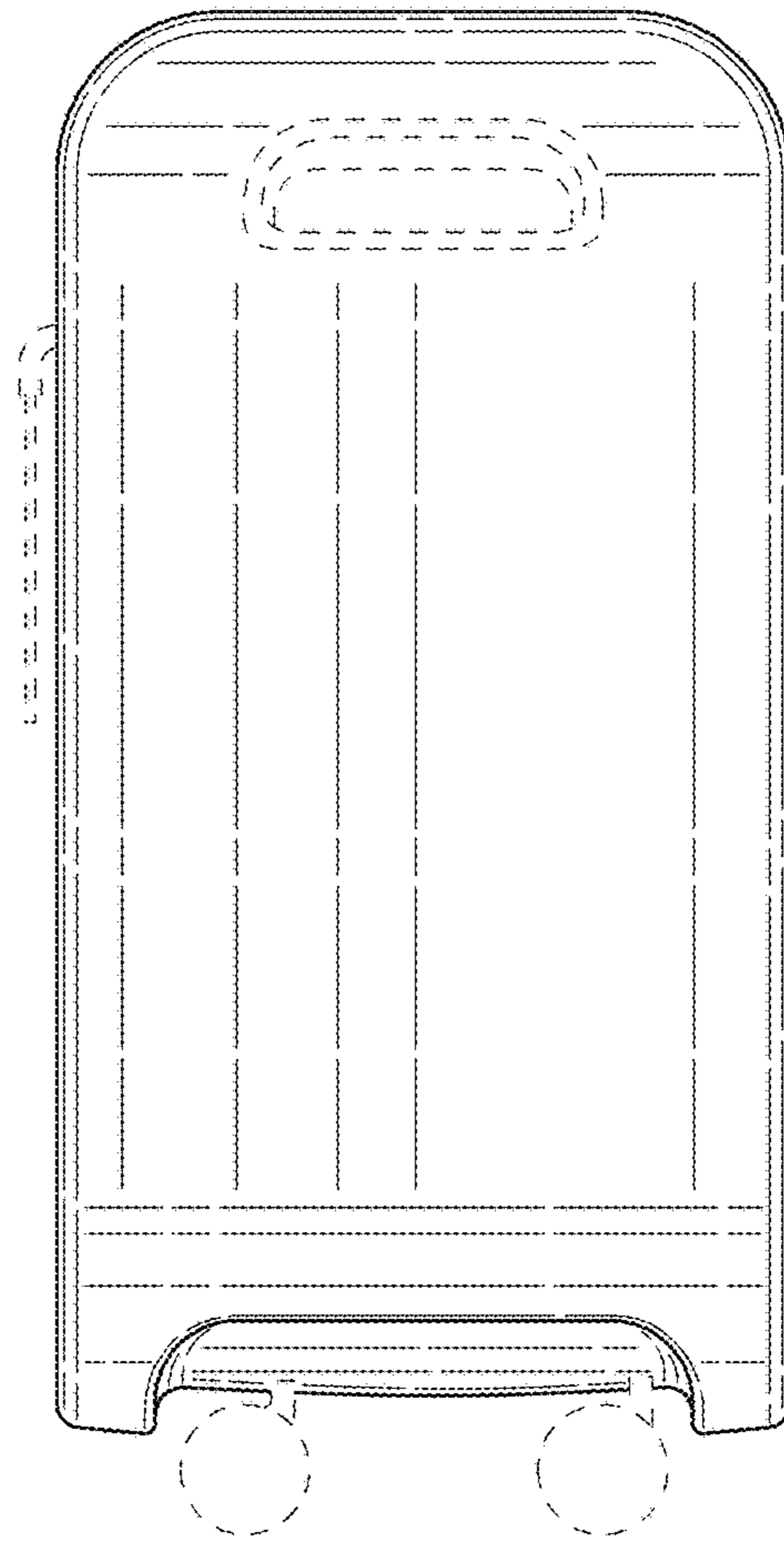

FIG. 5

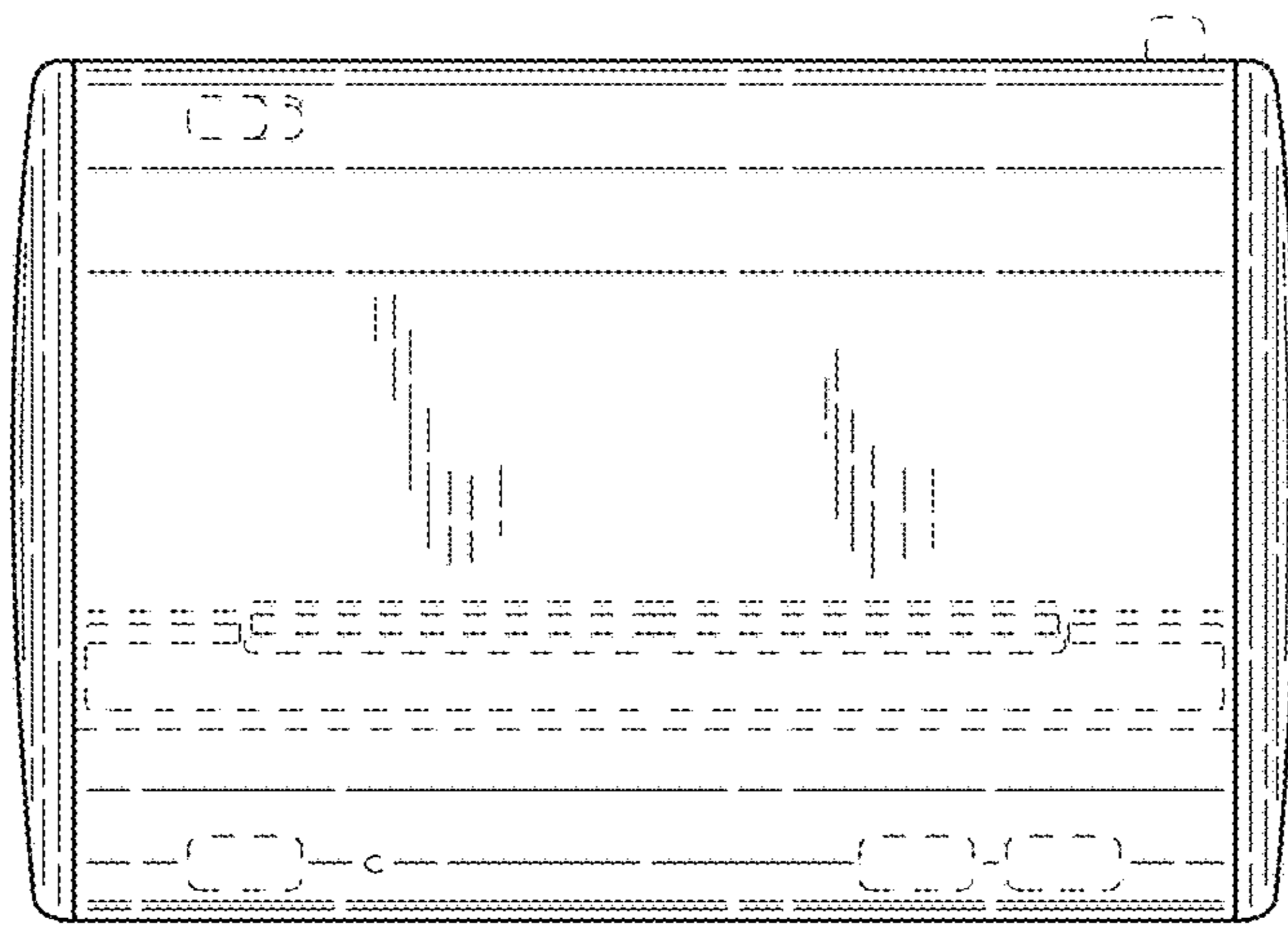

FIG.6

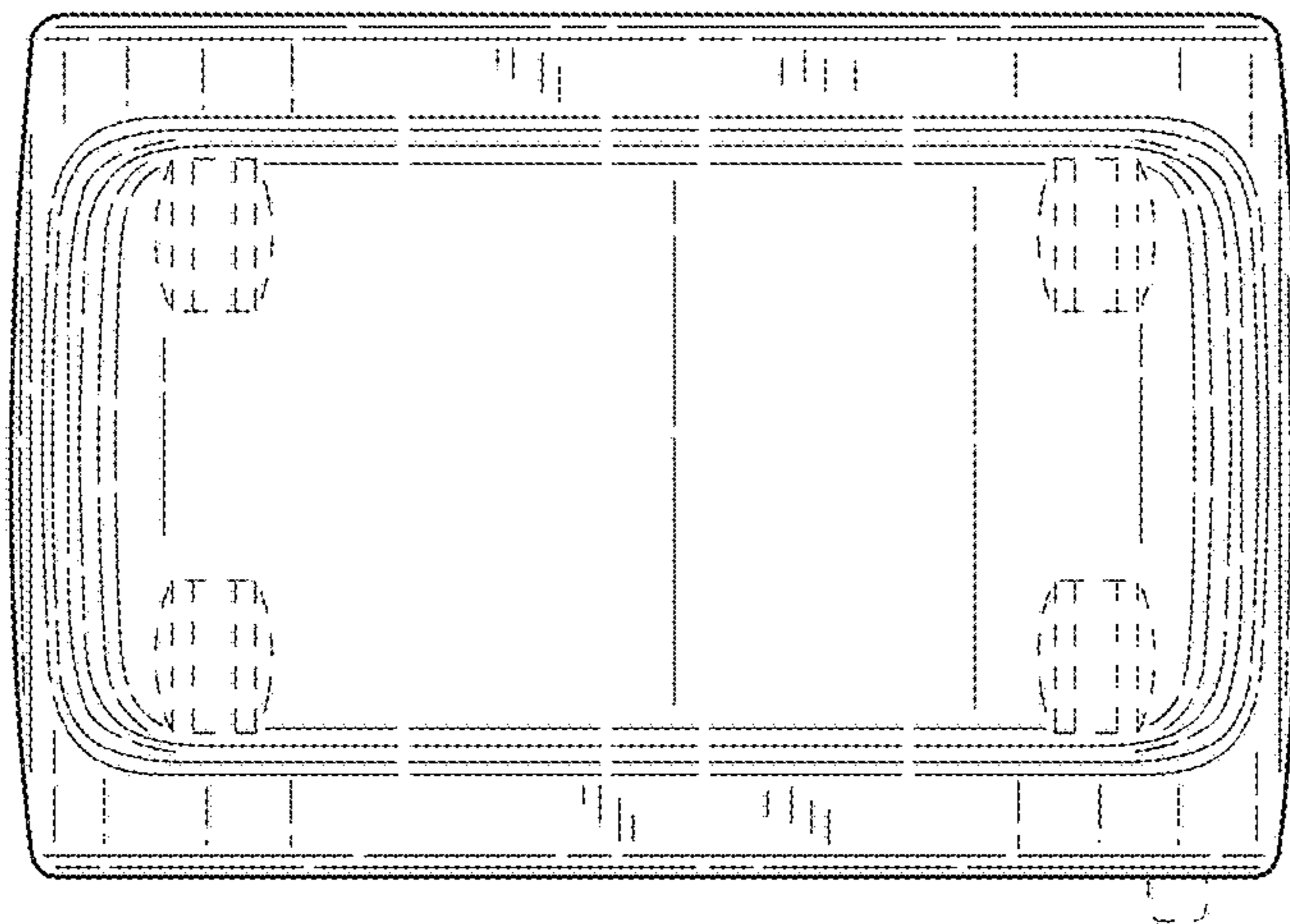

FIG.7

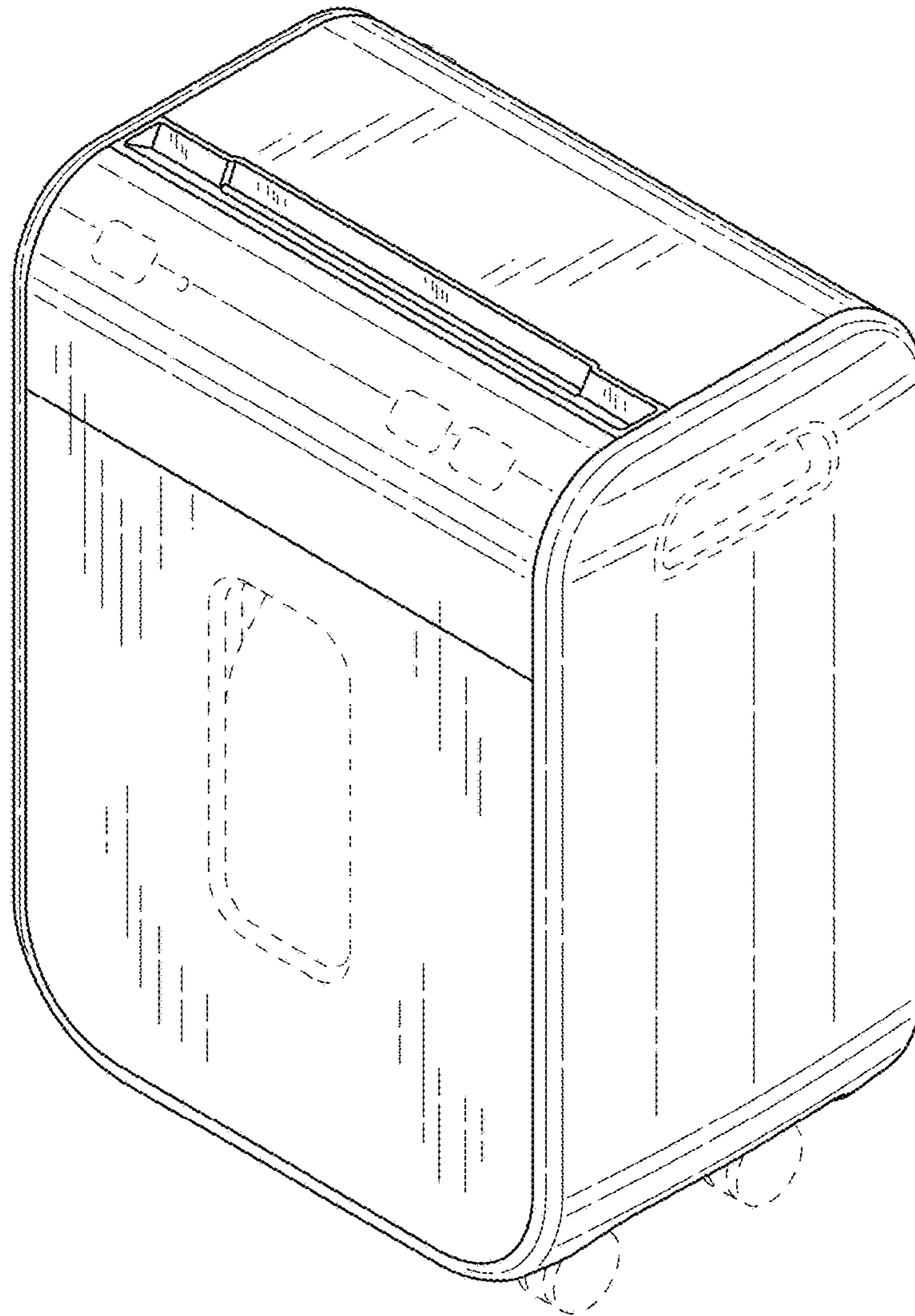

FIG.8

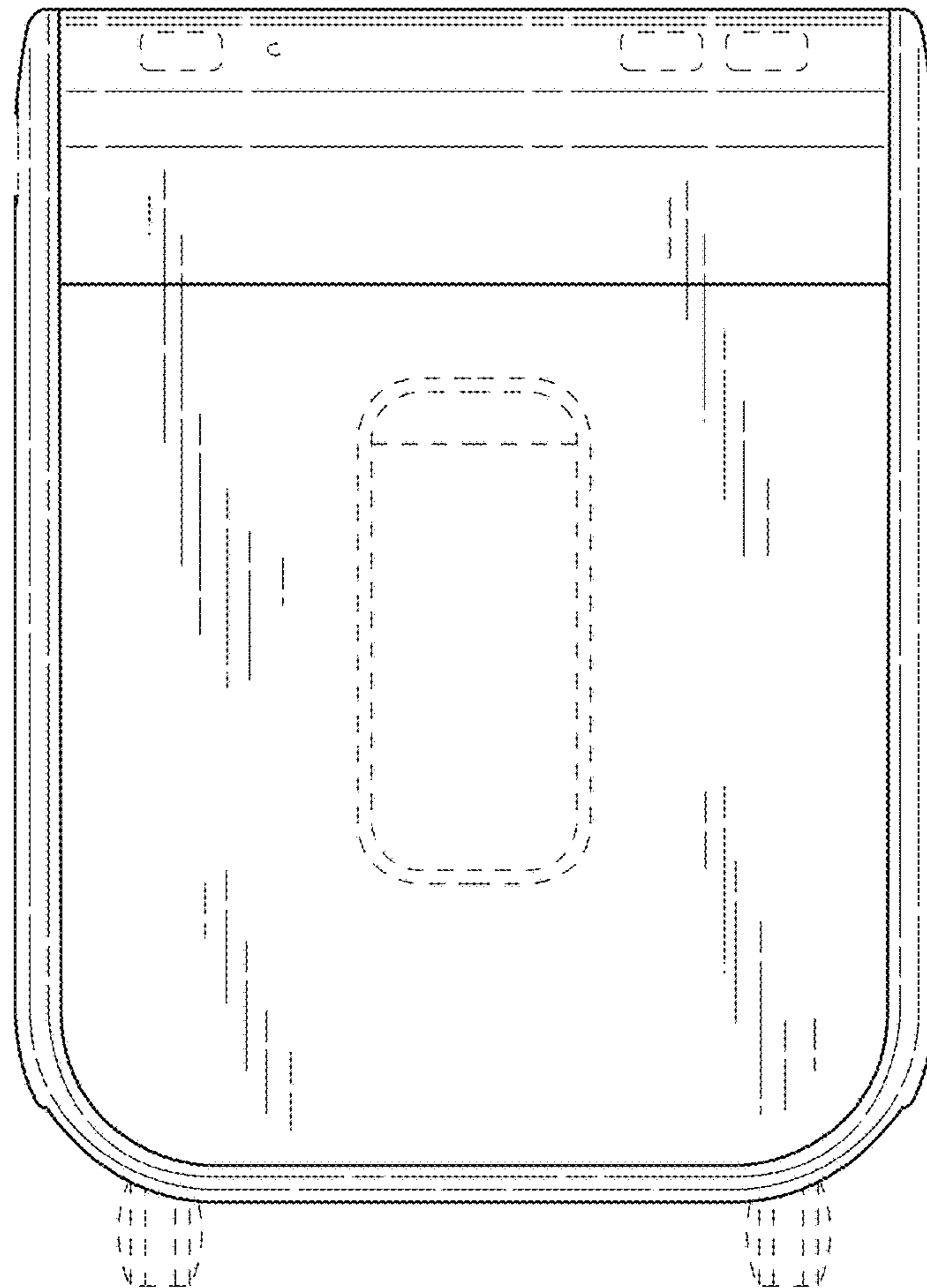

FIG.9

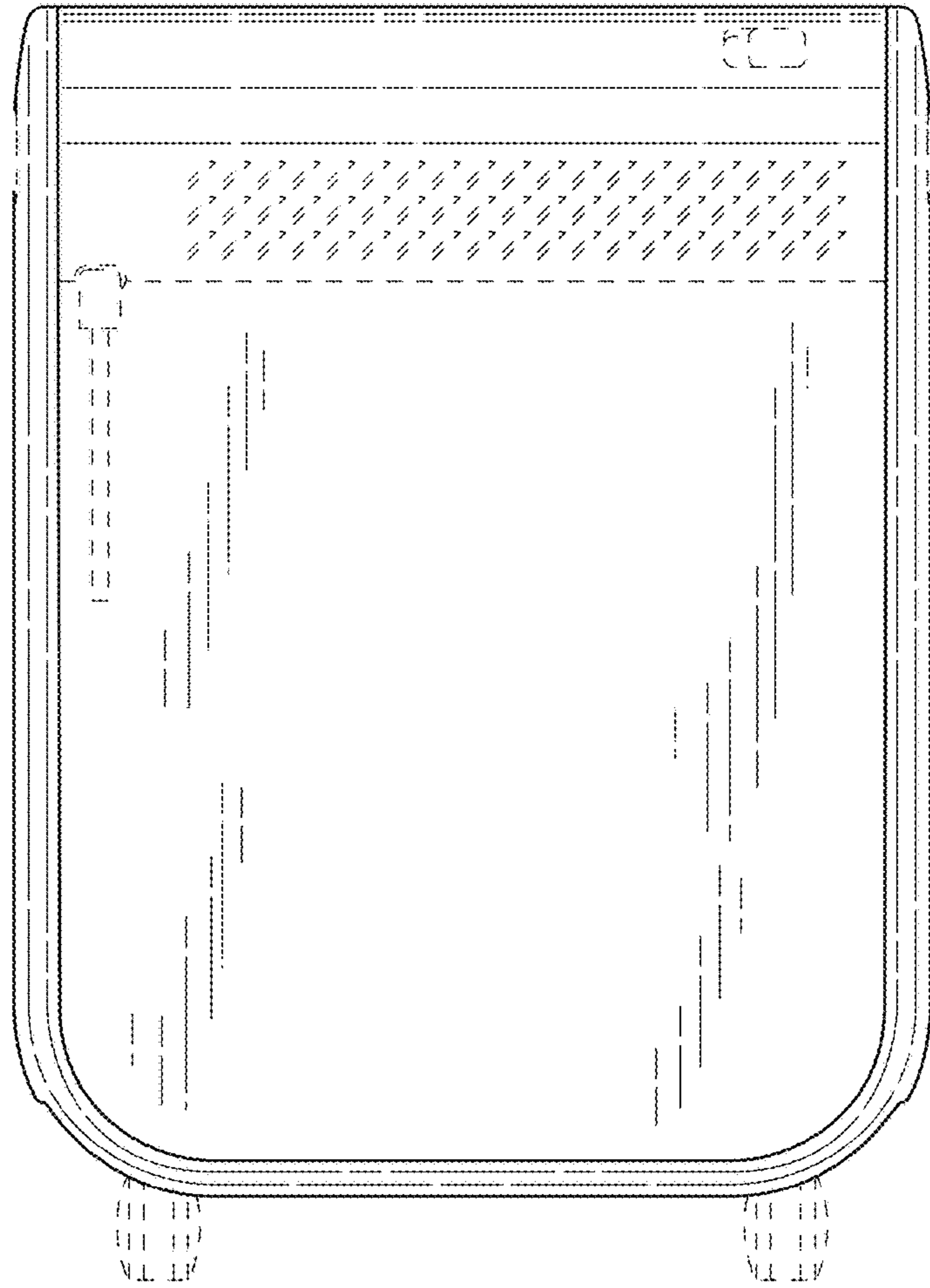

FIG.10

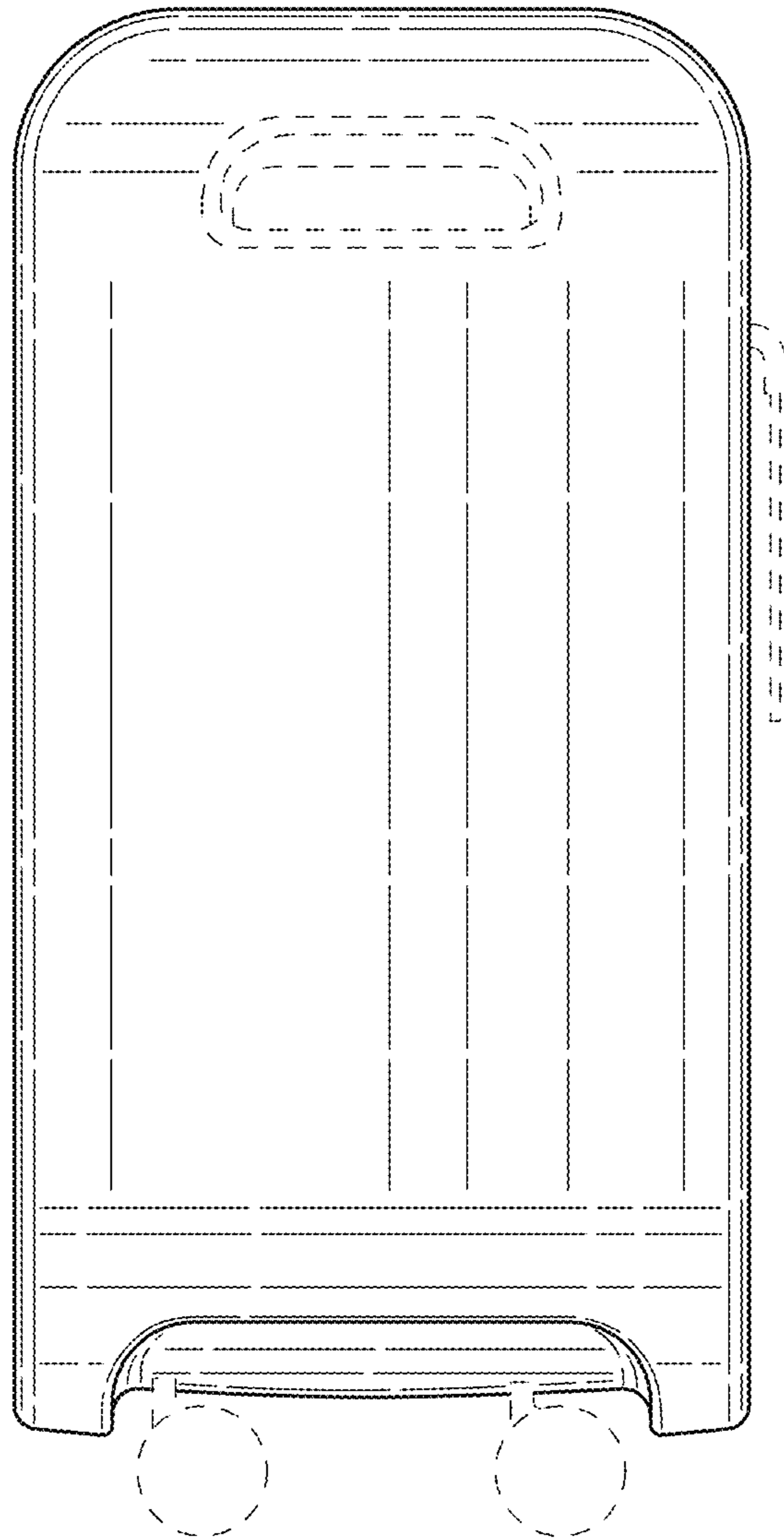

FIG.11

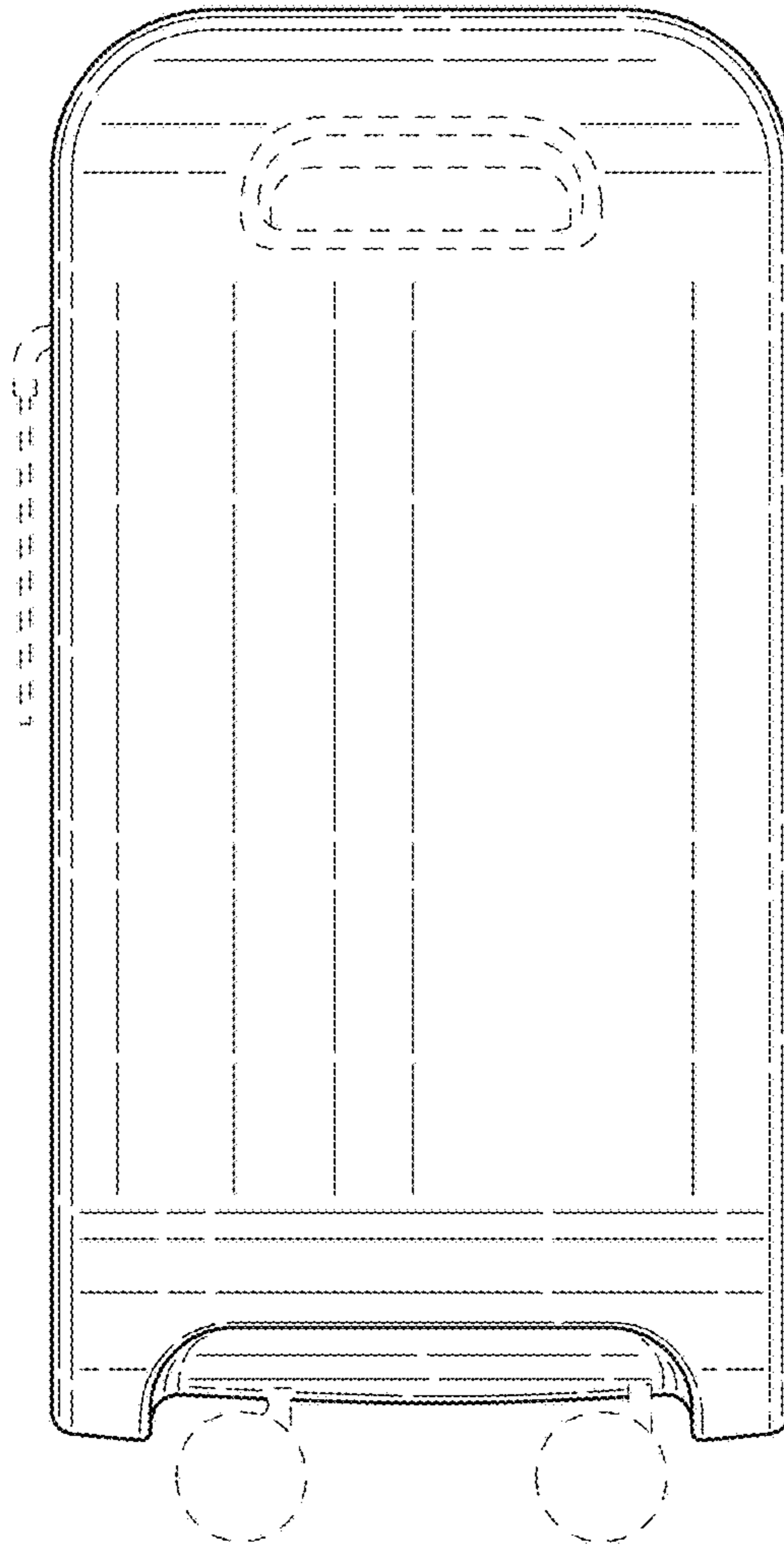

FIG. 12

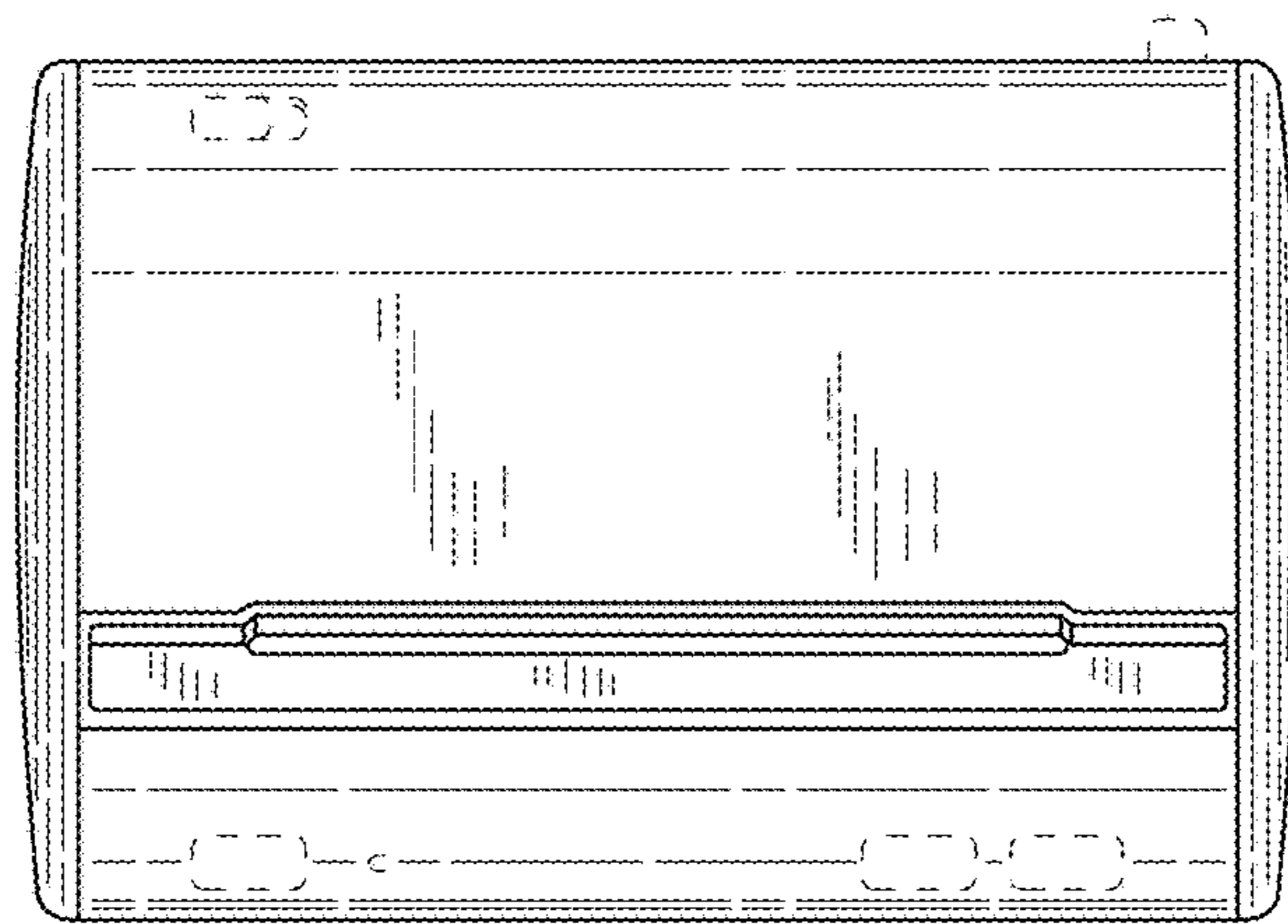

FIG. 13

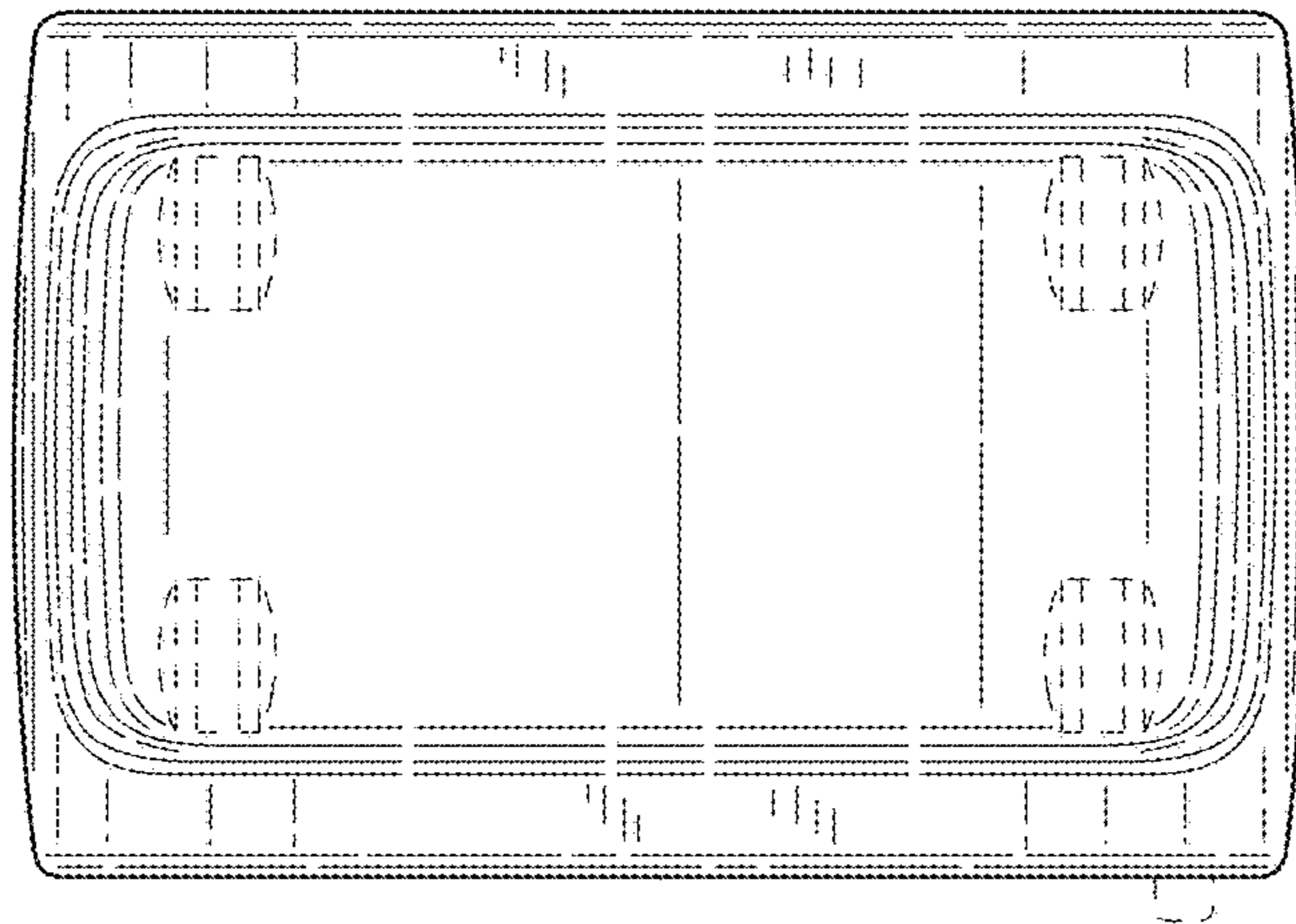

FIG. 14

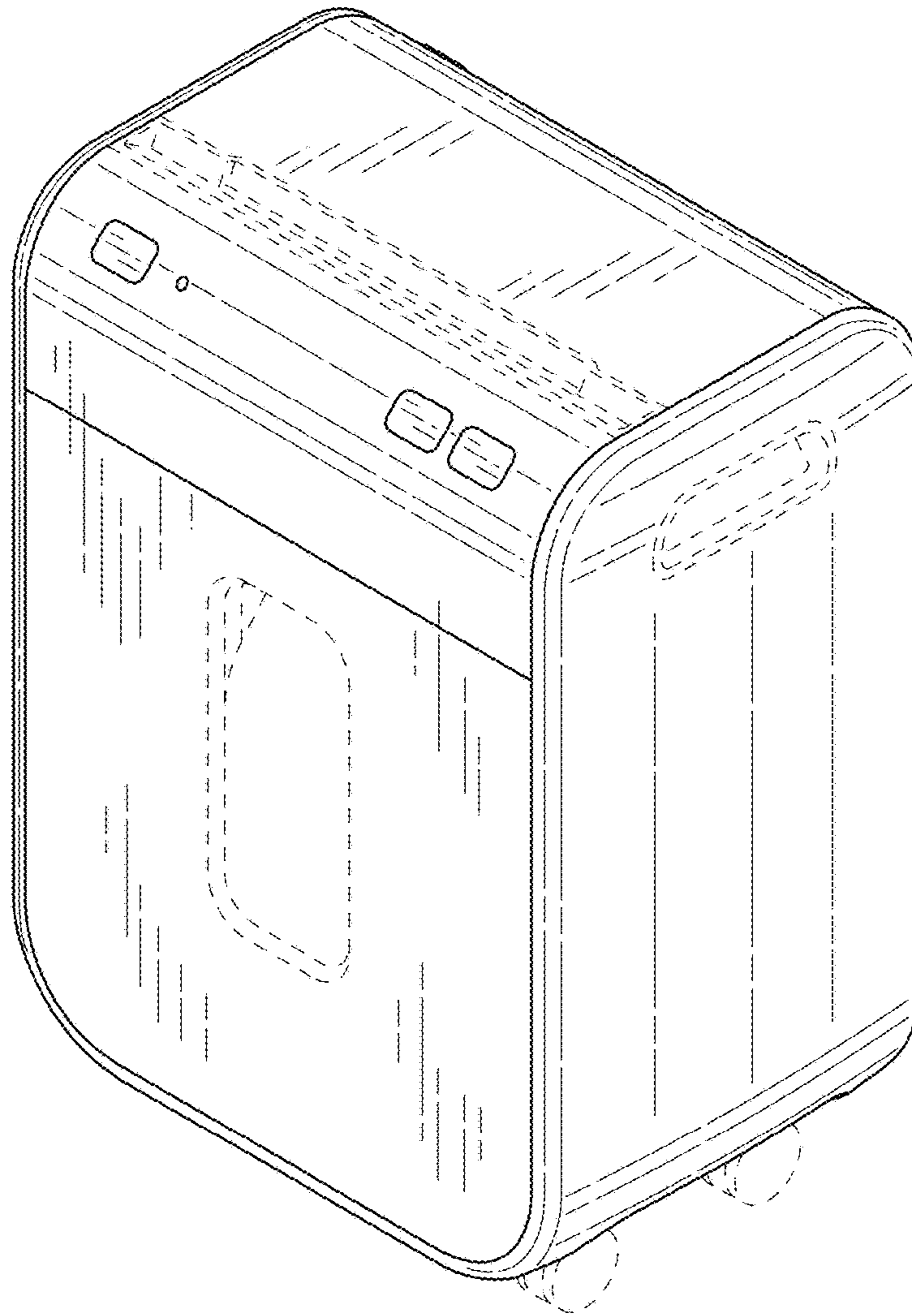

FIG.15

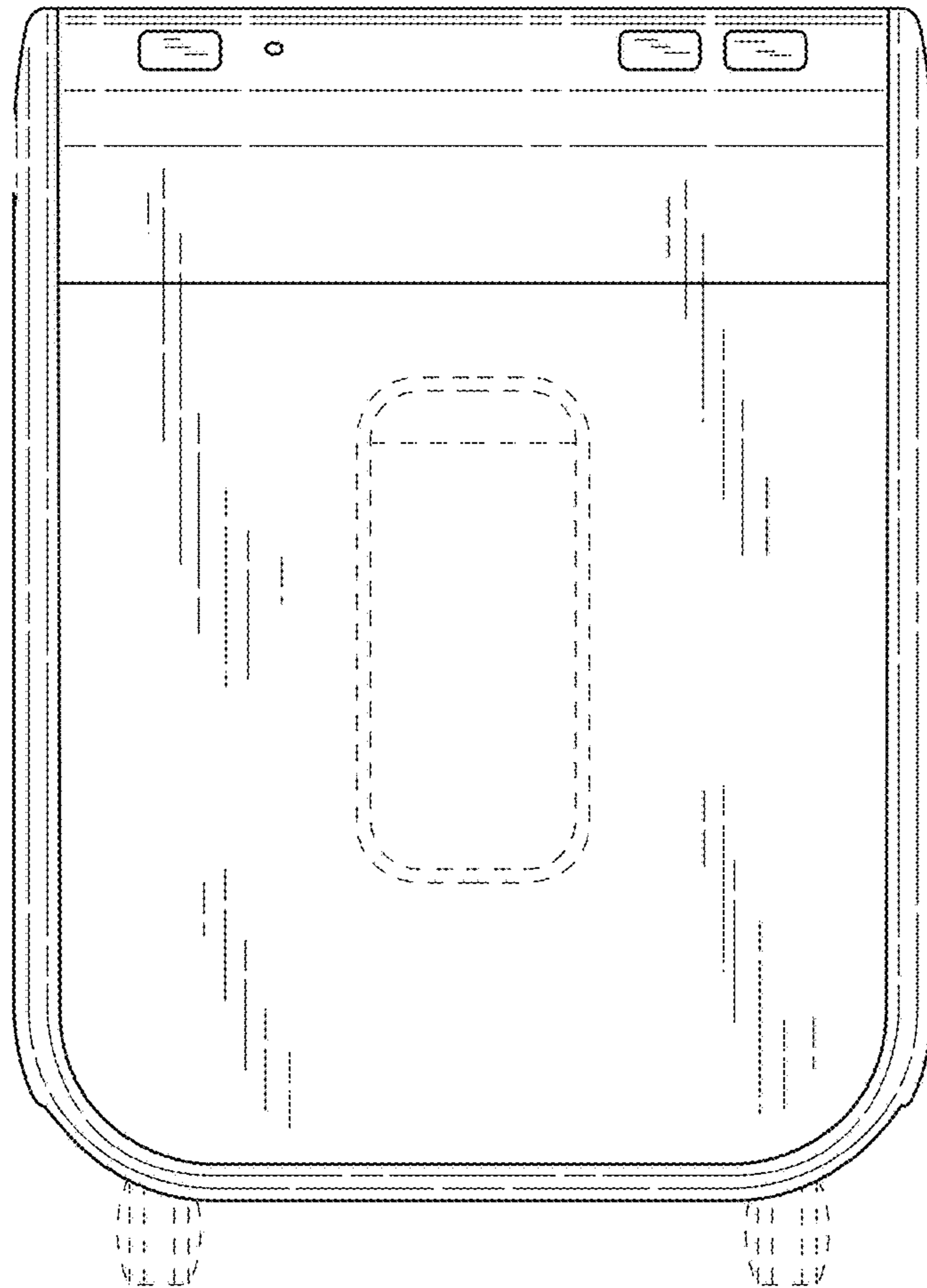

FIG.16

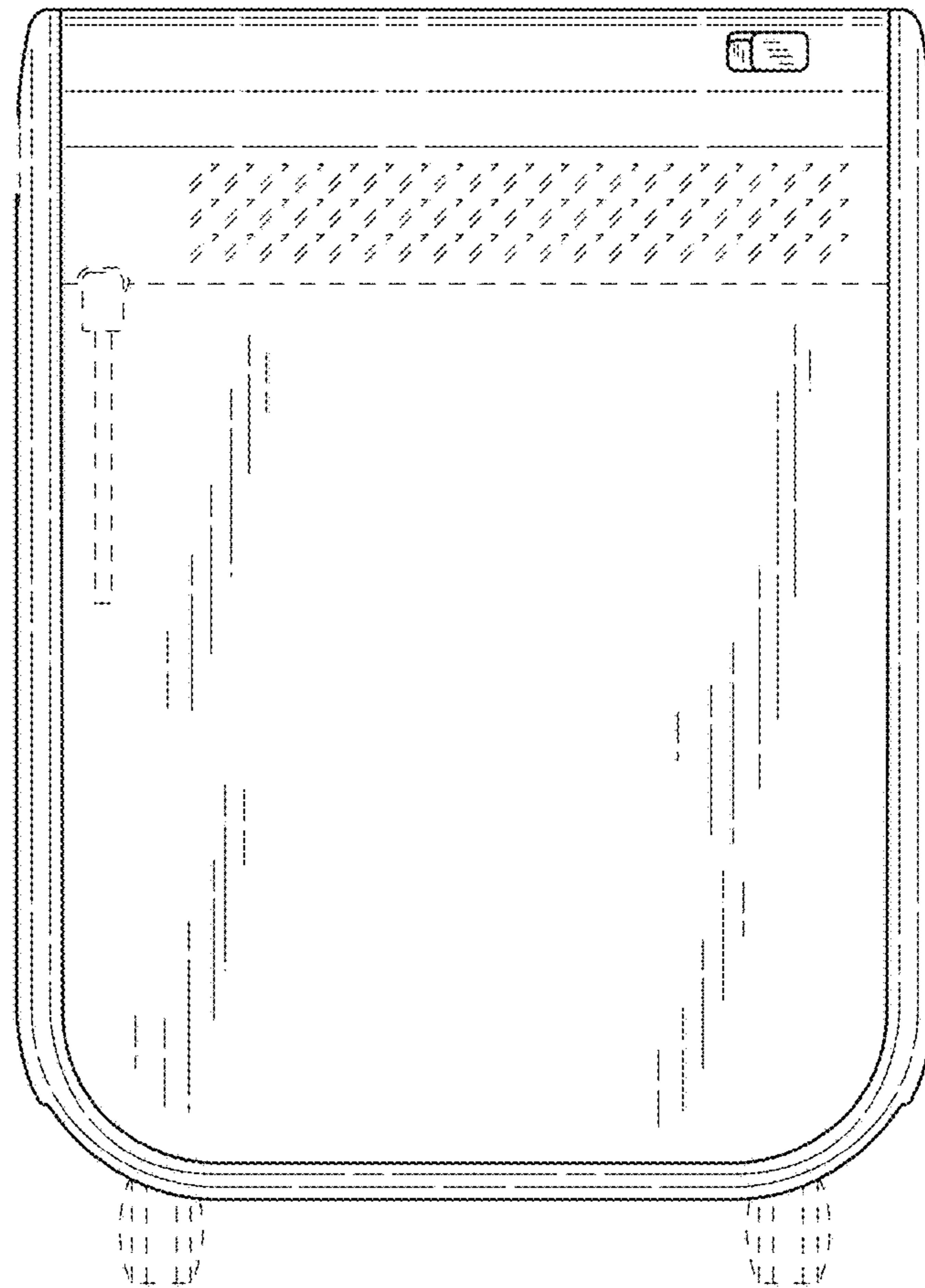

FIG.17

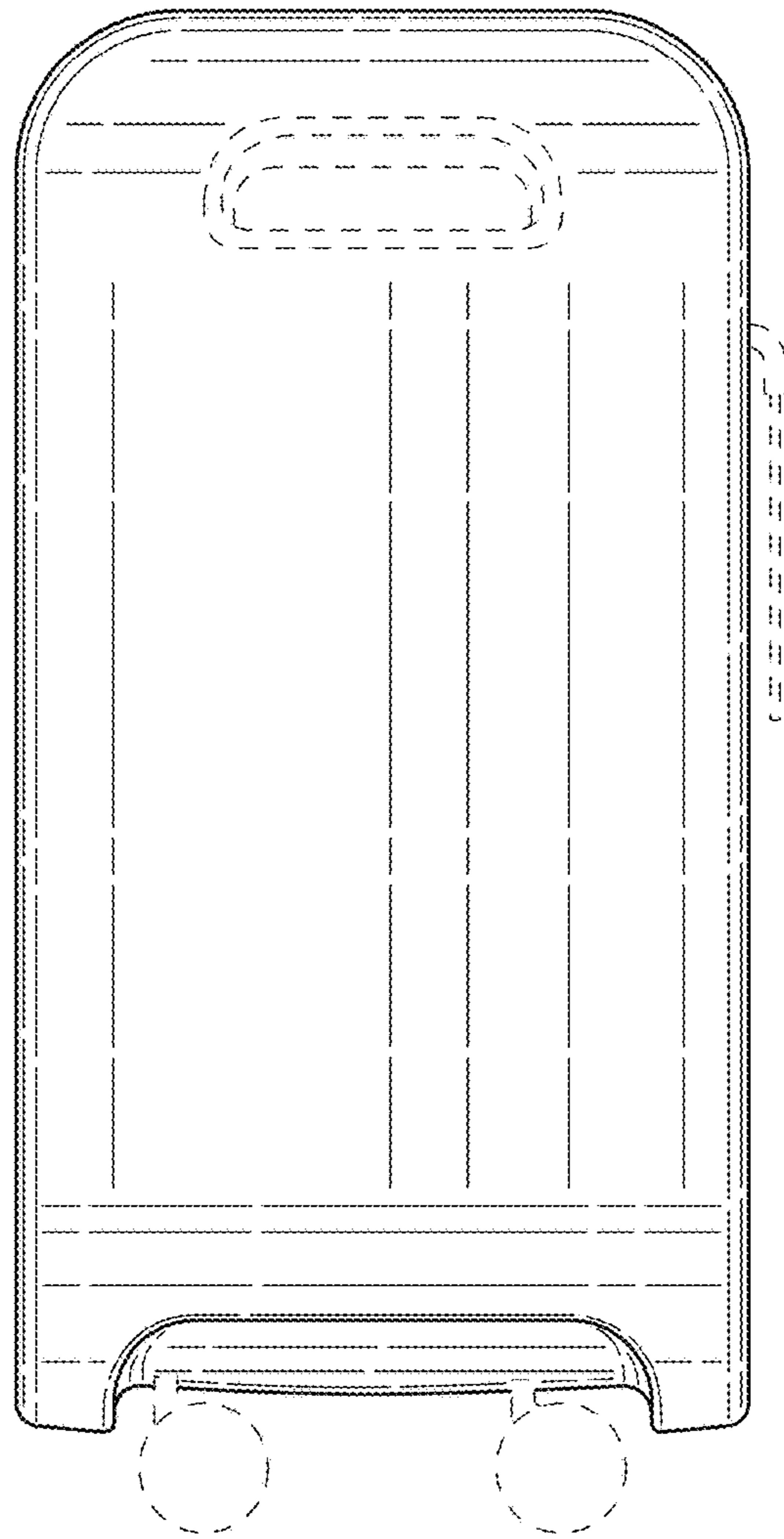

FIG. 18

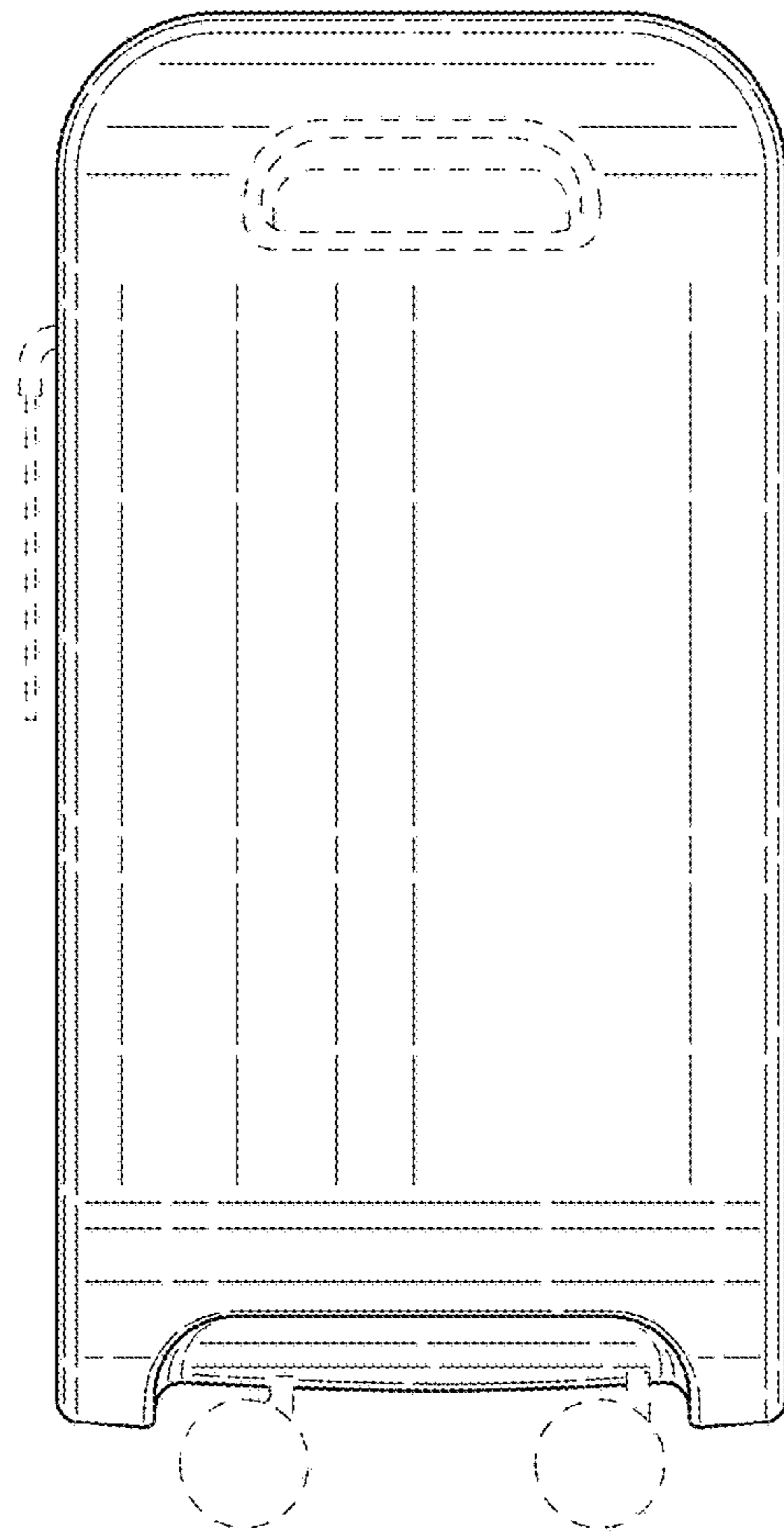

FIG. 19

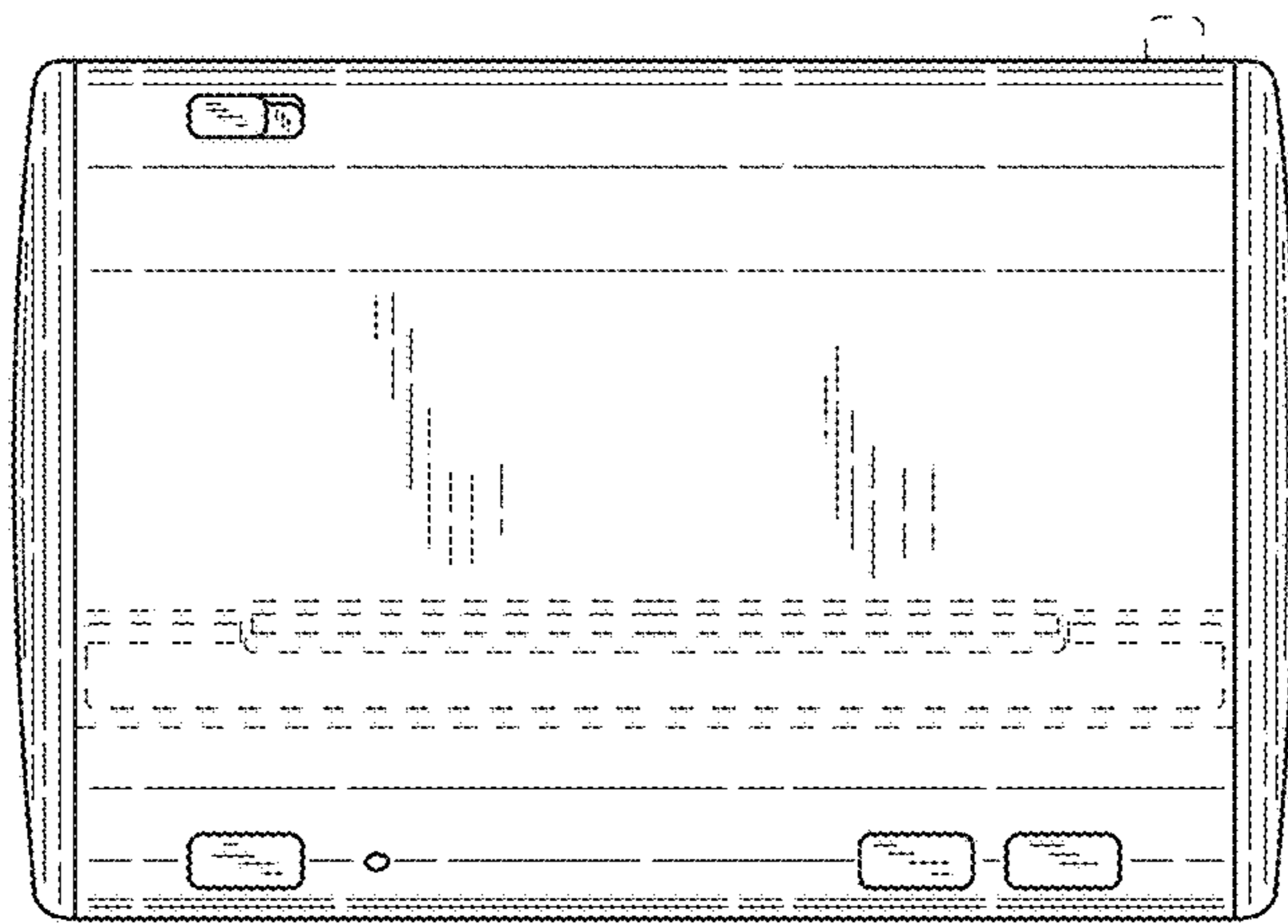

FIG.20

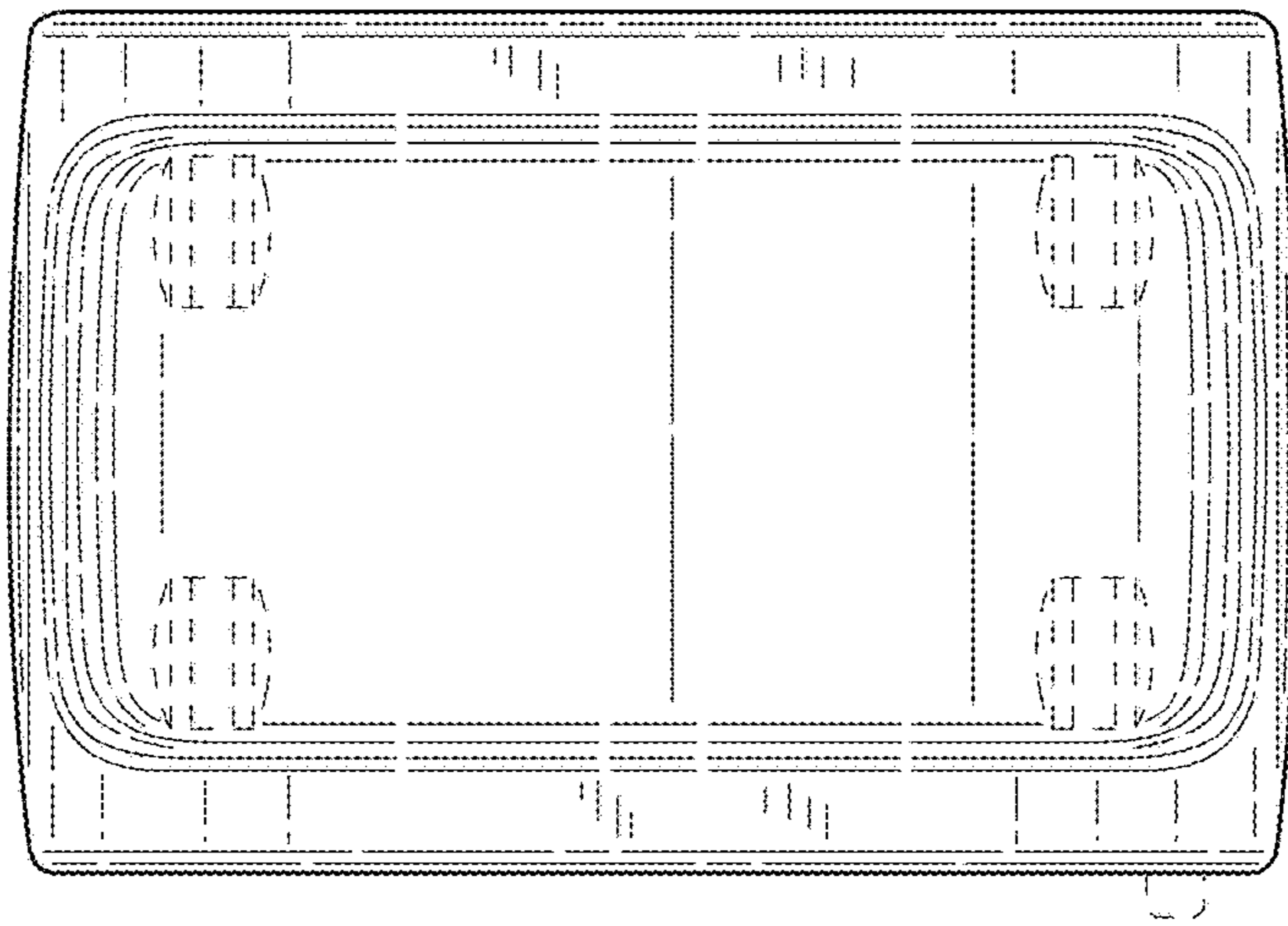

FIG.21