



US00D868063S

(12) **United States Design Patent** (10) **Patent No.:** **US D868,063 S**
Mao (45) **Date of Patent:** **** *Nov. 26, 2019**

(54) **SMART WATCH**

(71) Applicant: **Yuzhong Mao**, Leshan (CN)

(72) Inventor: **Yuzhong Mao**, Leshan (CN)

(*) Notice: This patent is subject to a terminal disclaimer.

(**) Term: **15 Years**

(21) Appl. No.: **29/701,389**

(22) Filed: **Aug. 12, 2019**

(51) **LOC (12) Cl.** **14-02**

(52) **U.S. Cl.**
USPC **D14/344**

(58) **Field of Classification Search**
USPC D14/344, 138 R, 144, 341, 358, 388;
D10/30-39, 70, 98; D11/3, 4, 26, 93-94,
D11/78.1, 79, 86; D24/167, 169,
D24/186-187, 164
CPC G06F 1/163; G06F 3/014; G04G 21/08;
G04G 15/00; A61B 5/681; H04M 1/7253
See application file for complete search history.

(56) **References Cited**

U.S. PATENT DOCUMENTS

D729,650 S *	5/2015	Phillips	D10/32
D787,960 S *	5/2017	Park	D10/39
D790,374 S *	6/2017	Lean	D10/39
D802,453 S *	11/2017	Page	D10/70
D809,144 S *	1/2018	Wu	D24/167
D815,635 S *	4/2018	Lumme	D14/344

(Continued)

FOREIGN PATENT DOCUMENTS

EM	006358073-0001	*	4/2019
EM	006704623-0001	*	8/2019
EM	006704623-0002	*	8/2019

OTHER PUBLICATIONS

Shinmax Fitness Tracker Bands, announced Jul. 30, 2018 [online], [retrieved Sep. 25, 2019]. Available from Internet, URL: <https://www.amazon.com/Shinmax-Fitness-Tracker-Activity-Monitor/dp/B07F1PVC2R> (Year: 2018).*

(Continued)

Primary Examiner — T Chase Nelson
Assistant Examiner — Dana K Weiland

(57) **CLAIM**

The ornamental design for a smart watch, as shown and described.

DESCRIPTION

FIG. 1 is a perspective view of a first embodiment of a smart watch showing my new design;
FIG. 2 is another perspective view thereof;
FIG. 3 is a front elevational view thereof;
FIG. 4 is a rear elevational view thereof;
FIG. 5 is a left side elevational view thereof;
FIG. 6 is a right side elevational view thereof;
FIG. 7 is a top plan view thereof;
FIG. 8 is a bottom plan view thereof;
FIG. 9 is an exploded perspective view of the smart watch shown in a state where the components are separated;
FIG. 10 is a perspective view of a second embodiment of the smart watch showing my new design;
FIG. 11 is another perspective view thereof;
FIG. 12 is a front elevational view thereof;
FIG. 13 is a rear elevational view thereof;
FIG. 14 is a left side elevational view thereof;
FIG. 15 is a right side elevational view thereof;
FIG. 16 is a top plan view thereof;
FIG. 17 is a bottom plan view thereof; and,
FIG. 18 is an exploded perspective view of the smart watch shown in a state where the components are separated.
The broken lines in the drawings depict portions of the smart watch that form no part of the claimed design.

1 Claim, 18 Drawing Sheets

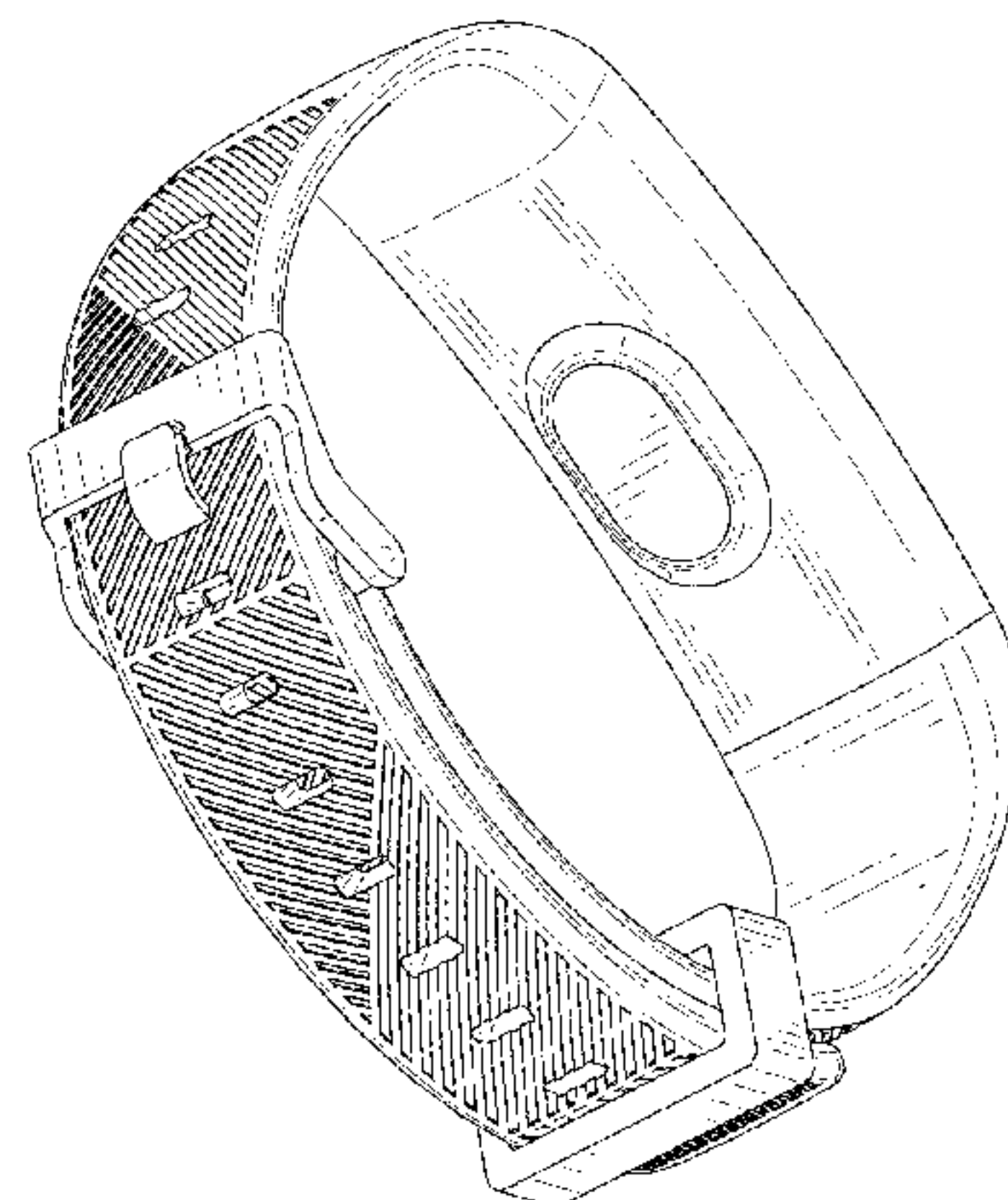
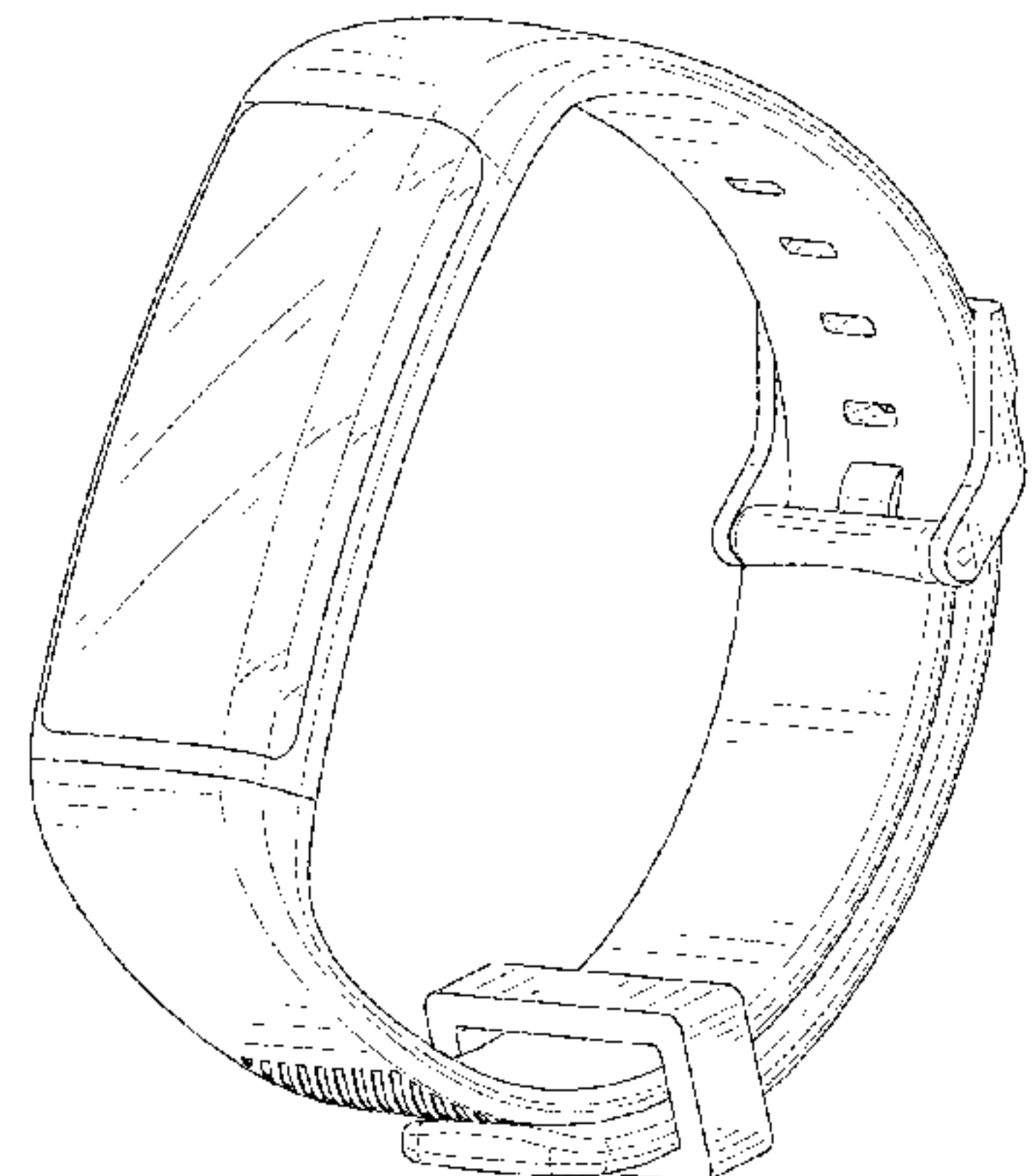

(56)

References Cited

U.S. PATENT DOCUMENTS

D816,668	S	*	5/2018	Wu	D14/344
D822,836	S	*	7/2018	Wu	D24/186
D831,644	S	*	10/2018	Wu	D14/344
D831,645	S	*	10/2018	Wu	D14/344
D833,625	S	*	11/2018	Guan	D24/186
10,136,543	B1	*	11/2018	Nadkarni	H05K 7/1427
D840,043	S	*	2/2019	Li	D24/186
D841,171	S	*	2/2019	Li	D24/186
D848,875	S	*	5/2019	Wildner	D10/70
D851,641	S	*	6/2019	Zhang	D14/344
2017/0065224	A1	*	3/2017	Rahko	A61B 5/7435
2018/0092438	A1	*	4/2018	Vandenbussche	A44B 11/24
2019/0041806	A1	*	2/2019	Zhang	G04B 37/0033

OTHER PUBLICATIONS

Y5 Color Screen Fitness Tracker, announced 2019 [online], [retrieved Sep. 25, 2019]. Available from Internet, URL: <<https://www.rakuten.com/shop/gadgetdea124/product/SH-Y5/>> (Year: 2019).*

HuaWise Fitness Tracker, announced 2019 [online], [retrieved Sep. 25, 2019]. Available from Internet, URL: <<https://dealrice.com/deal-107575.html>> (Year: 2019).*

OCTelect Health, announced 2019 [online], [retrieved Sep. 25, 2019]. Available from Internet, URL: <<http://www.oct-tech.com/product/en/OCTelect-Health-wristband-fitness-tracker-for-women-child--amp--men--color-screen-fitness-tracker-blood-pressure-monitor-Call-Media-message-Remind-.html>> (Year: 2019).*

“KOBWA Fitness Tracker with Step Tracker, Activity Tracker Watch with Color Screen, Waterproof Pedometer Watch with Heart Rate Monitor, Pedometer Watch for Kids Women and Men, Android IOS”, Retrieved Aug. 12, 2019]. Retrieved from Internet, <https://www.amazon.co.uk/KOBWA-Fitness-Activity-Waterproof-Pedometer/dp/307G26N1RW/>.

“OCTelect Color OLED touch screen smart band IP68 waterproof, Fitness health monitoring wristbands blood pressure pedometer activiy tracker health care wristband for Children men & women”, Retrieved Aug. 12, 2019]. Retrieved from Internet, <https://www.amazon.co.uk/OCTelect-waterproof-monitoring-wristbands-pedometer/dp/B07C75NBRD/>.

* cited by examiner

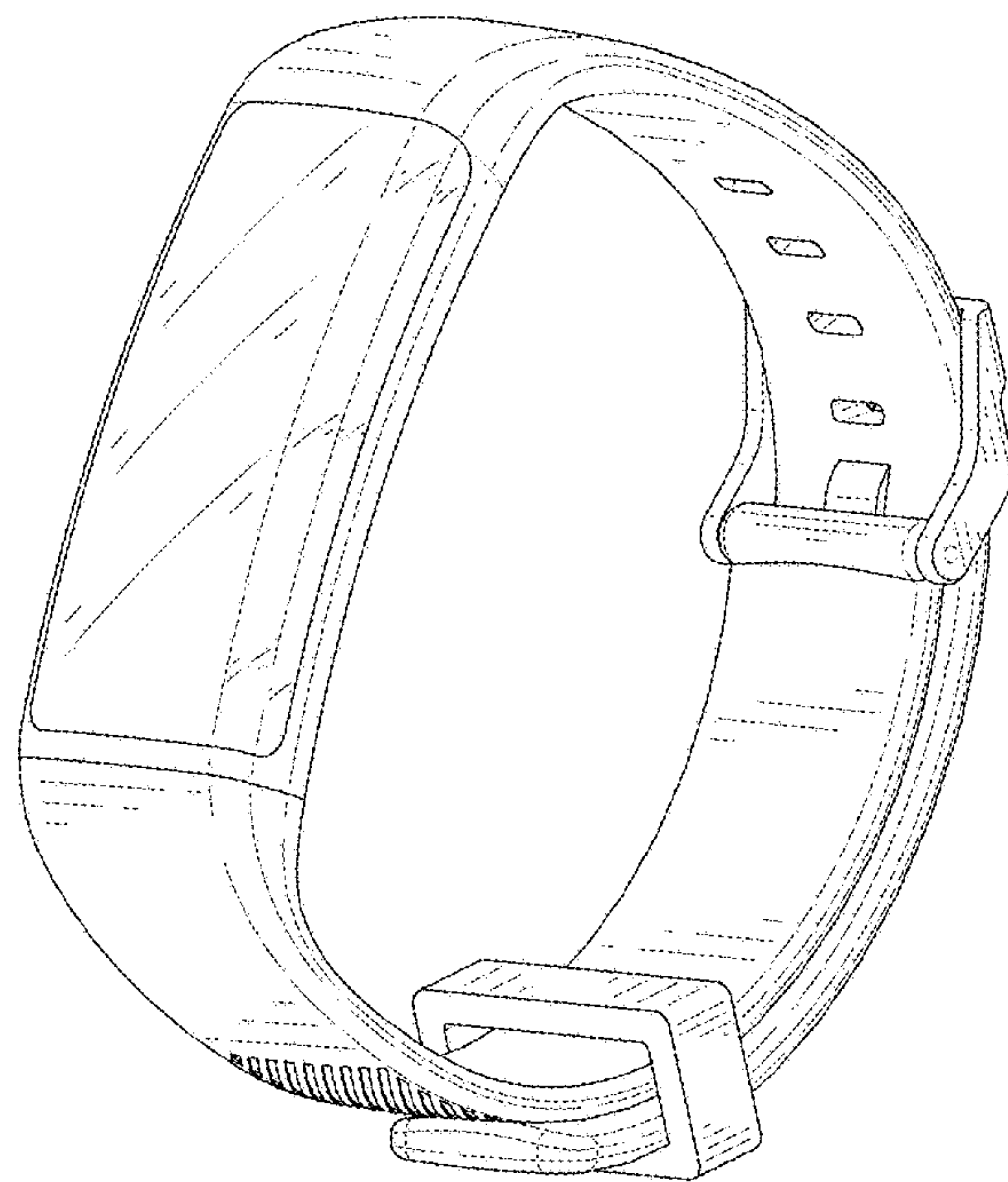

FIG. 1

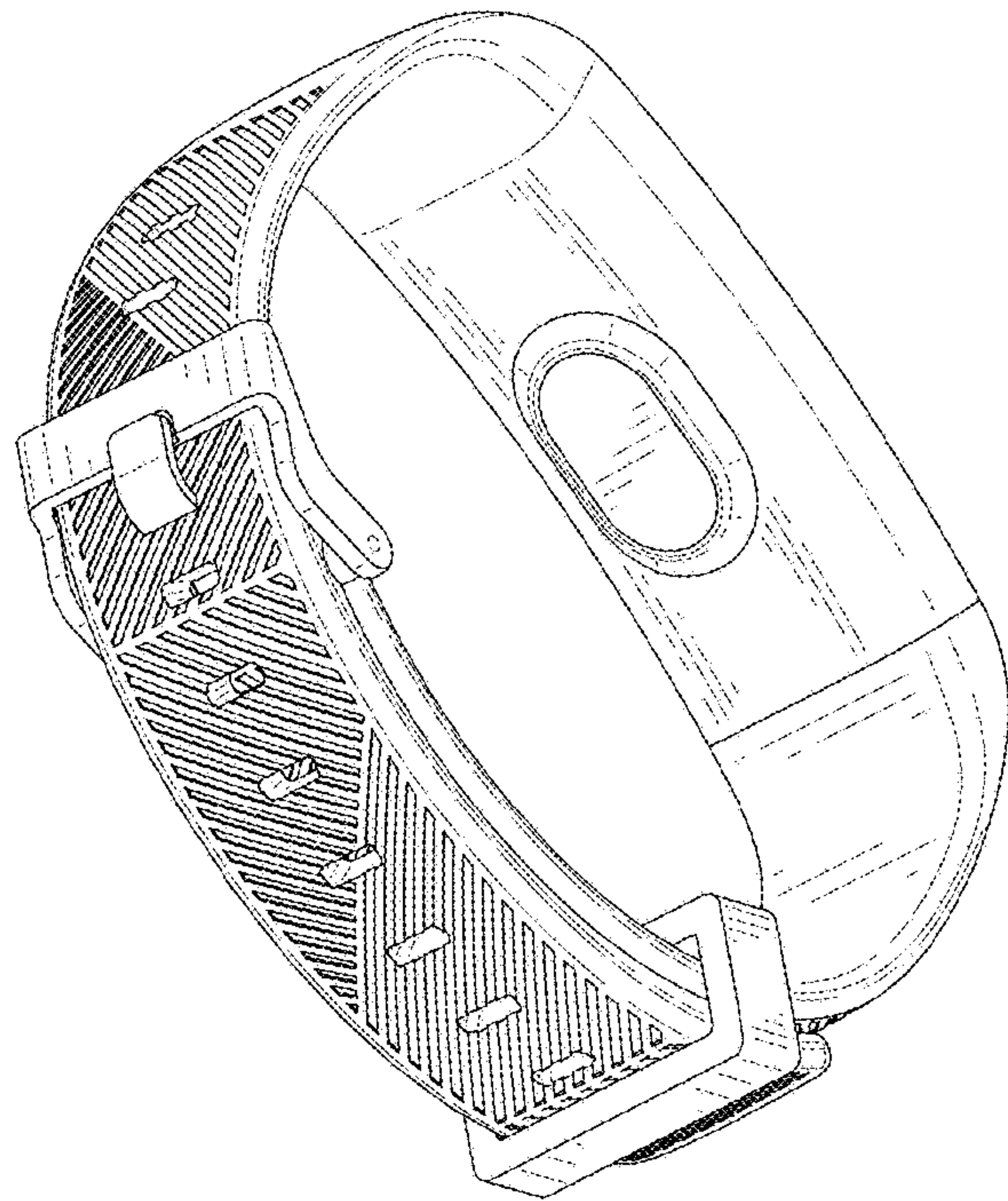

FIG. 2

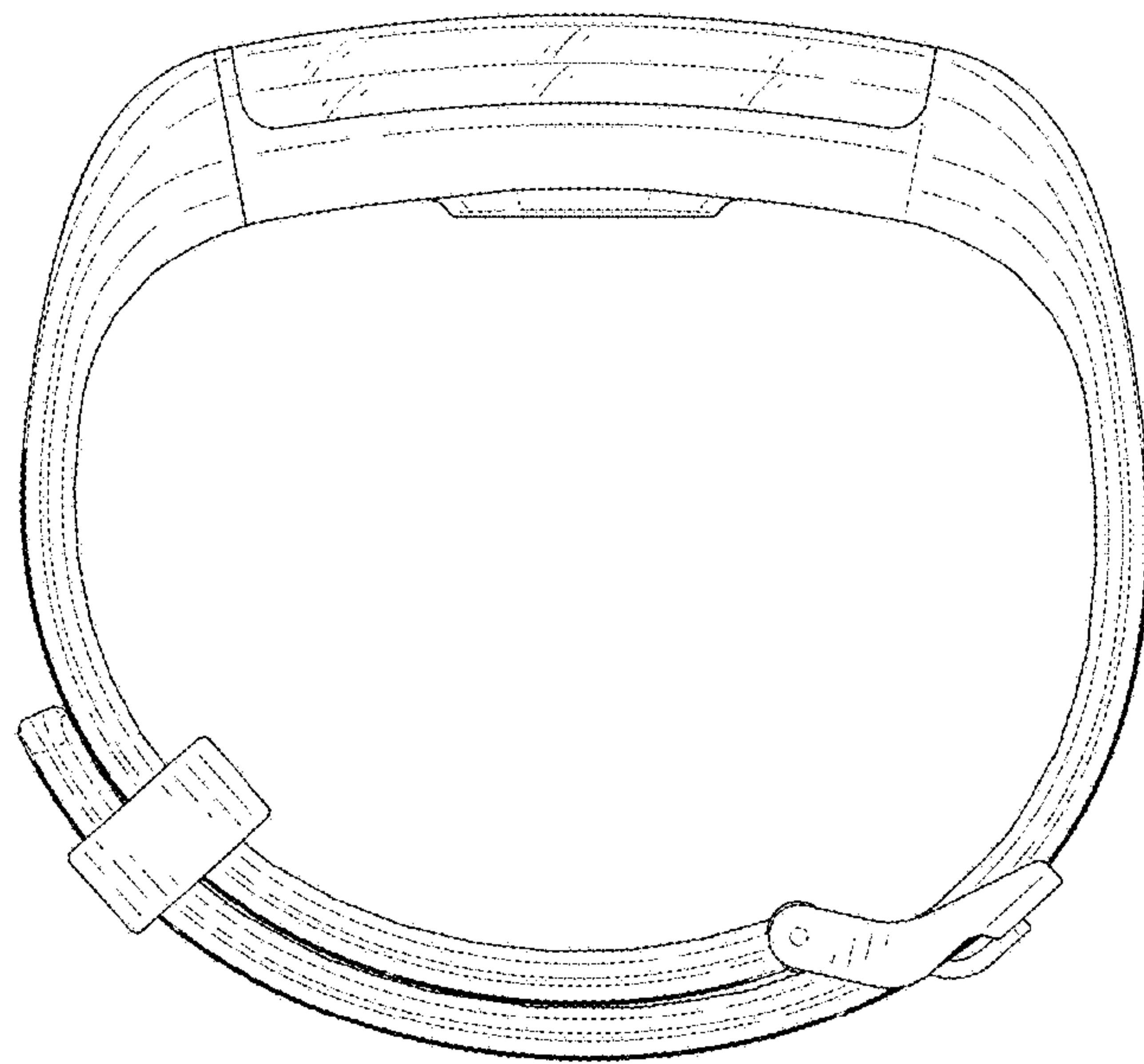

FIG. 3

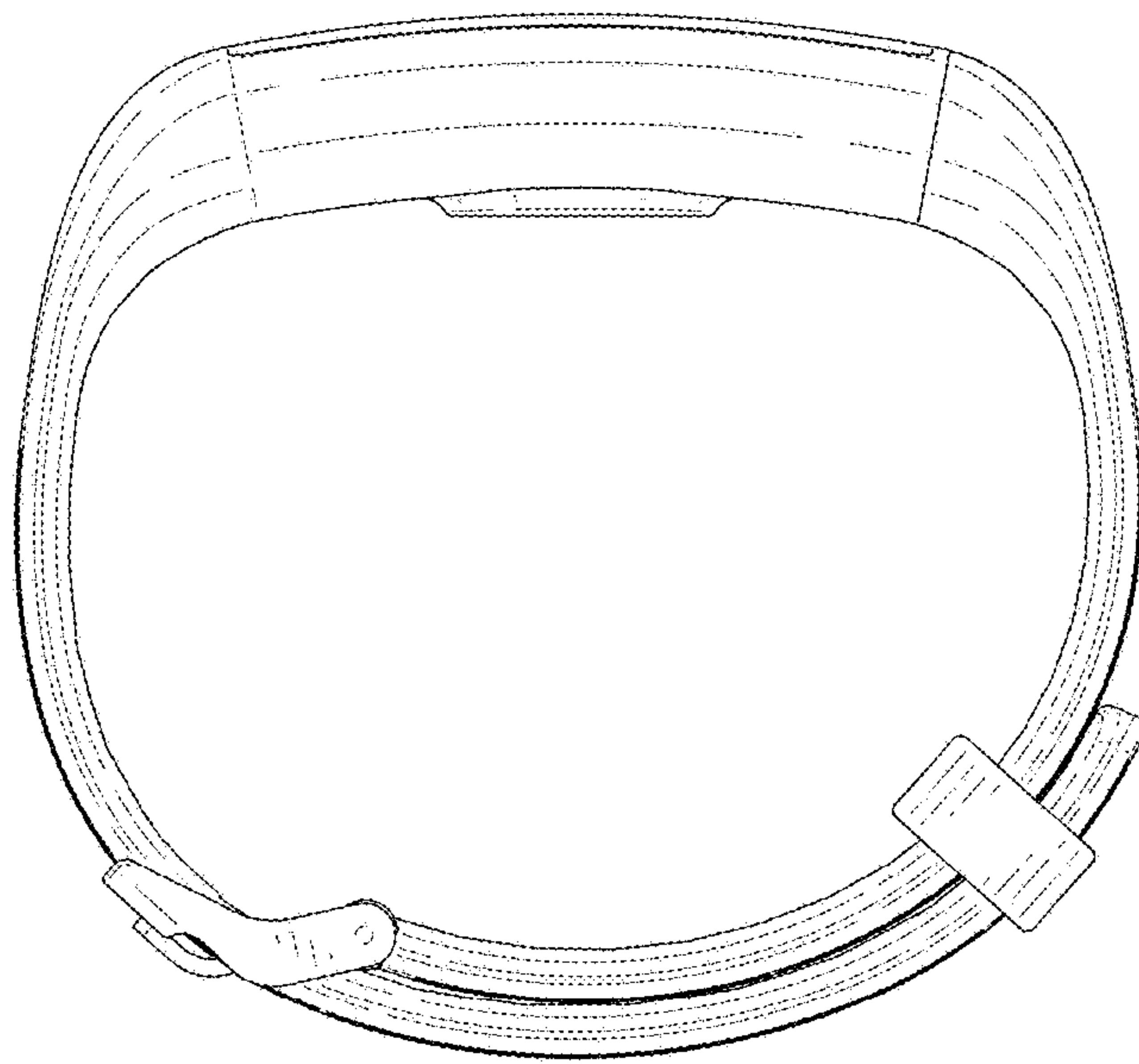

FIG. 4

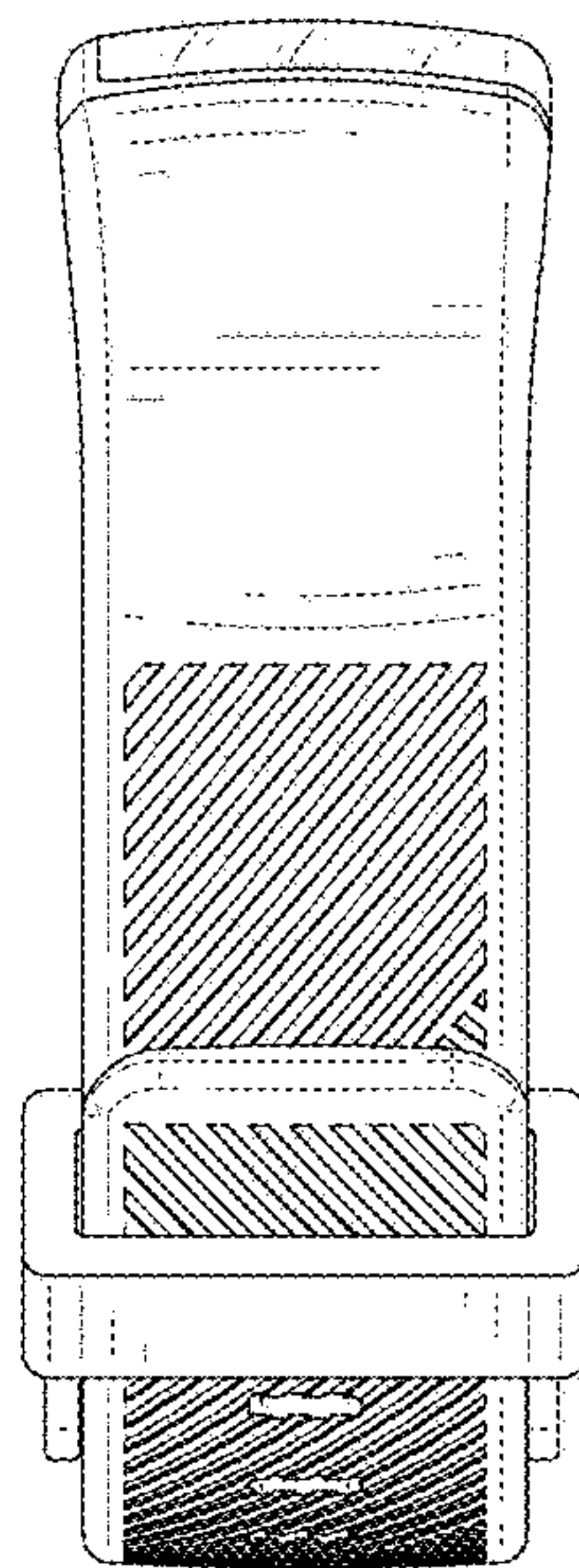

FIG. 5

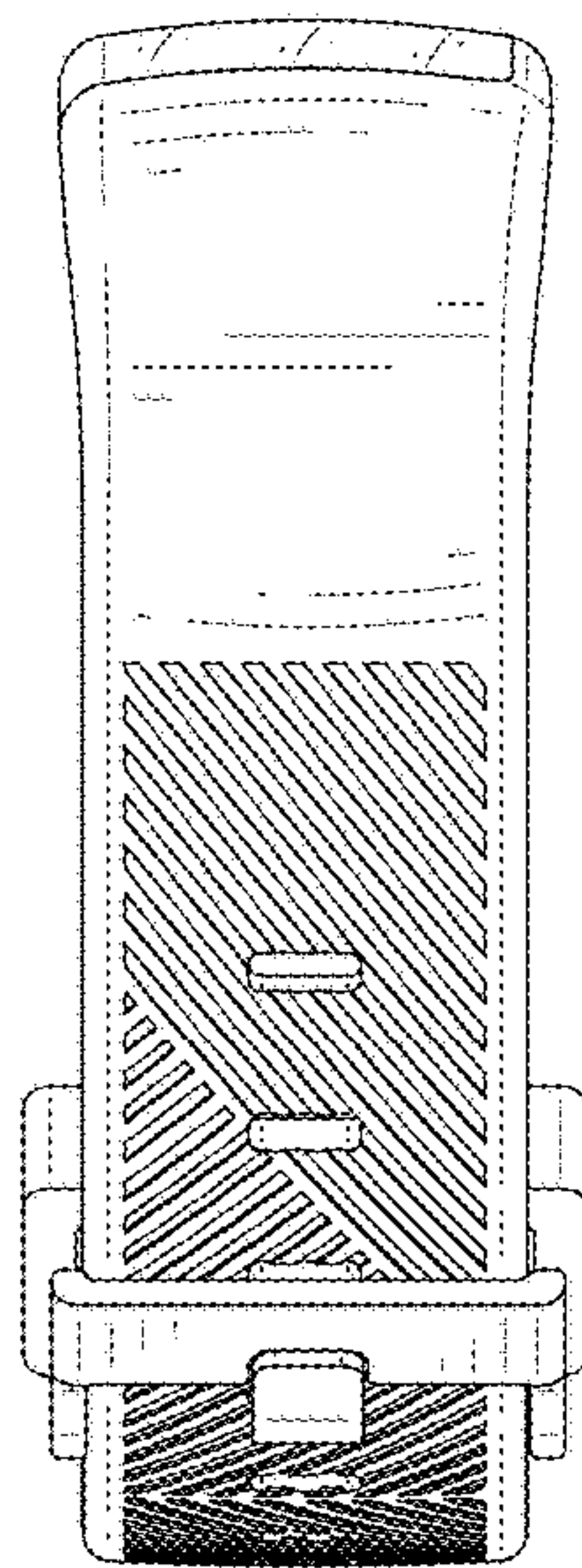

FIG. 6

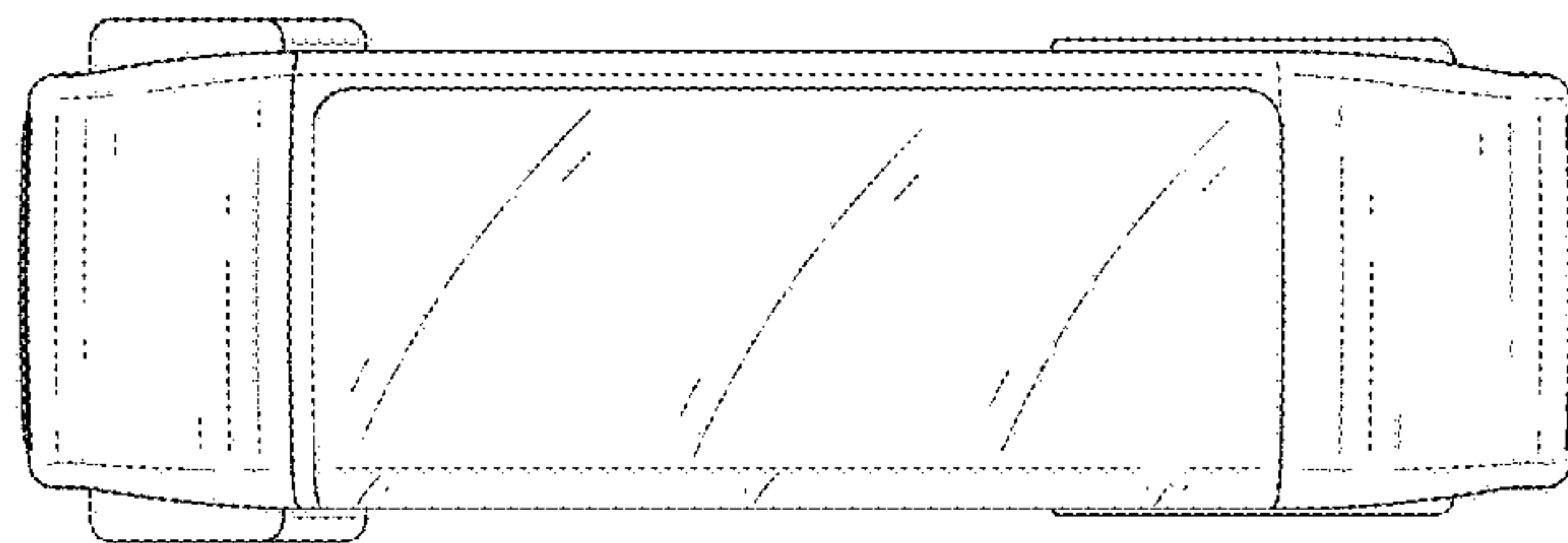

FIG. 7

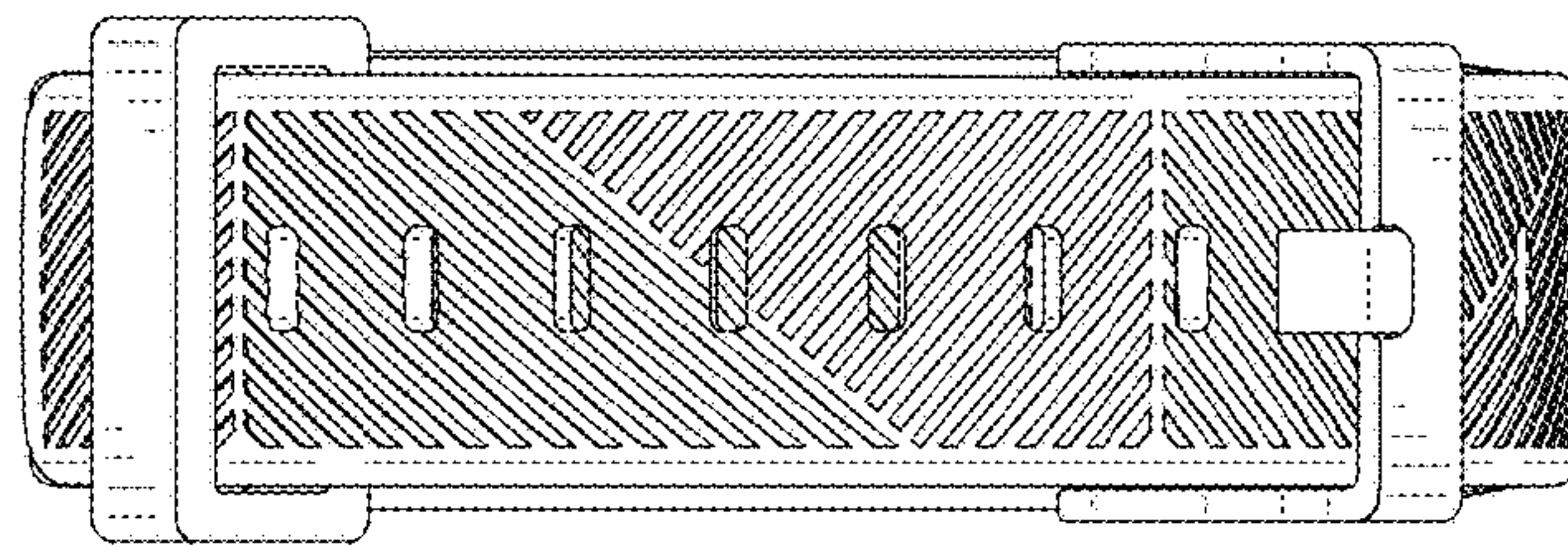

FIG. 8

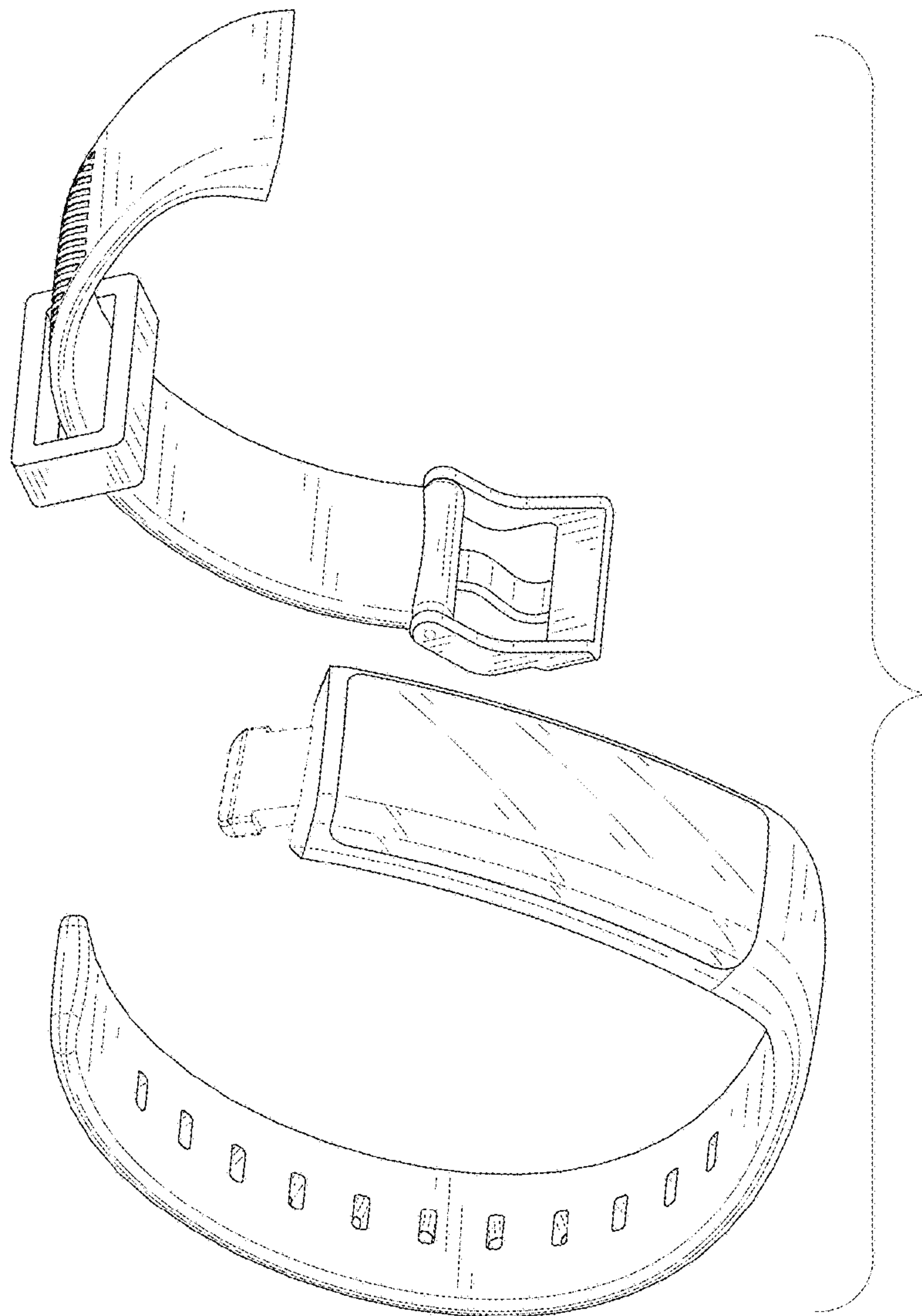

FIG. 9

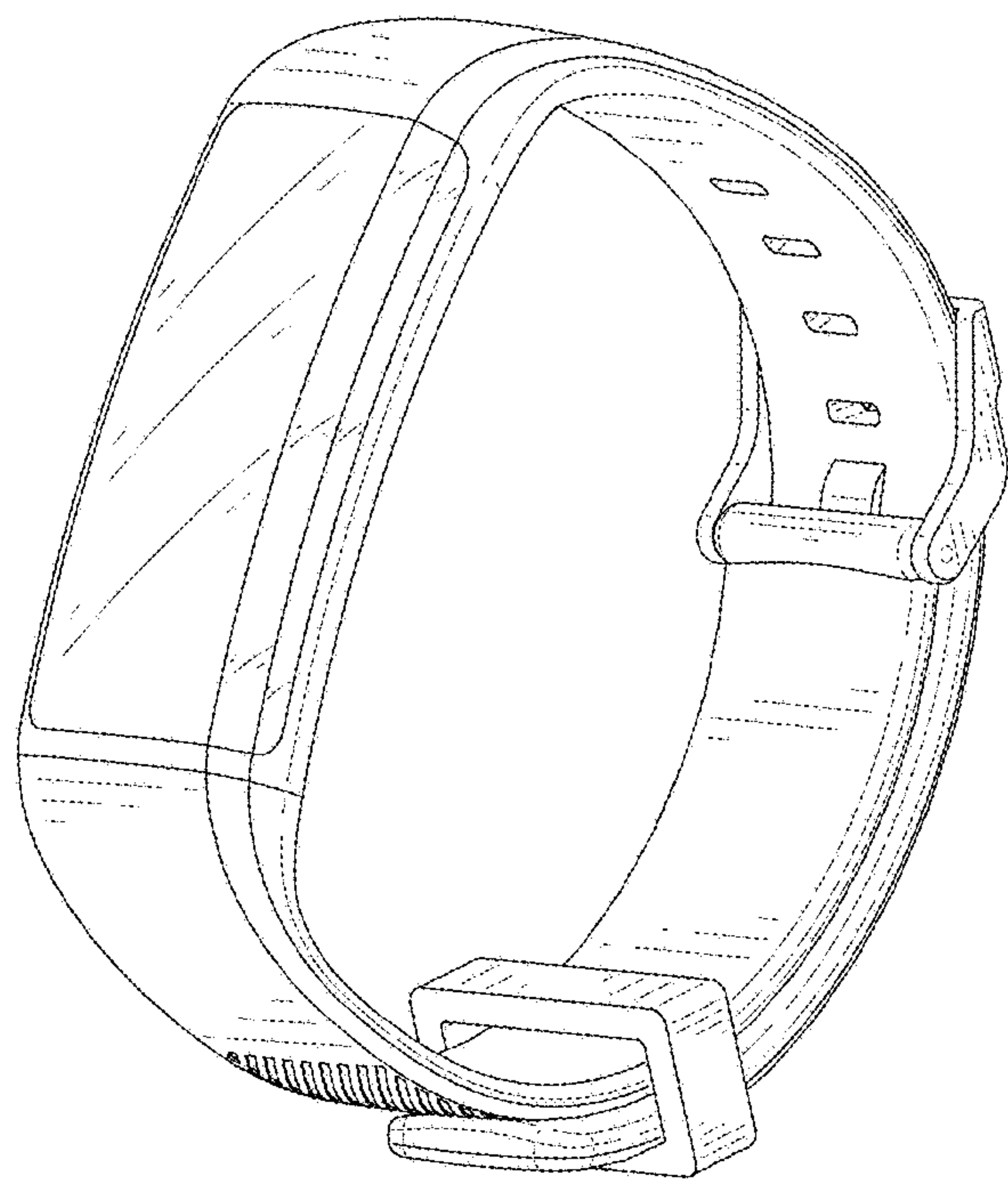

FIG. 10

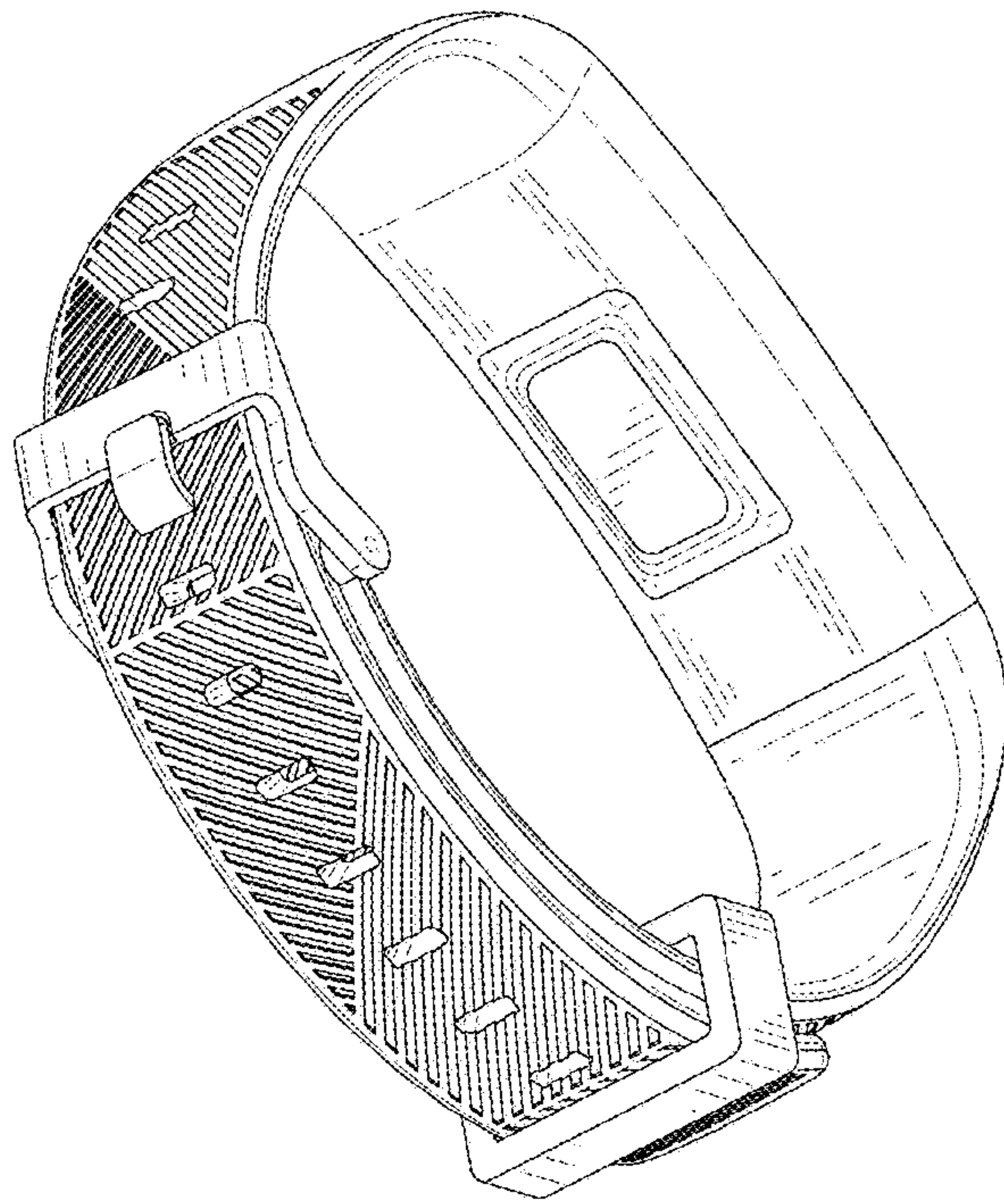

FIG. 11

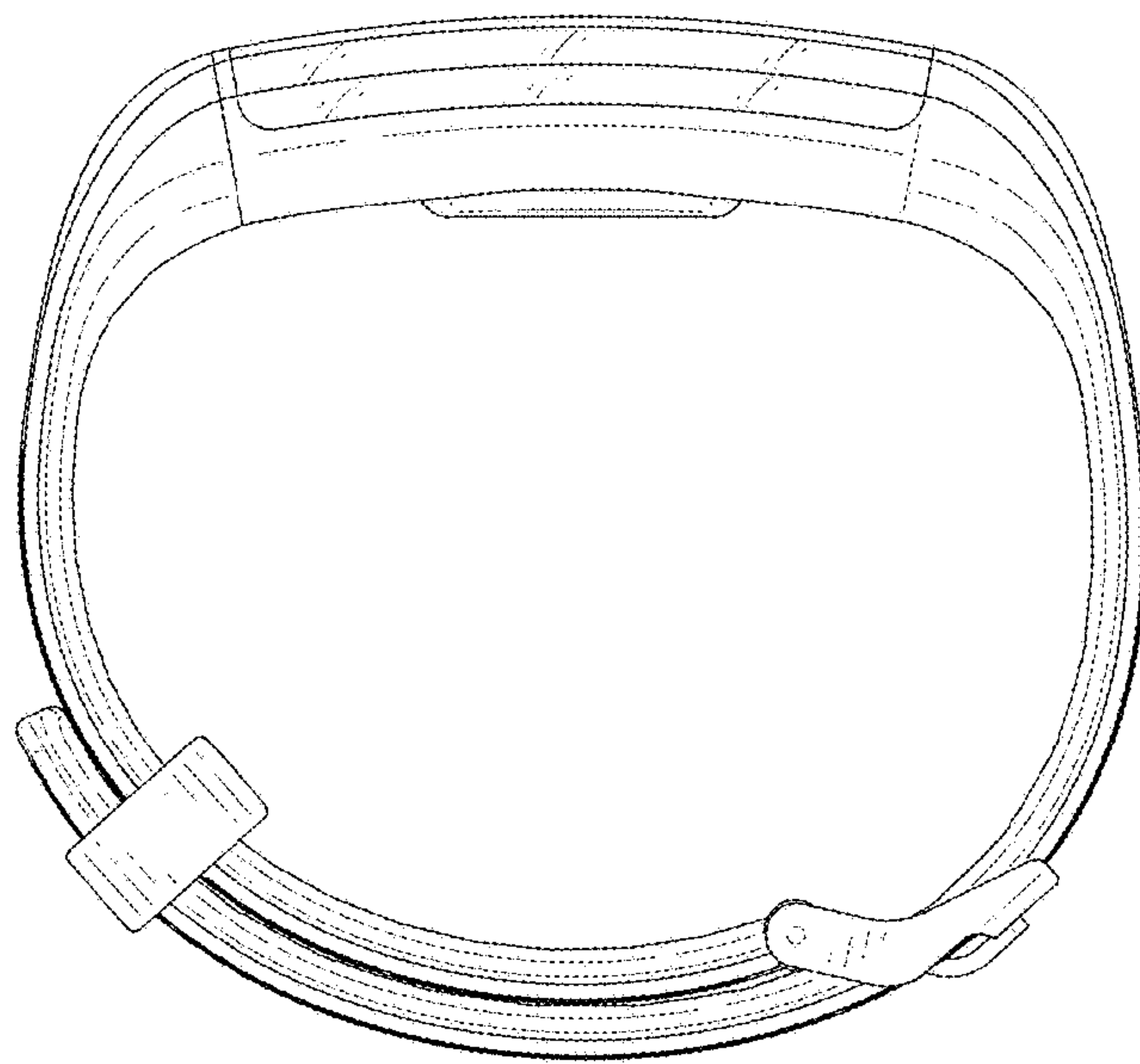

FIG. 12

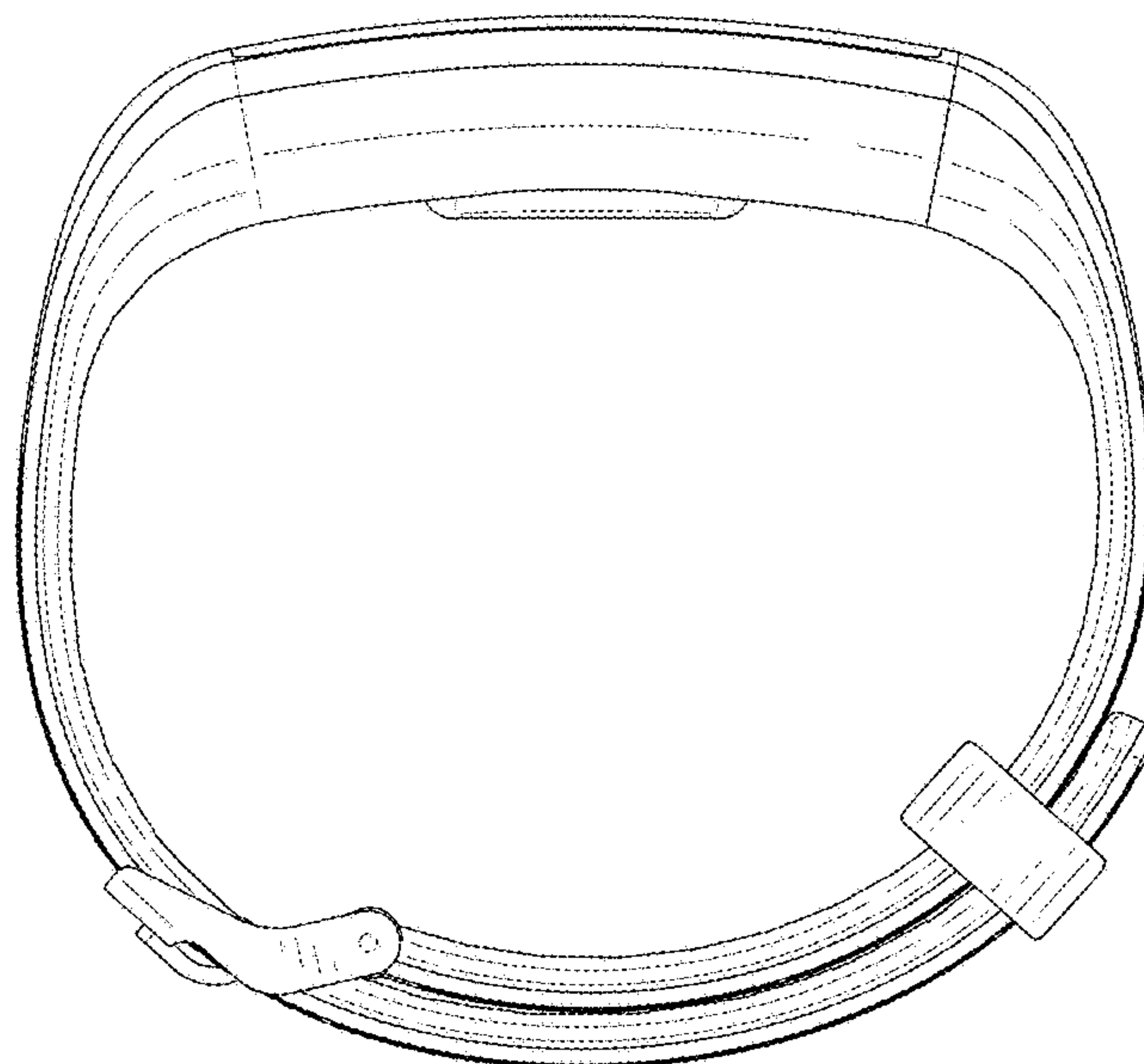

FIG. 13

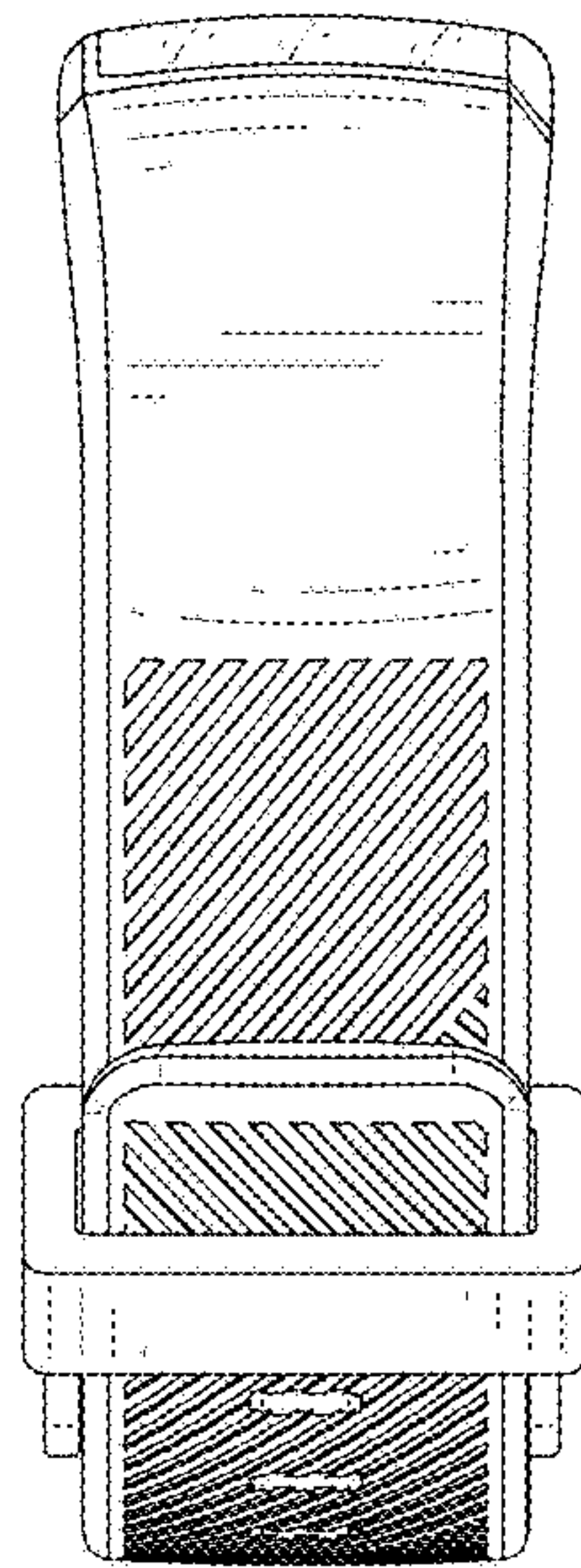

FIG. 14

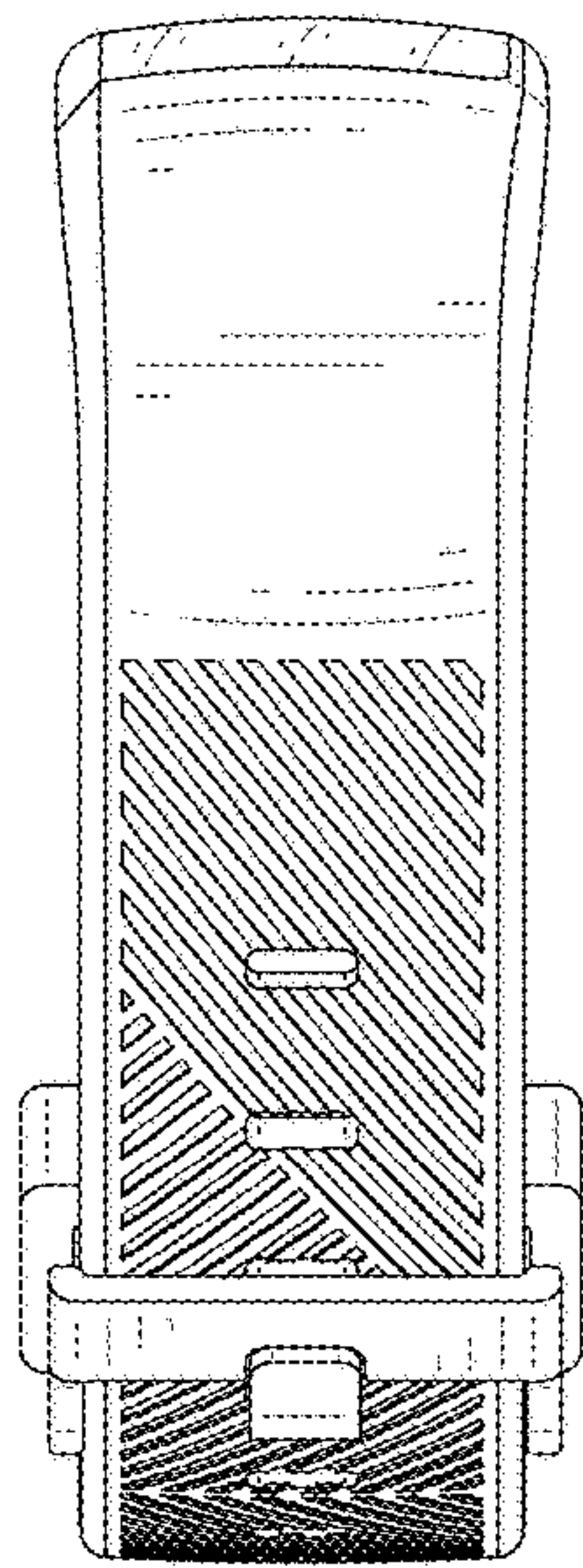

FIG. 15

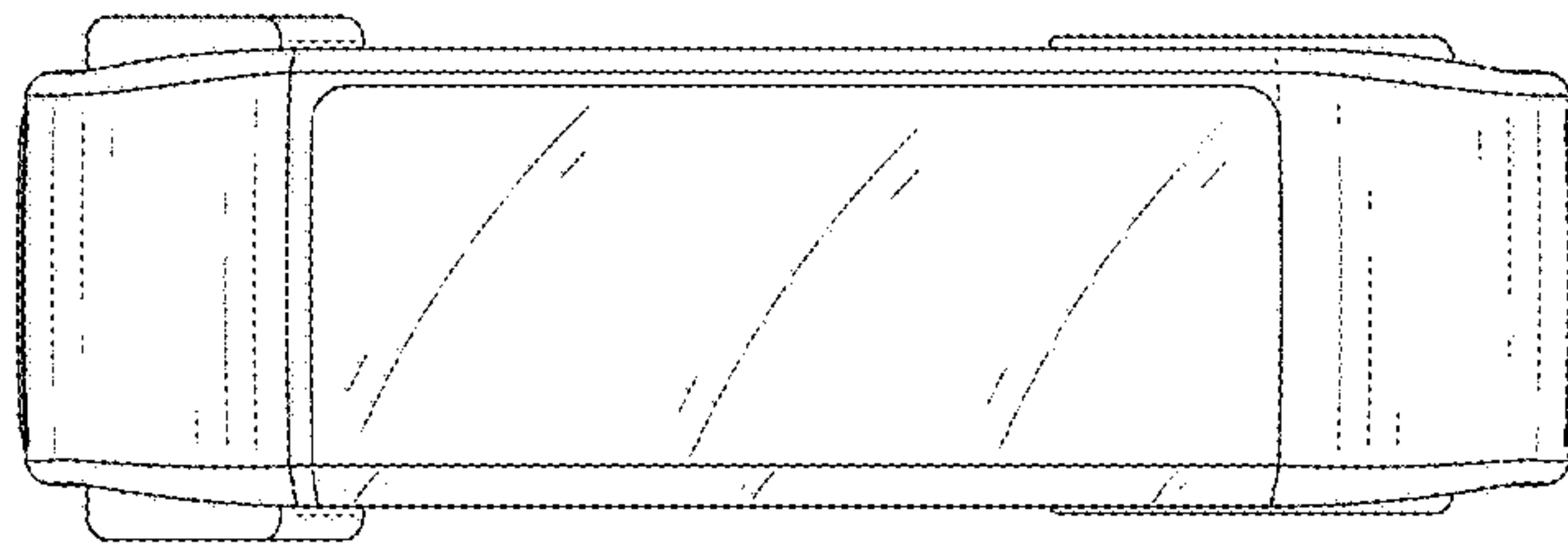

FIG. 16

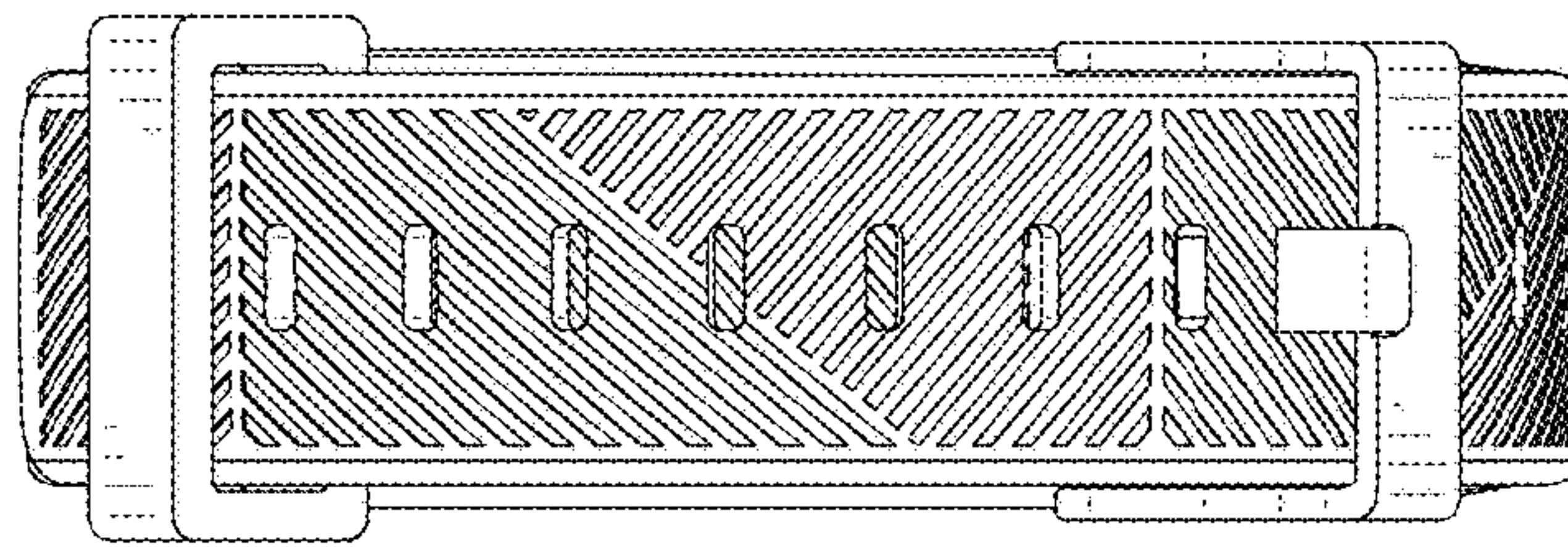

FIG. 17

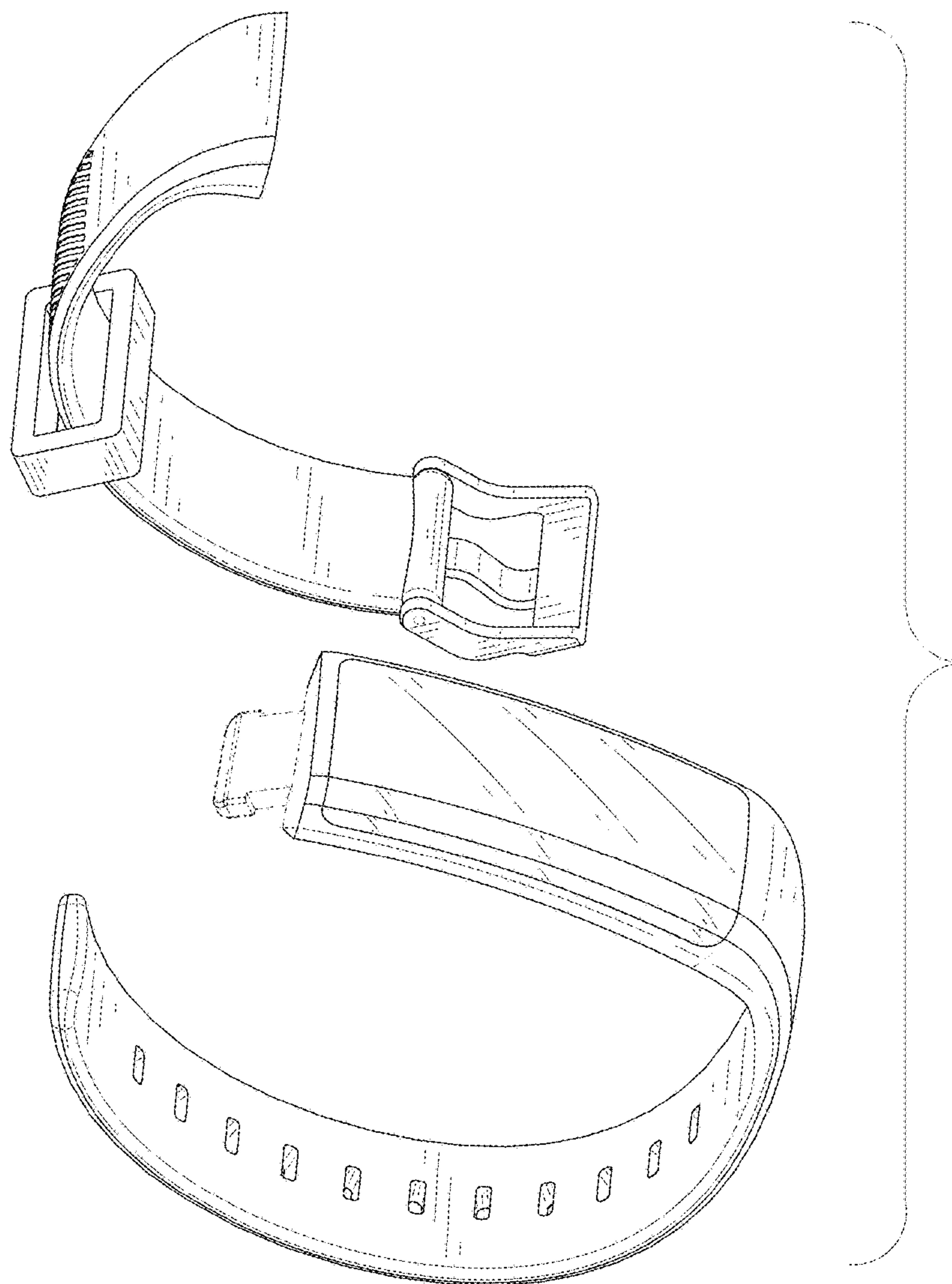

FIG. 18