



US00D868053S

(12) **United States Design Patent**  
**Gao**

(10) **Patent No.:** **US D868,053 S**

(45) **Date of Patent:** **\*\* Nov. 26, 2019**

(54) **SMARTPHONE COVER**

(71) Applicant: **Bo Gao**, Hefei (CN)

(72) Inventor: **Bo Gao**, Hefei (CN)

(\*\*) Term: **15 Years**

(21) Appl. No.: **29/648,091**

(22) Filed: **May 18, 2018**

(51) **LOC (12) Cl.** ..... **14-03**

(52) **U.S. Cl.**  
USPC ..... **D14/250**

(58) **Field of Classification Search**  
USPC ..... D3/201, 218, 226, 227, 247, 249, 250,  
D3/269, 303; D13/103, 107, 108, 119;  
D14/137, 138 R, 138 AA, 138 C, 138 G,  
D14/172, 192, 203.3–203.7, 217, 238.1,  
D14/247, 248, 250–253, 434, 440, 447,  
D14/496

CPC ..... H04B 1/3888; H04M 1/0283; H04M  
1/0202; A45C 1/06; A45C 2011/002;  
A45C 11/00; A45F 2005/028; A45F  
2200/0525

See application file for complete search history.

(56) **References Cited**

**U.S. PATENT DOCUMENTS**

D671,933 S *	12/2012	Rodgers	.....	D14/250
D709,486 S *	7/2014	Lin	.....	D14/250
D716,782 S *	11/2014	Macrina	.....	D14/250
D717,779 S *	11/2014	Dong	.....	D14/250
D726,170 S *	4/2015	Ng	.....	D14/250
9,072,353 B2 *	7/2015	Fathollahi	.....	A45C 13/002

D737,276 S *	8/2015	Armstrong	.....	D14/440
D755,764 S *	5/2016	Dong	.....	D14/250
D766,885 S *	9/2016	Armstrong	.....	D14/250
D766,907 S *	9/2016	Veltz	.....	D14/440
D768,123 S *	10/2016	Armstrong	.....	D14/250
D773,447 S *	12/2016	Taylor	.....	D14/250
D775,596 S *	1/2017	Guo	.....	D14/138 G
D786,192 S *	5/2017	Liu	.....	D13/107
D791,759 S *	7/2017	Lin	.....	D14/250
D794,625 S *	8/2017	Armstrong	.....	D14/250
D794,626 S *	8/2017	Armstrong	.....	D14/250
D797,695 S *	9/2017	Yoshihara	.....	D14/138 G
D802,576 S *	11/2017	Ahn	.....	D14/250
D808,371 S *	1/2018	Kim	.....	D14/250
D808,918 S *	1/2018	Wei	.....	D14/138 G
D816,654 S *	5/2018	Chen	.....	D14/250

\* cited by examiner

*Primary Examiner* — Susan E Krakower  
*Assistant Examiner* — L. A. Grabenstetter

(57) **CLAIM**

The ornamental design for a smartphone cover, as shown and described.

**DESCRIPTION**

FIG. 1 is a front elevational view of a smartphone cover showing my new design;  
FIG. 2 is a rear elevational view thereof;  
FIG. 3 is a right side elevational view thereof;  
FIG. 4 is a left side elevational view thereof;  
FIG. 5 is a bottom plan view thereof;  
FIG. 6 is a top plan view thereof;  
FIG. 7 is a front perspective view thereof; and,  
FIG. 8 is the rear perspective view thereof.

**1 Claim, 8 Drawing Sheets**

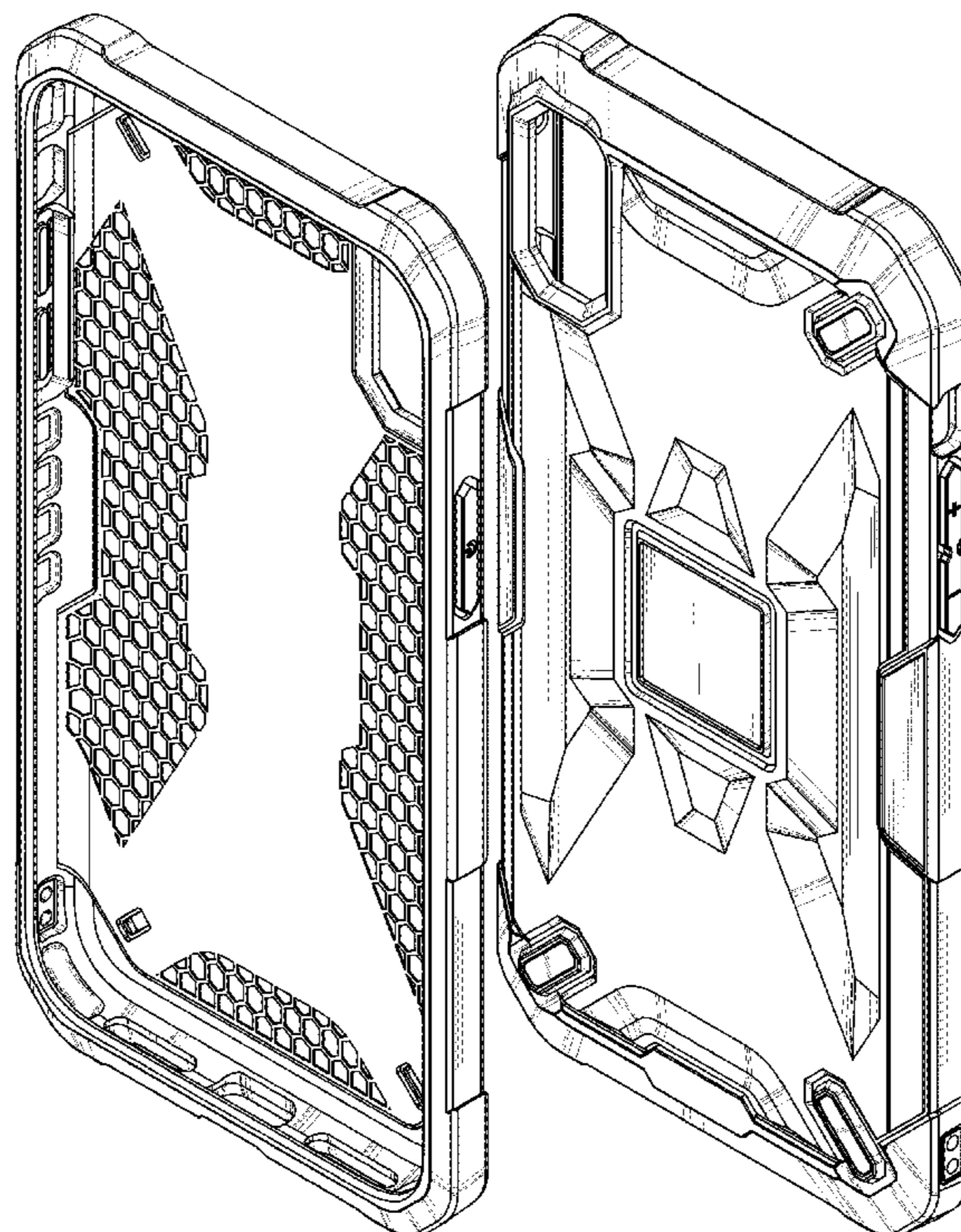

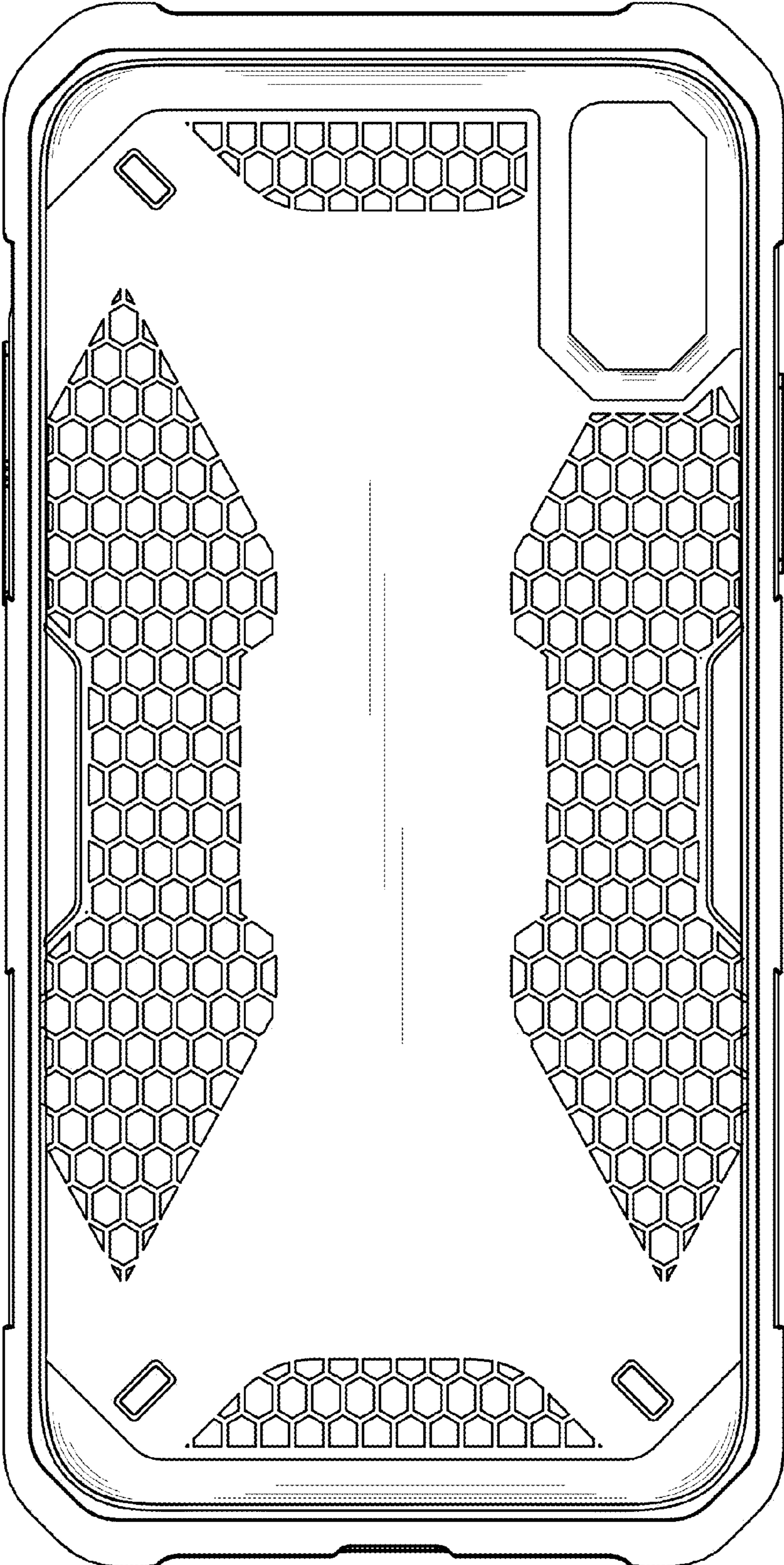

FIG. 1

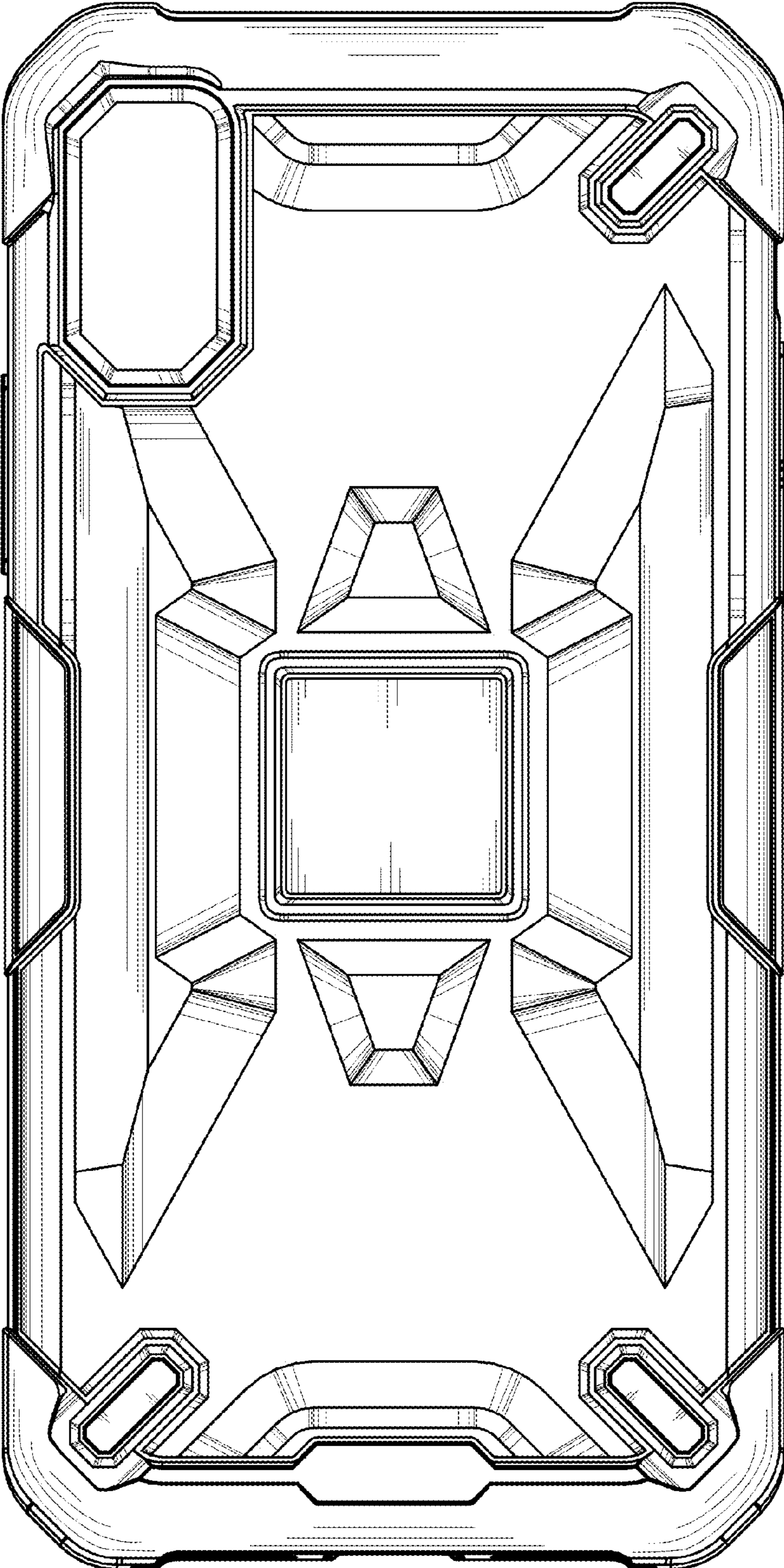

FIG. 2

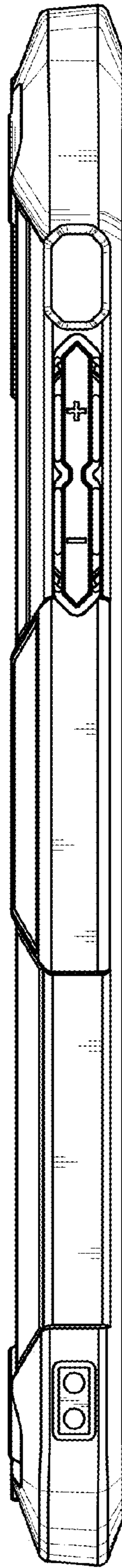

FIG. 3

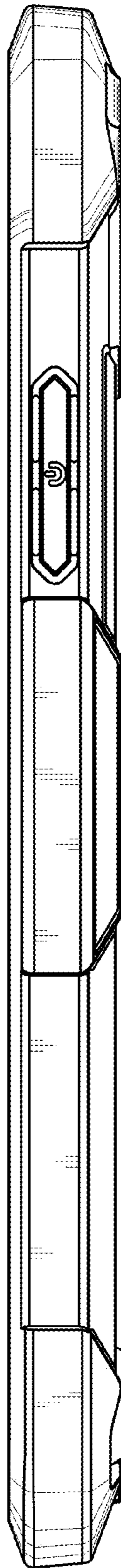

FIG. 4

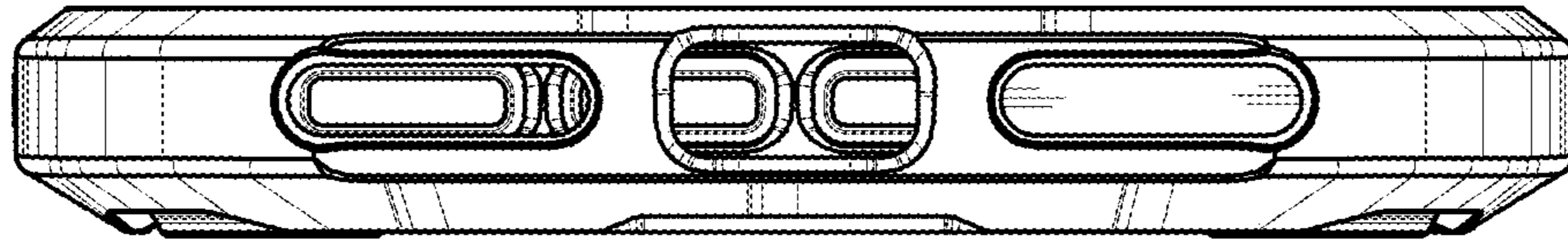

FIG. 5

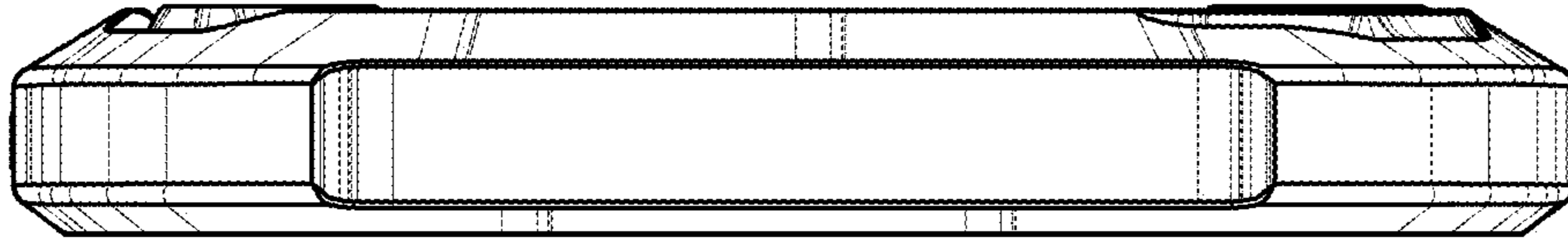

FIG. 6

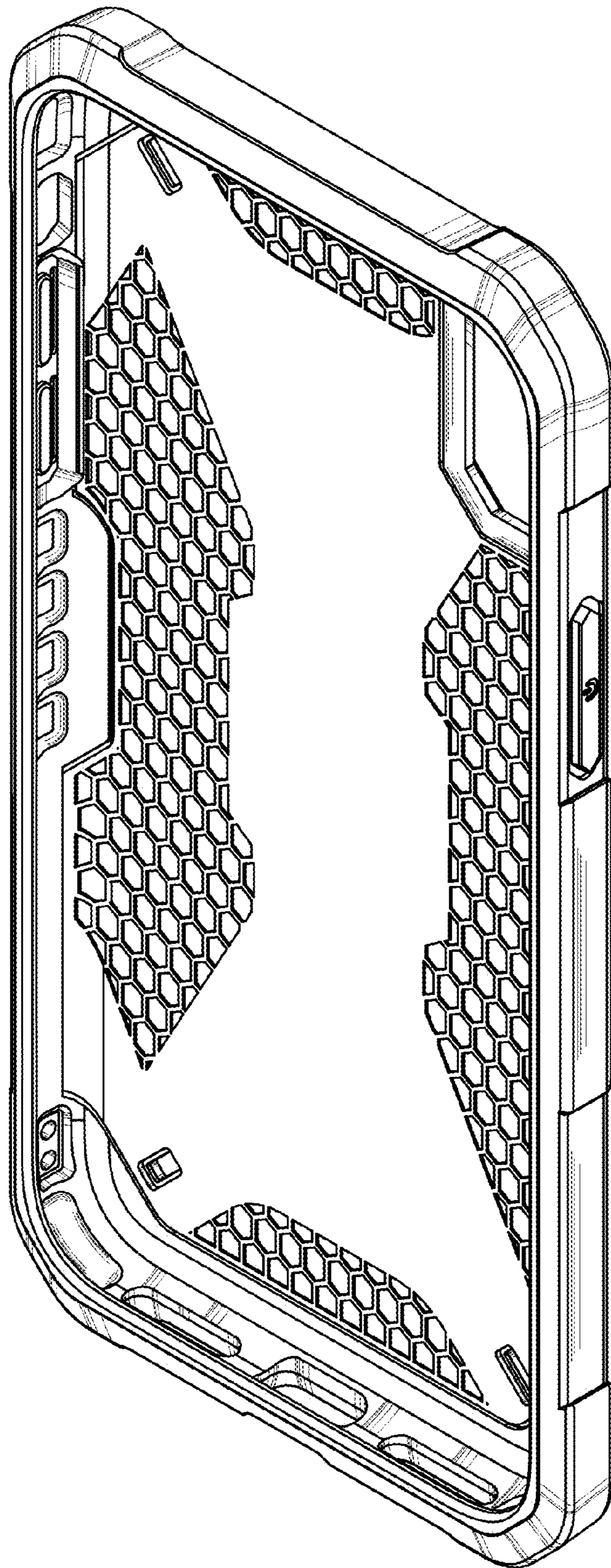

FIG. 7



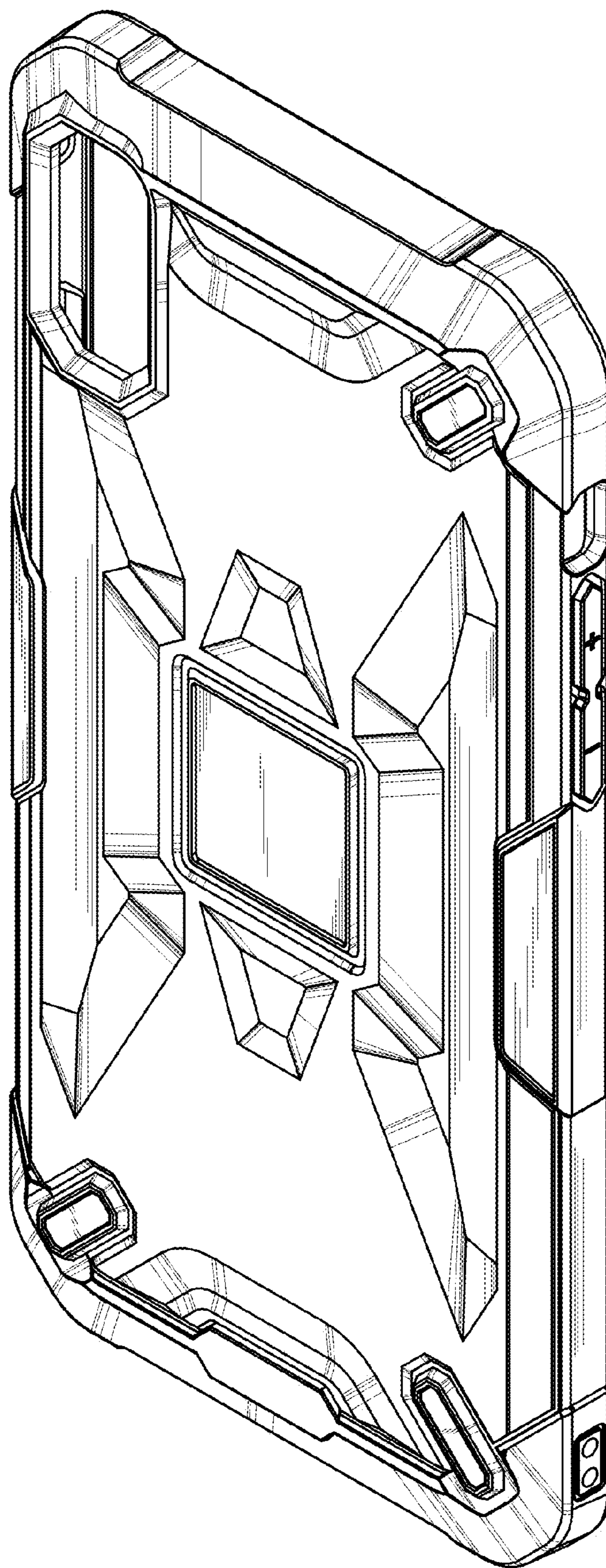

FIG. 8